

LEGO SYSTEM

5600
RADIO CONTROL

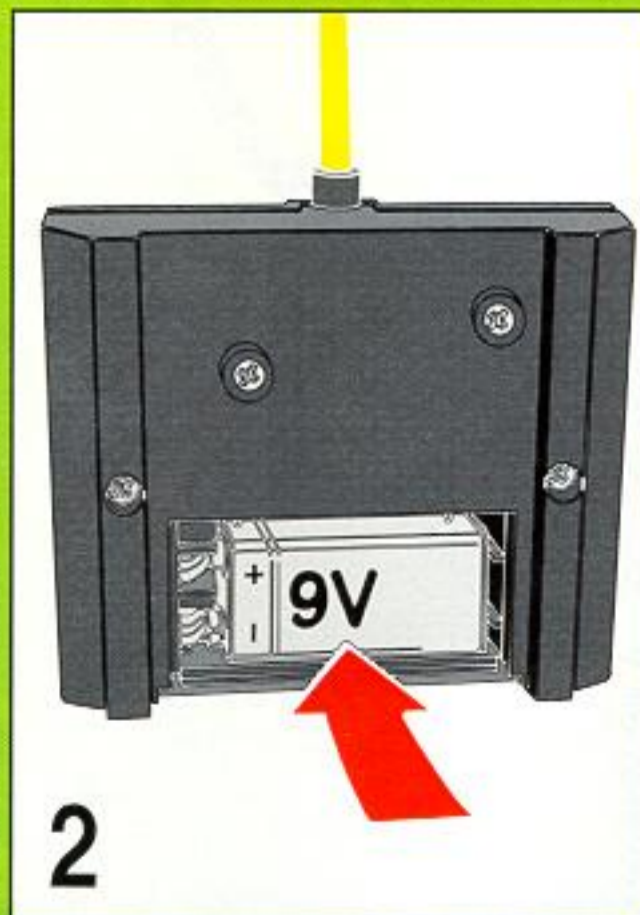

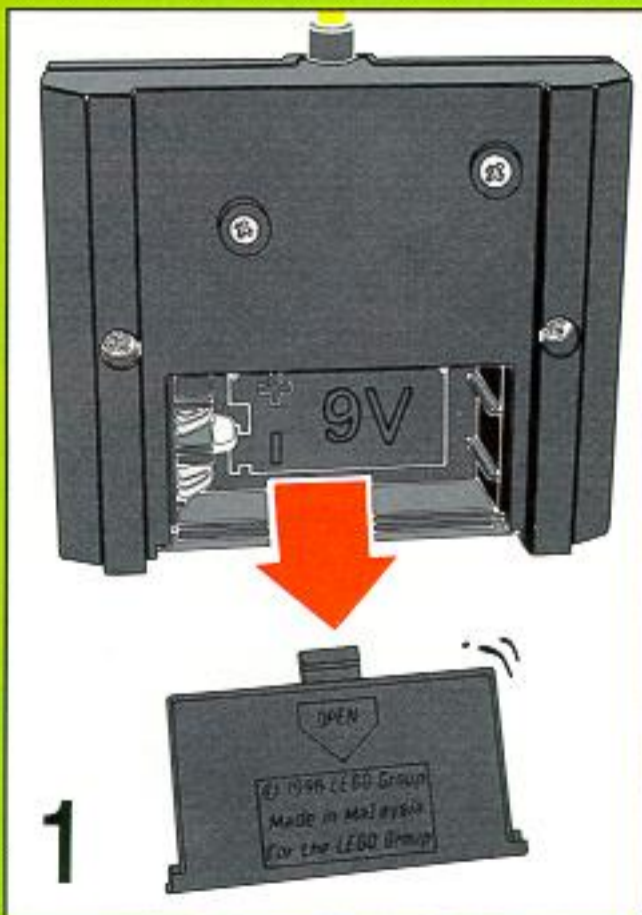

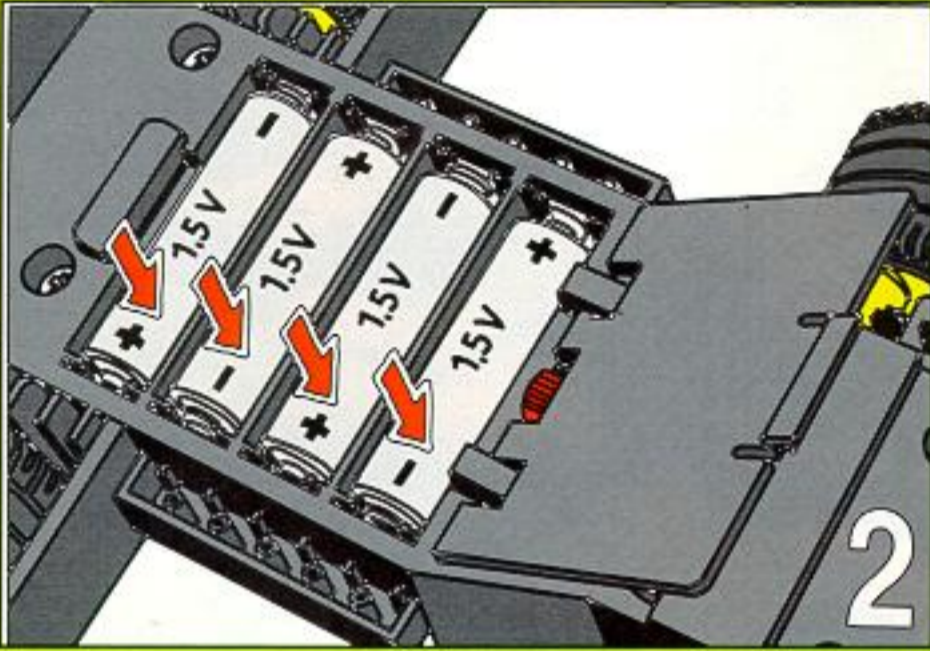
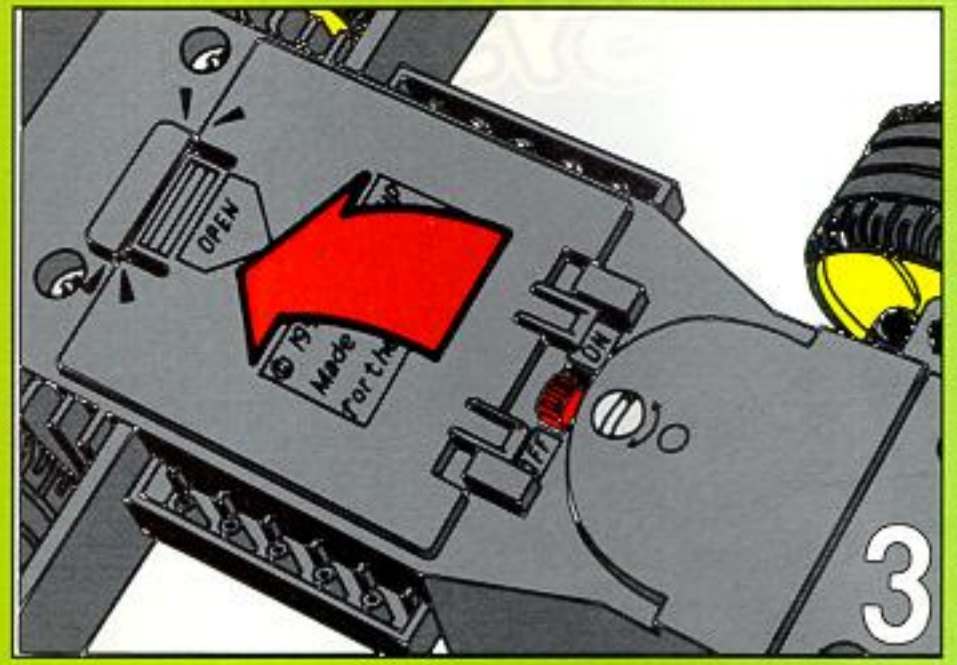
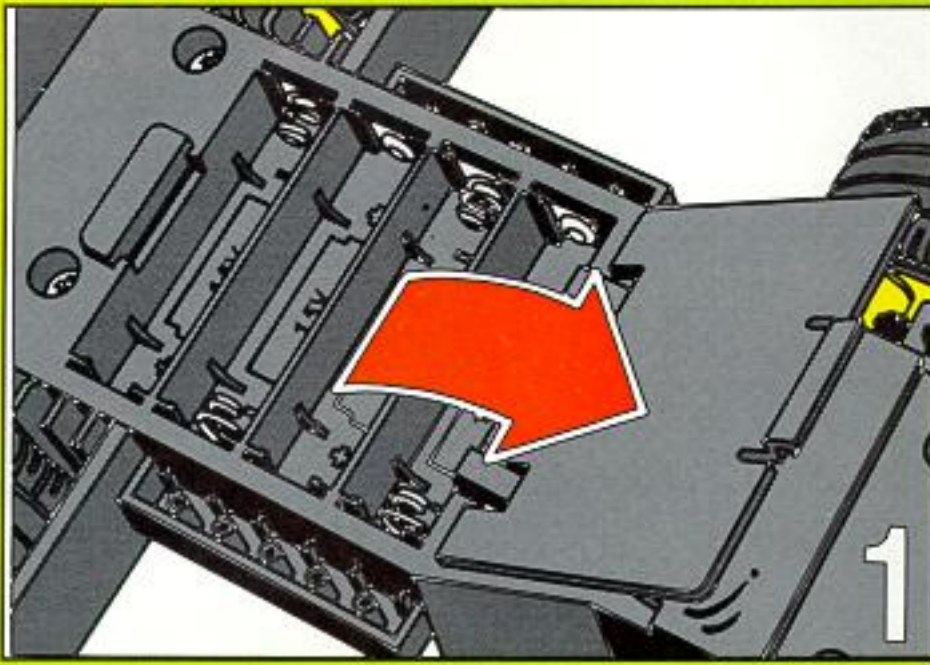
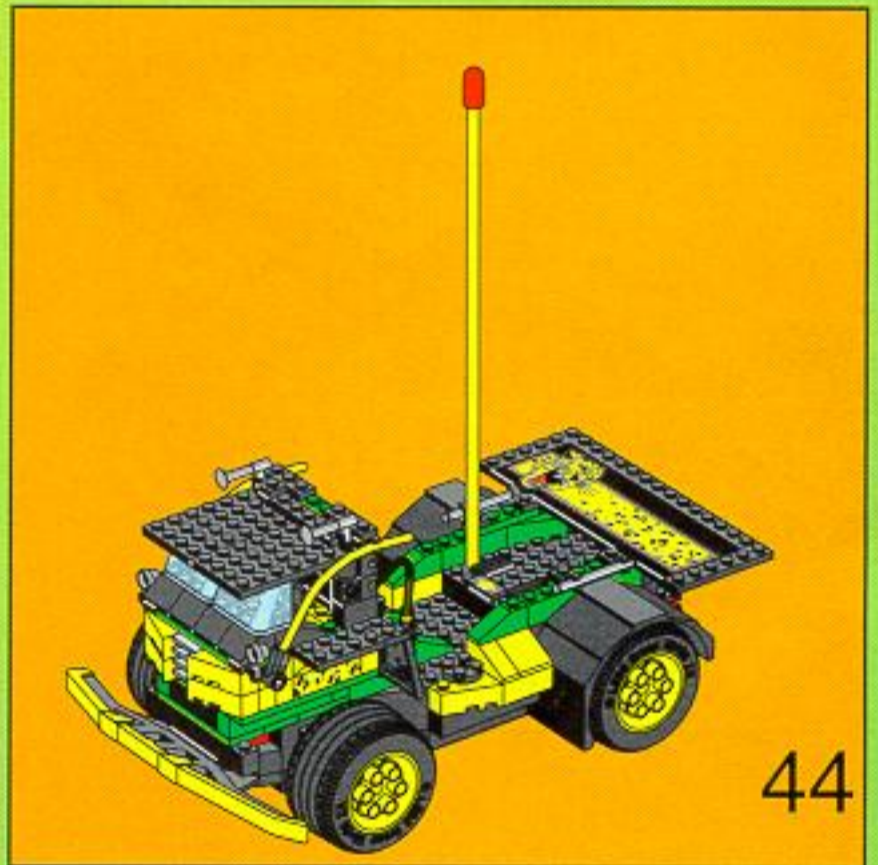
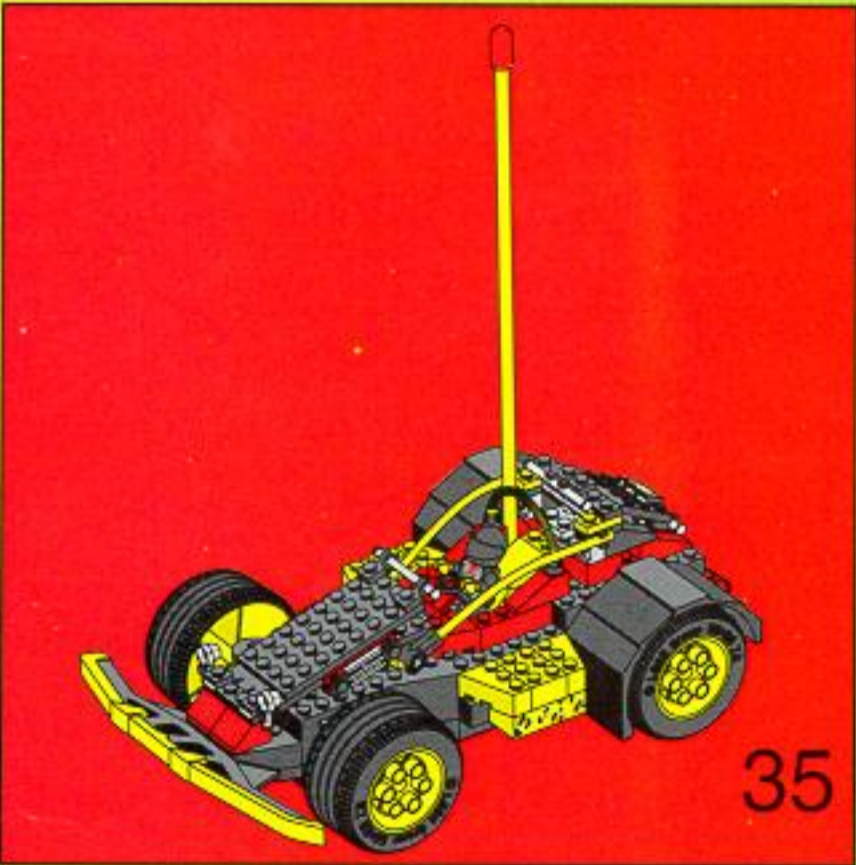
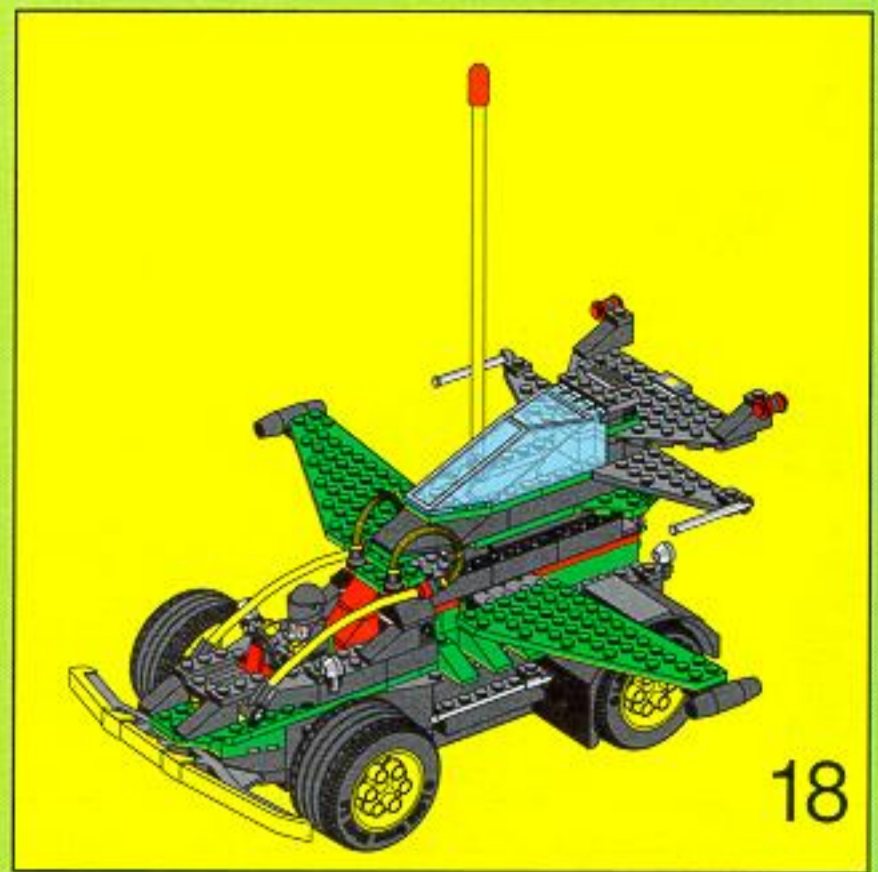
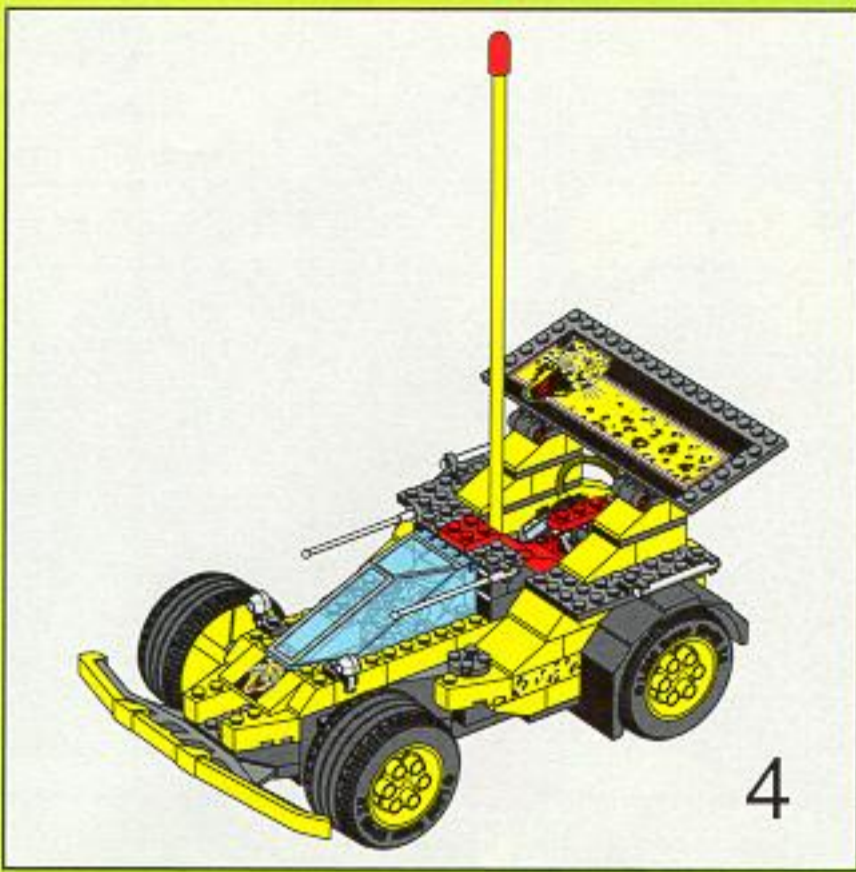

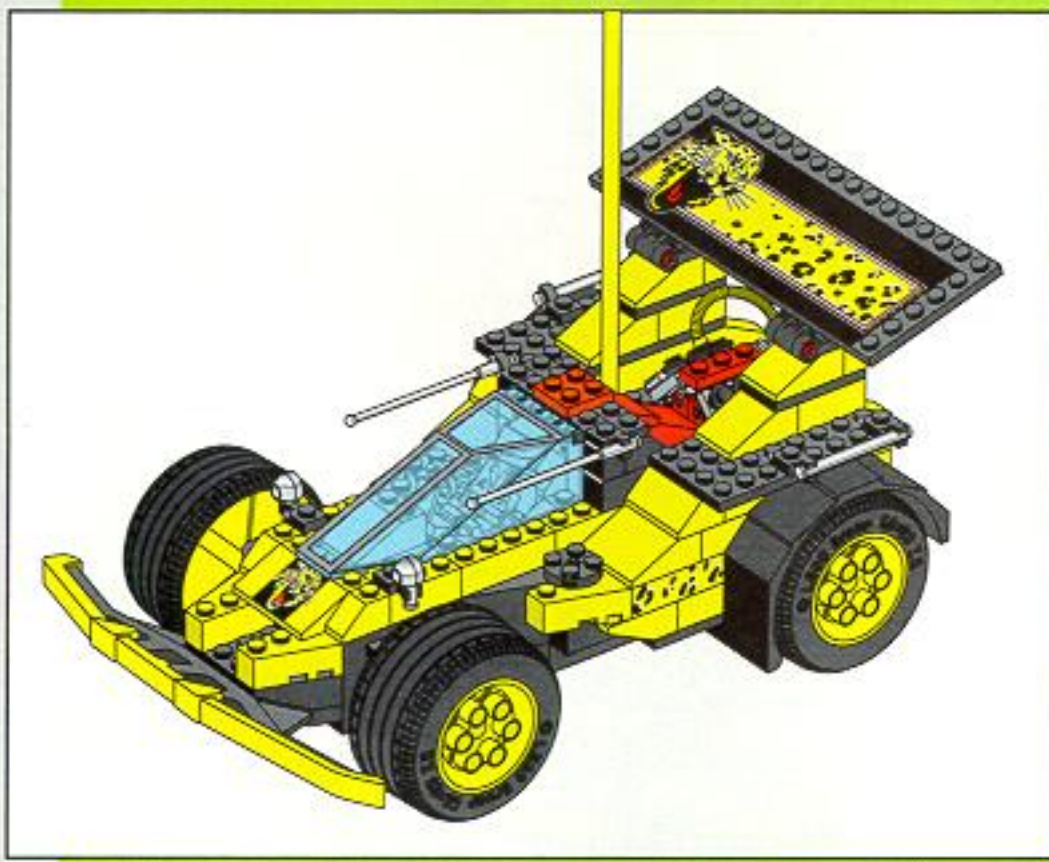
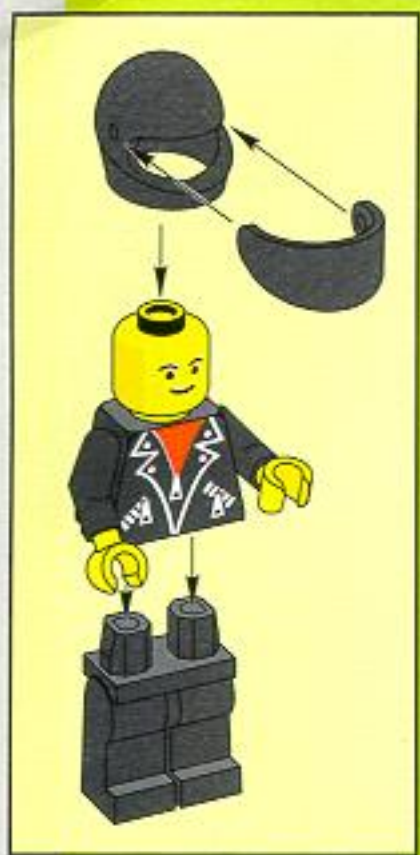

1

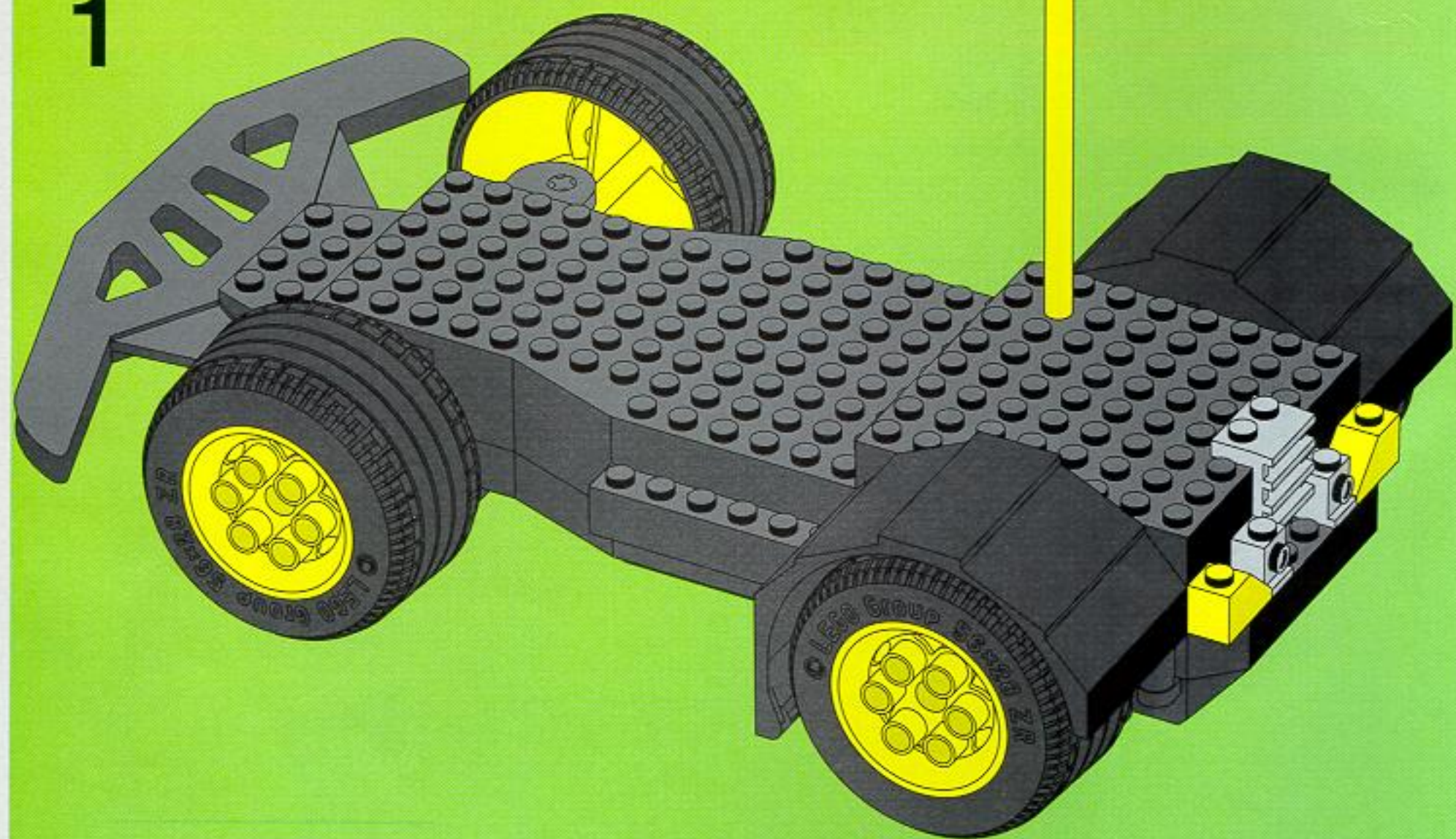

2

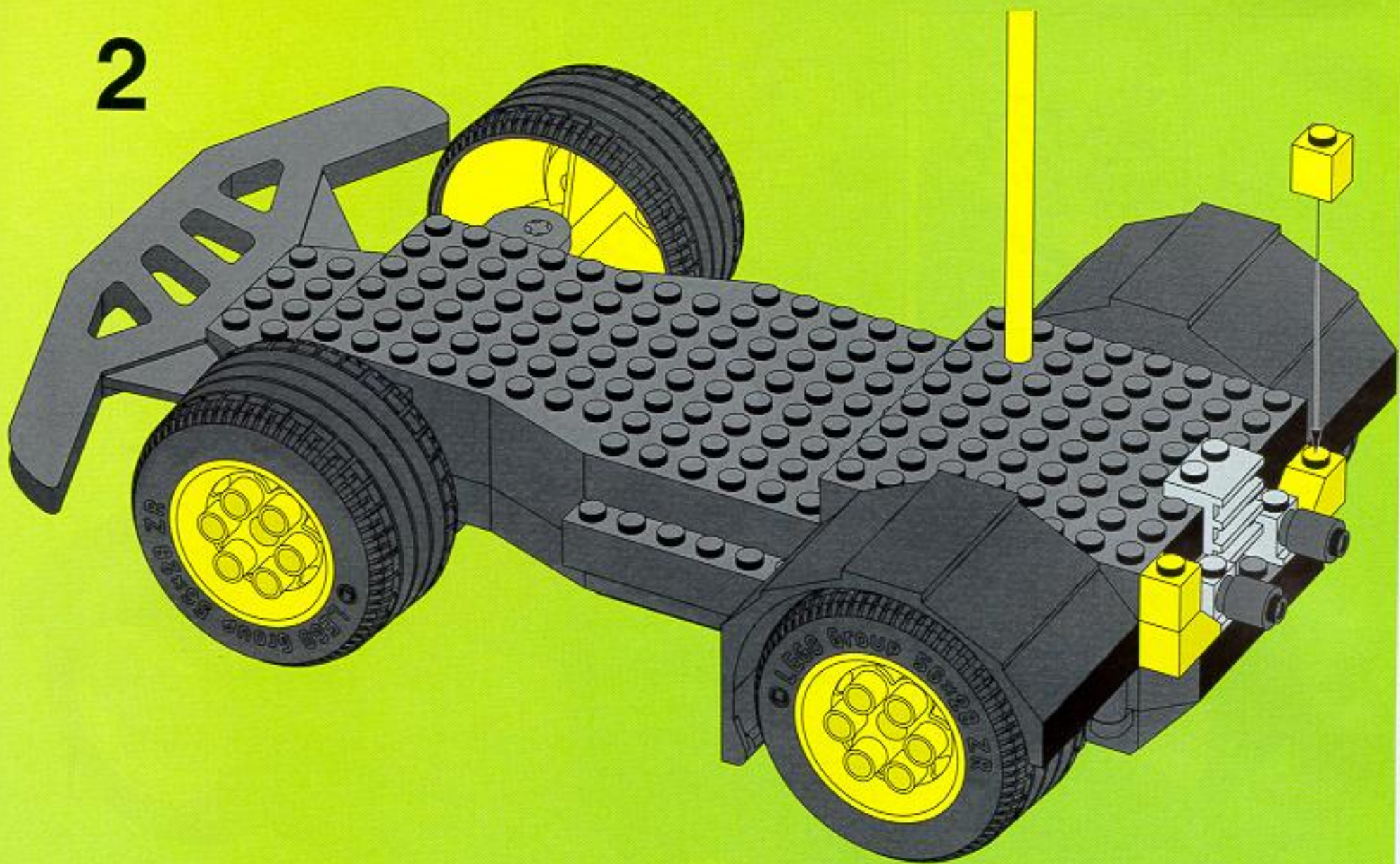

3

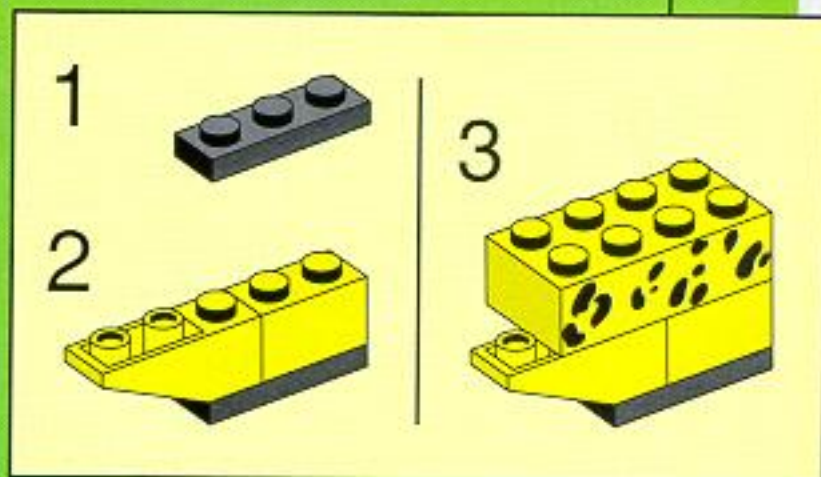
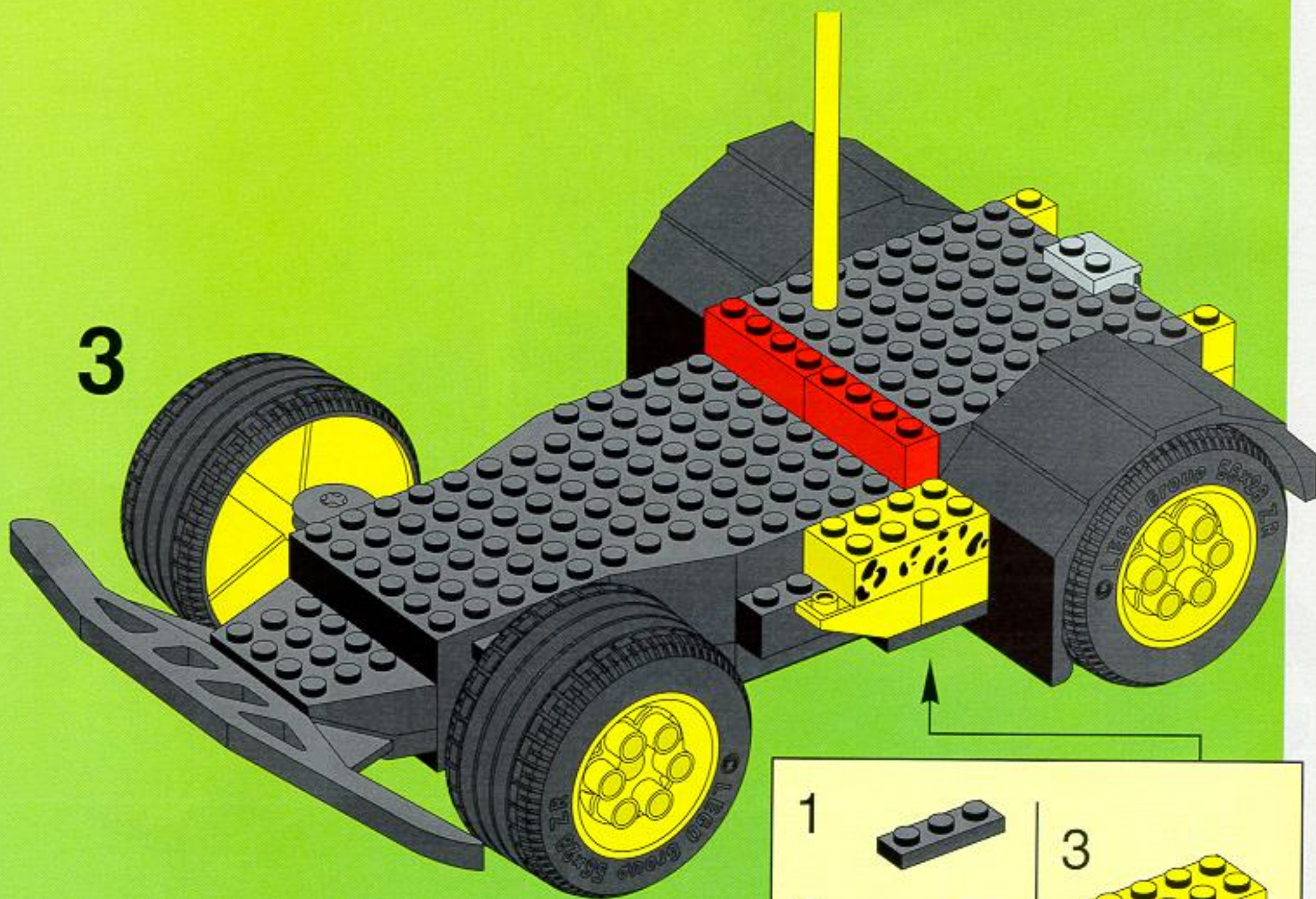

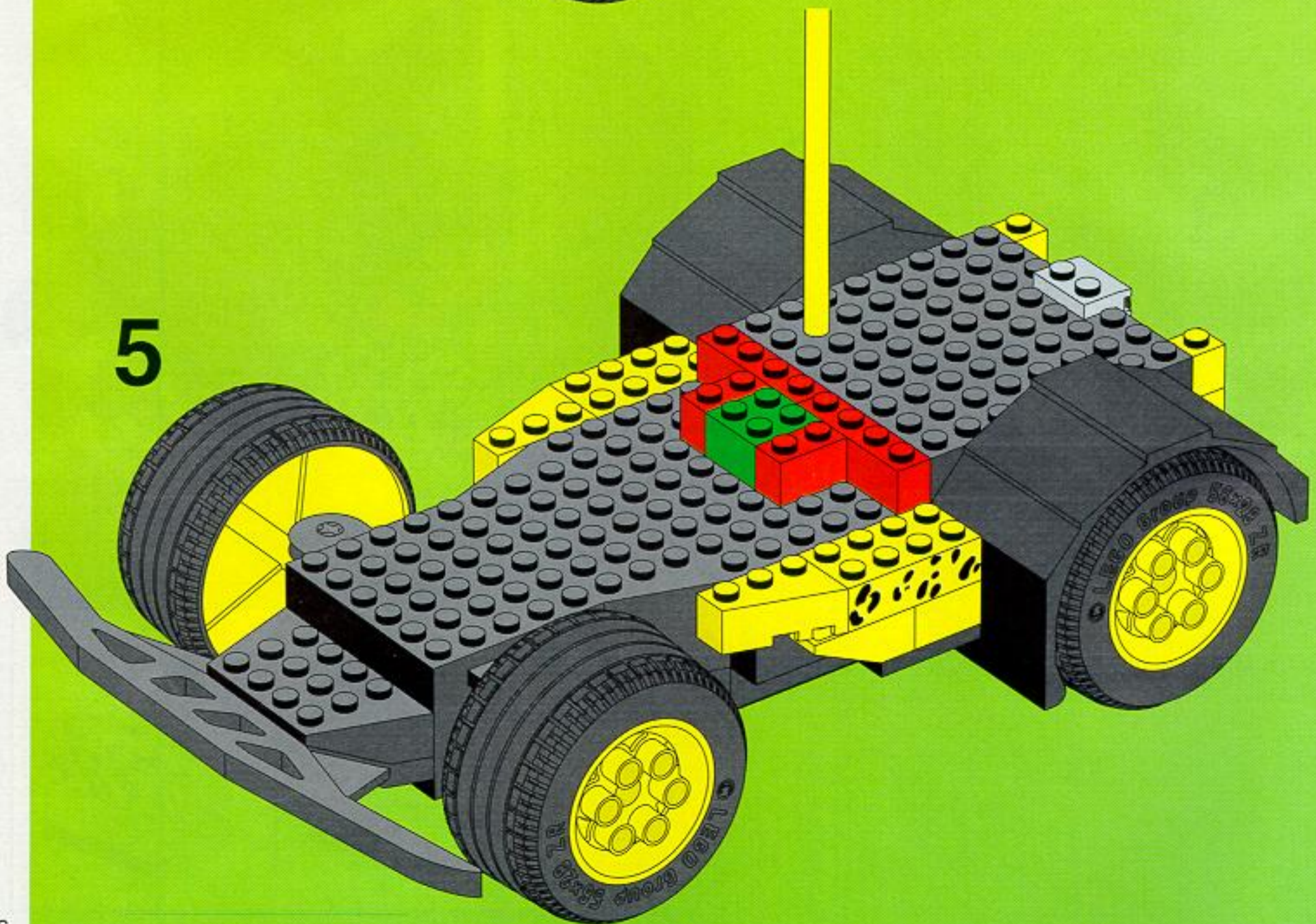
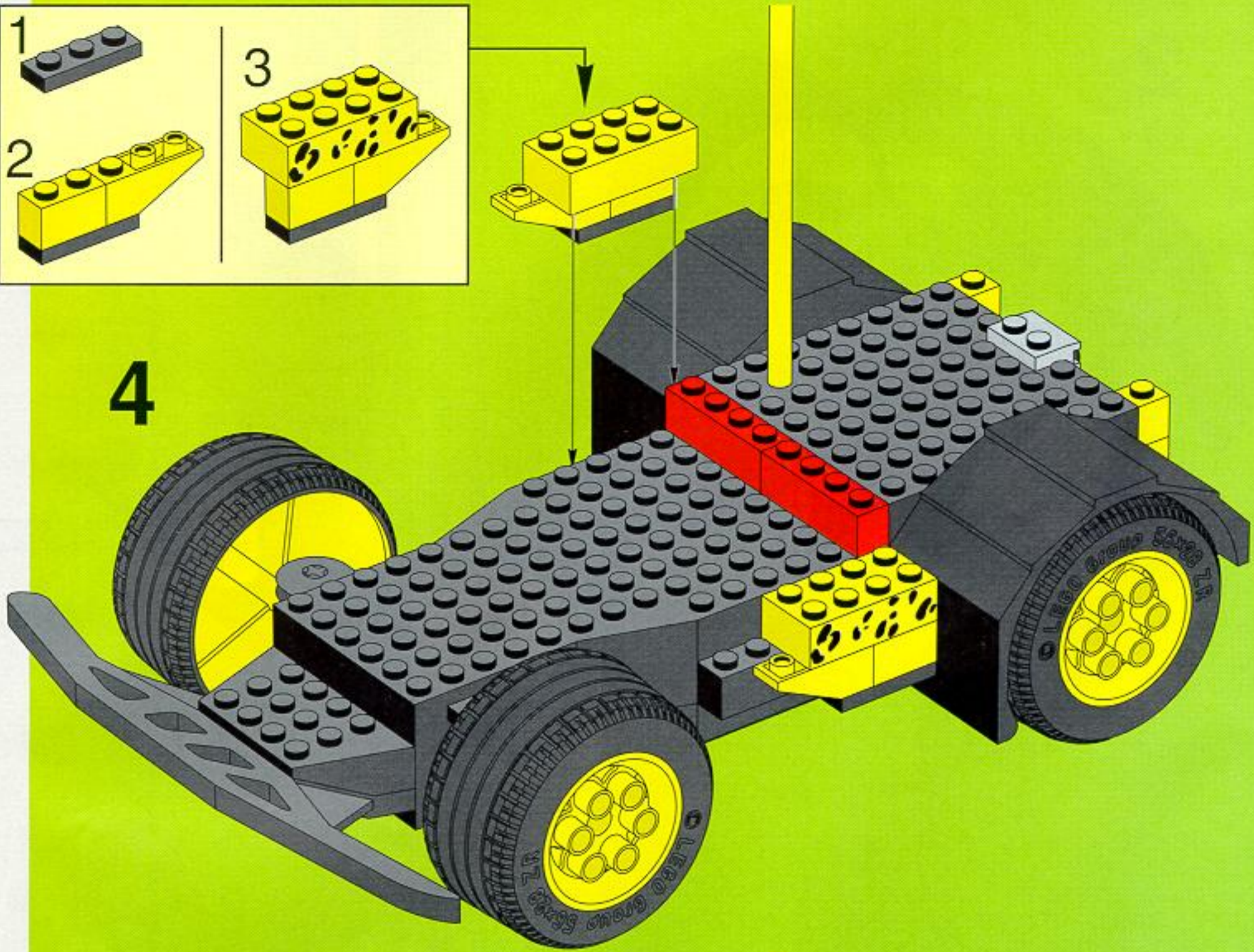
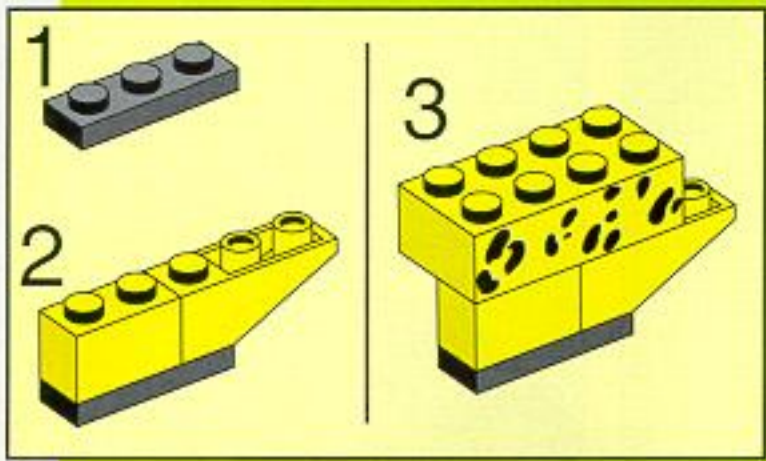

6

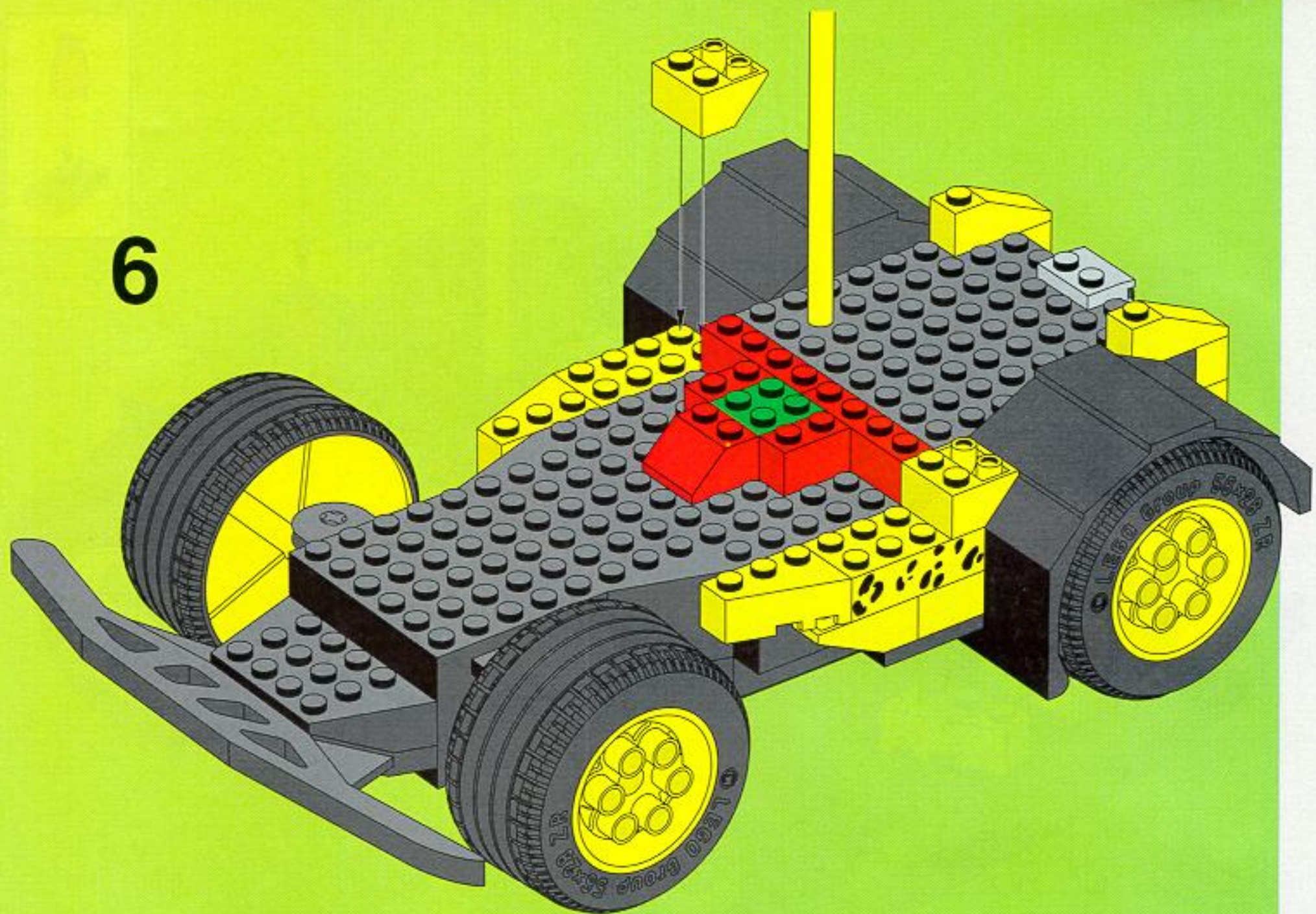

7

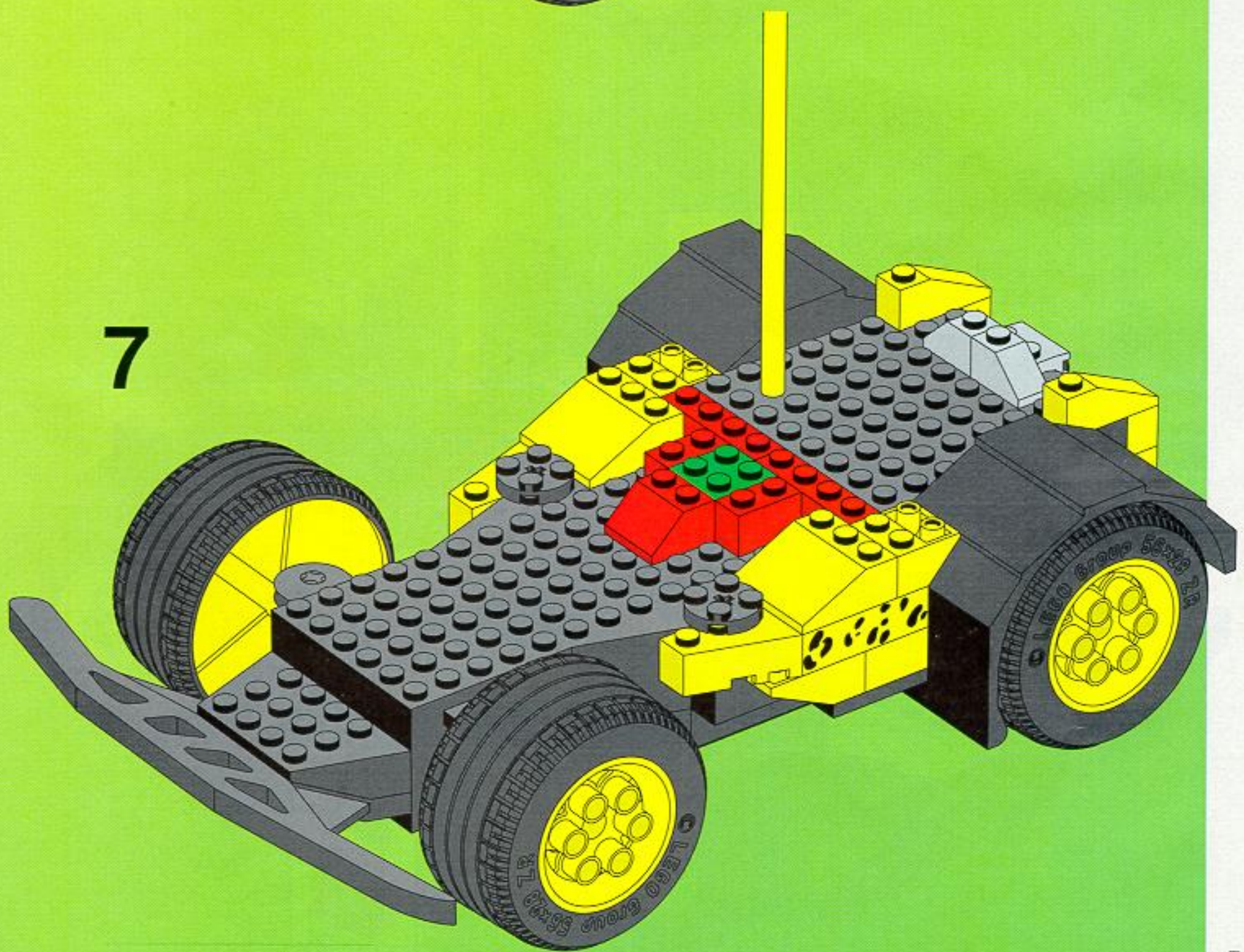

8

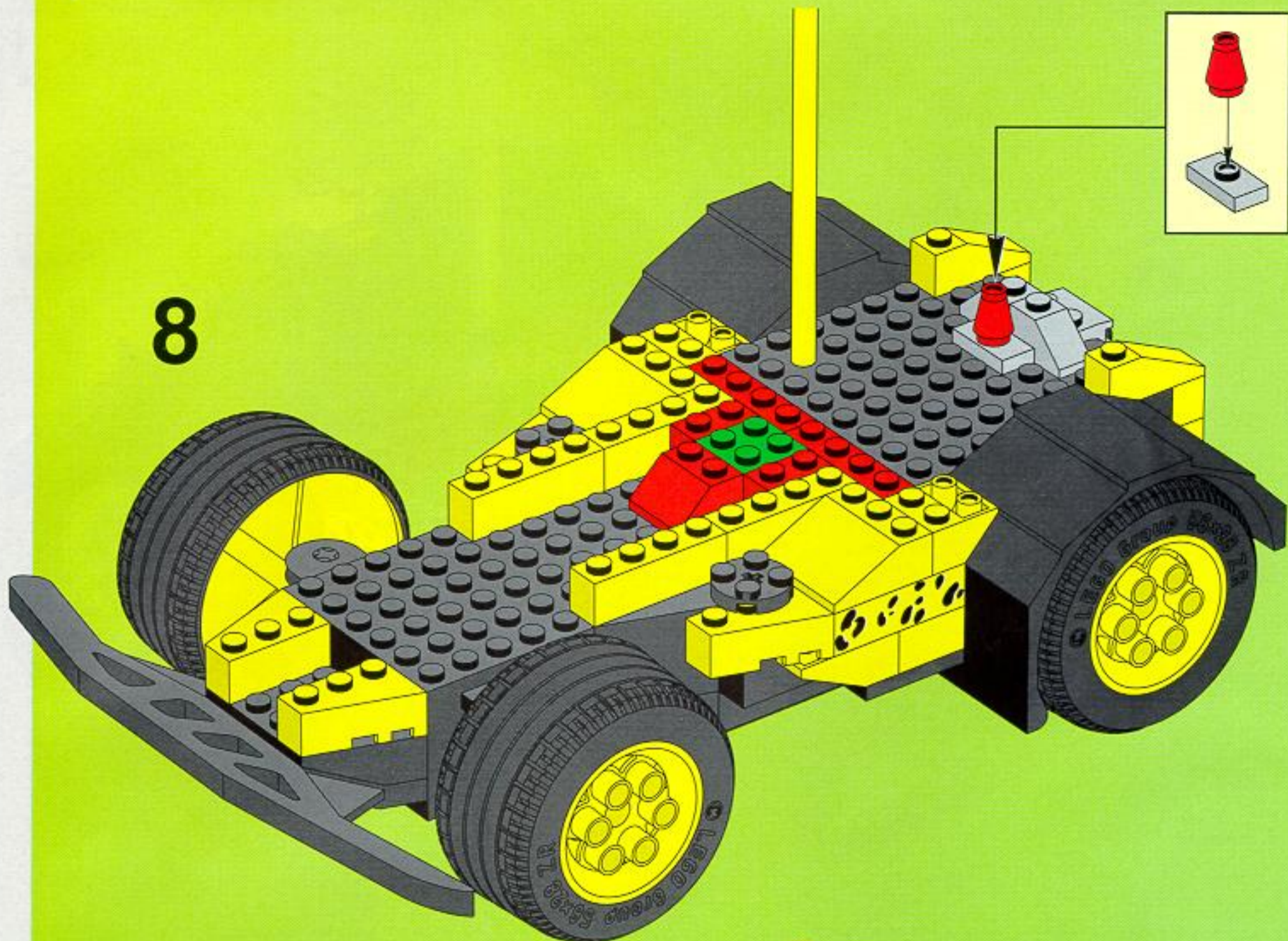

9

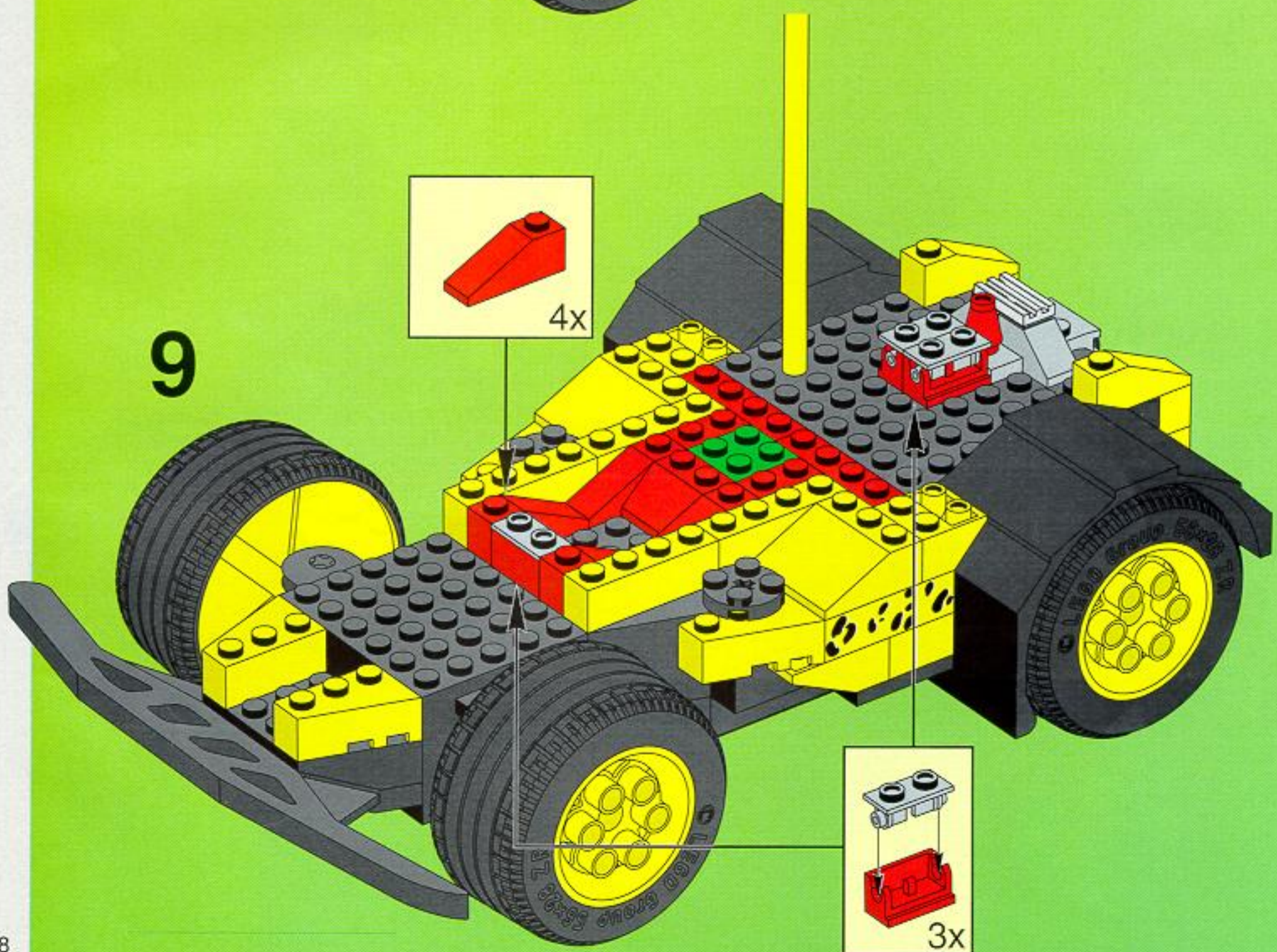

10

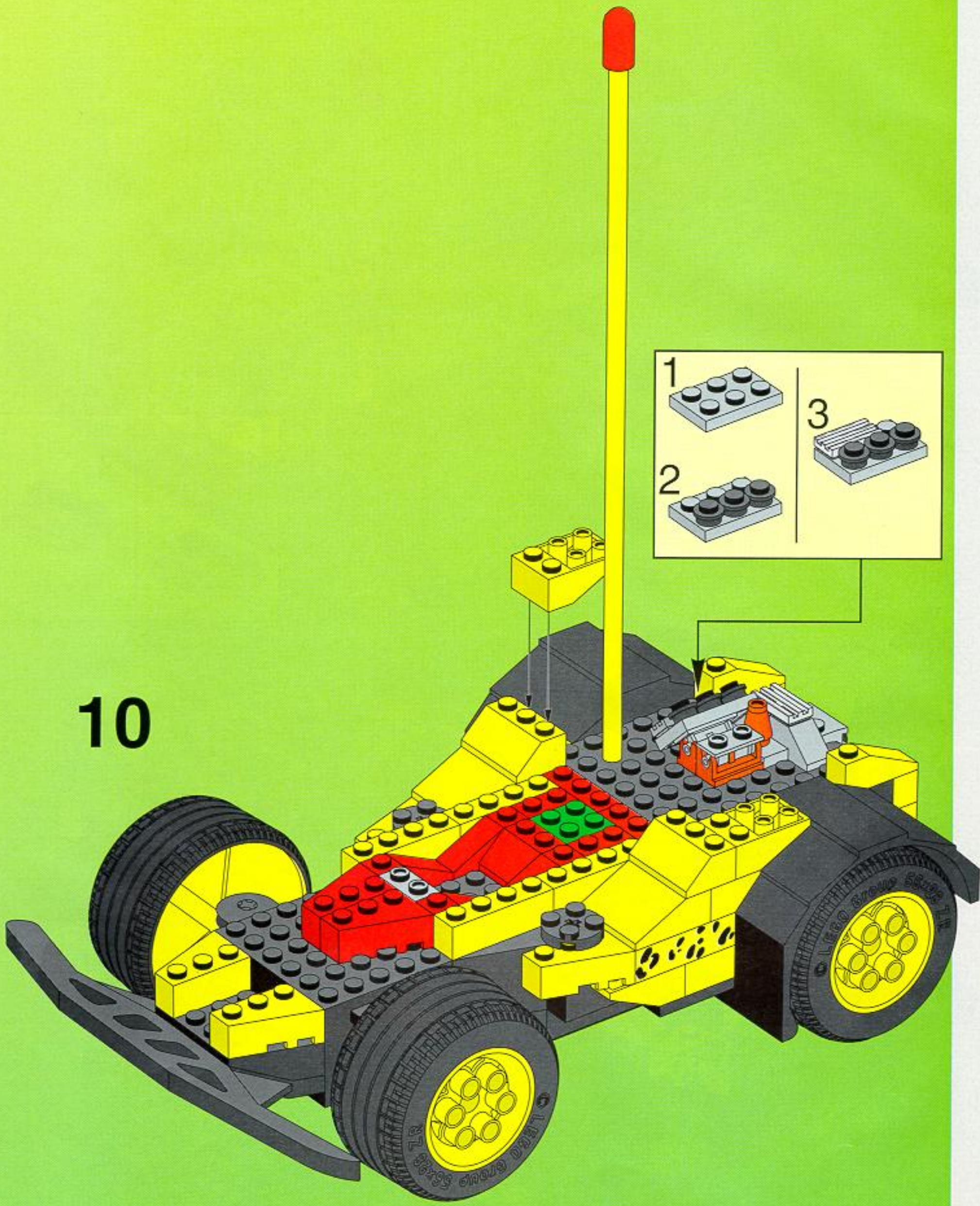

11

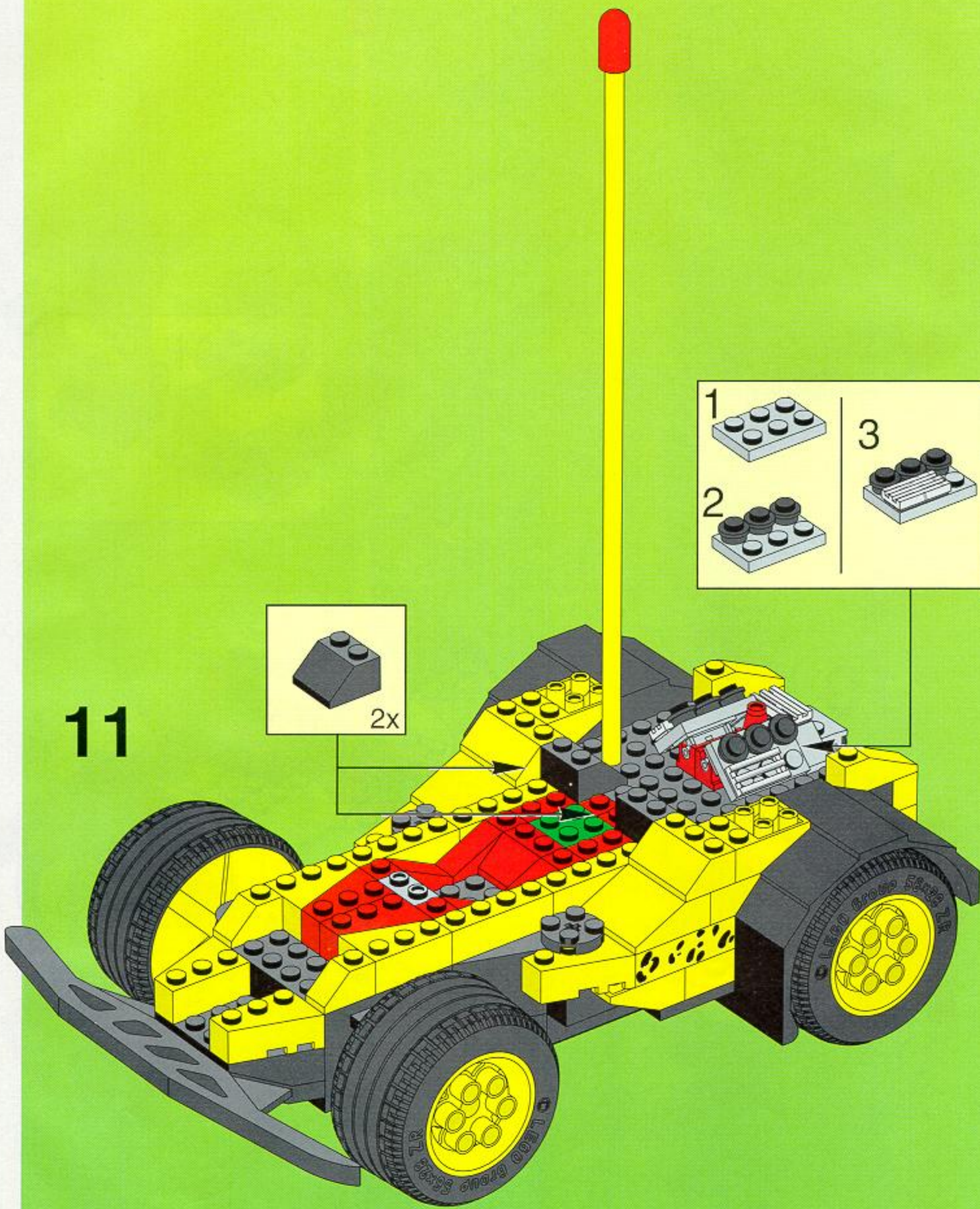
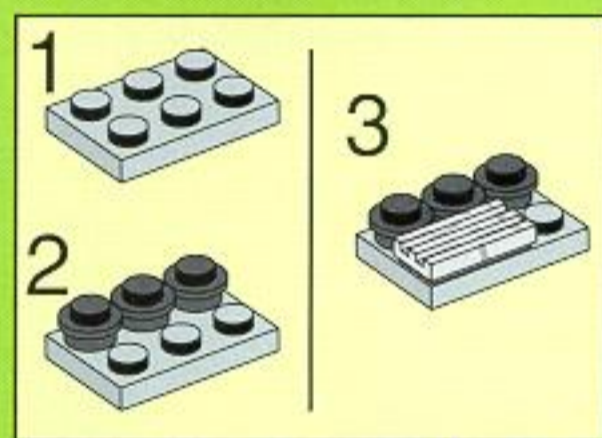

12

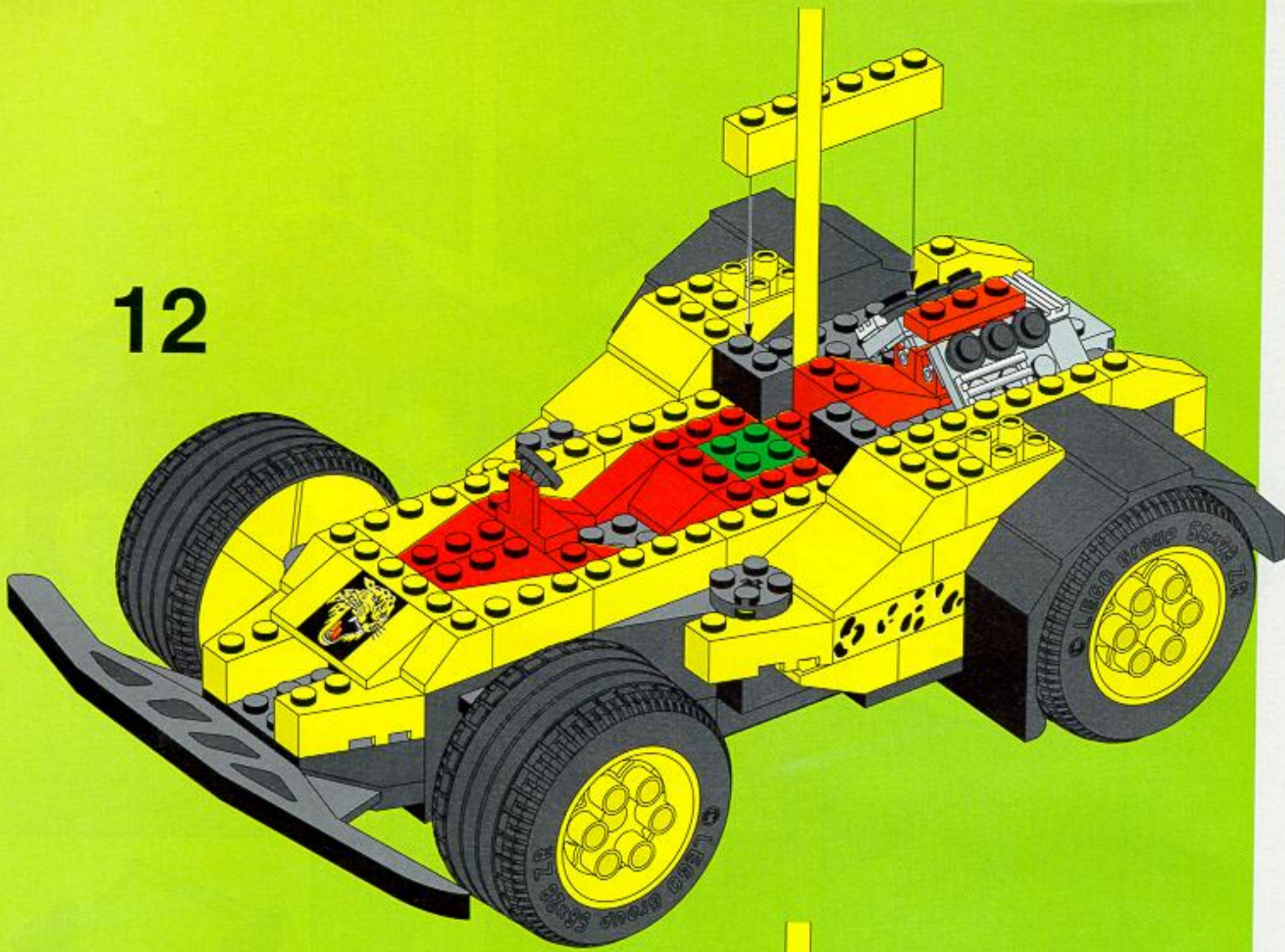

13

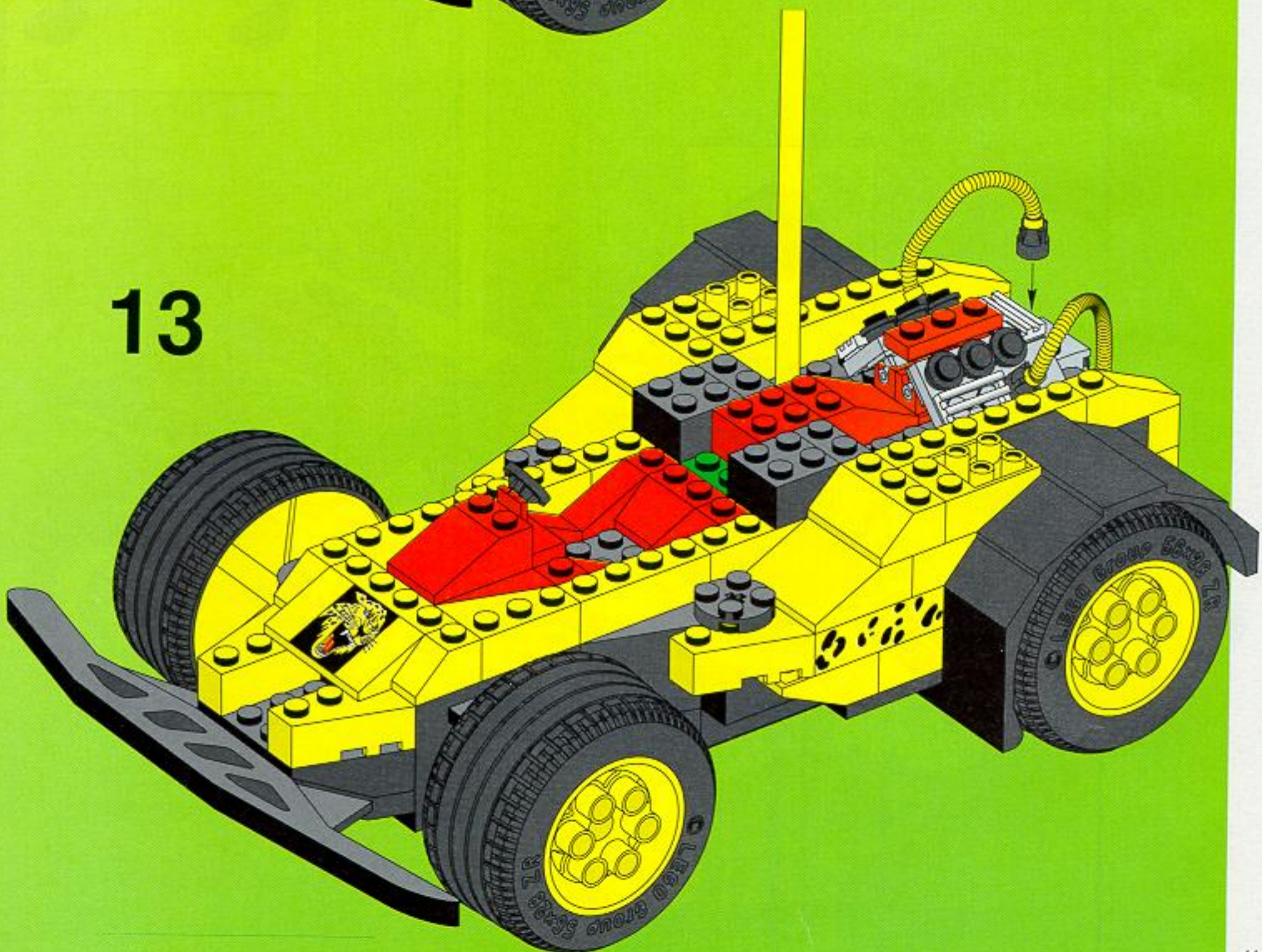

14

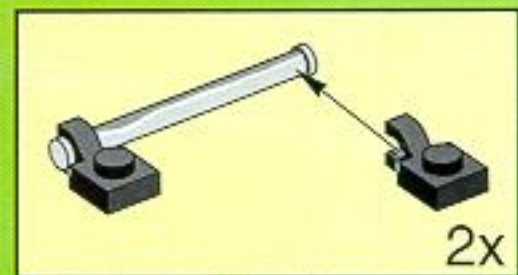
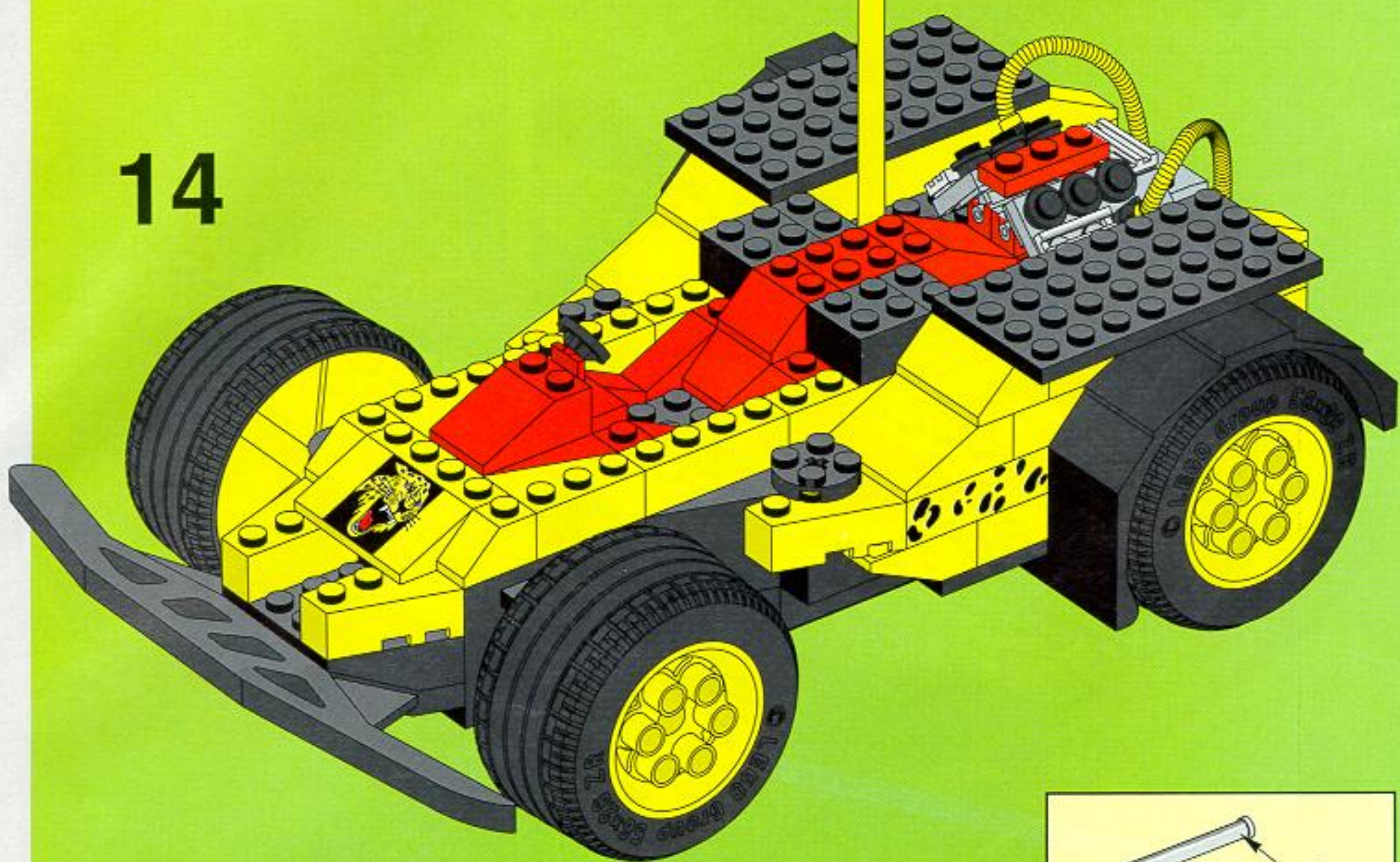

15

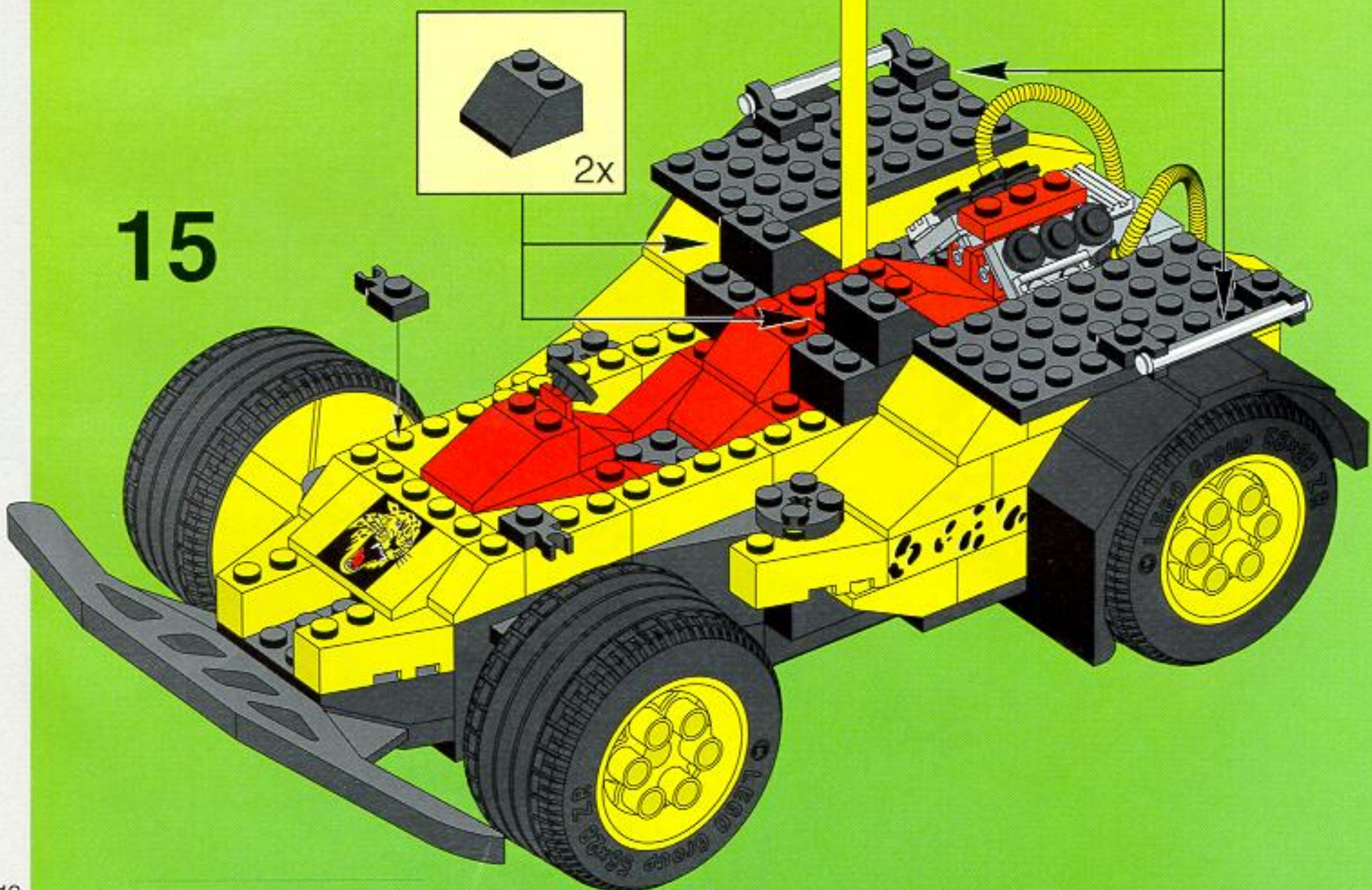

16

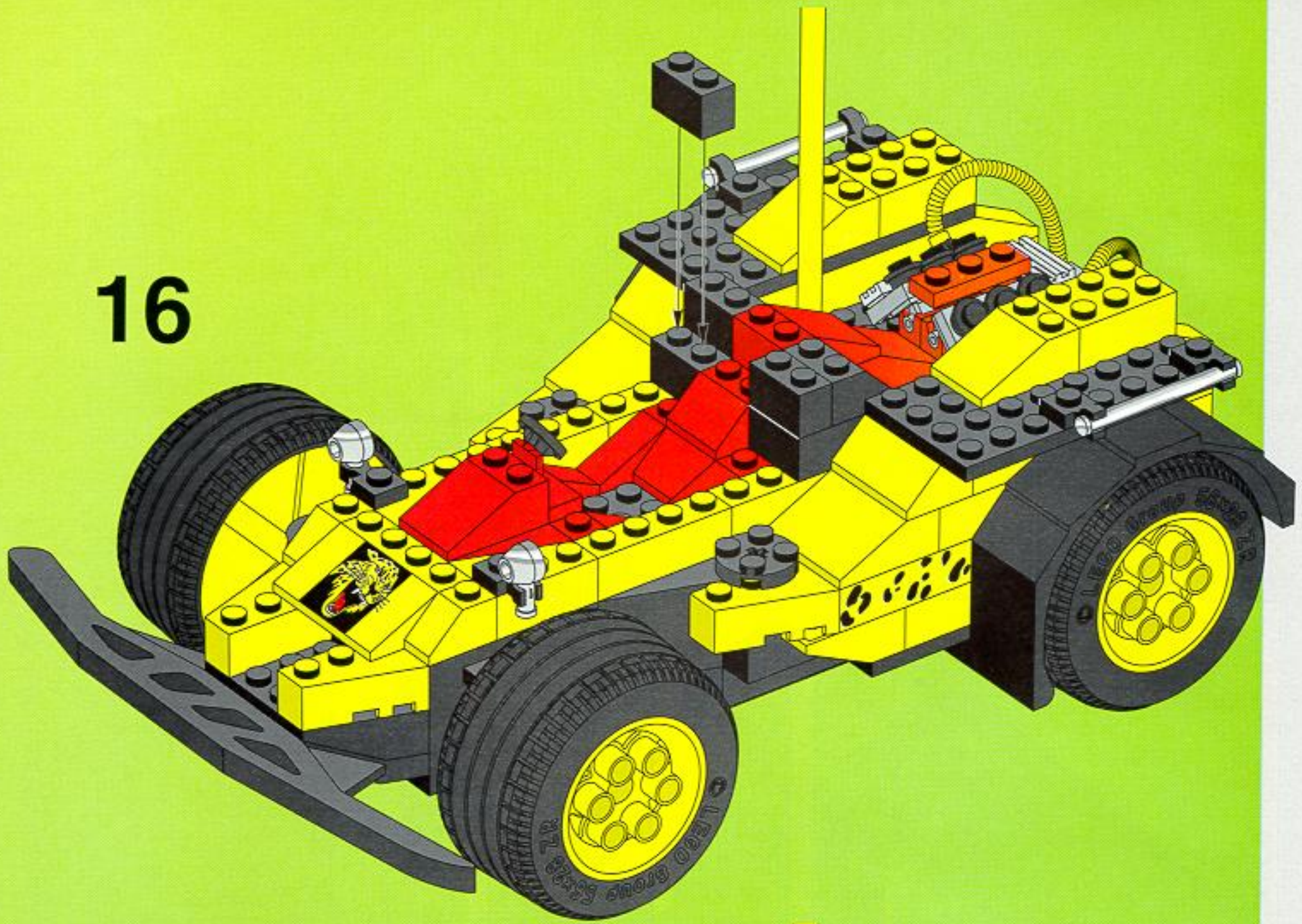

17

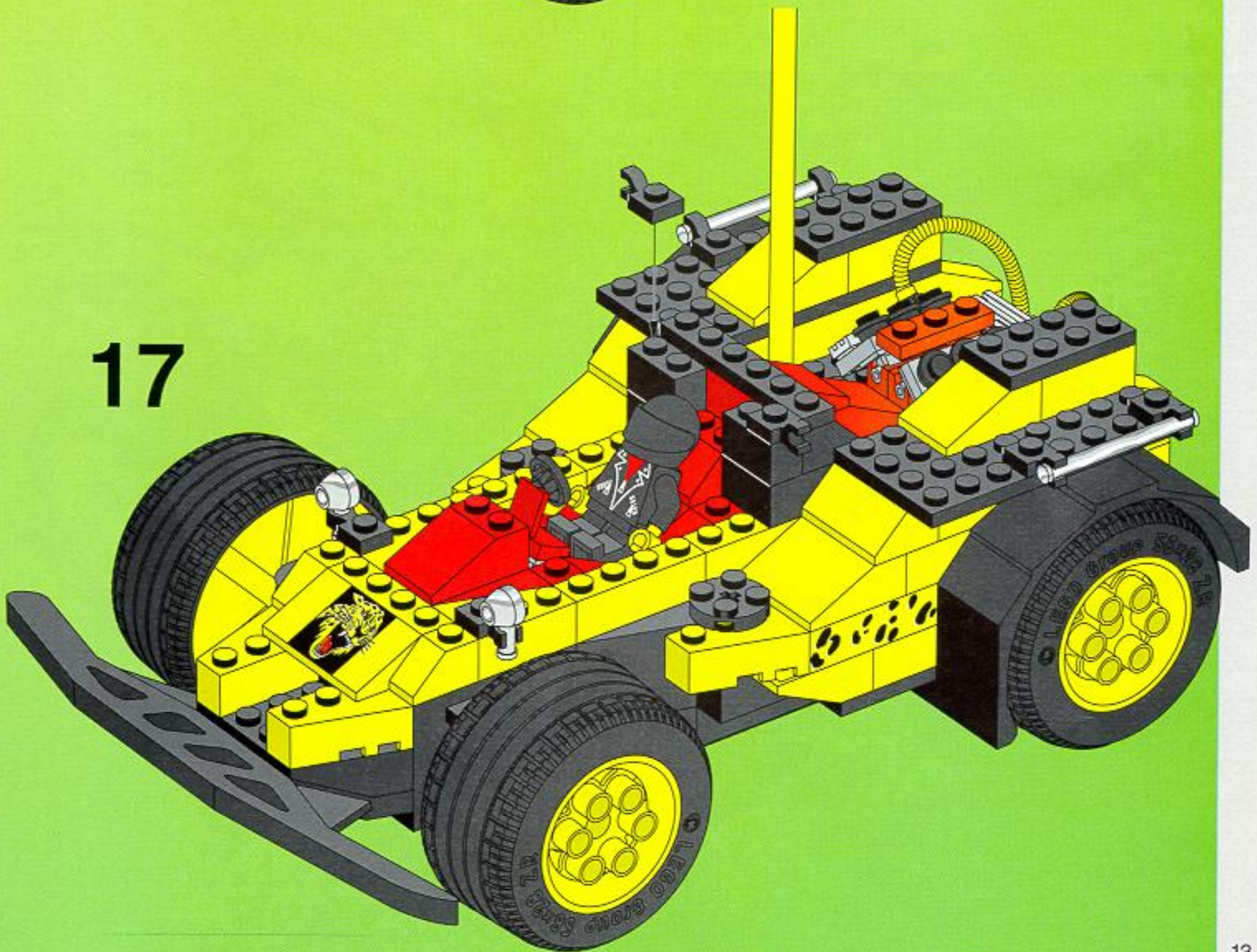

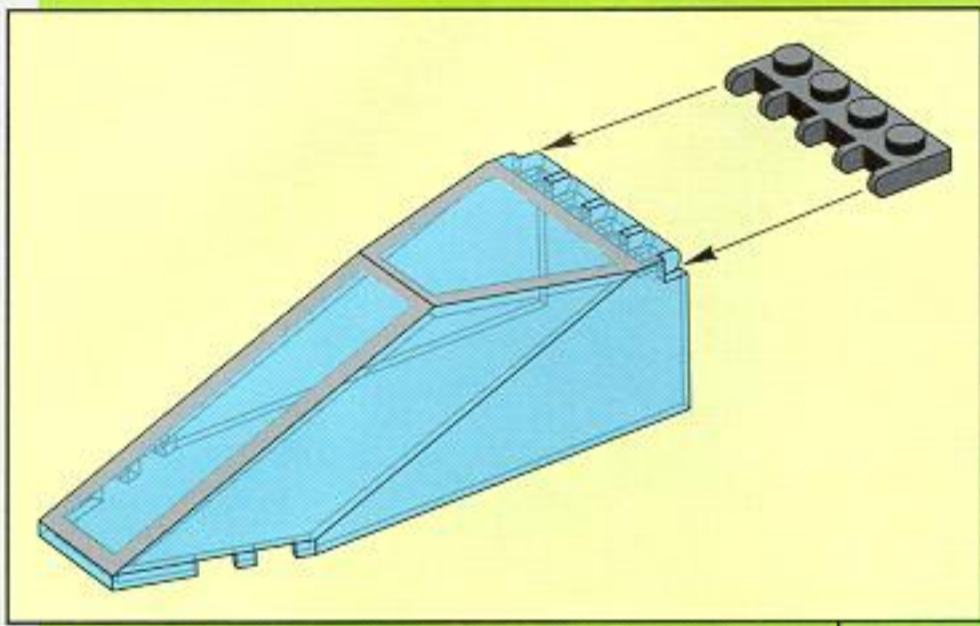

18

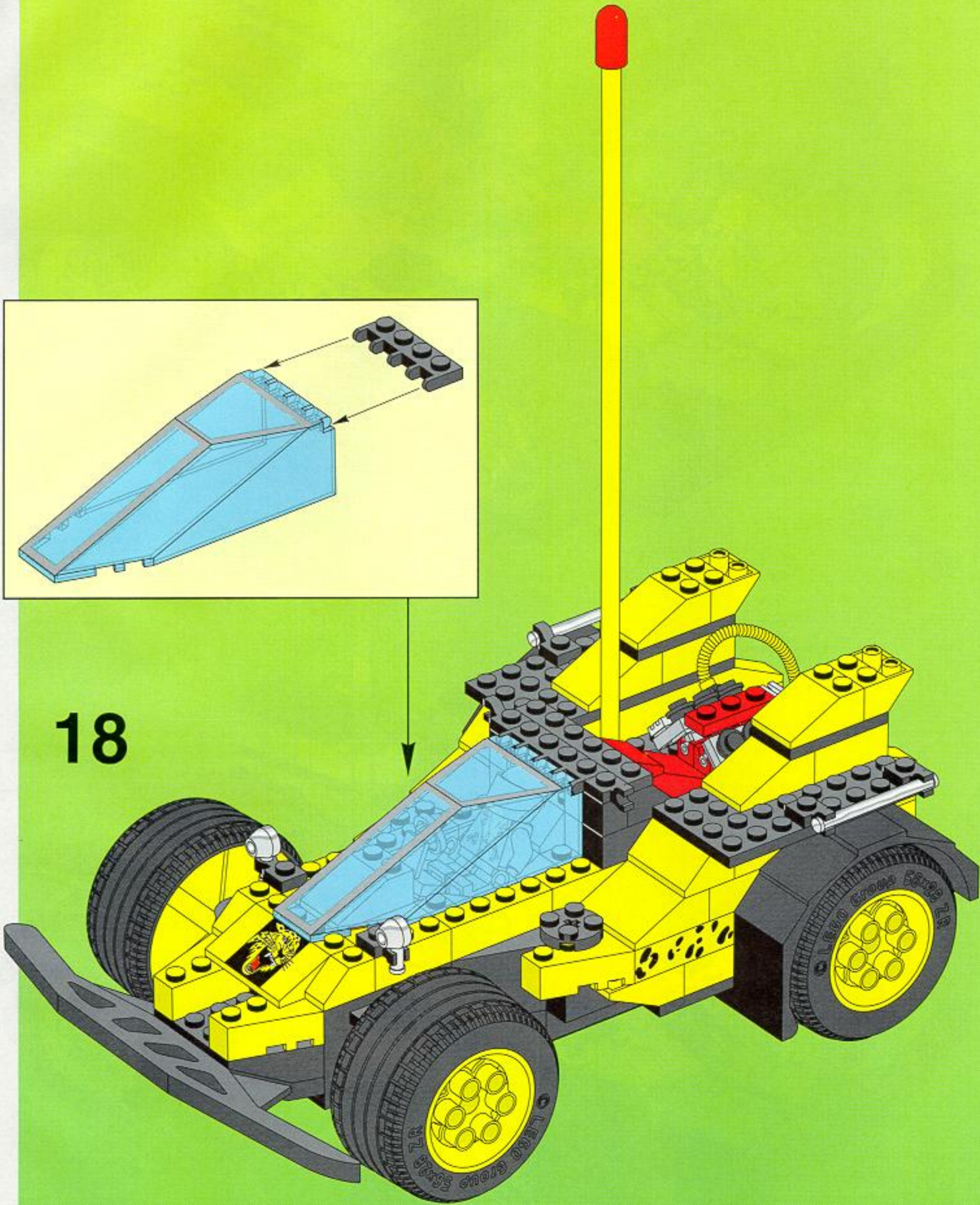

19

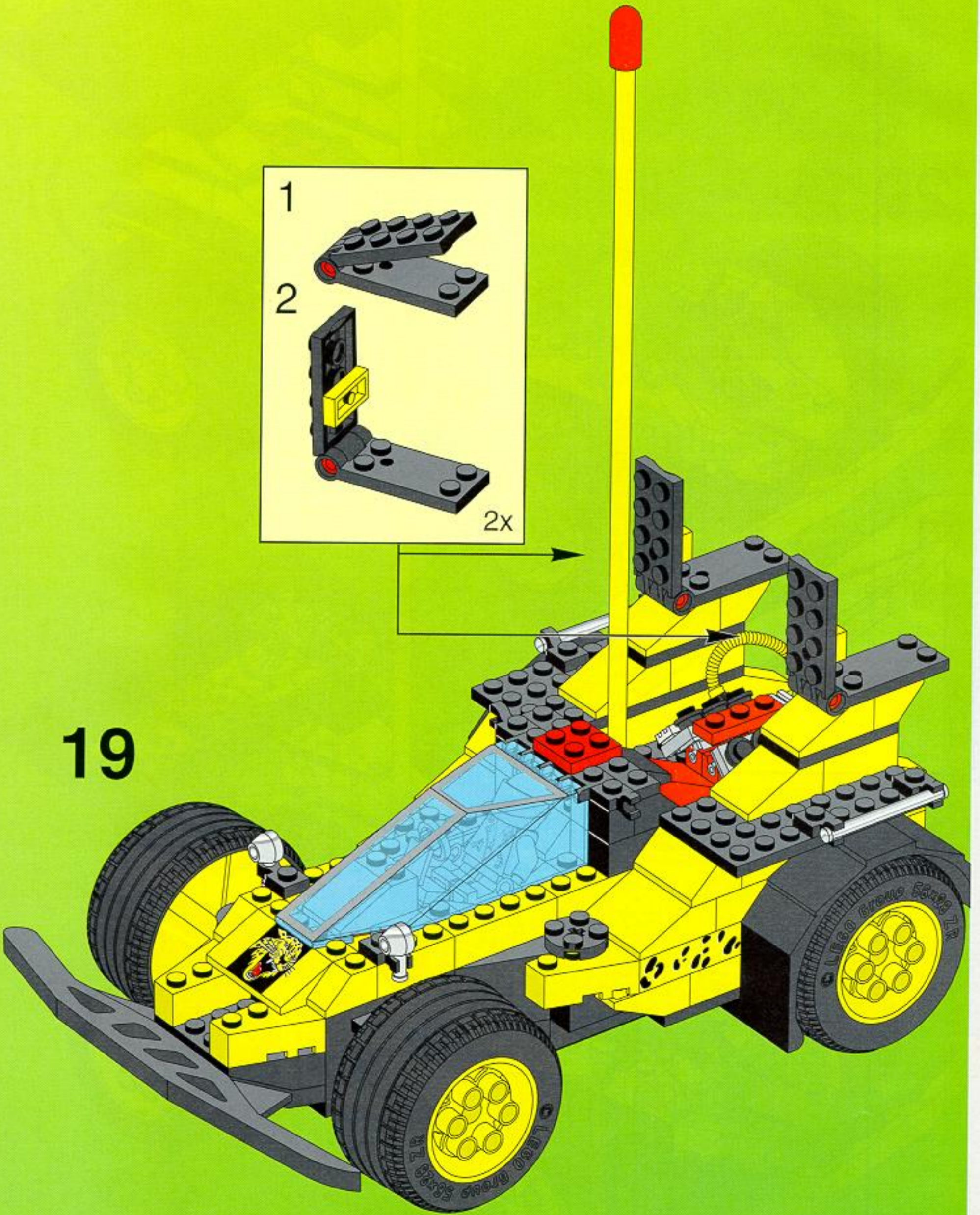
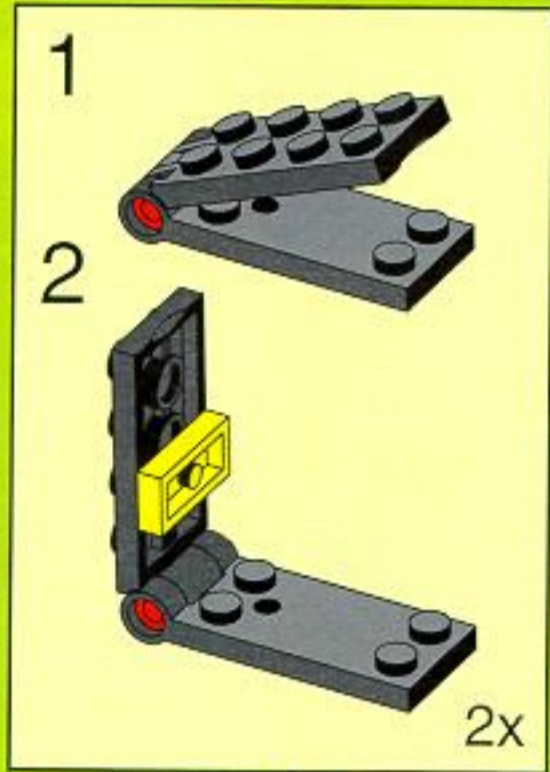

20

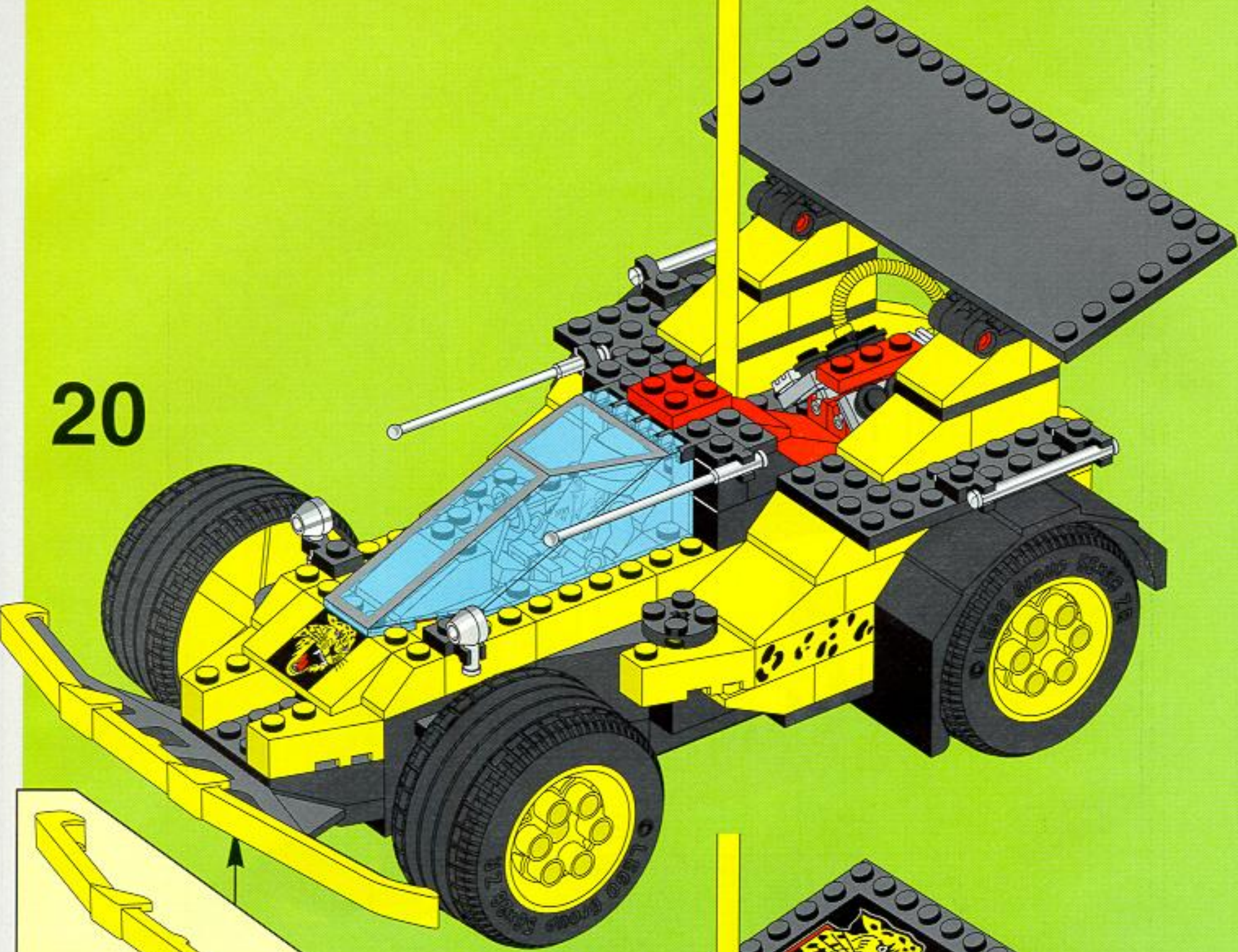

21

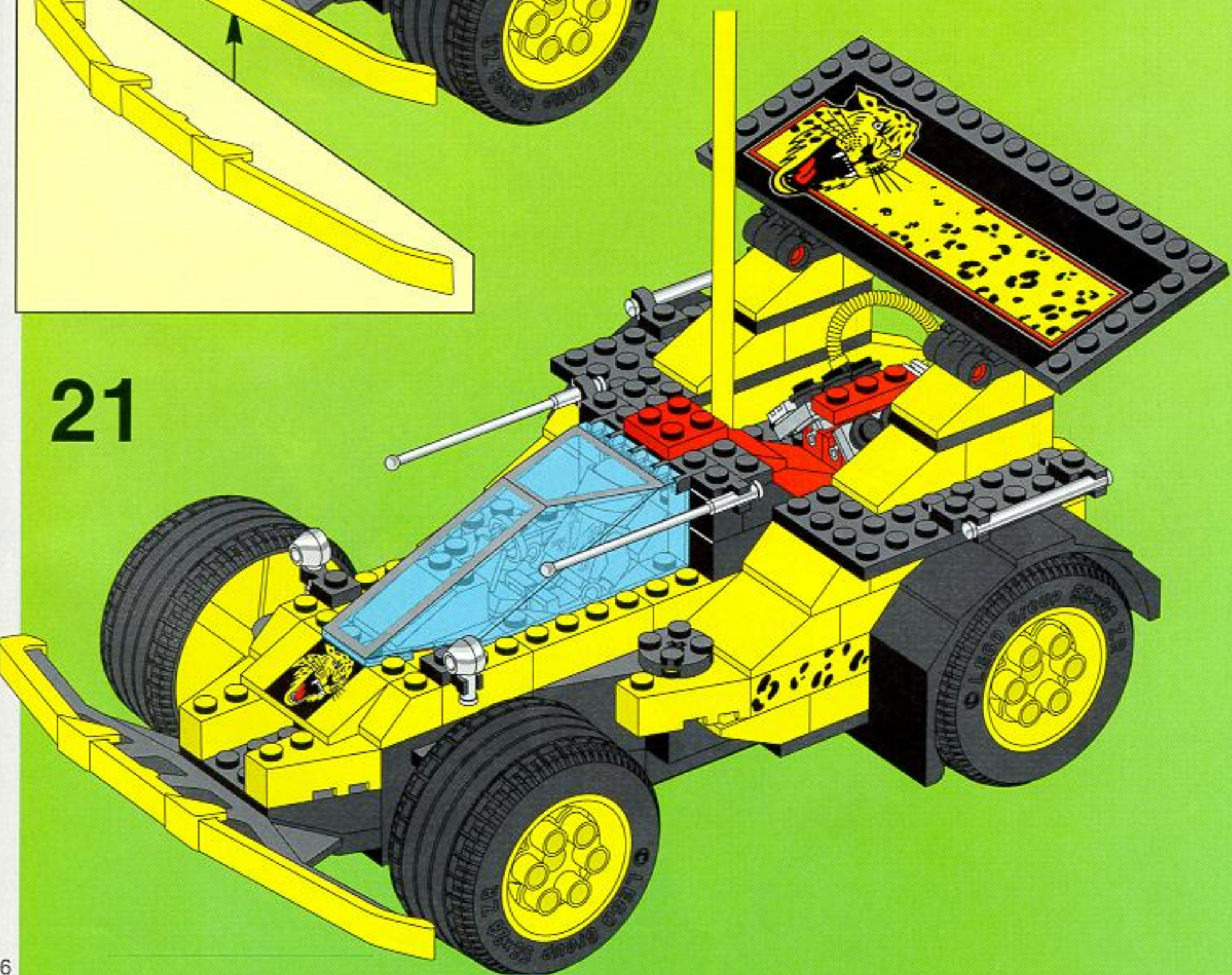

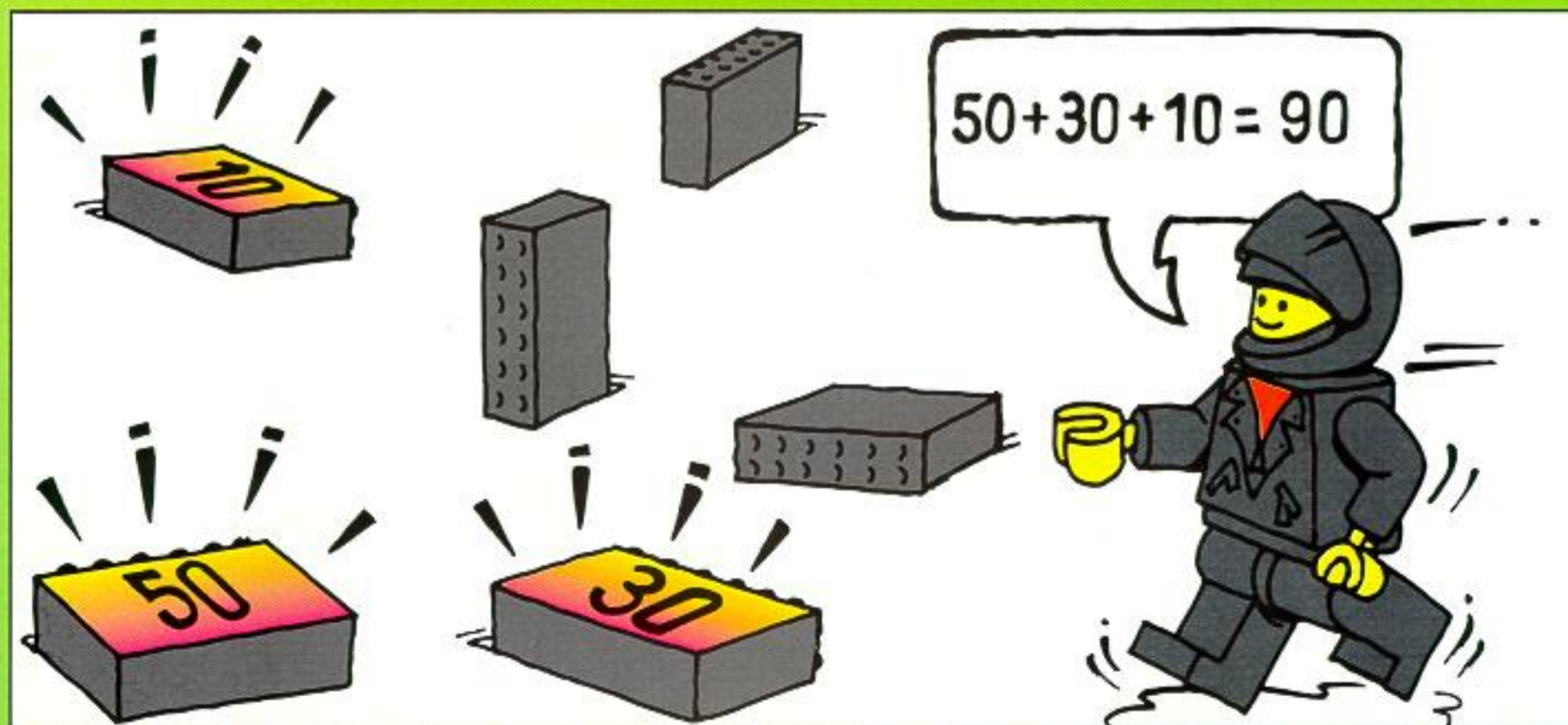
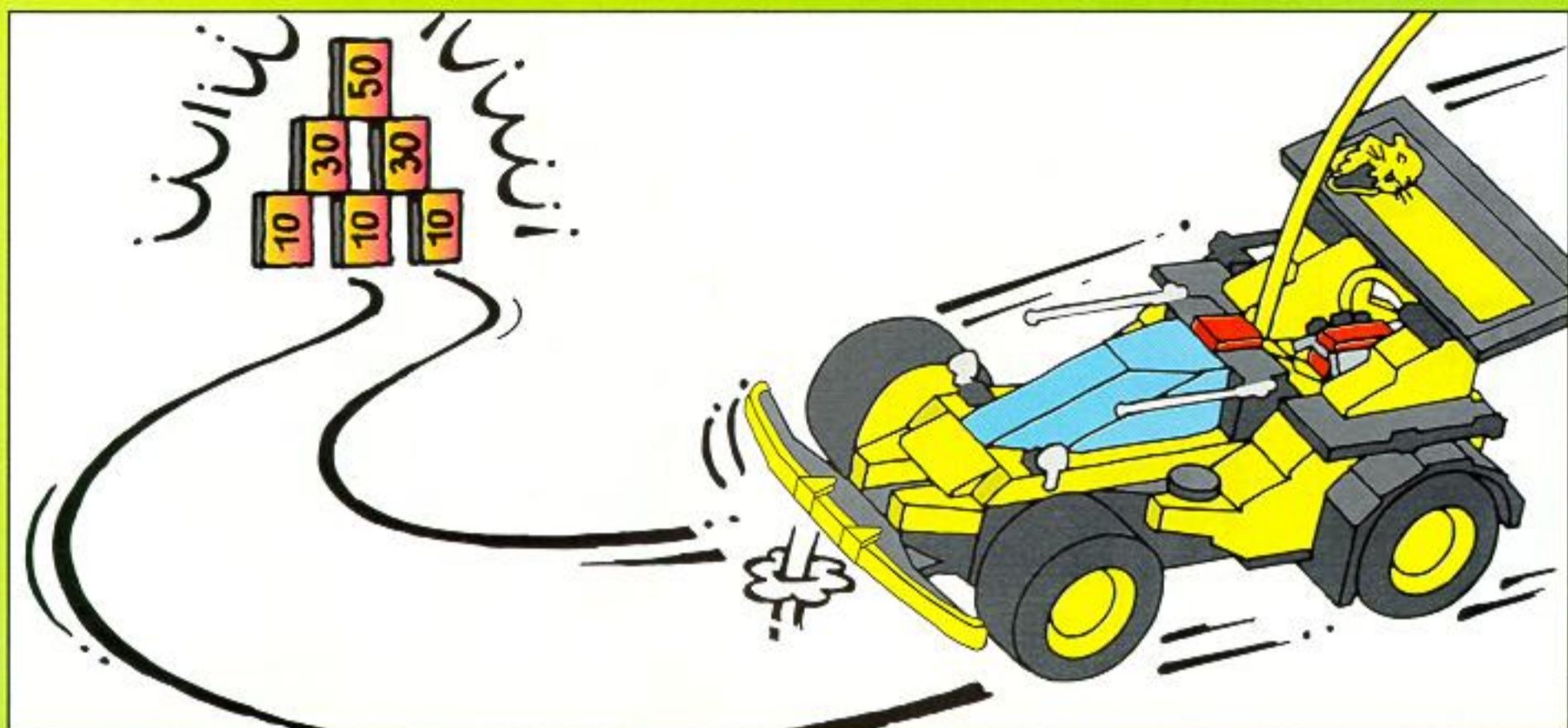

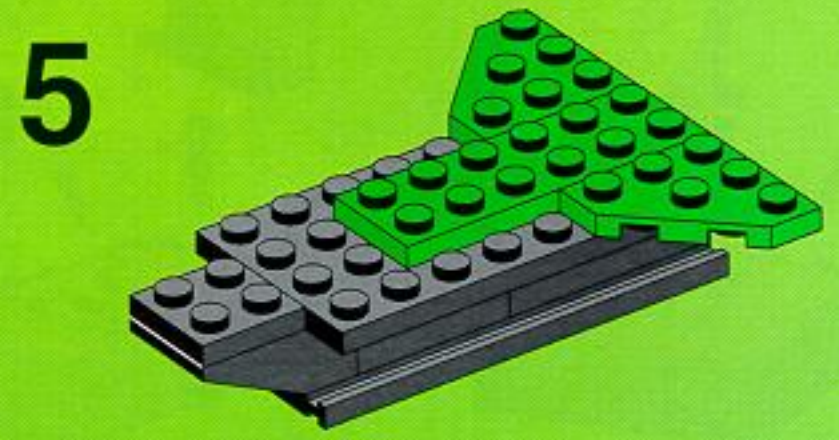
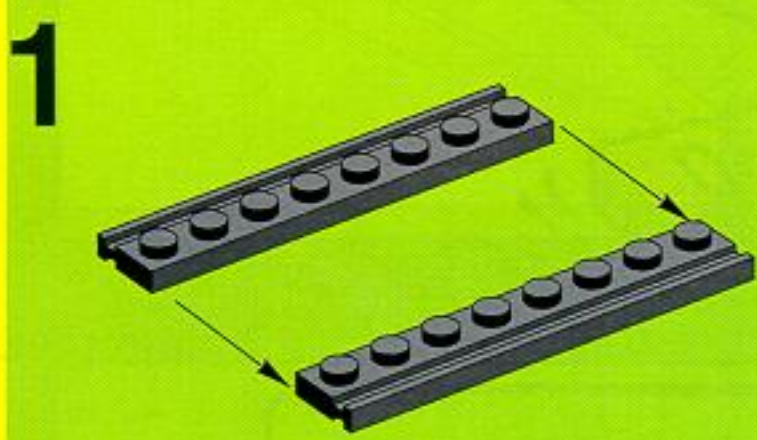
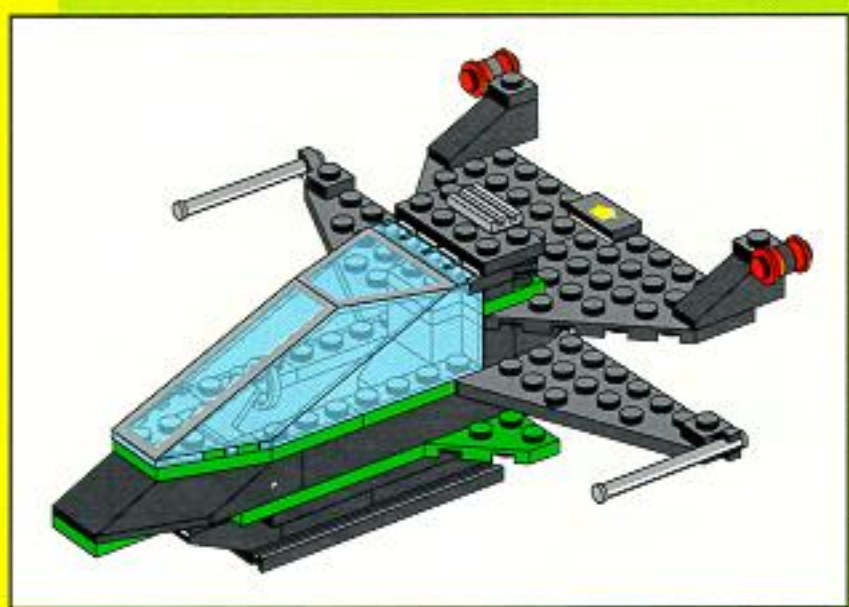

6

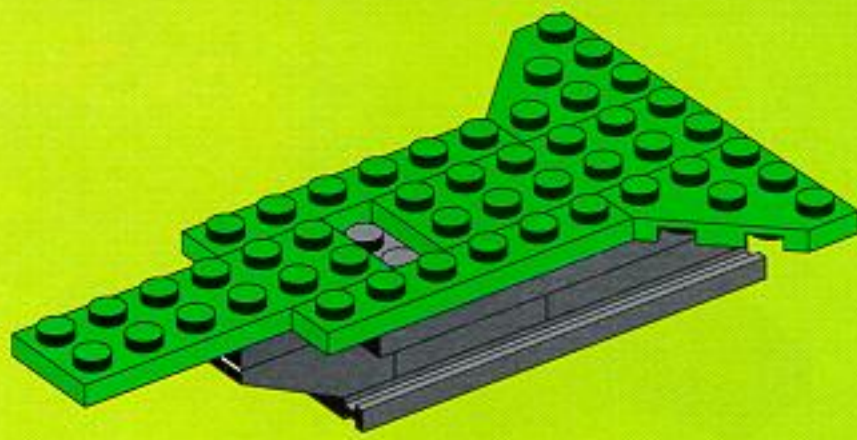

7

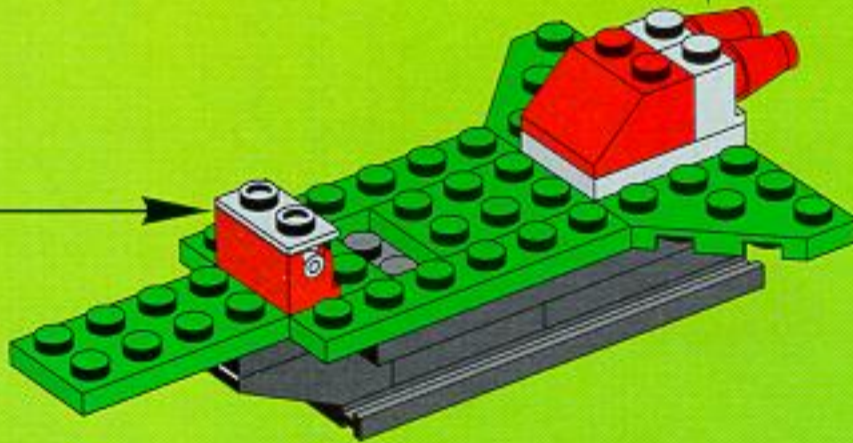
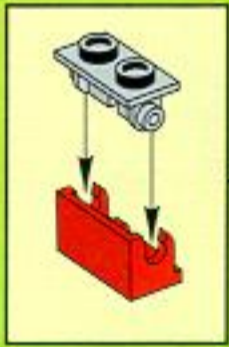
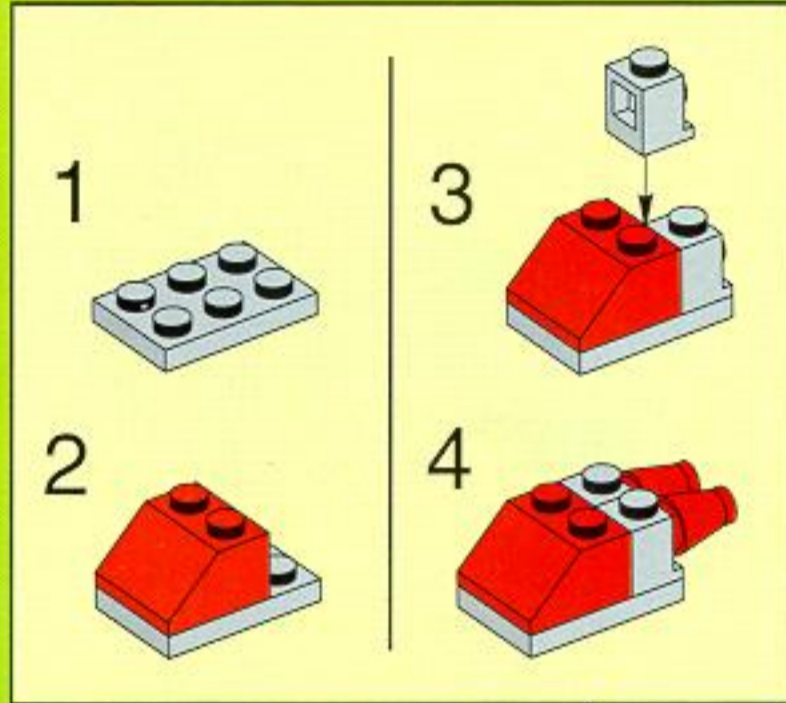

8

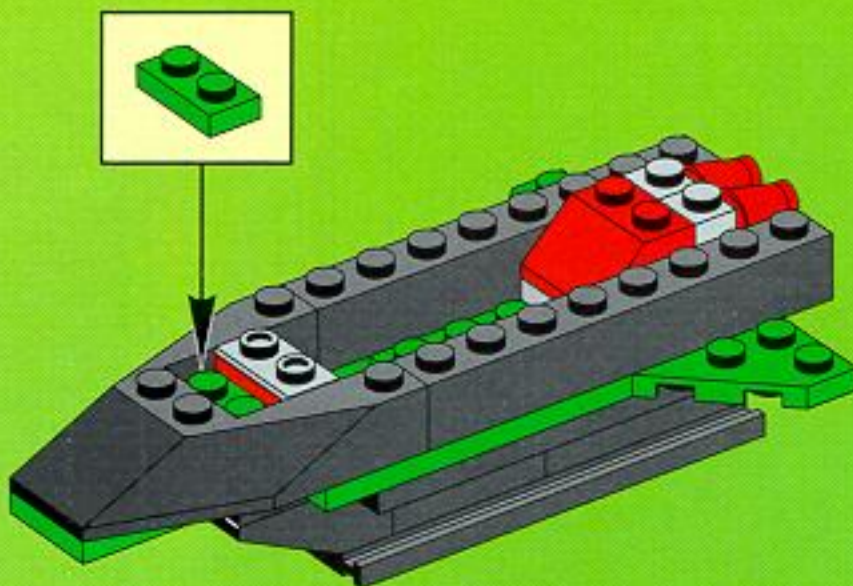

9

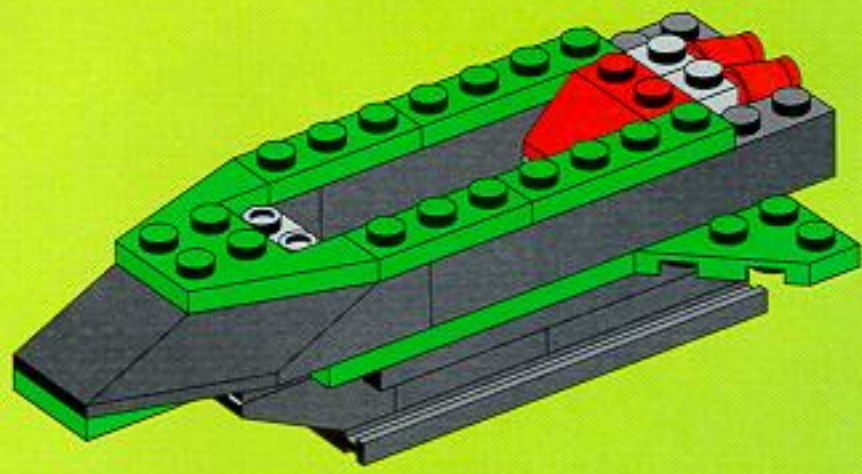

10

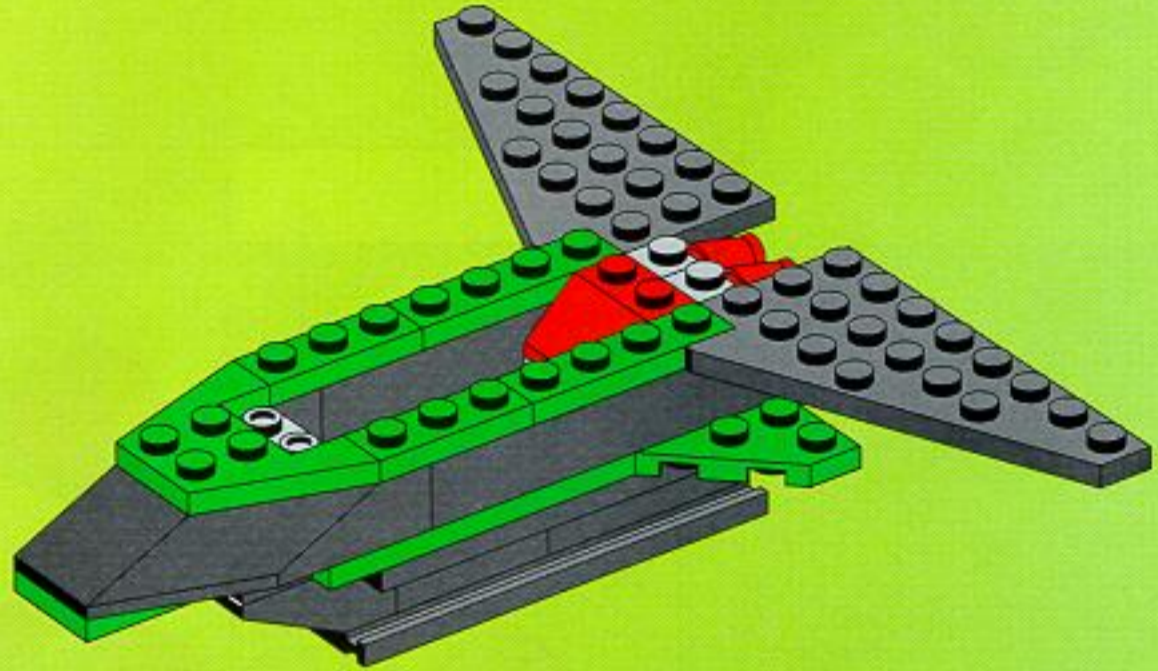

11

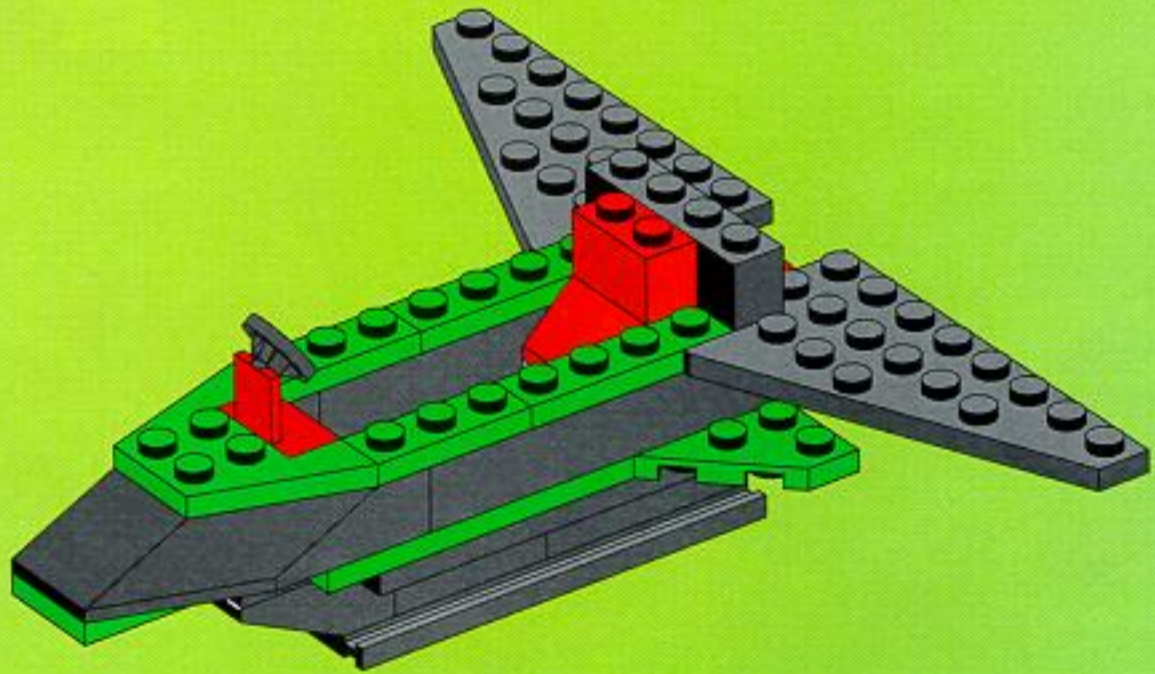

12

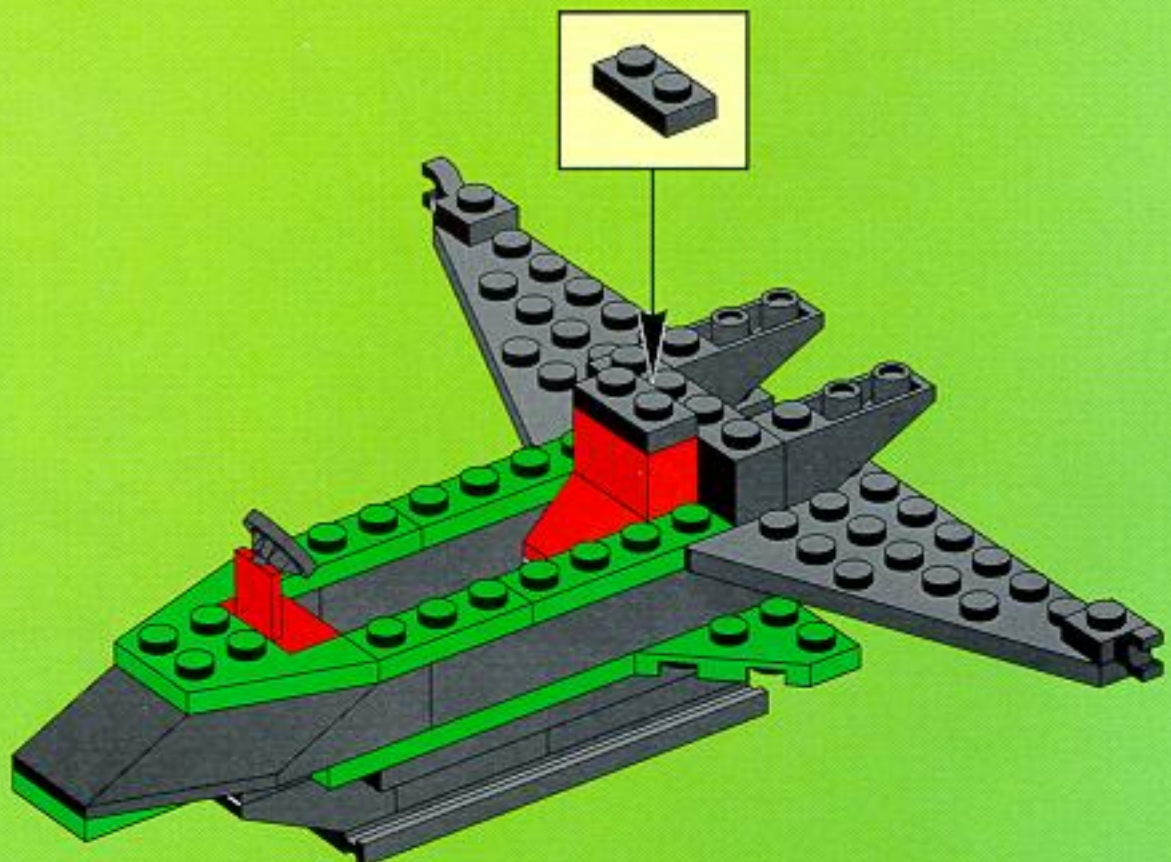

1



2



3

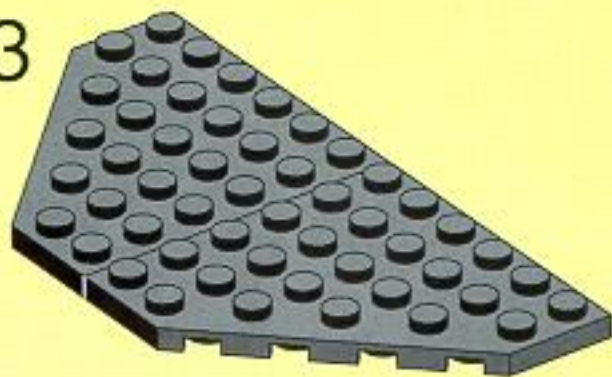

4

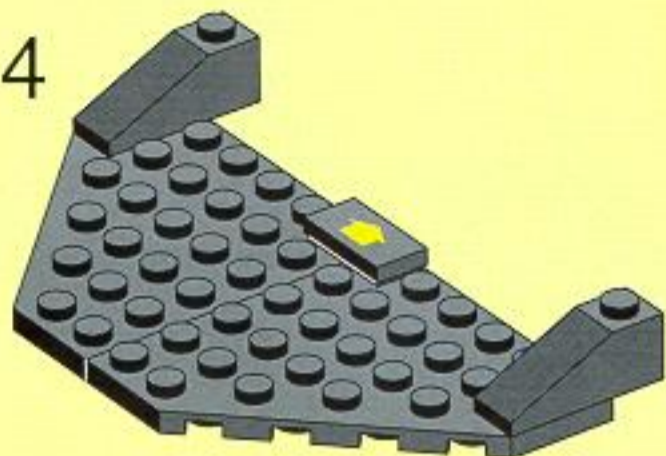

5

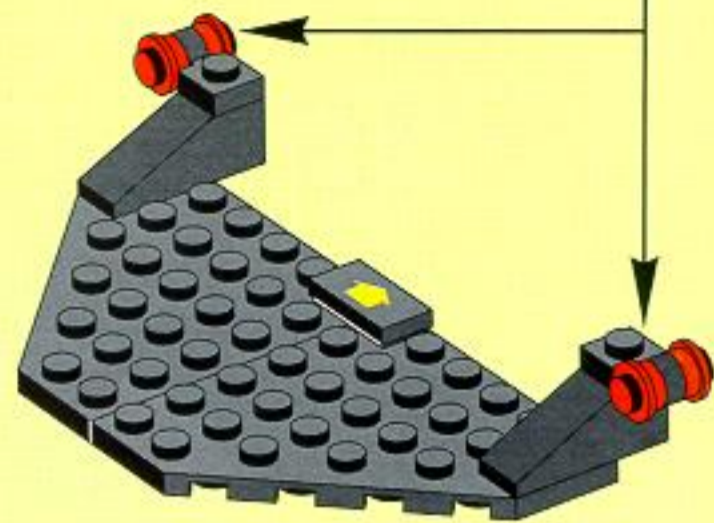
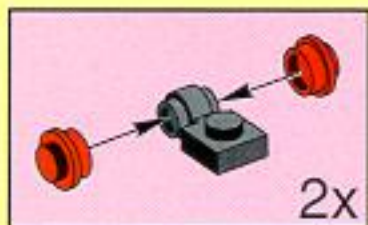

13

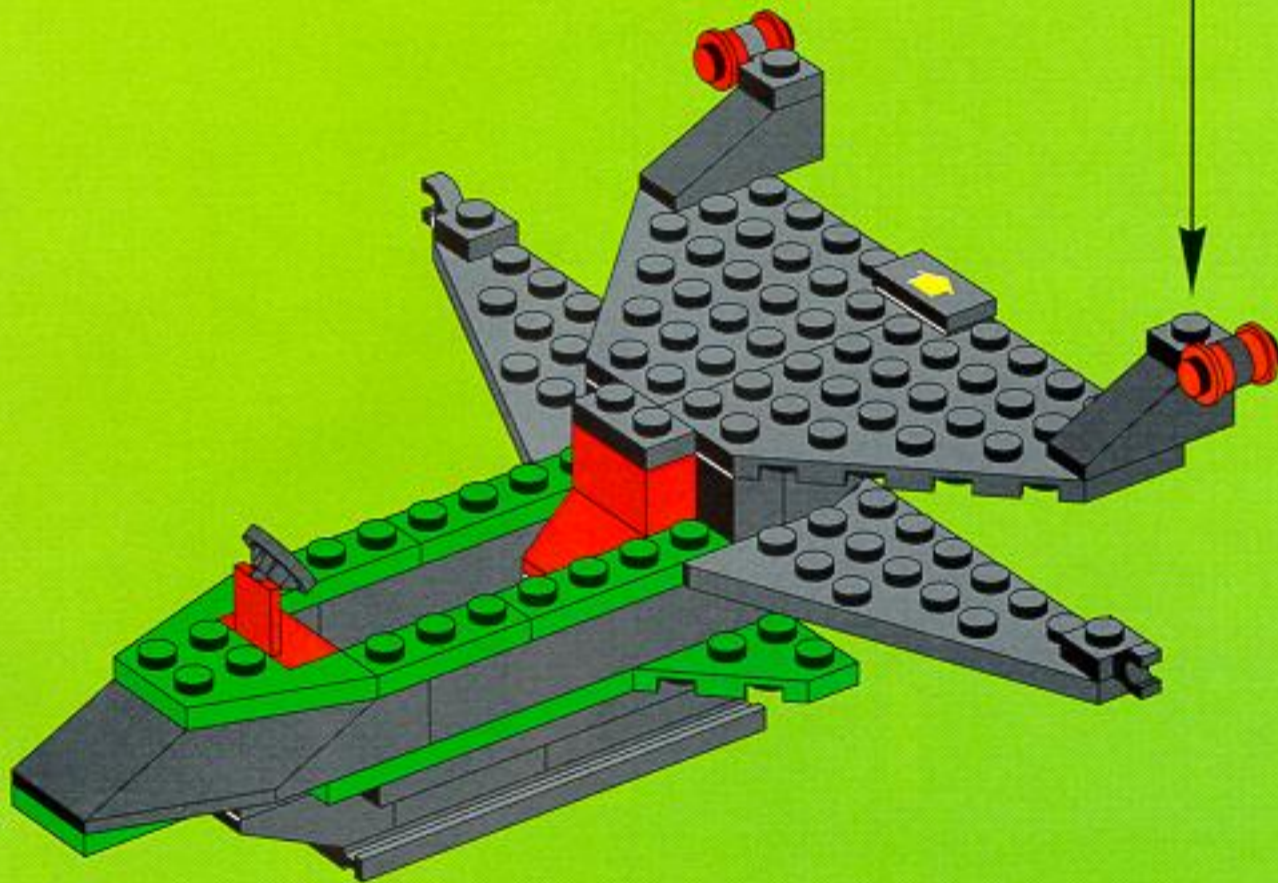

14

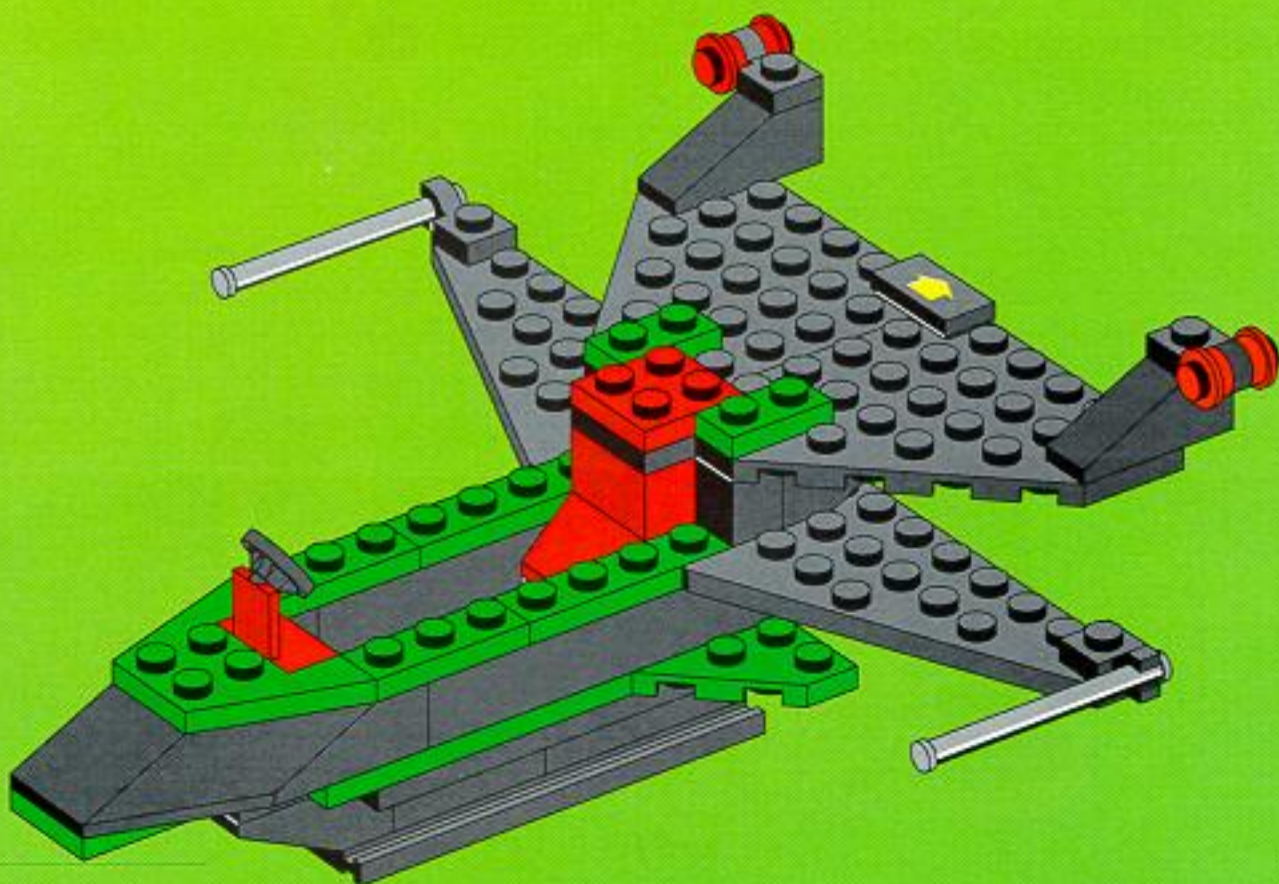

15

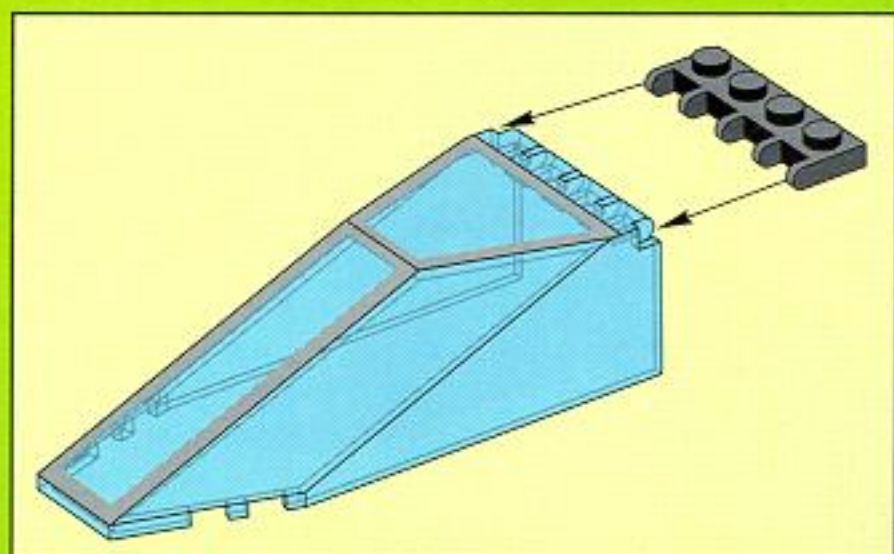
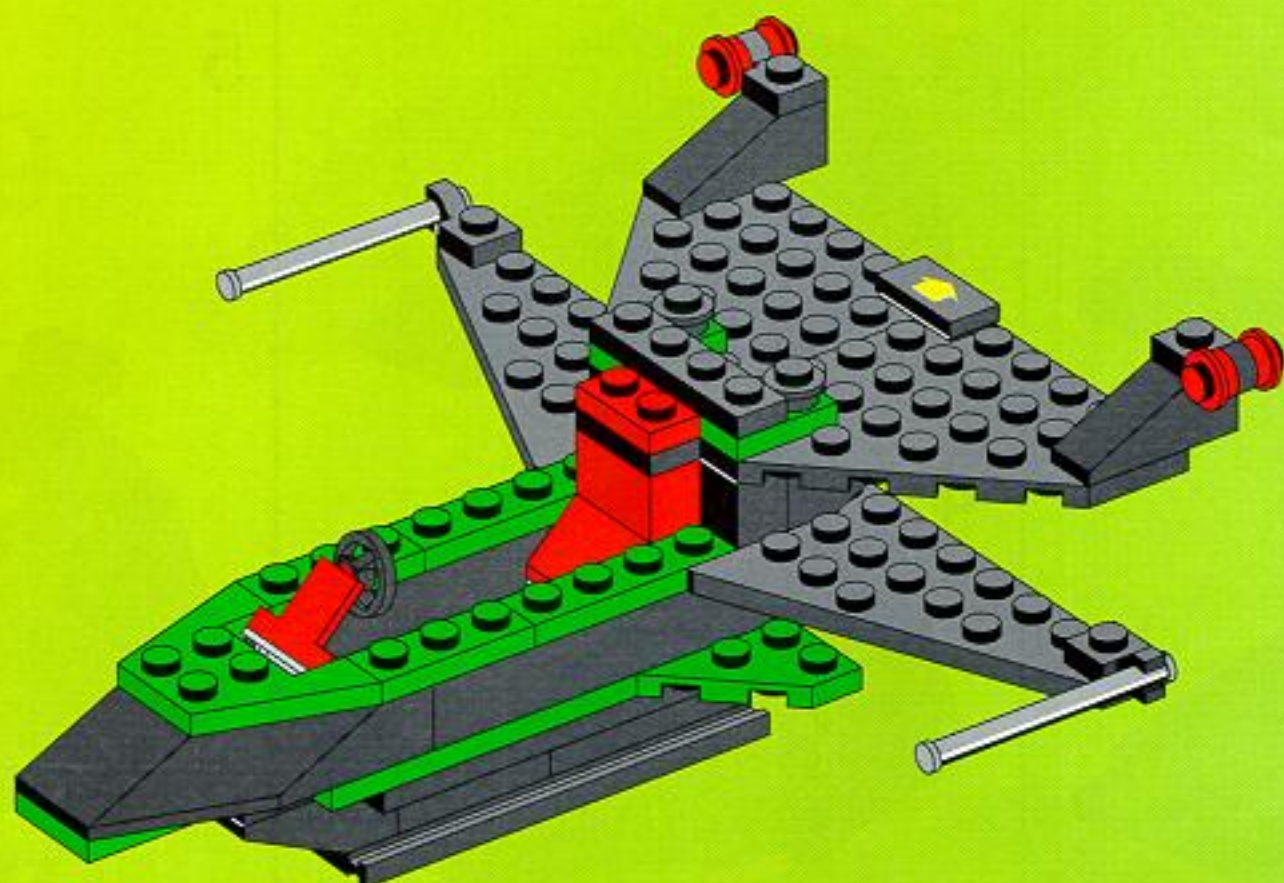

16

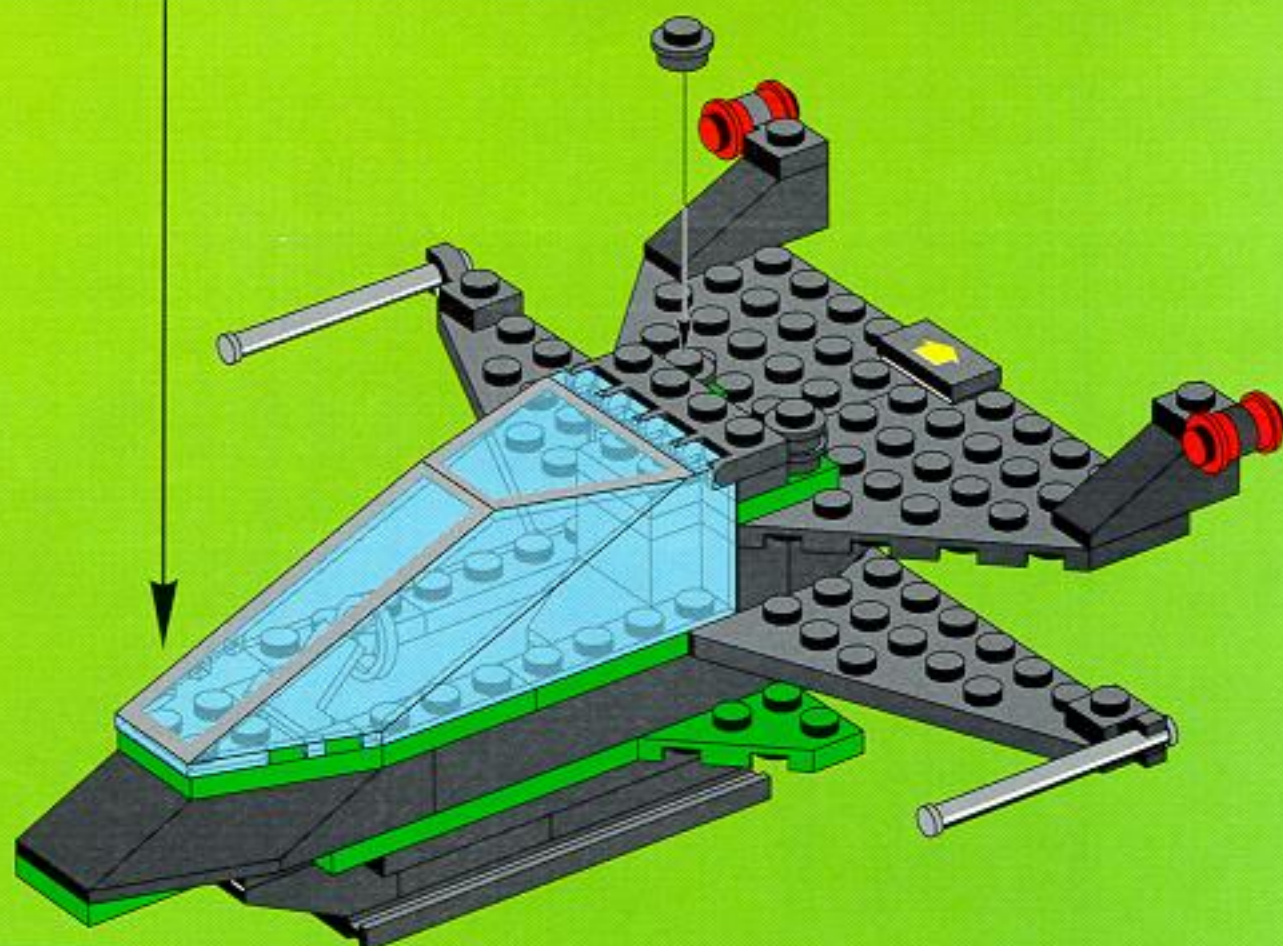

17

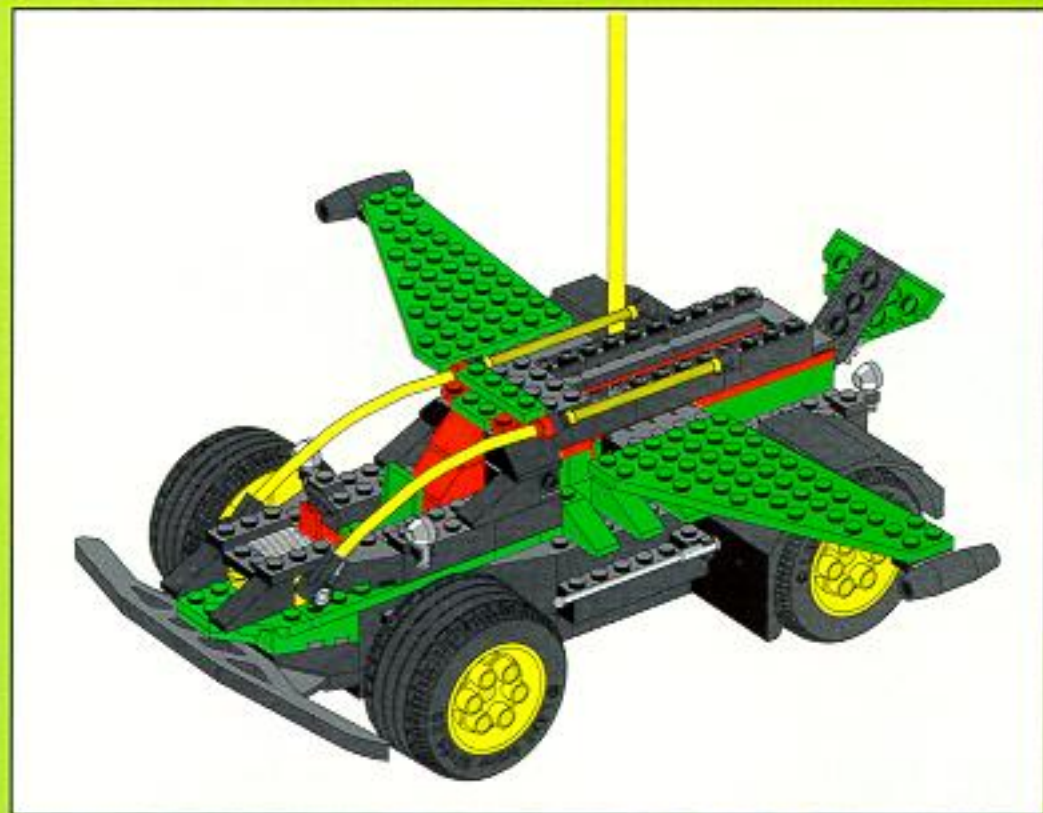
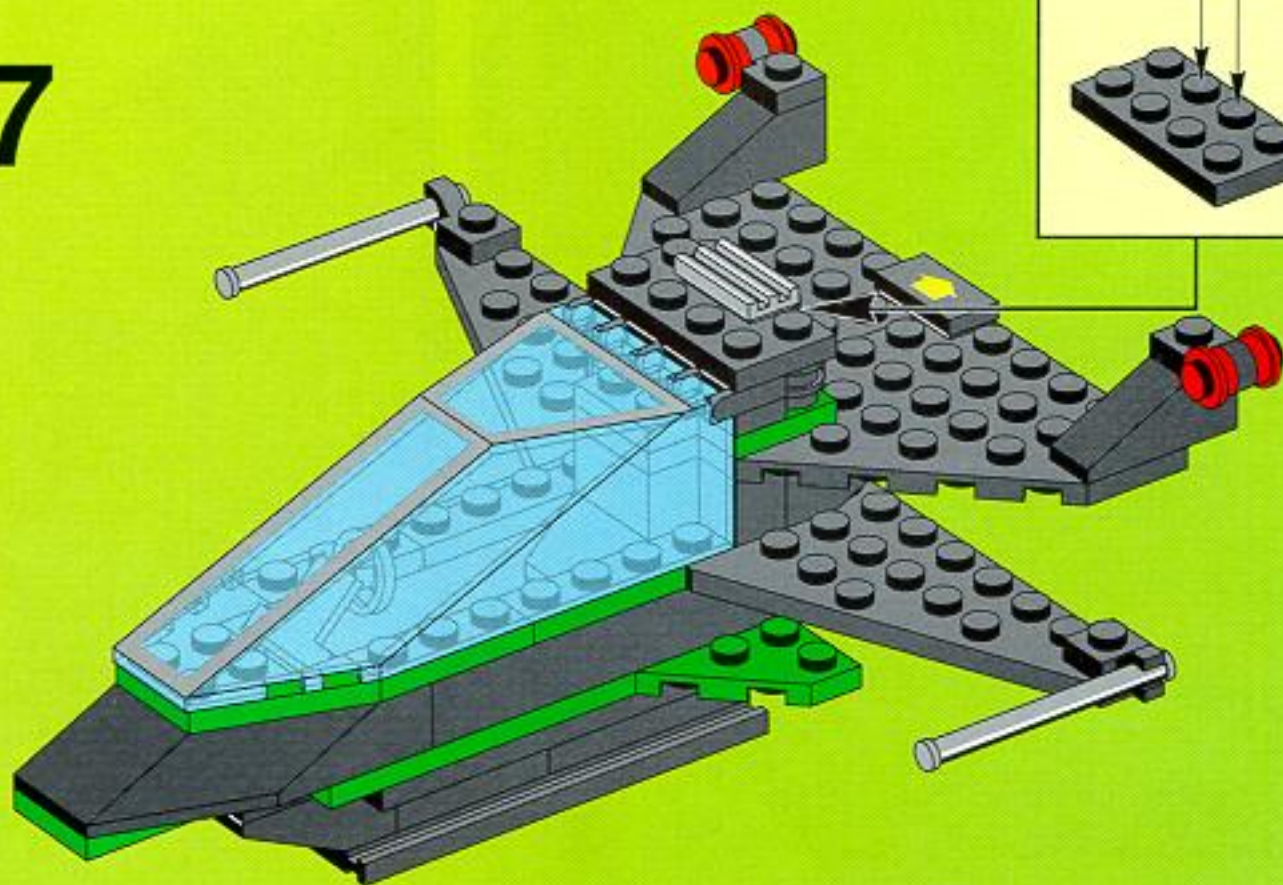

1

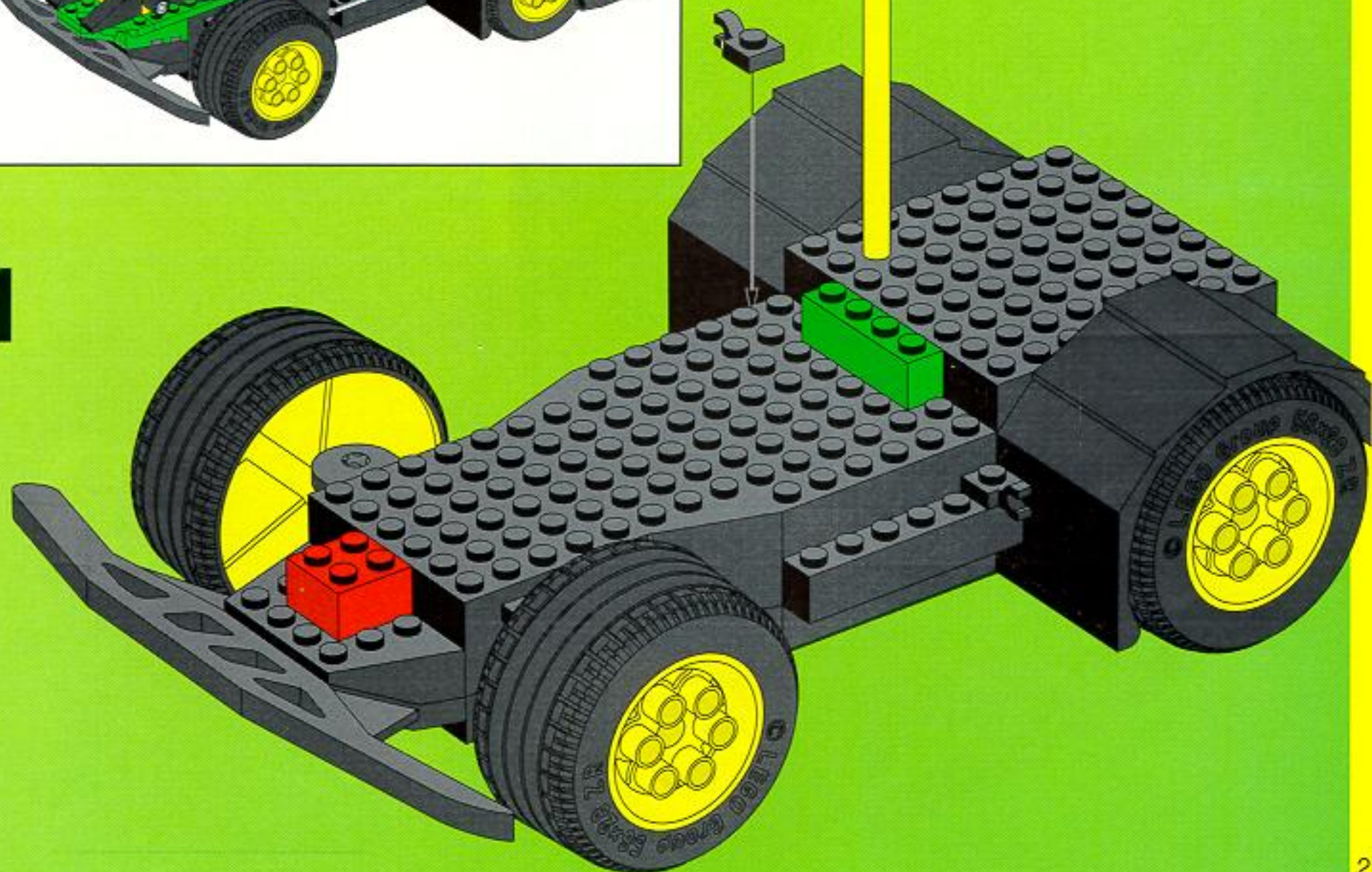

2

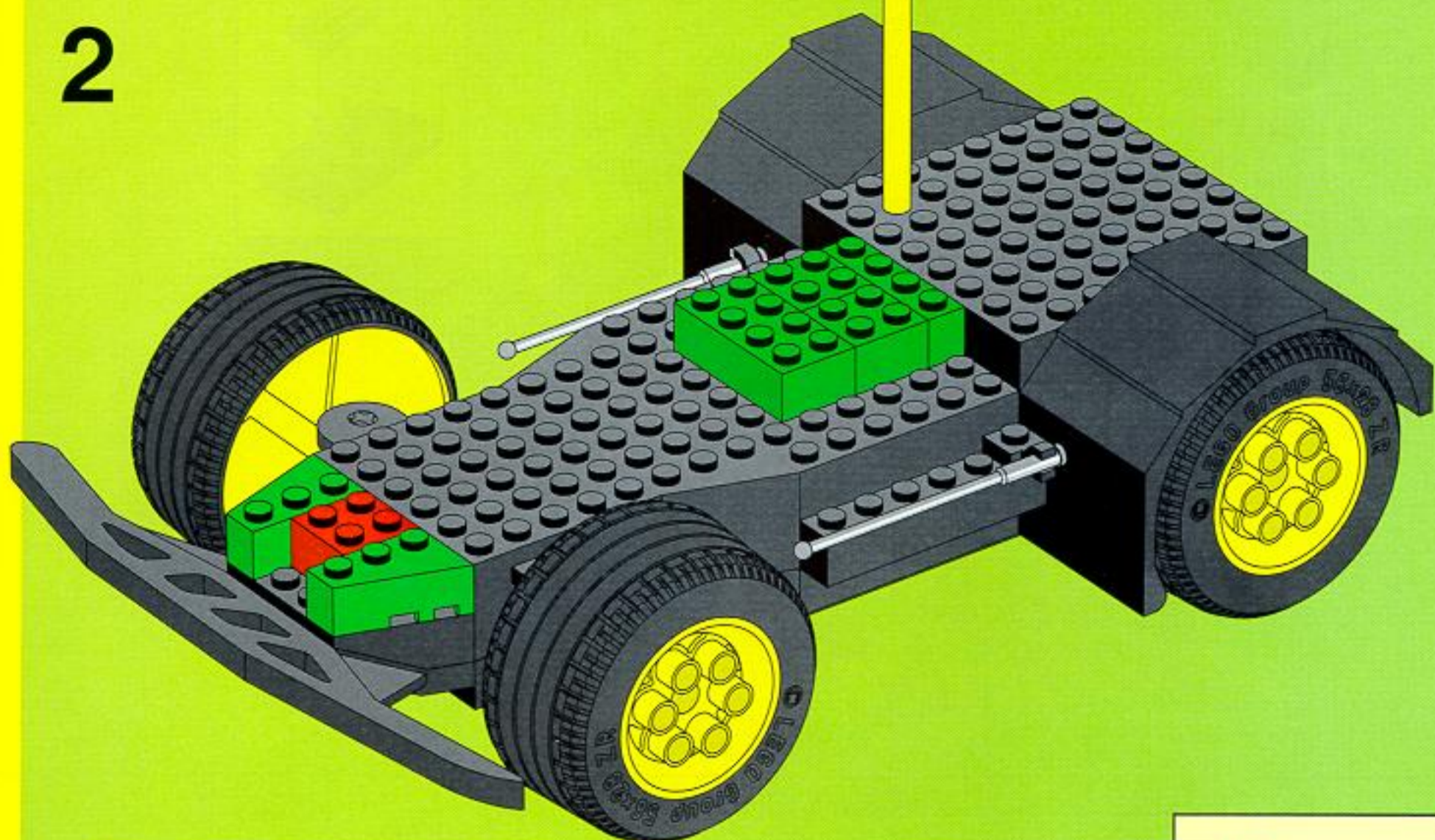

1



2



3

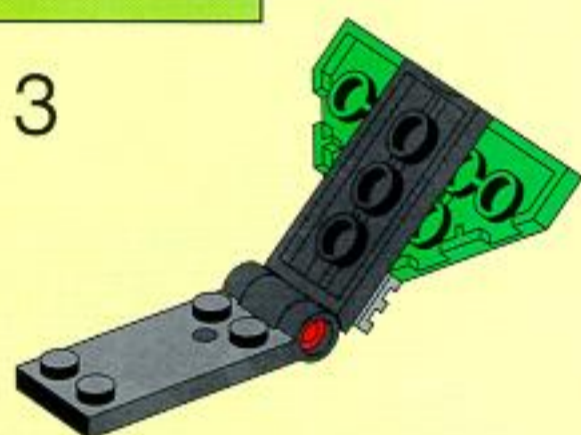

3

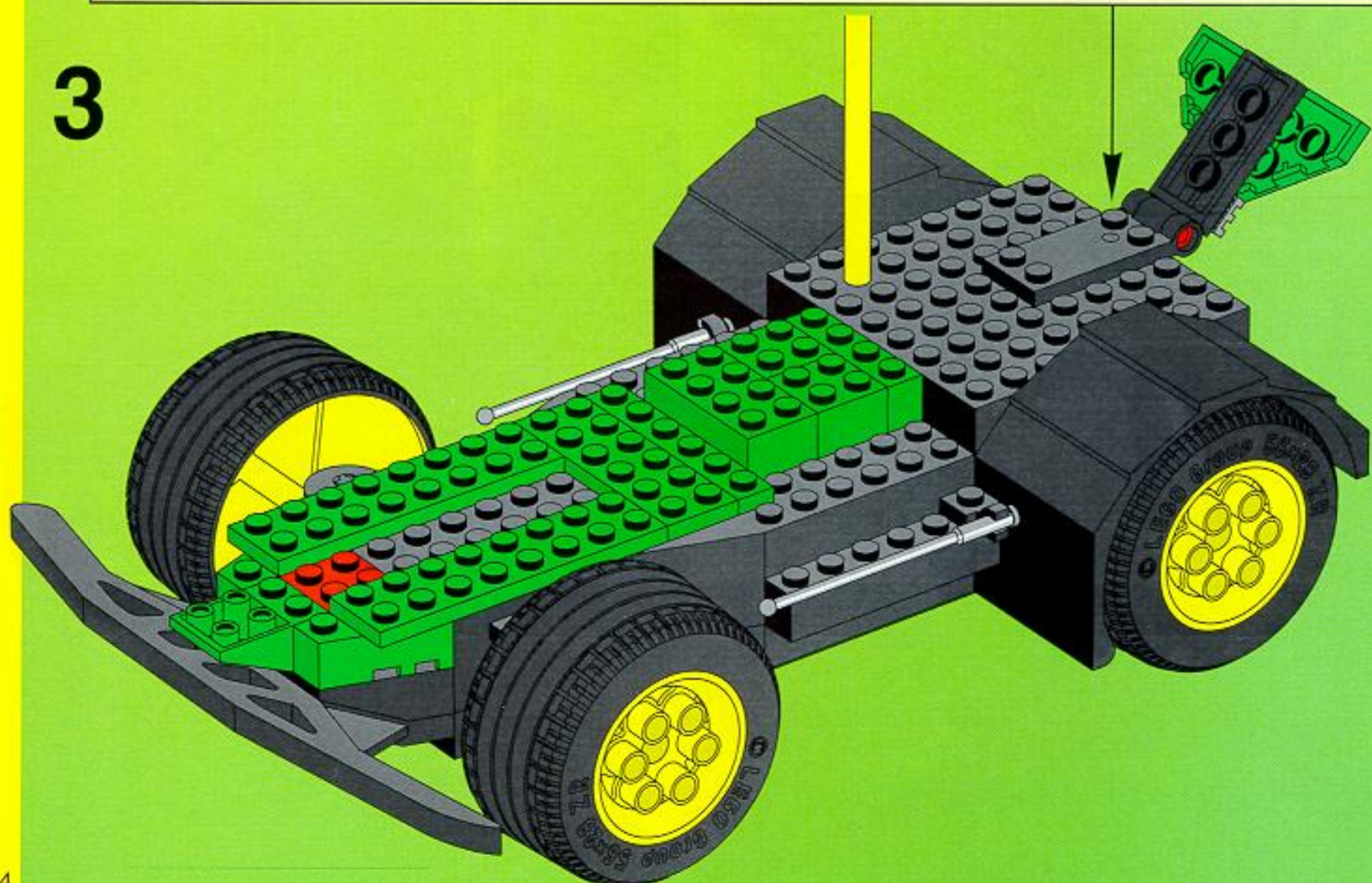

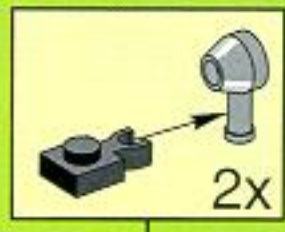
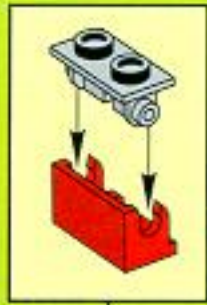

4

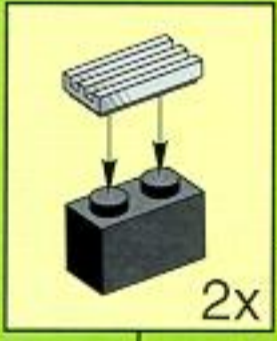
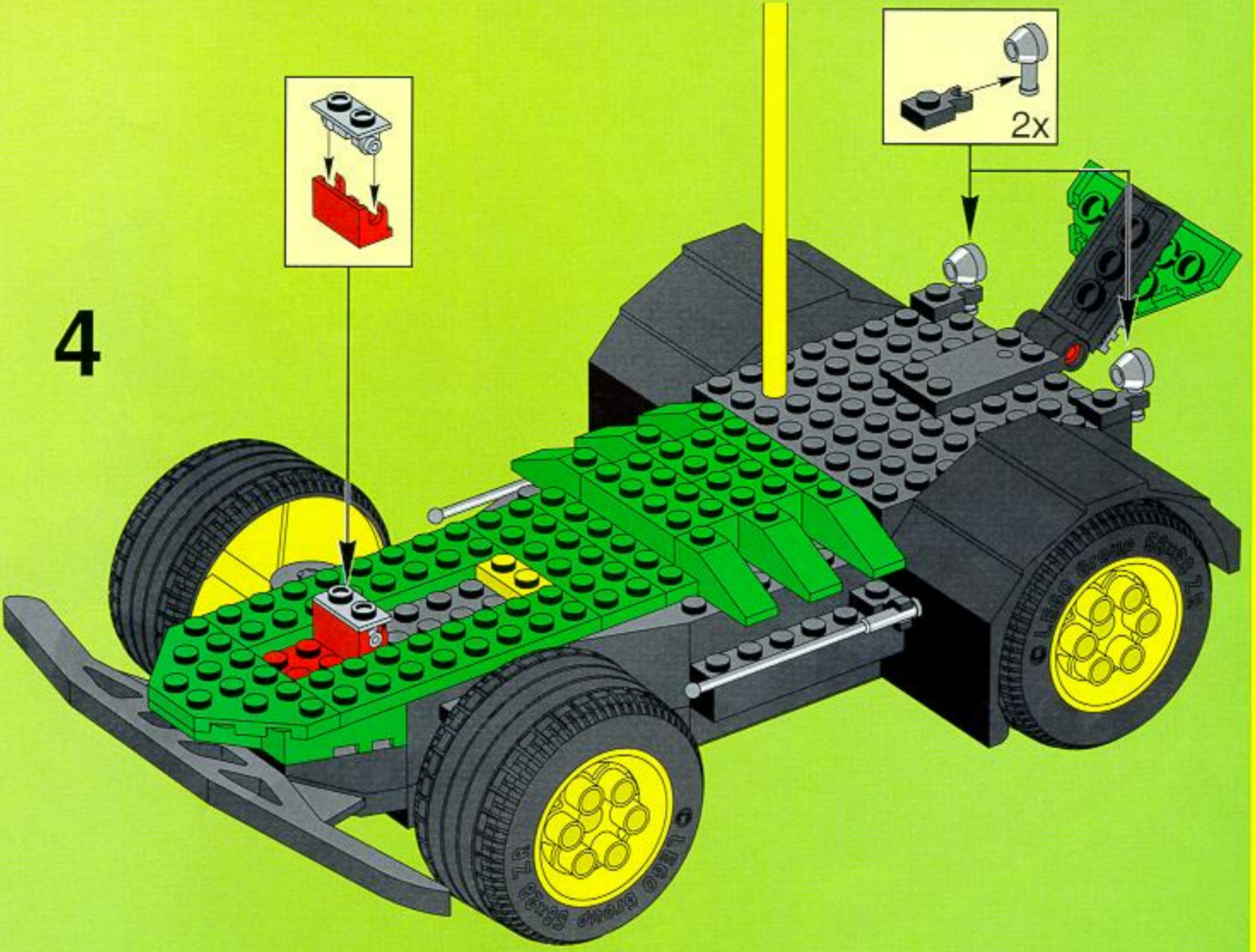

5

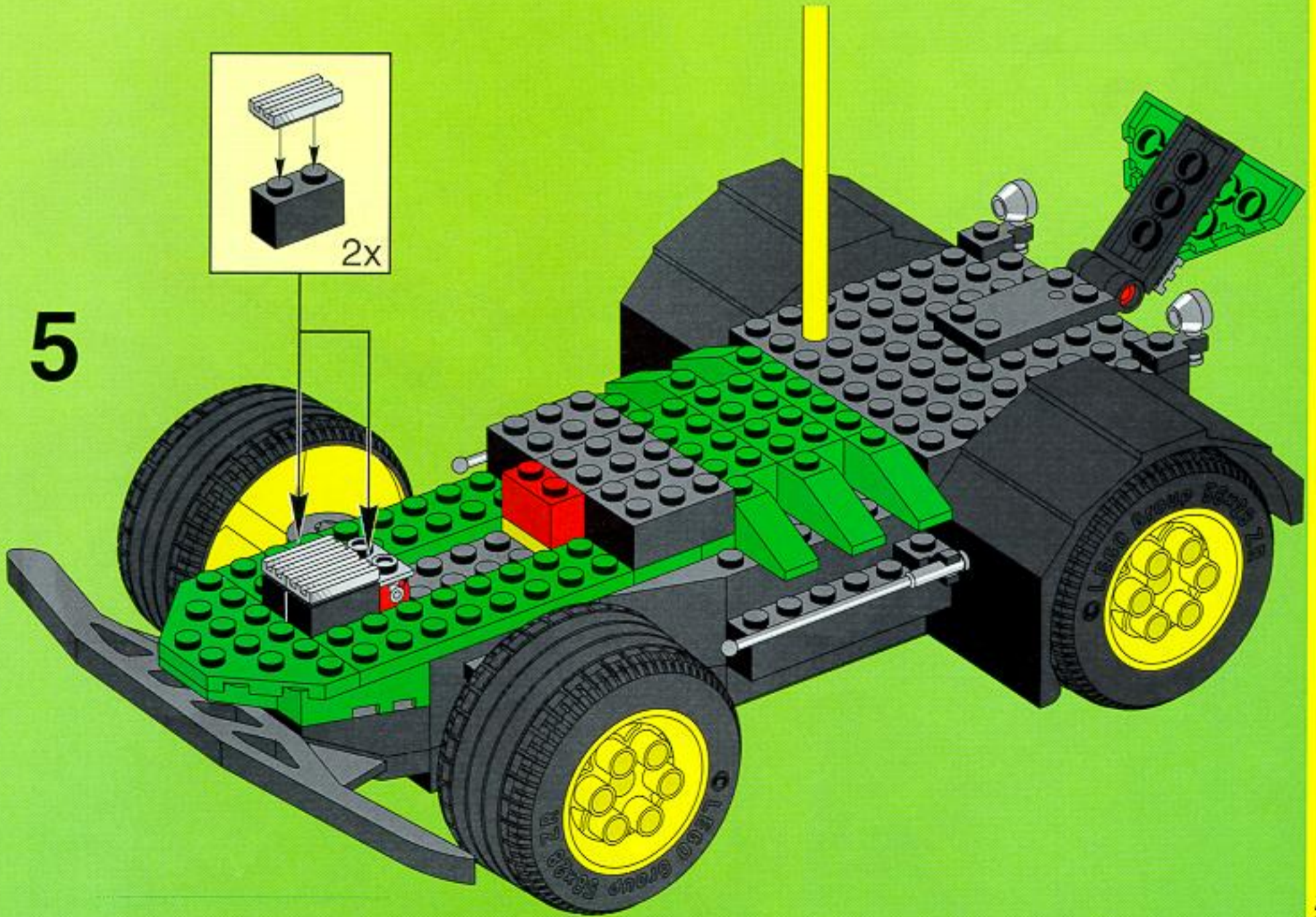

6

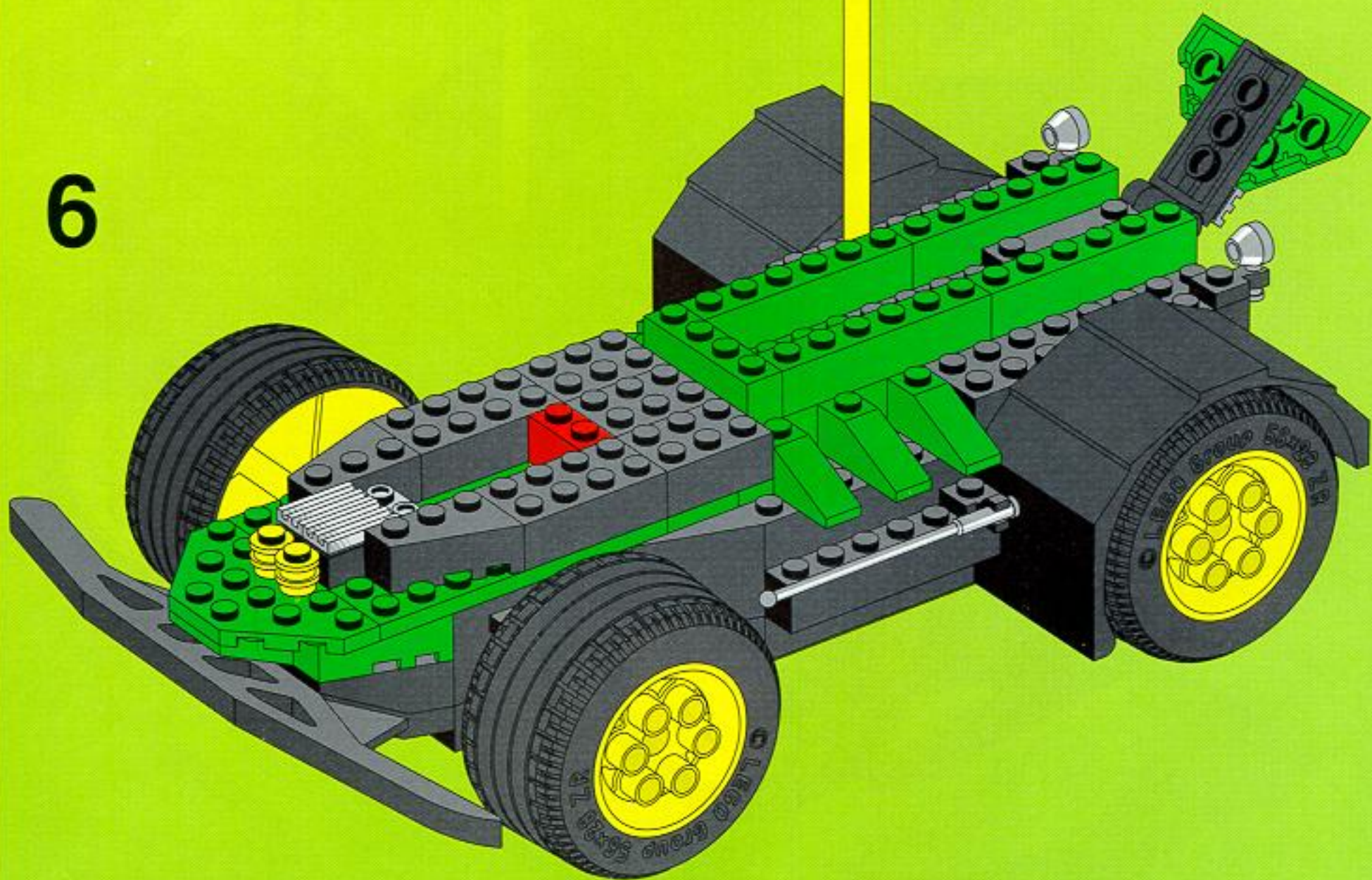

7

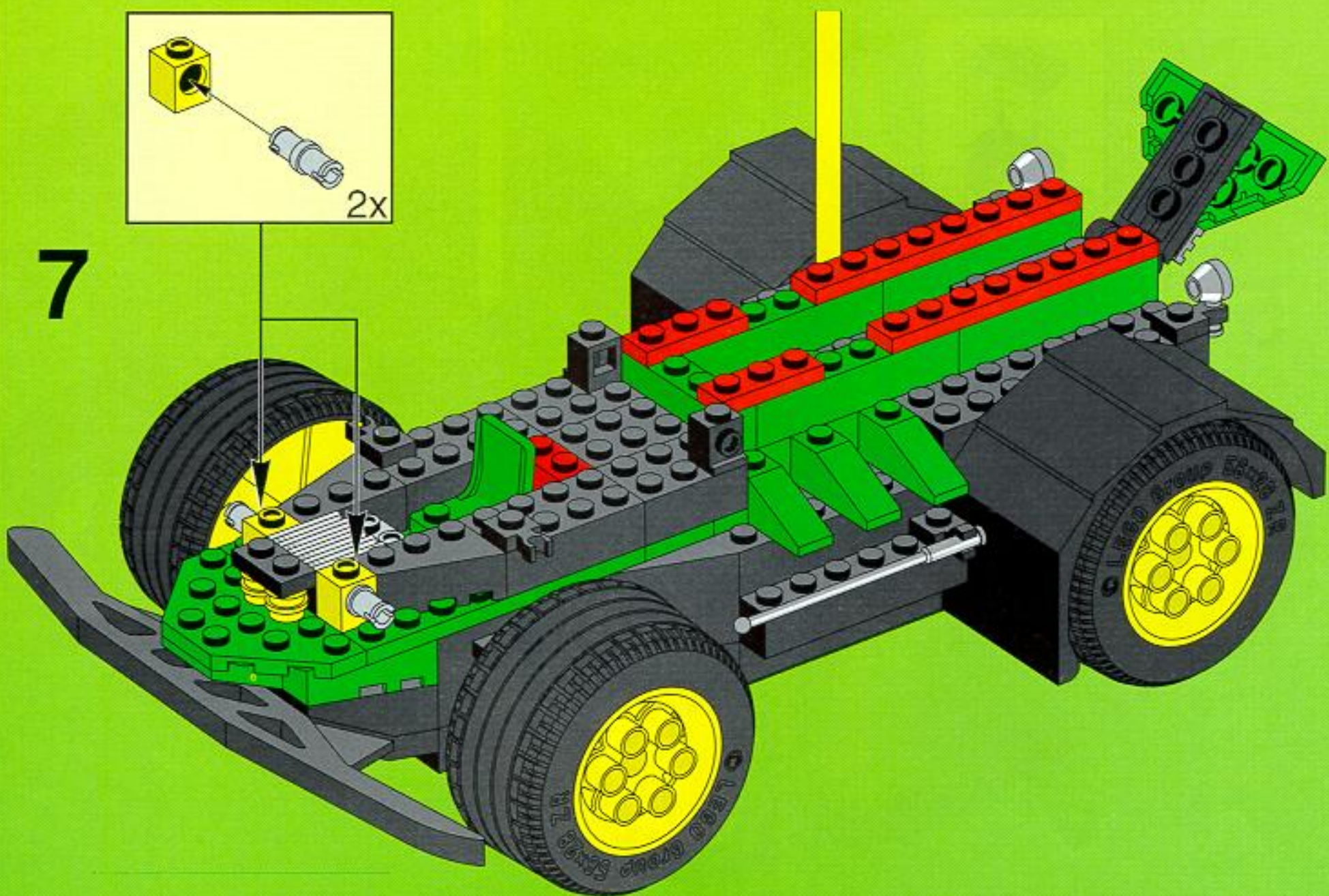

8

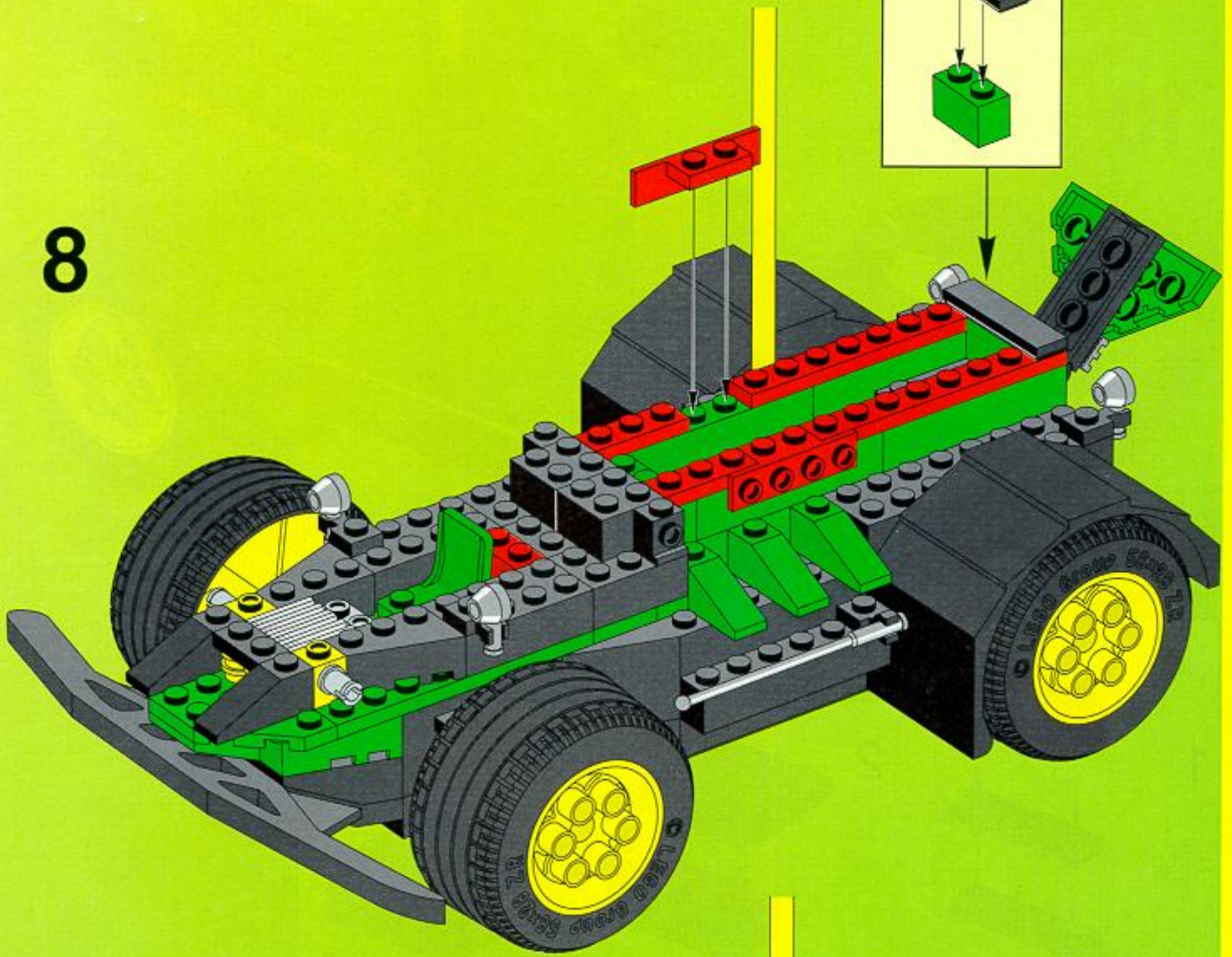

9

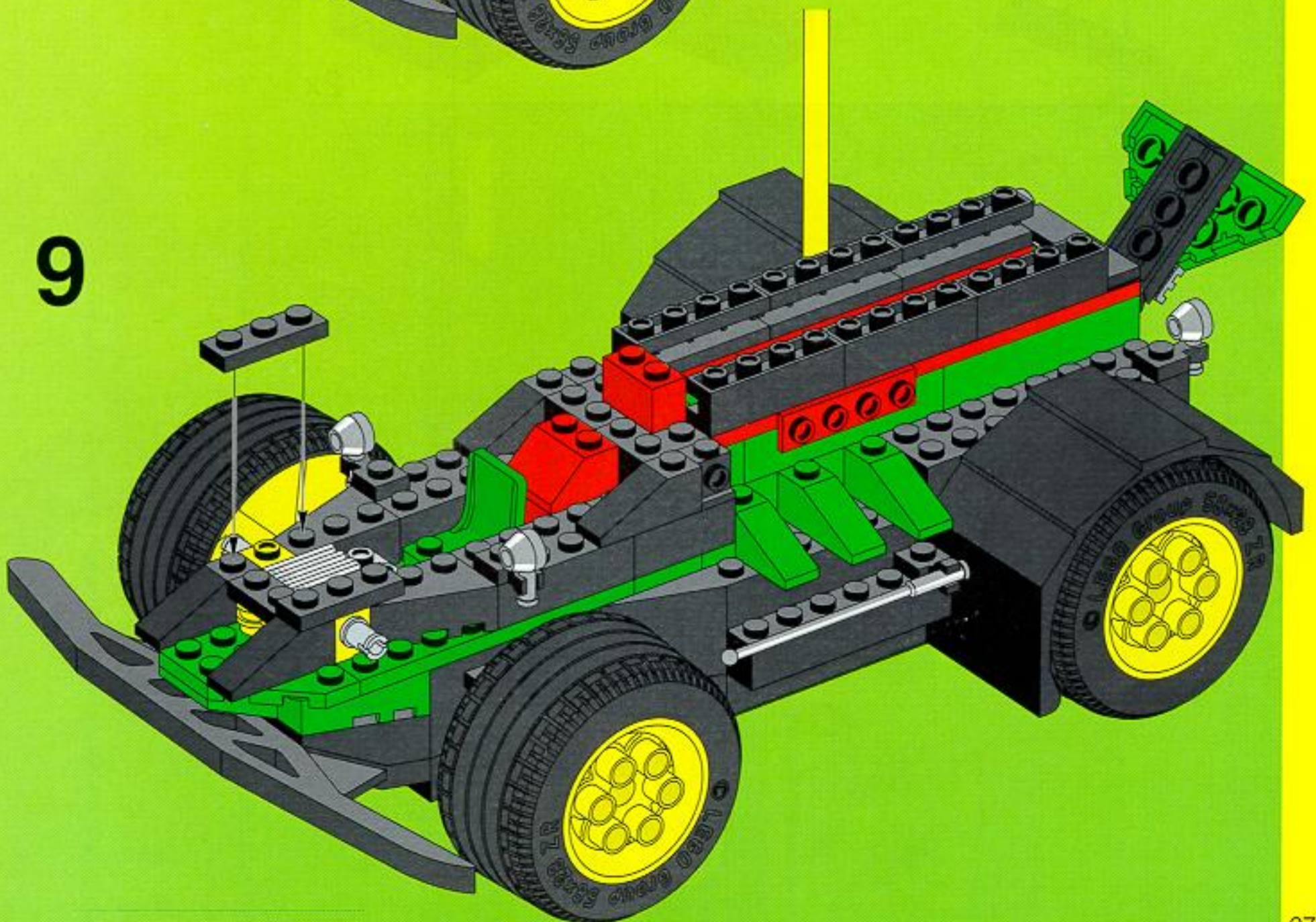

10

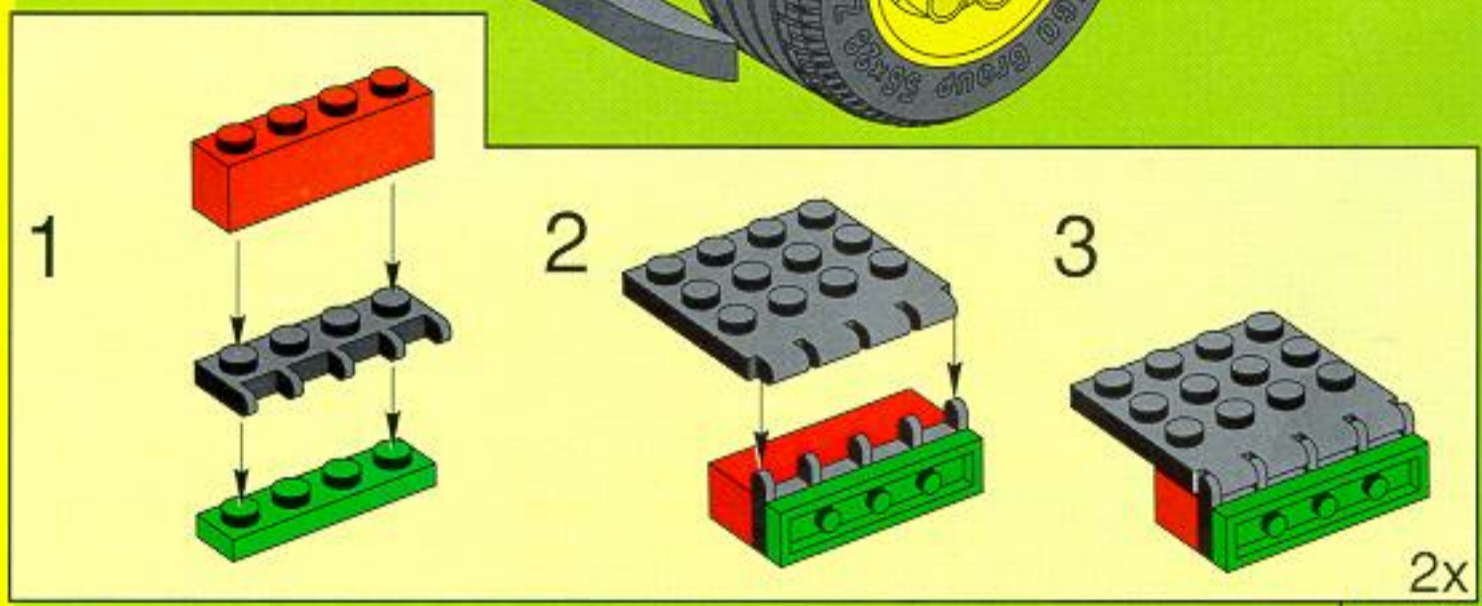
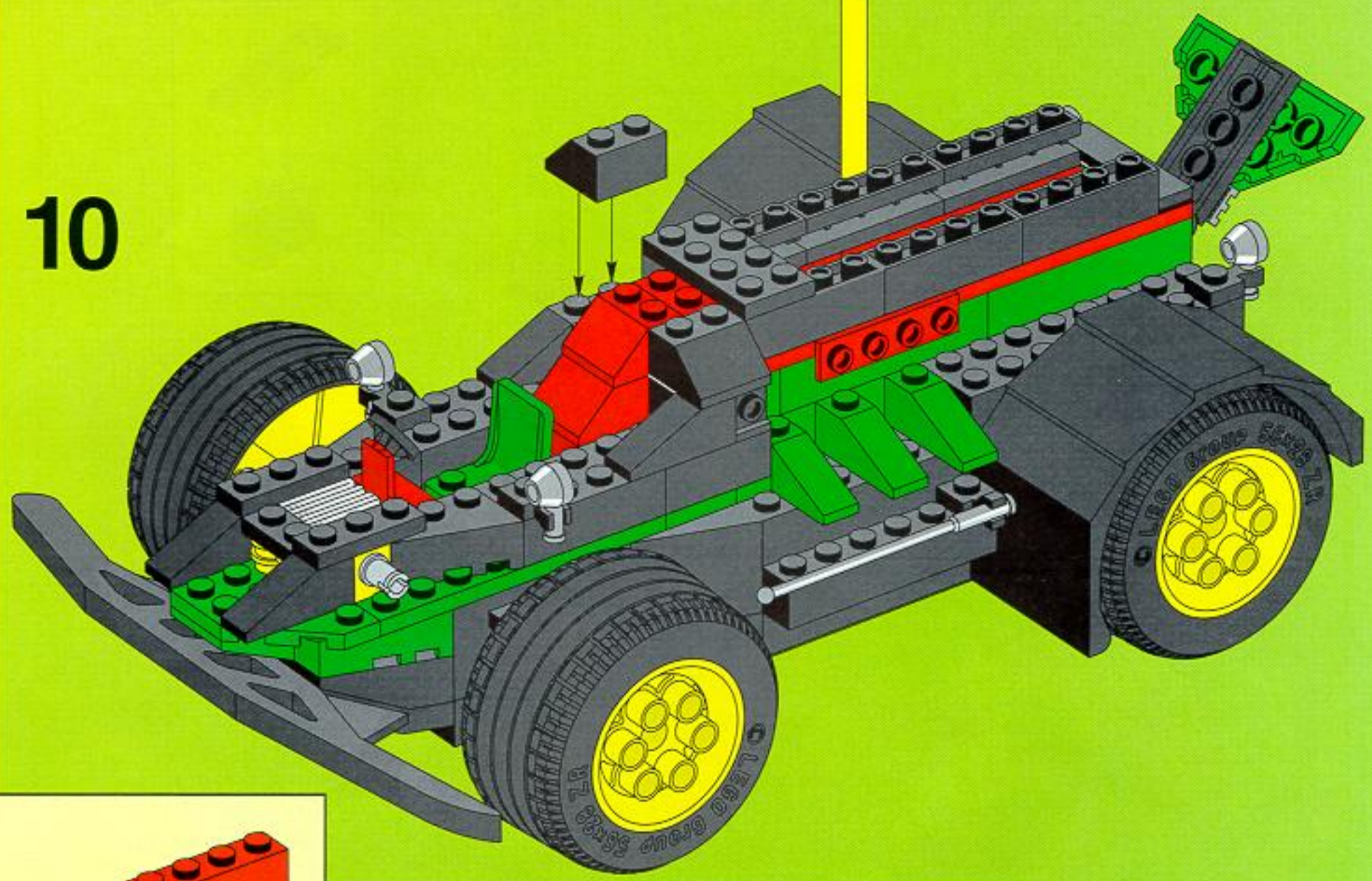

11

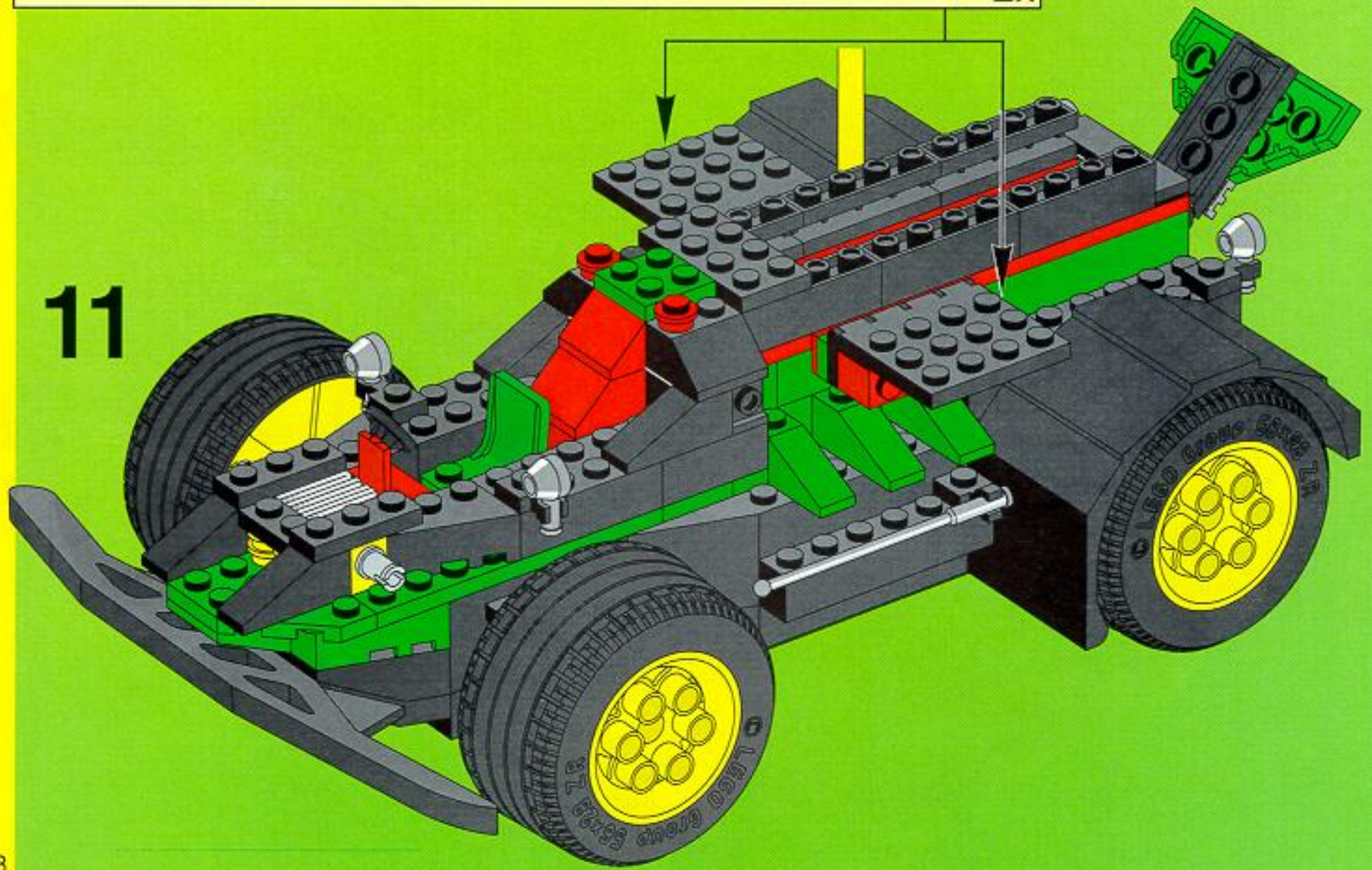

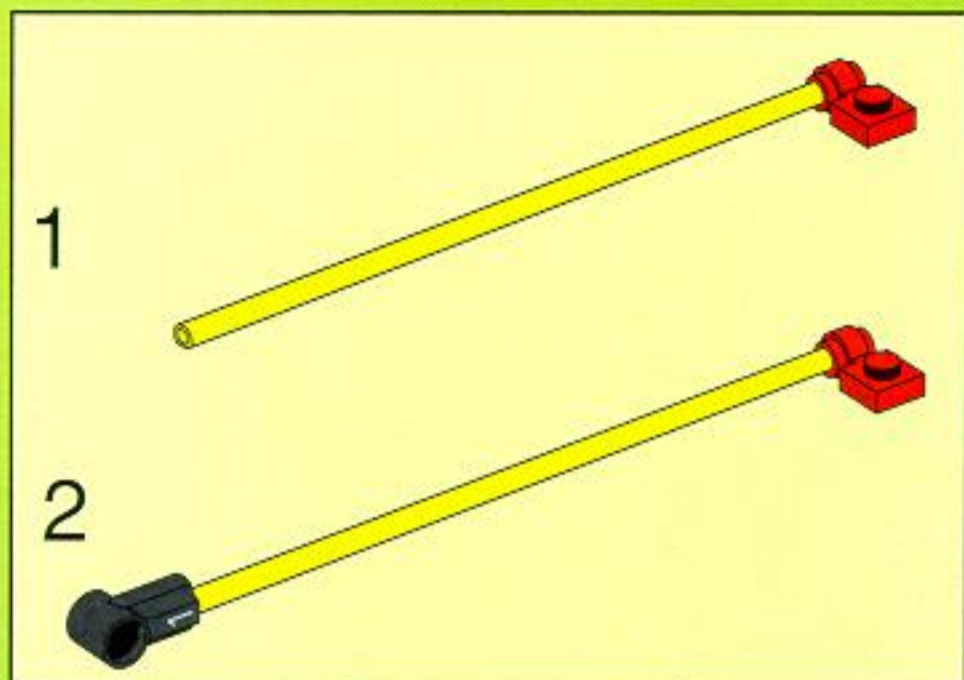

12

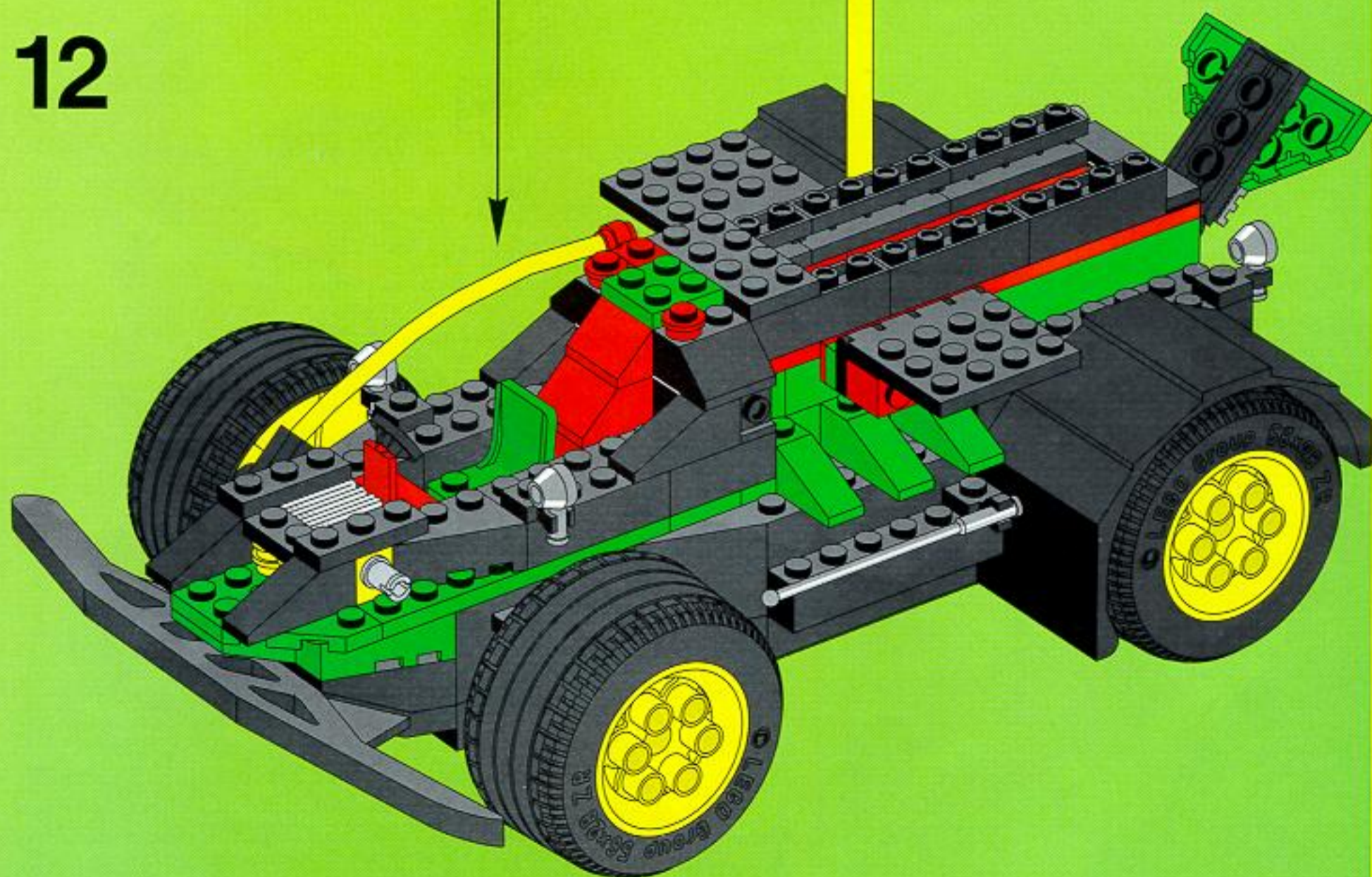

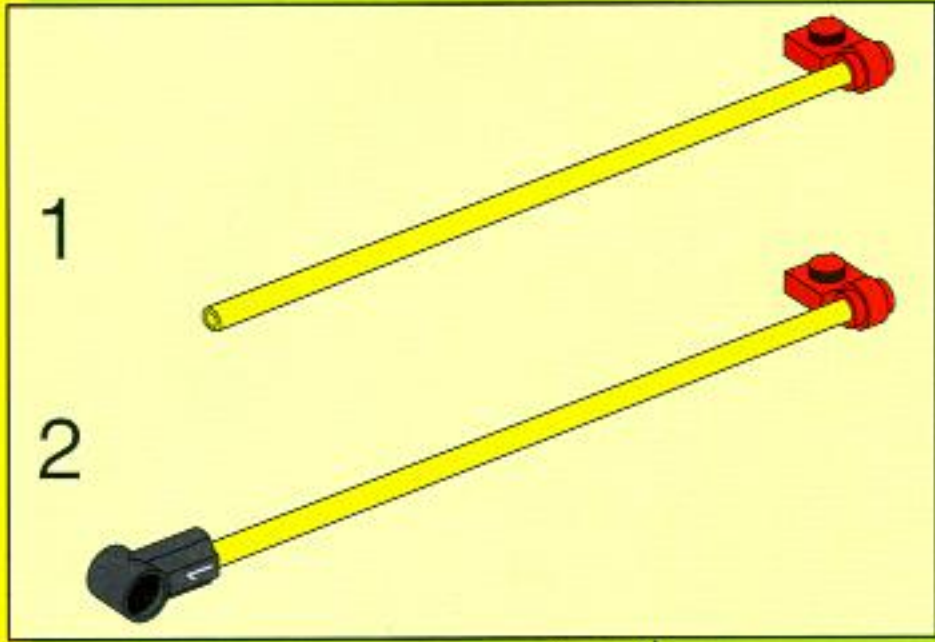

13

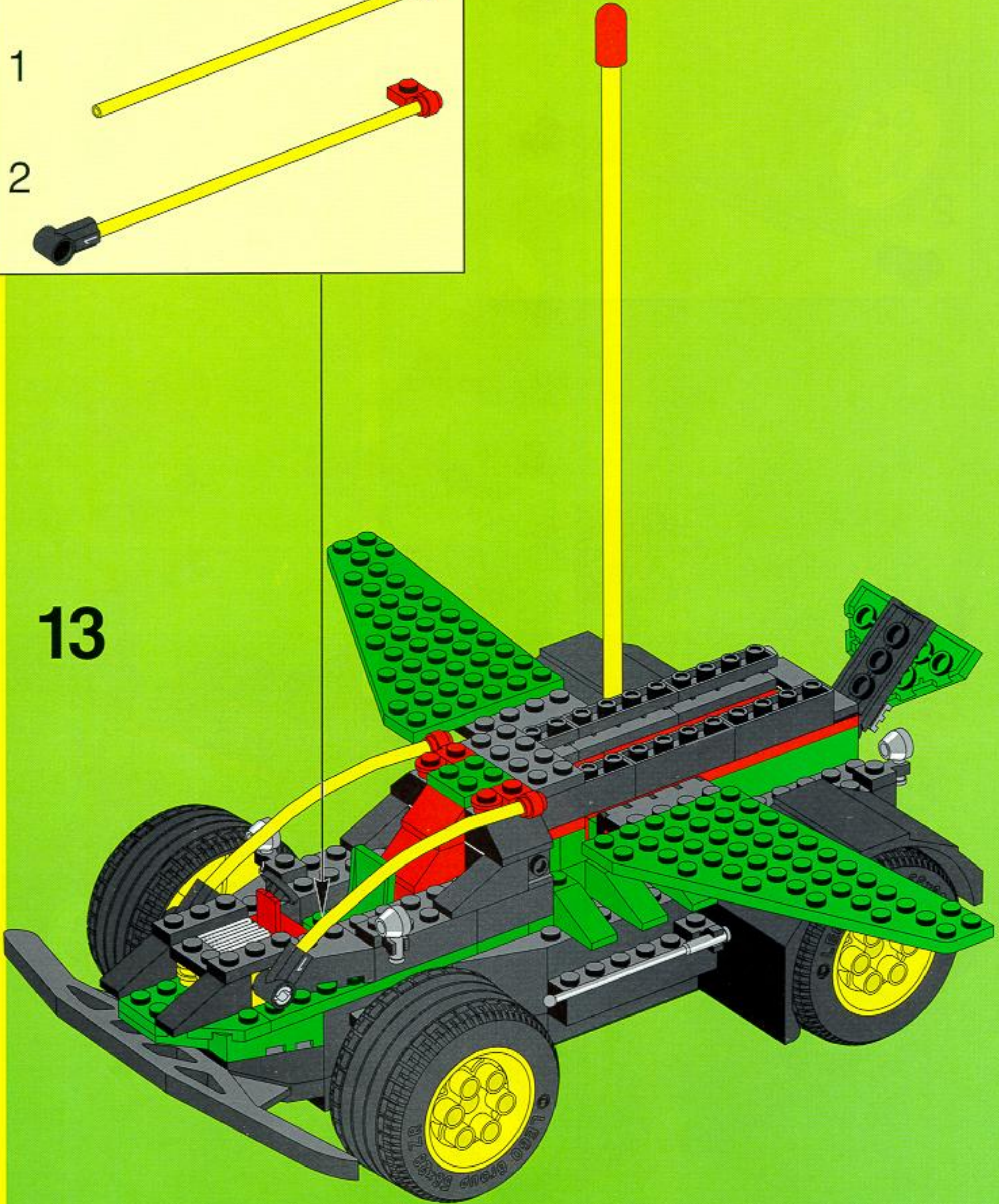

14

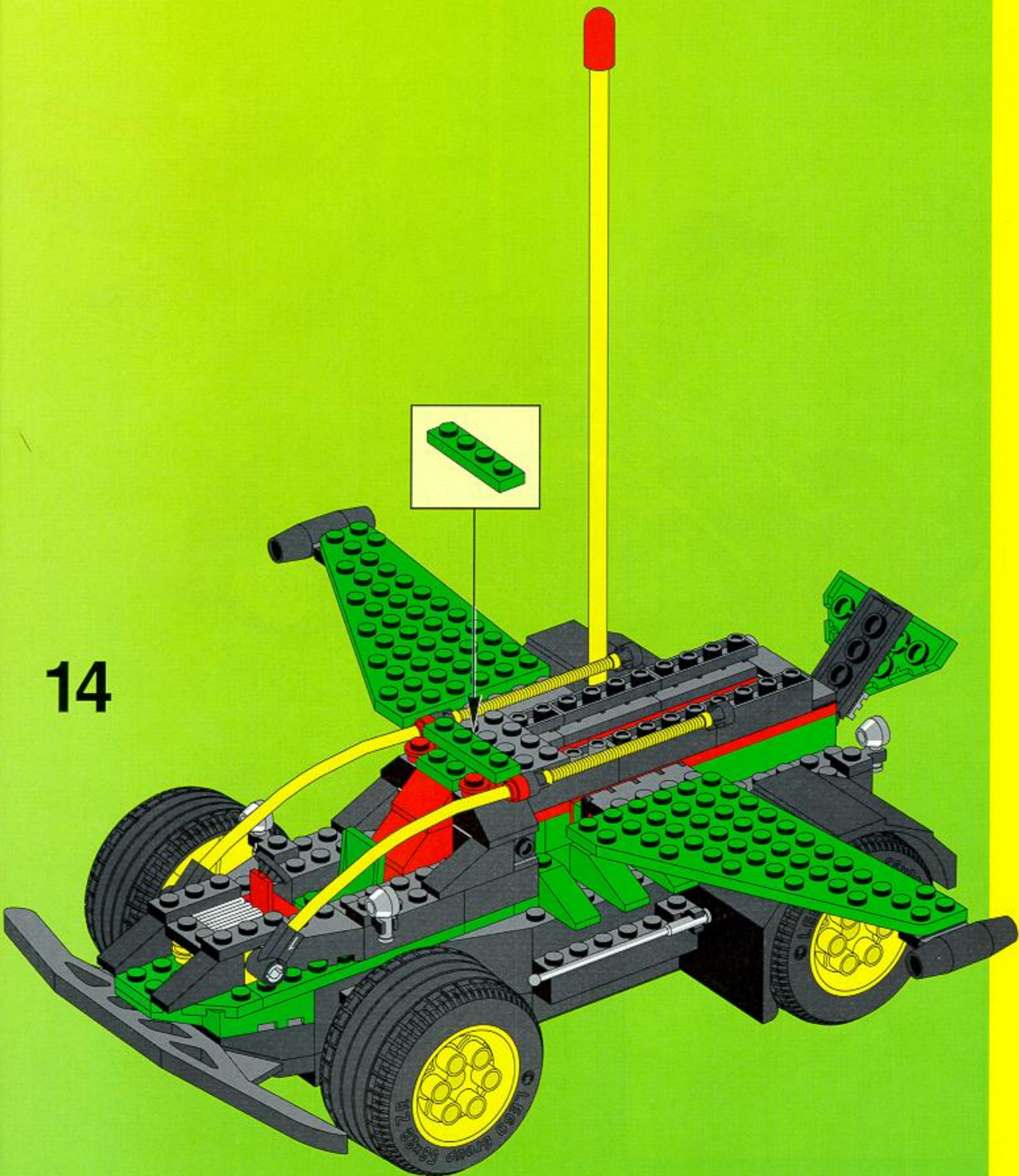

15

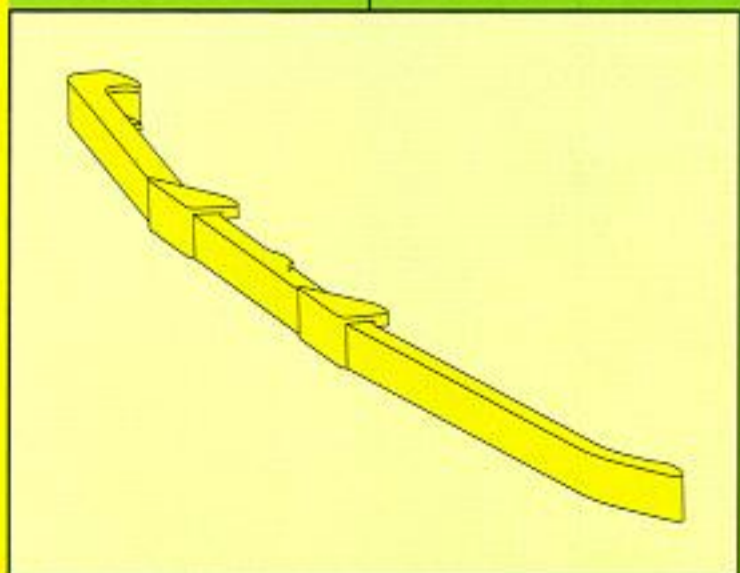
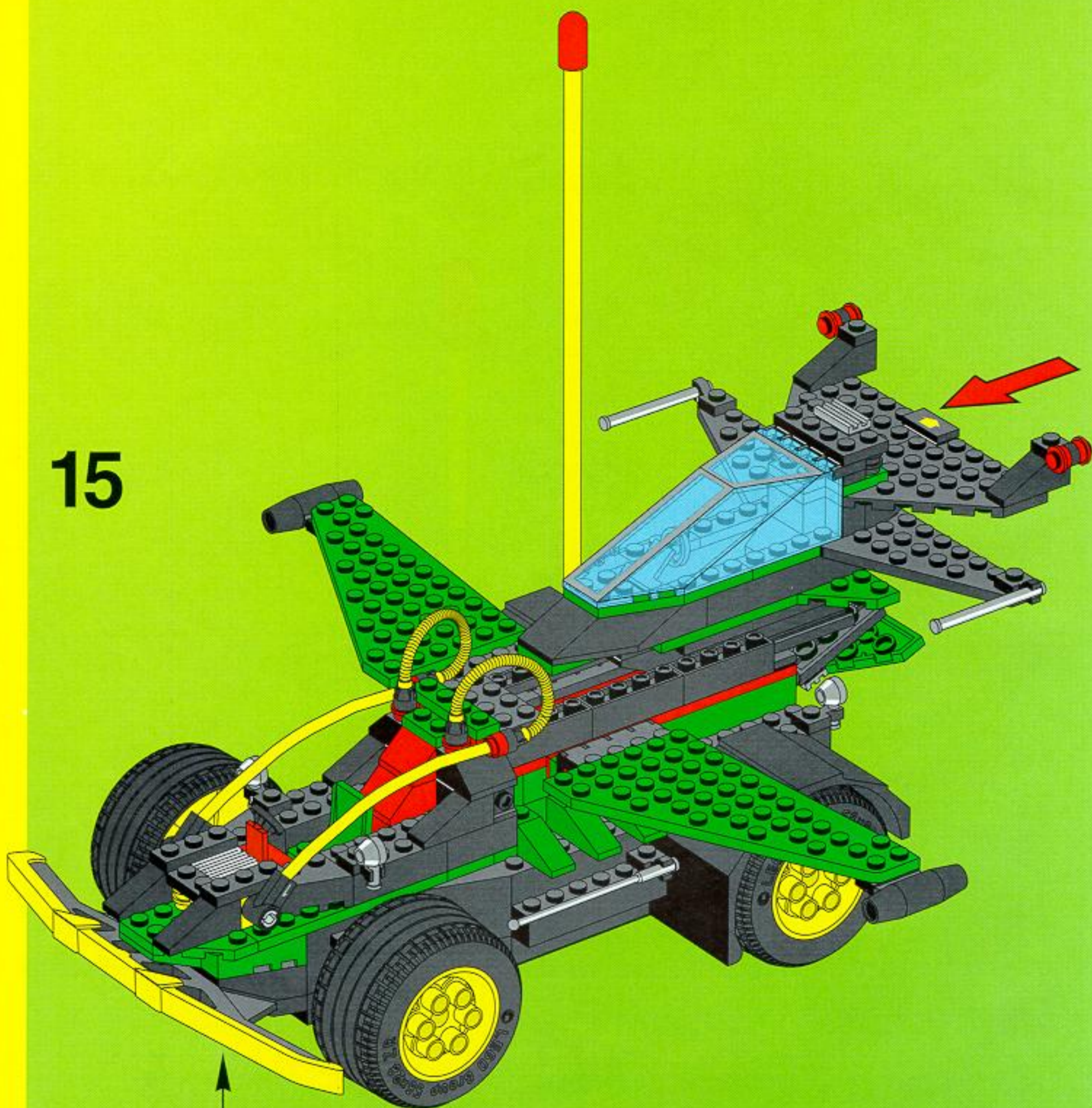

16

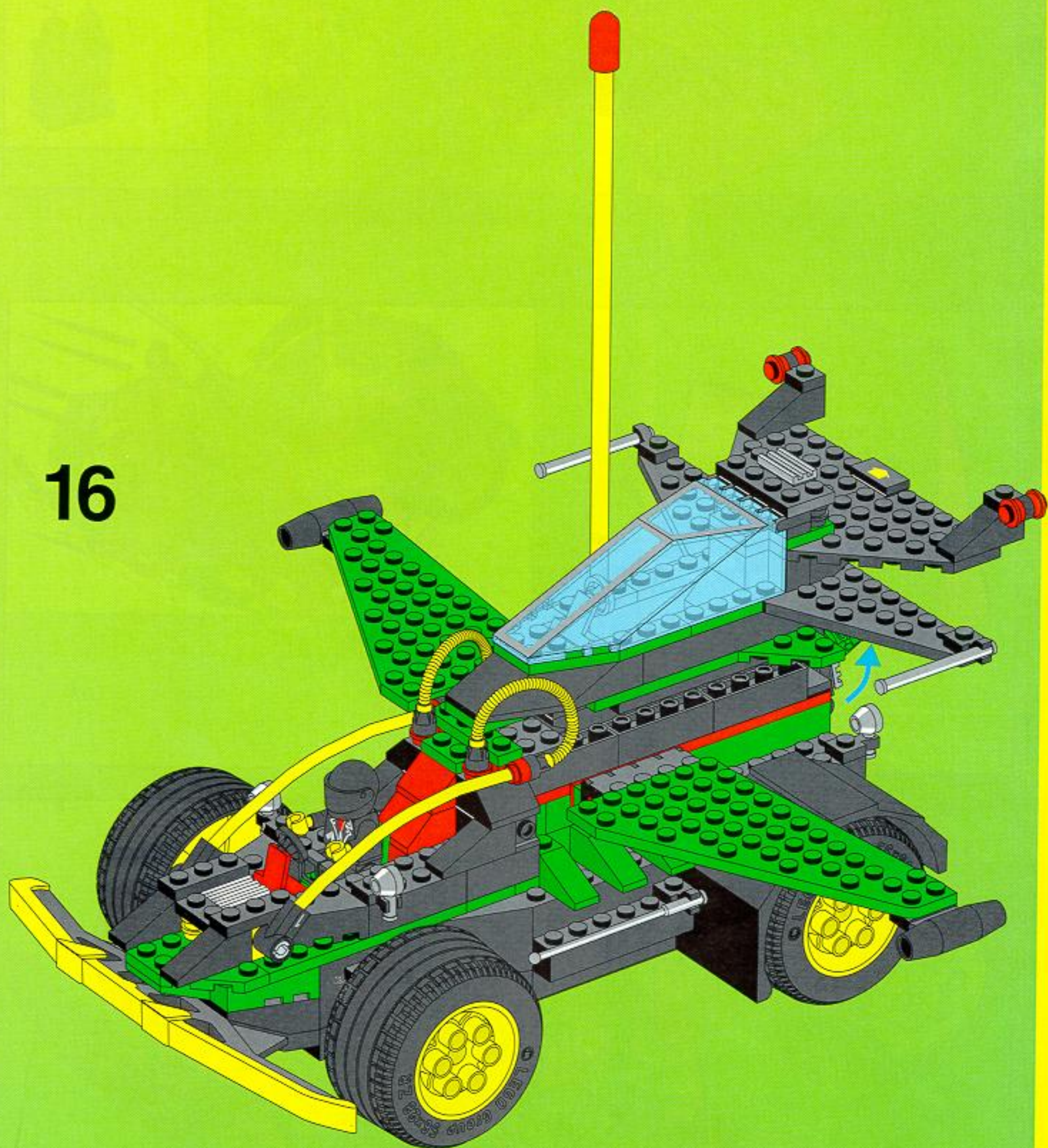

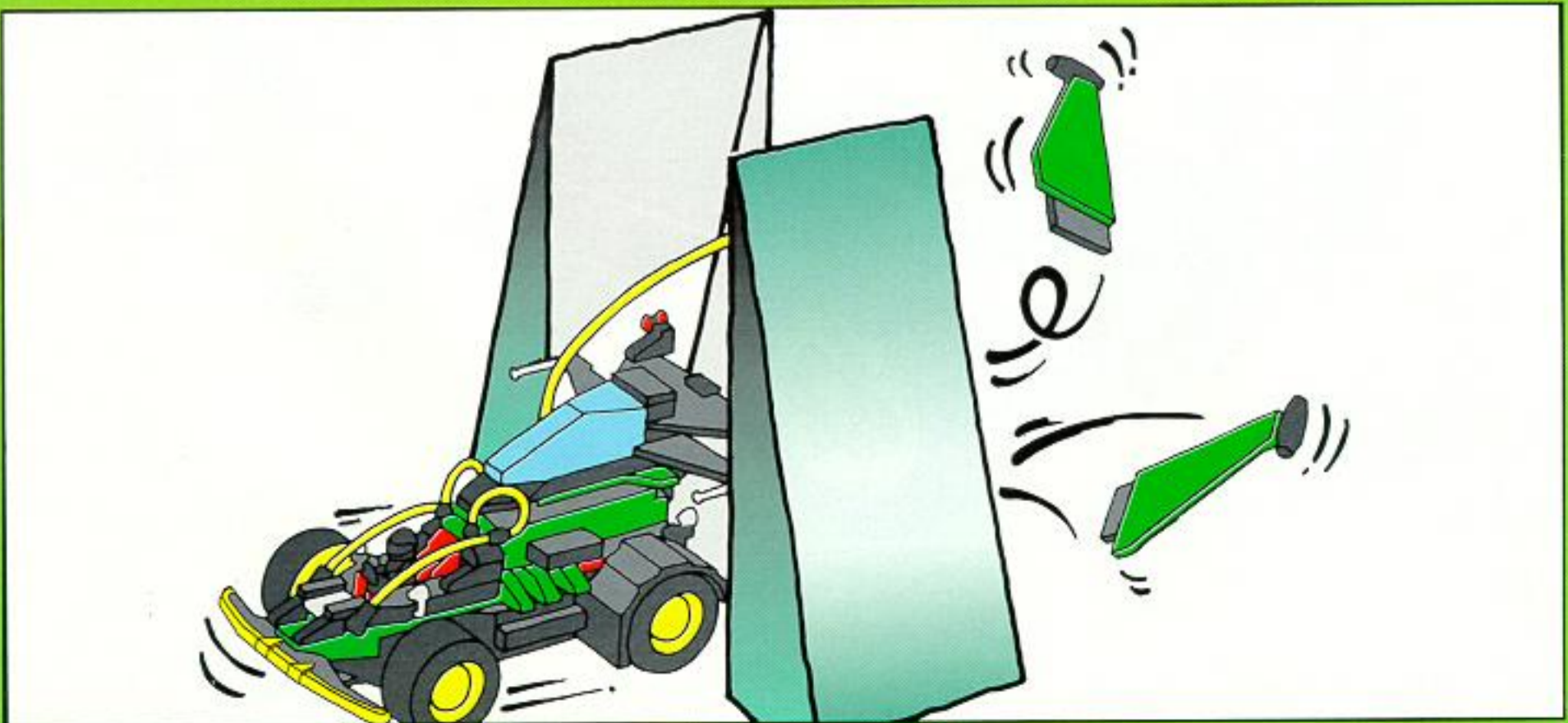
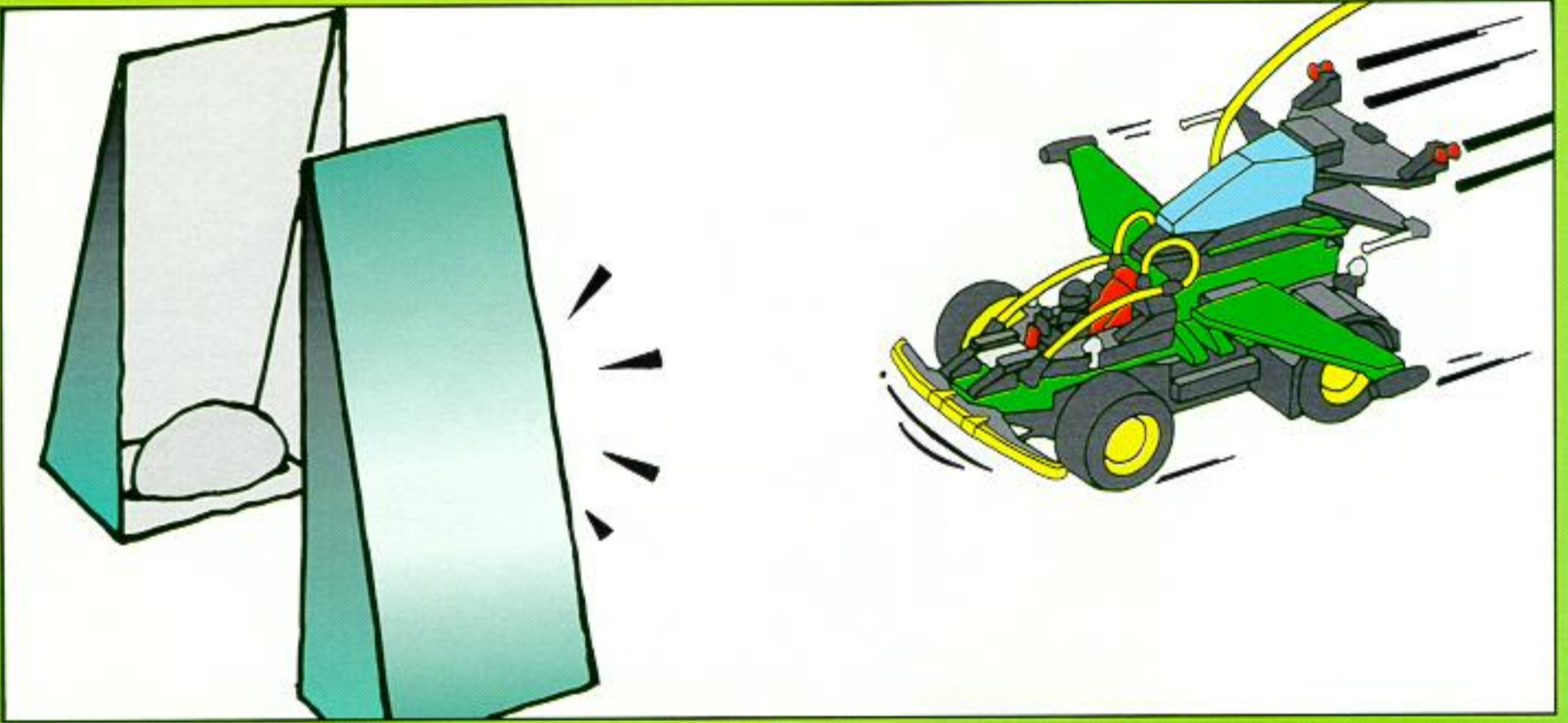
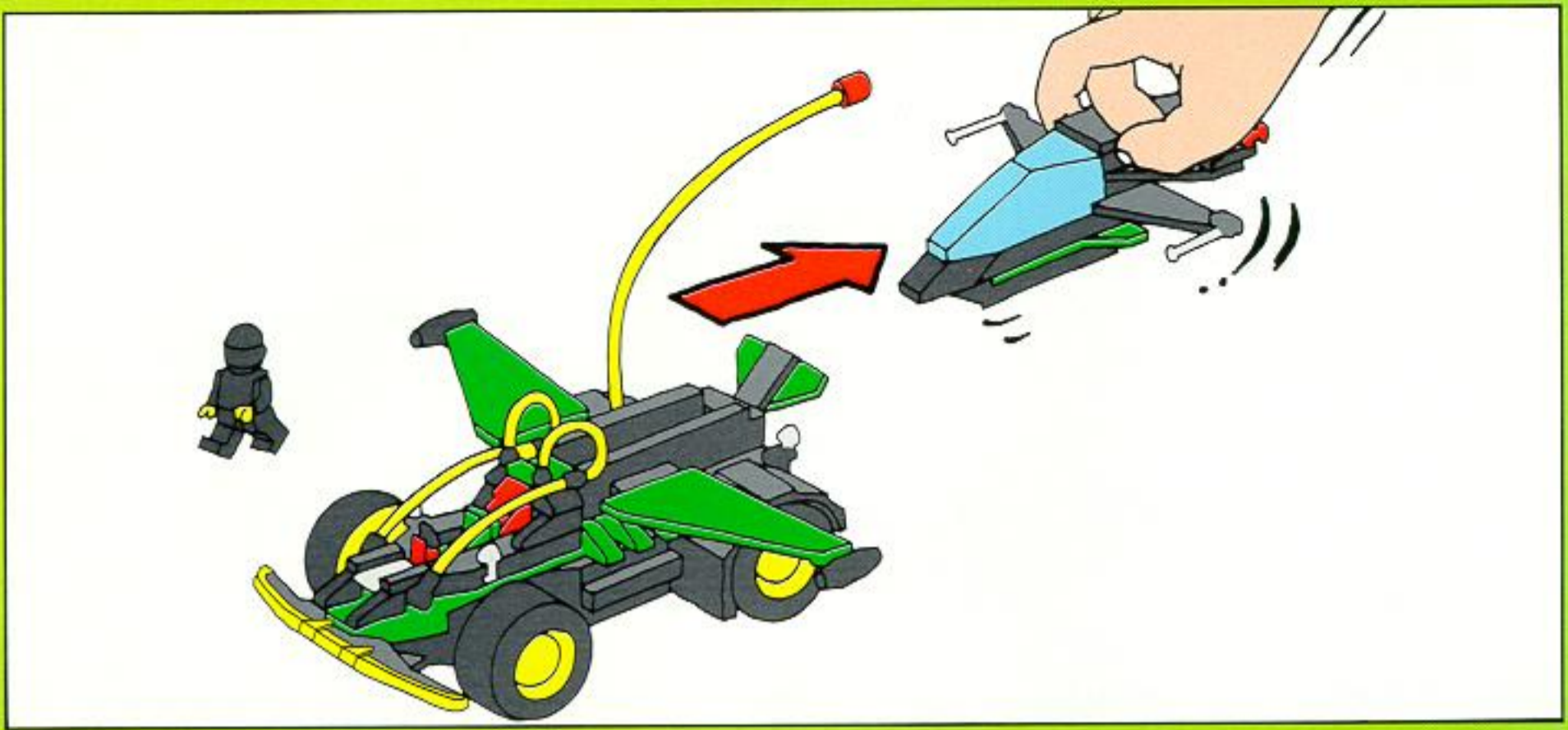

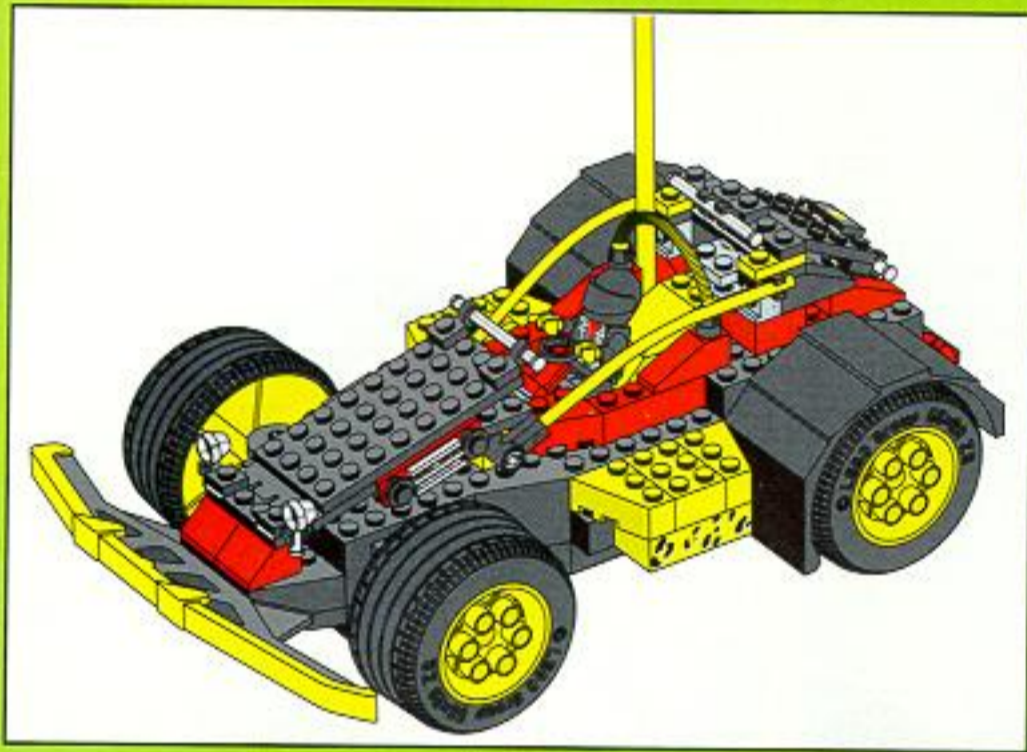
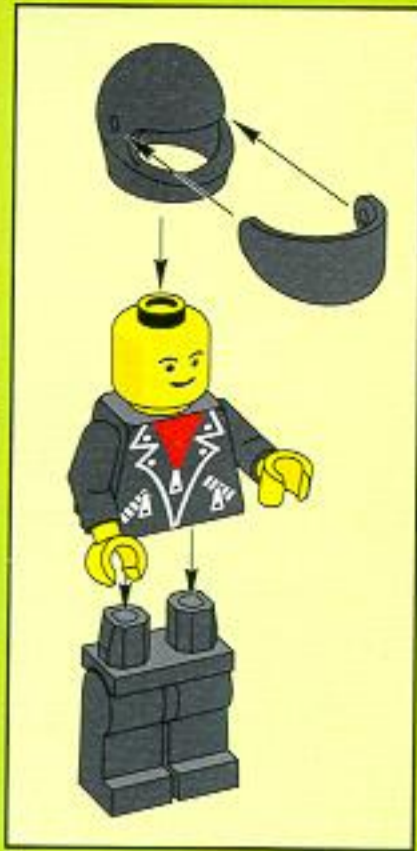

1

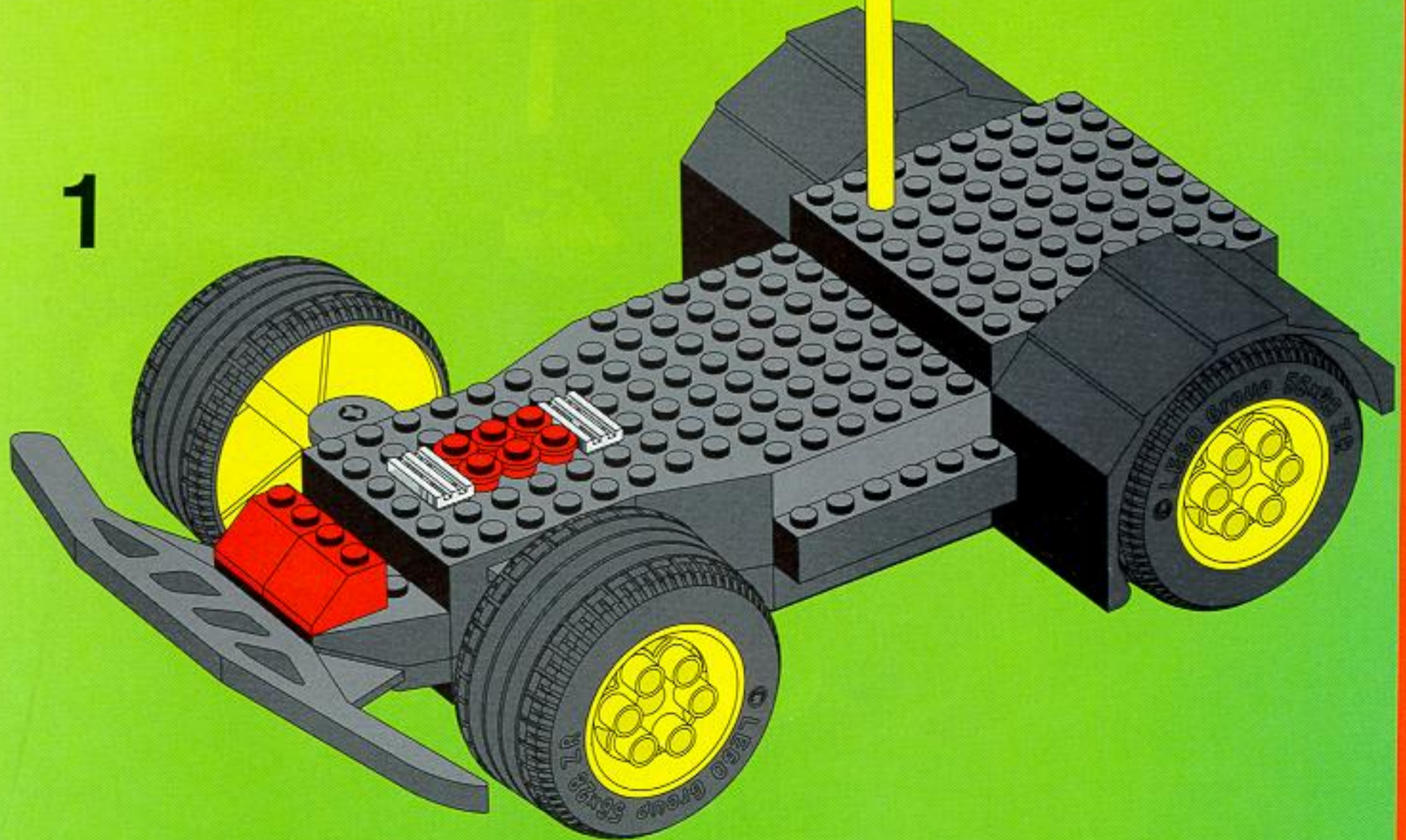

2

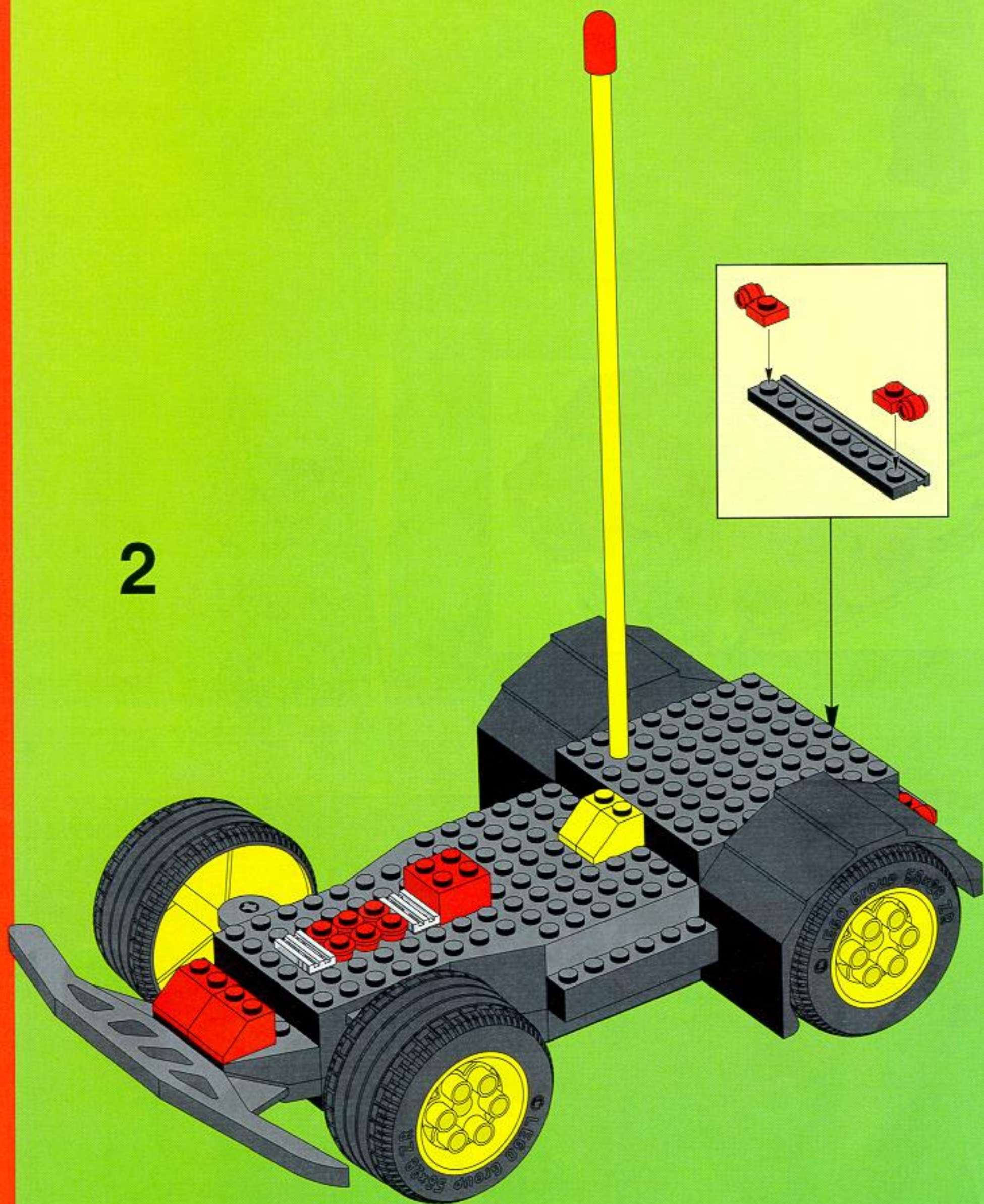

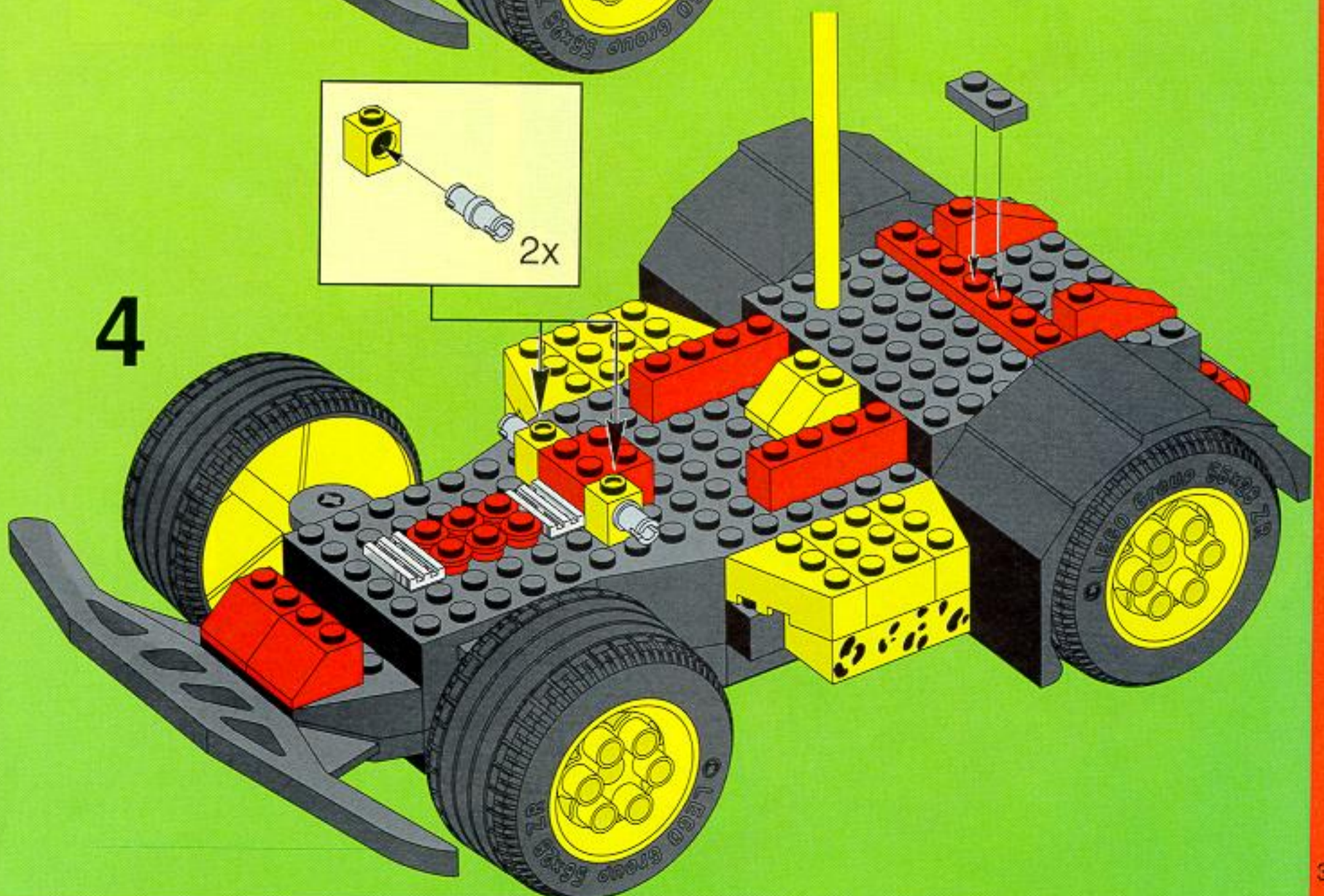
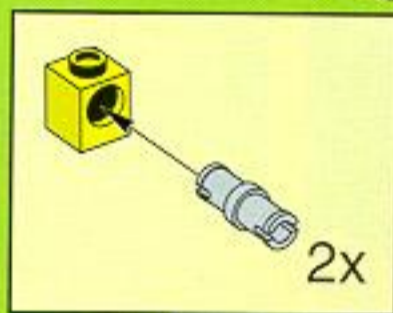
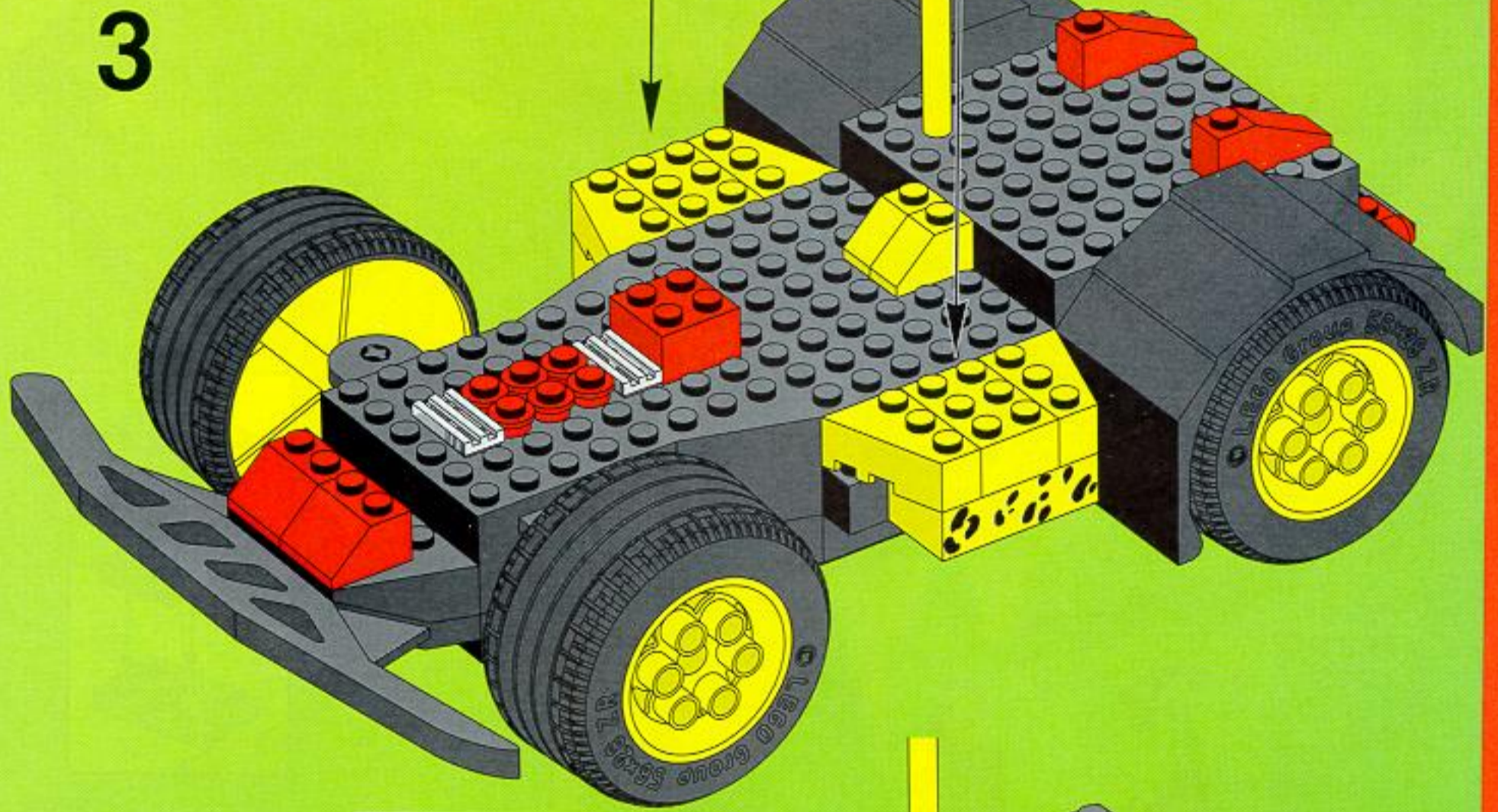
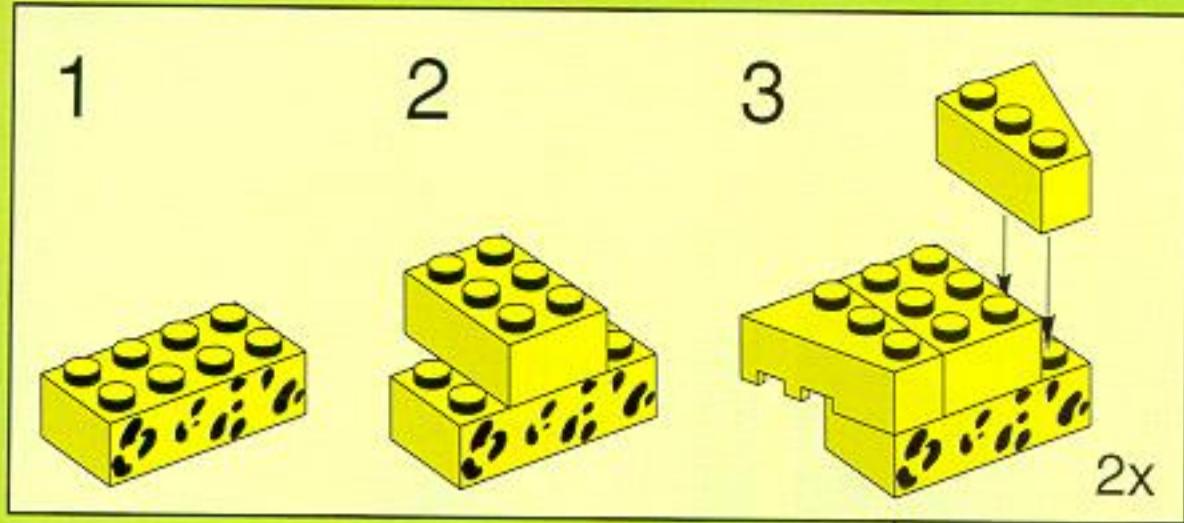

5

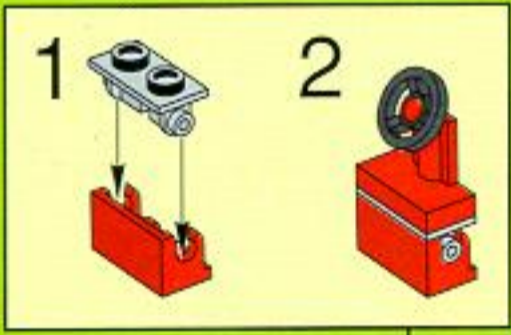
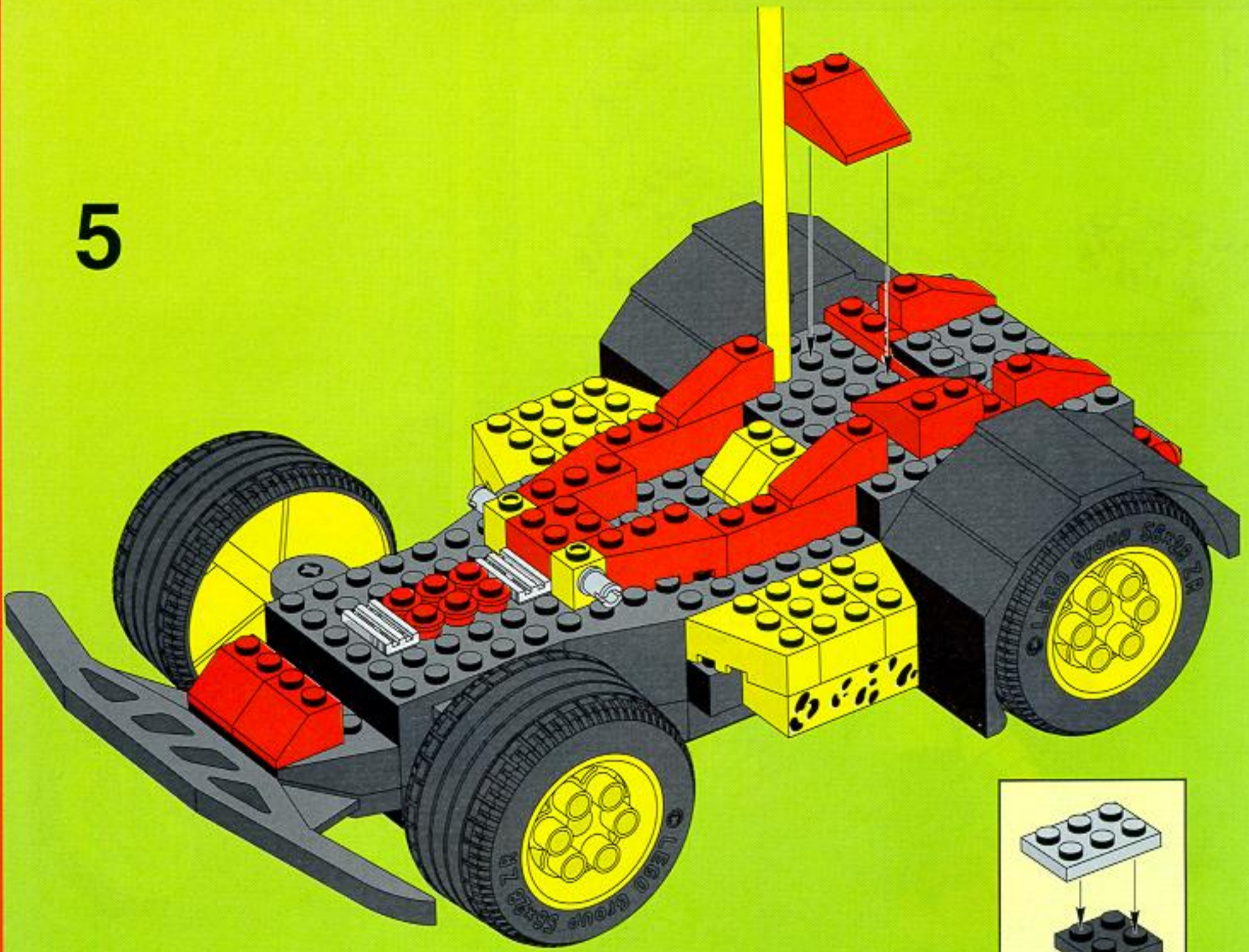

6

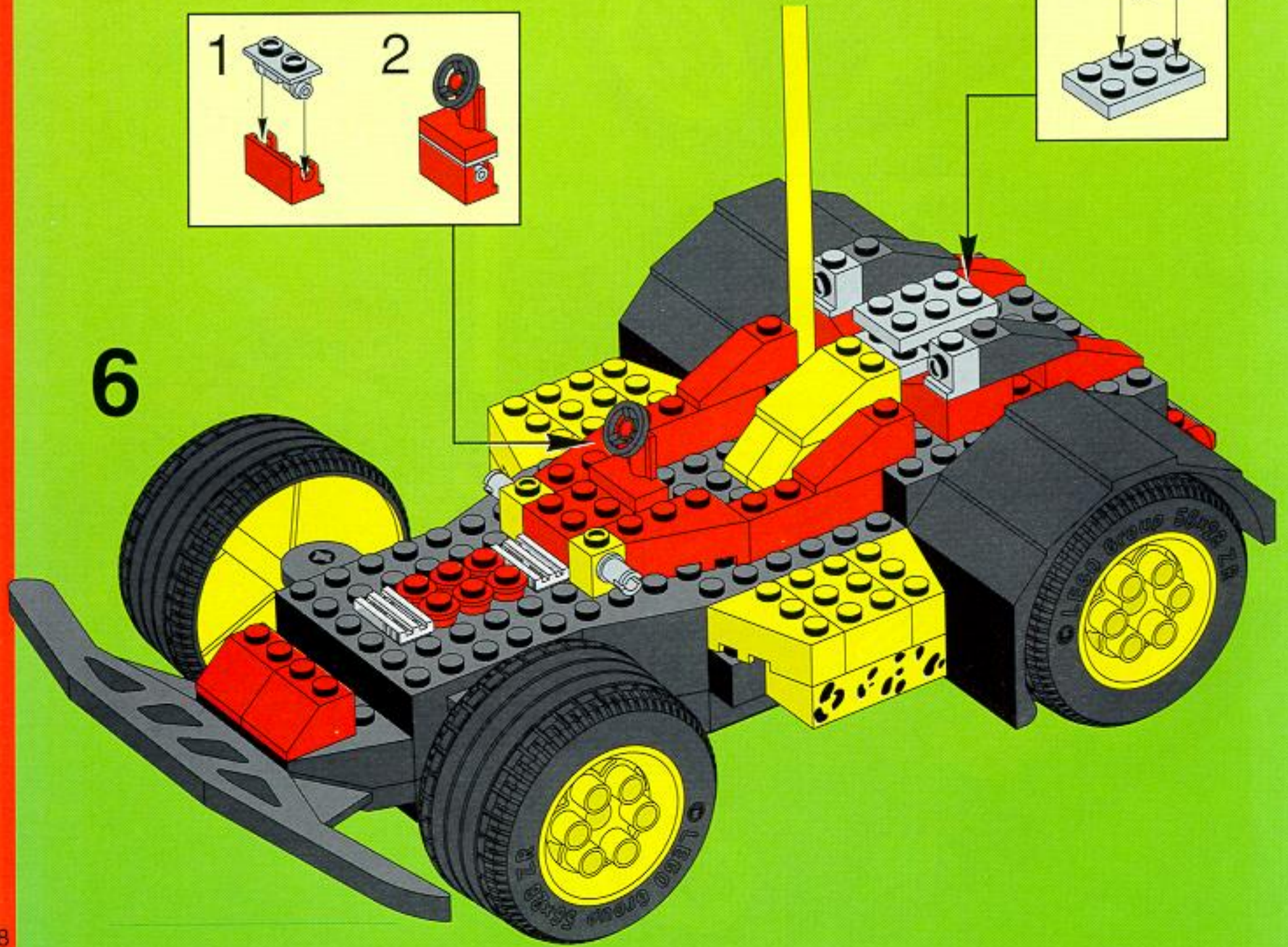

7

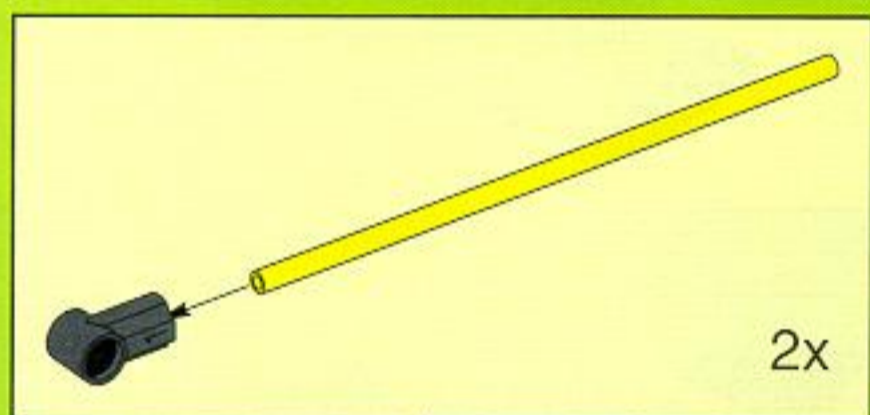
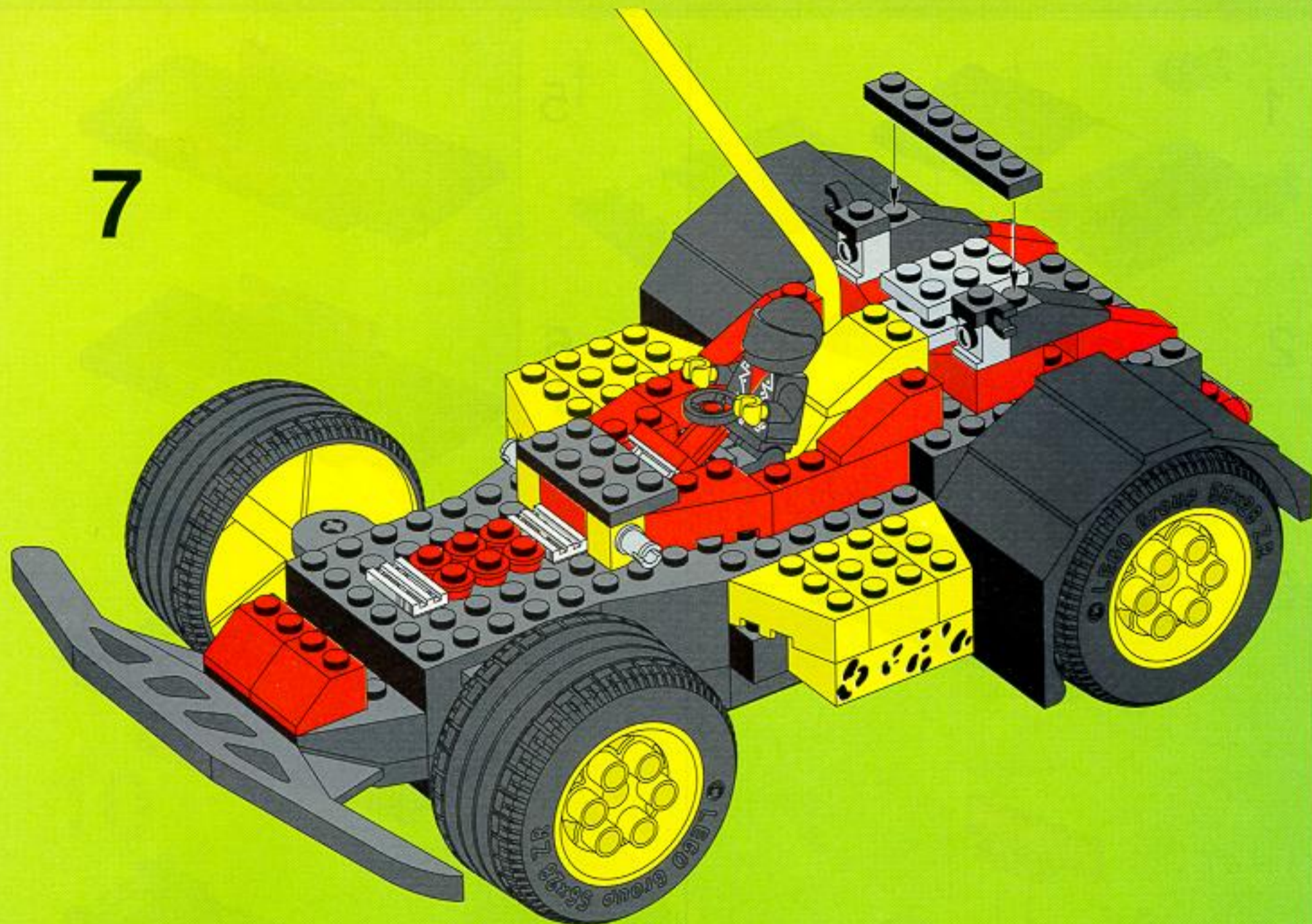

8

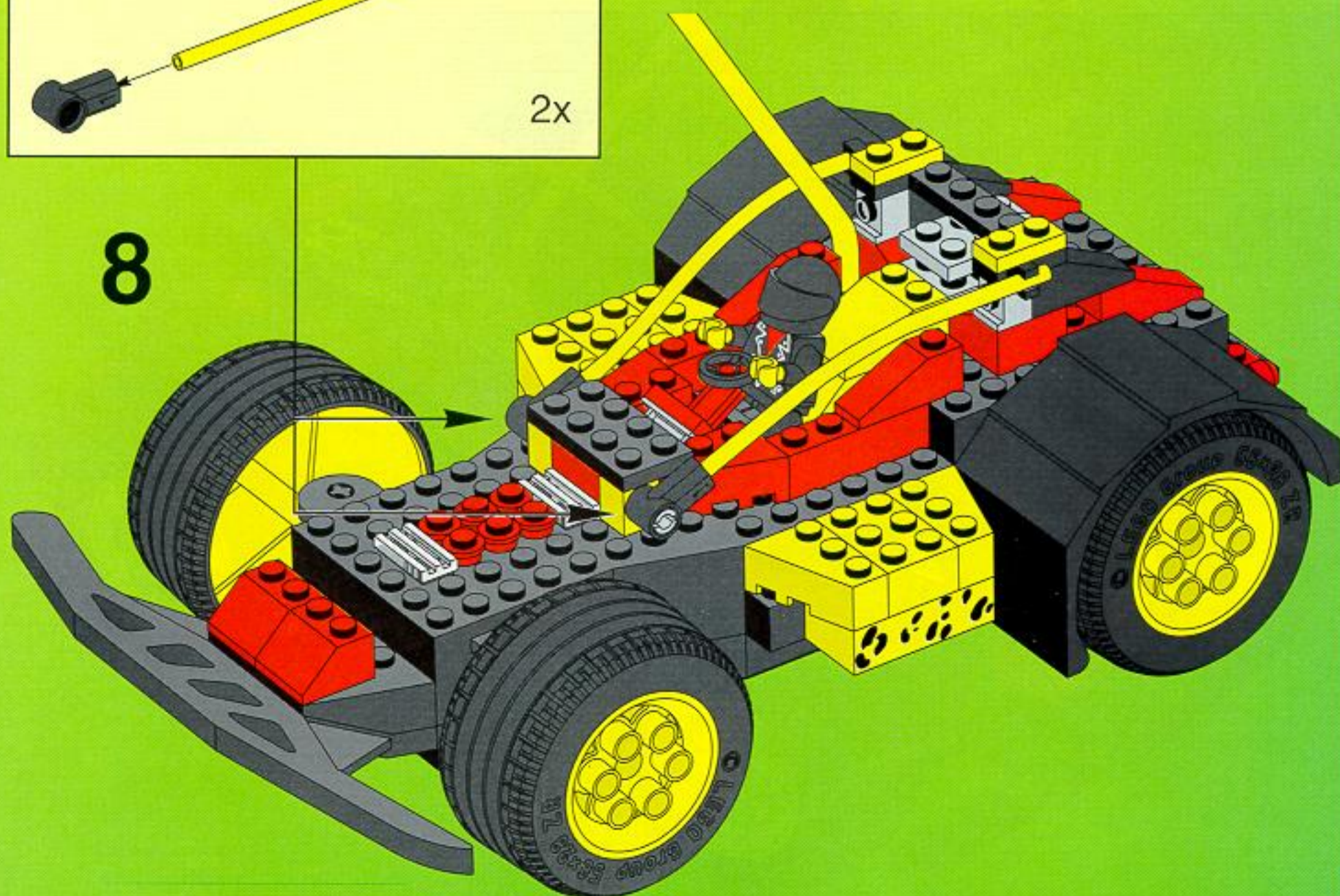

1

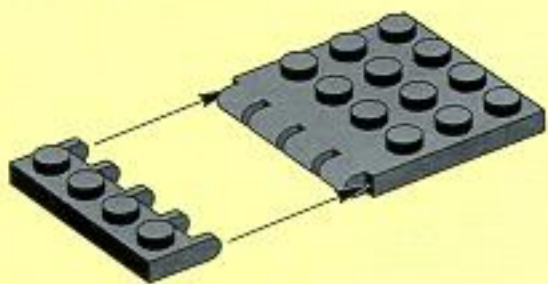

2



3

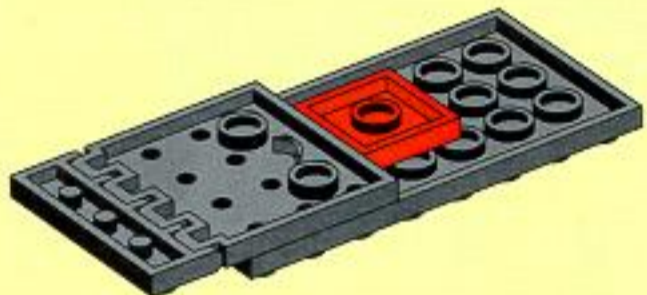

4

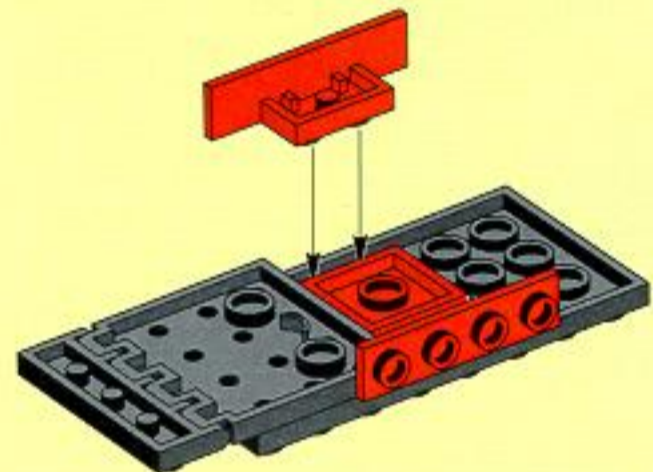

5

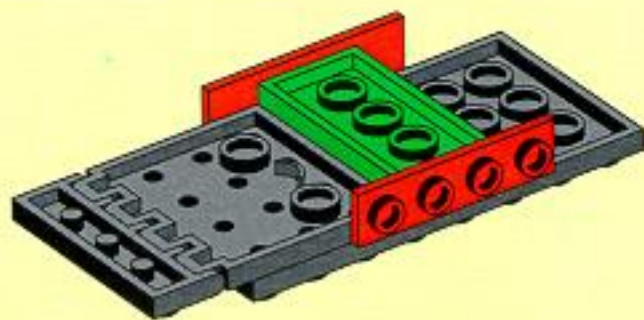

6

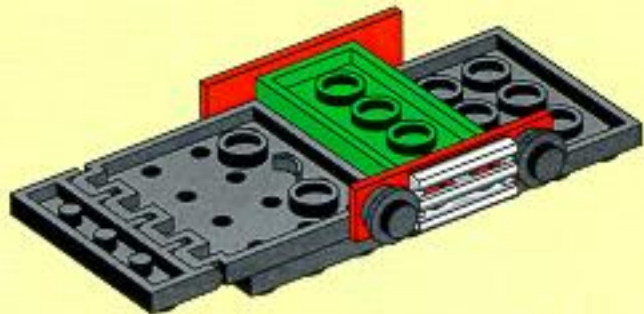

7

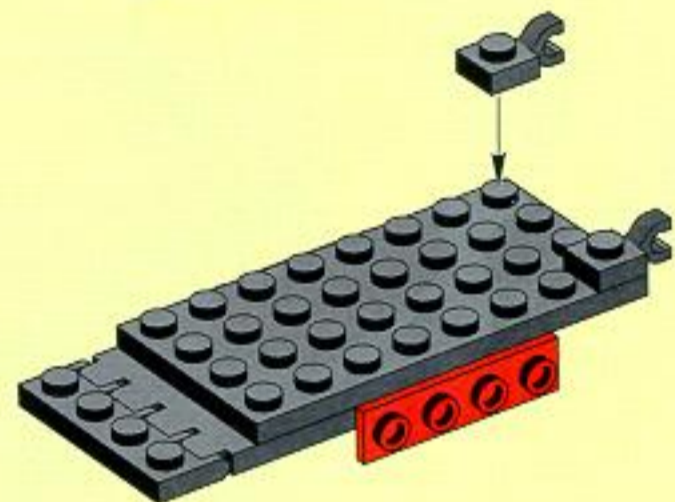

8

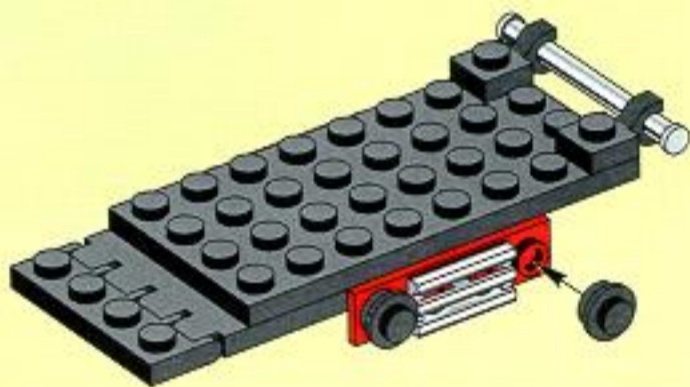

9

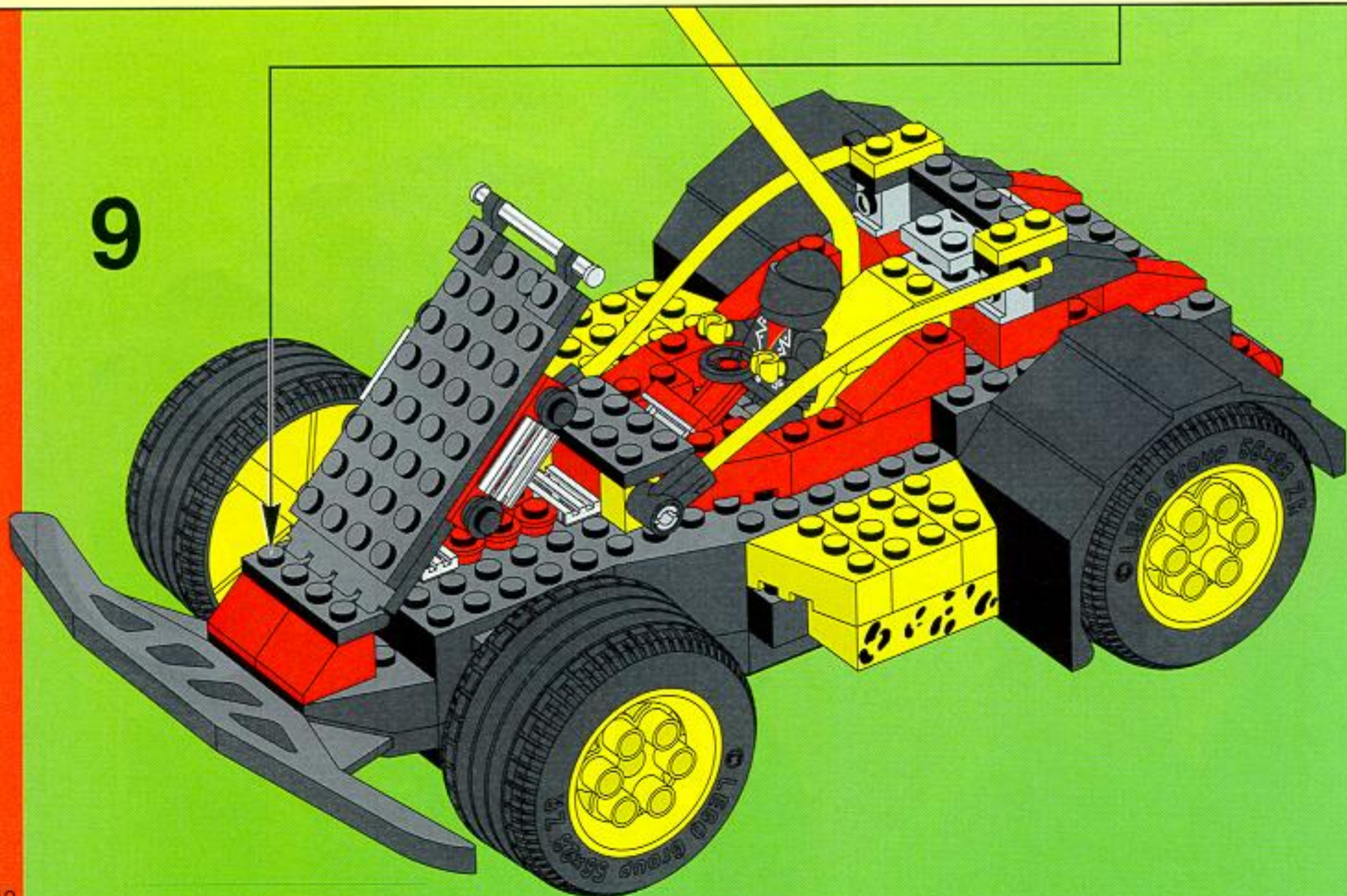

10

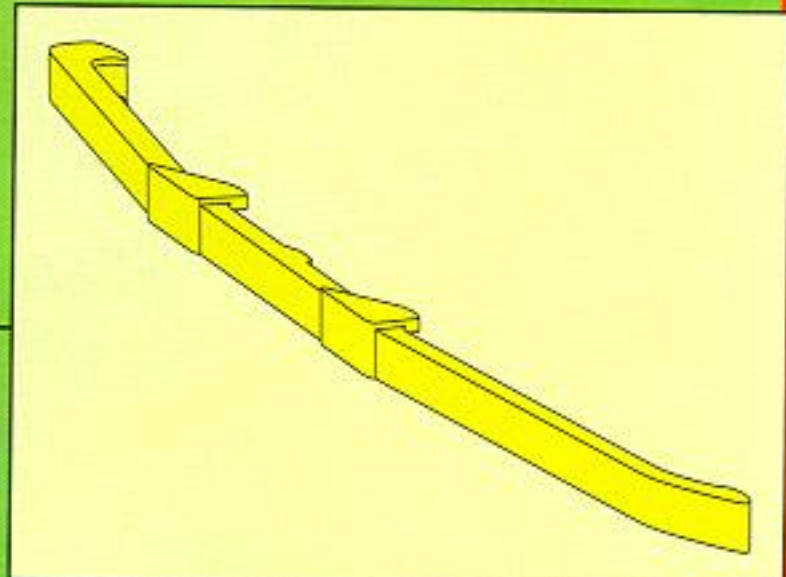
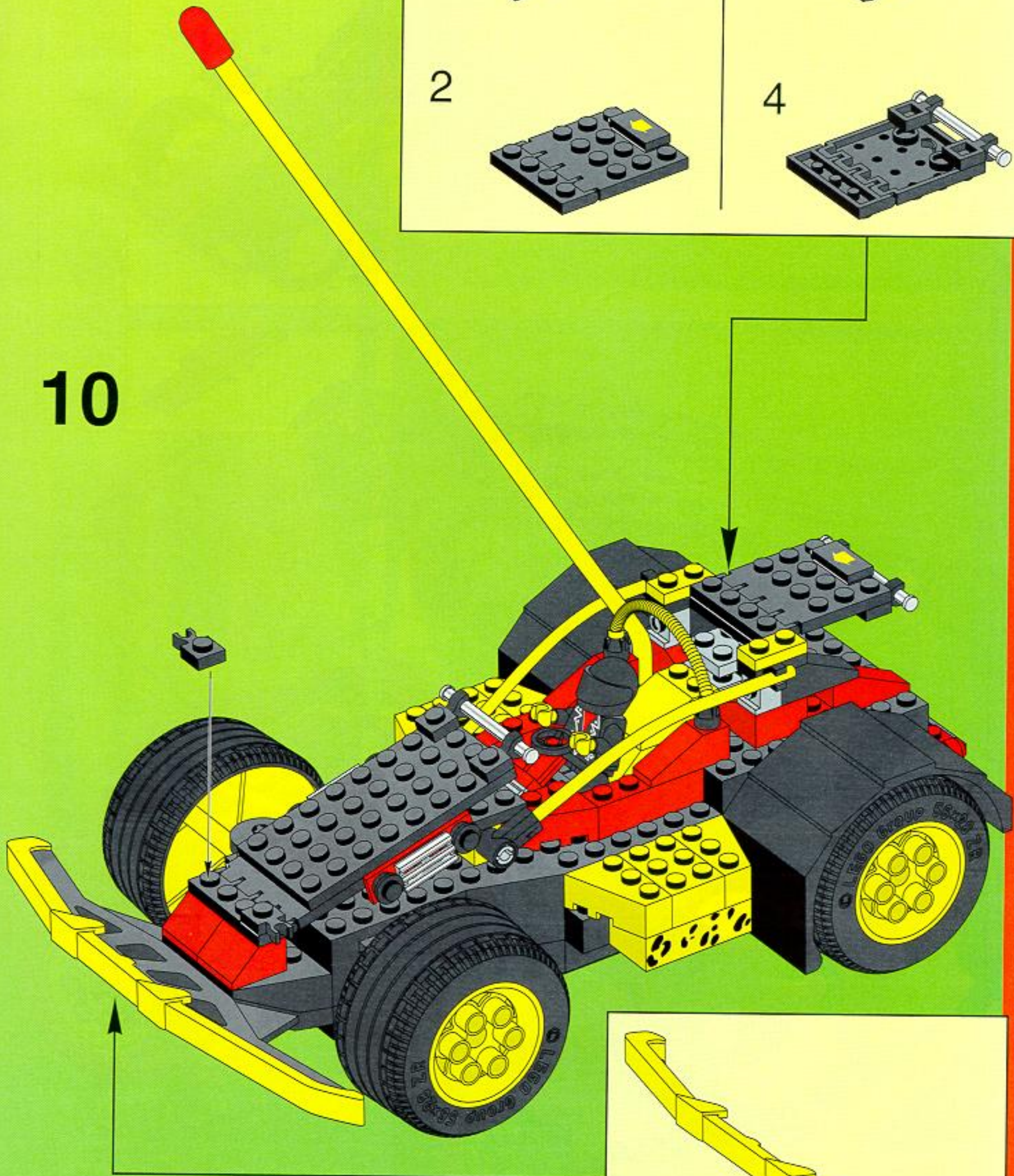
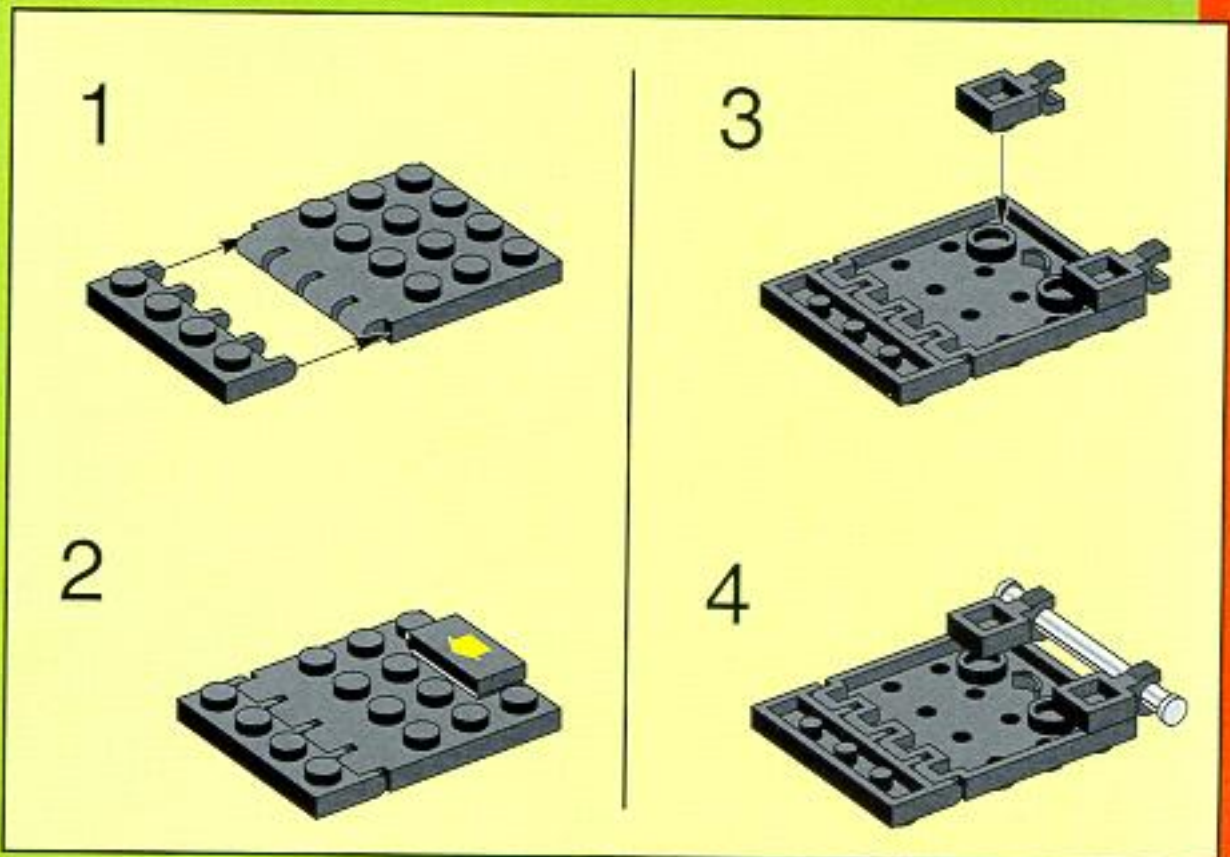

11

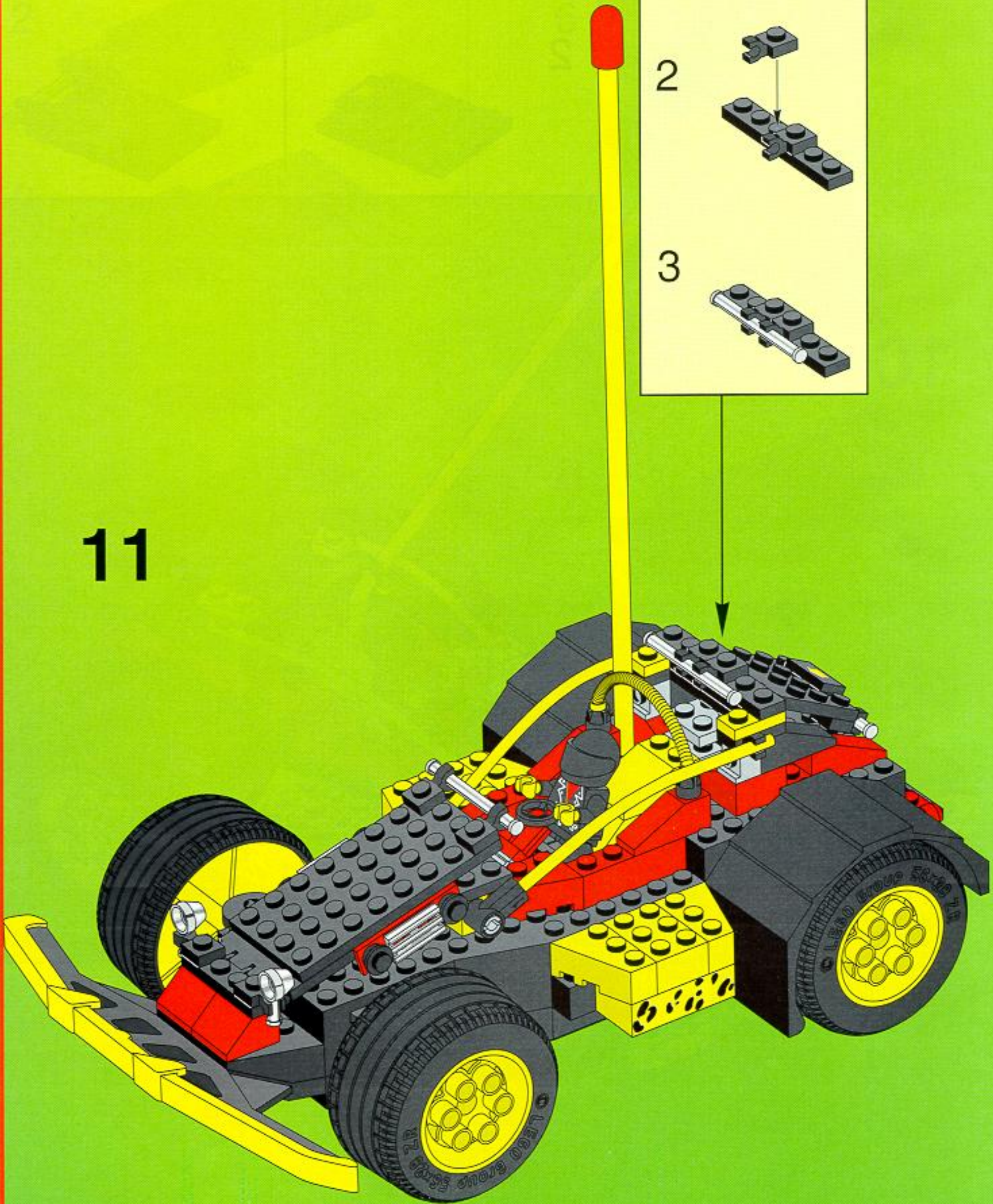
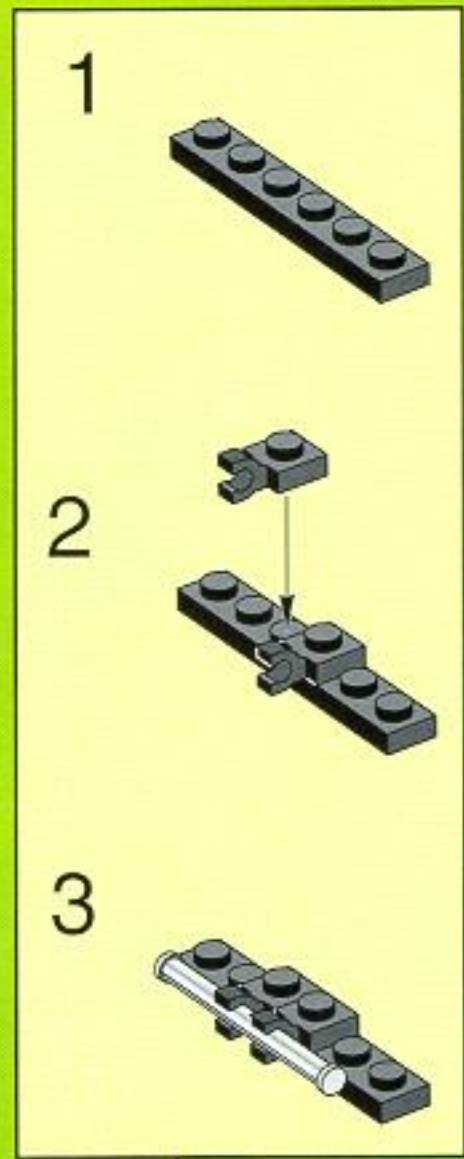

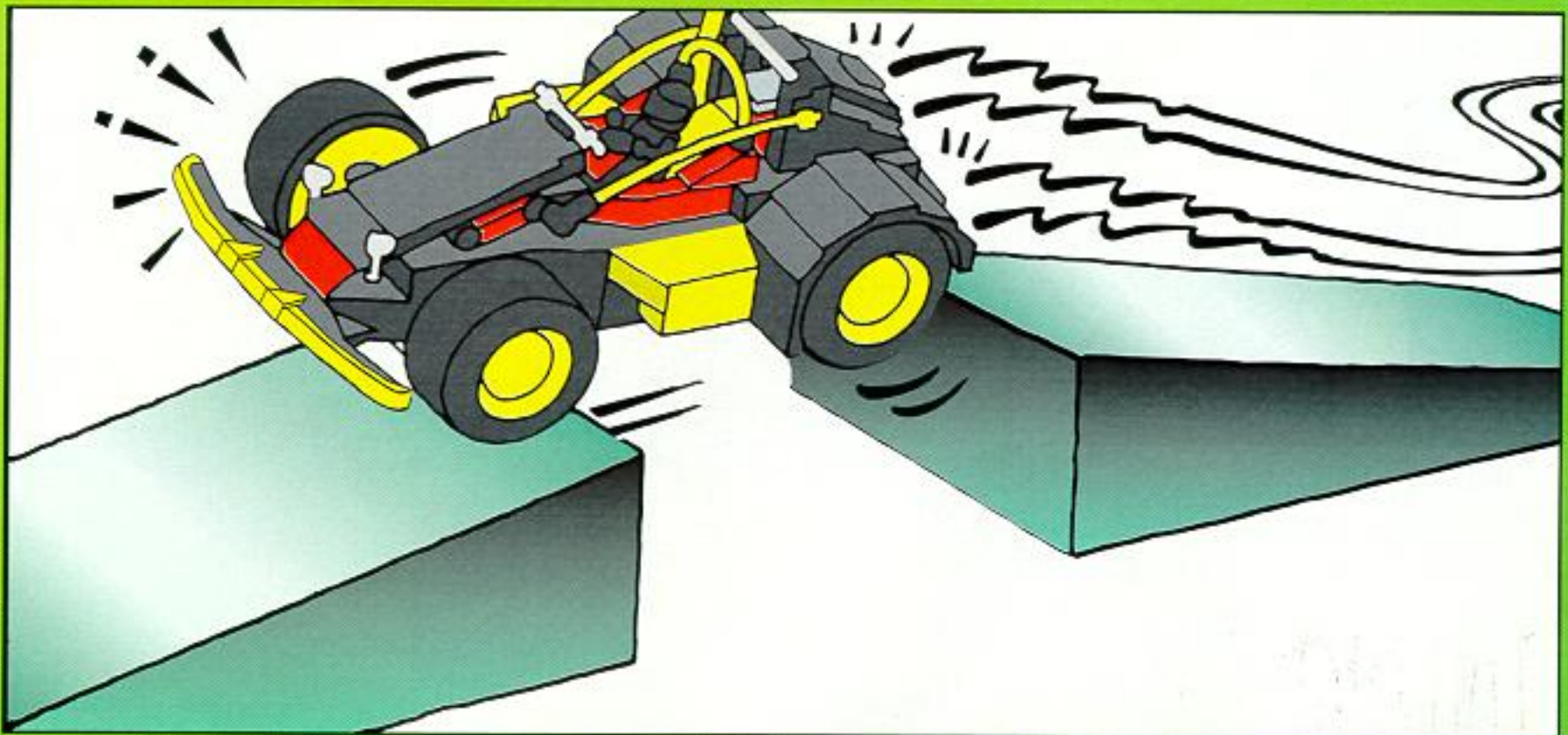
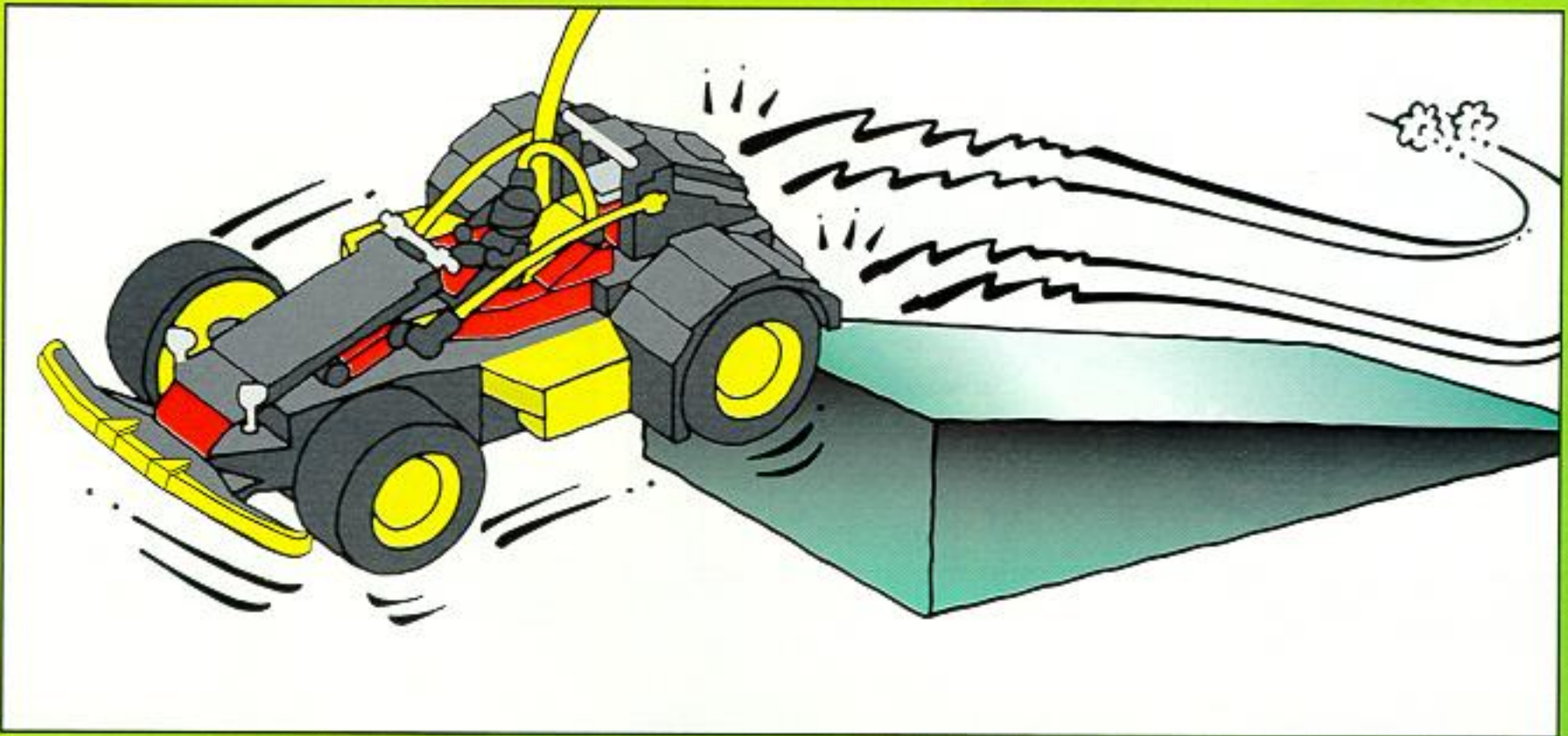
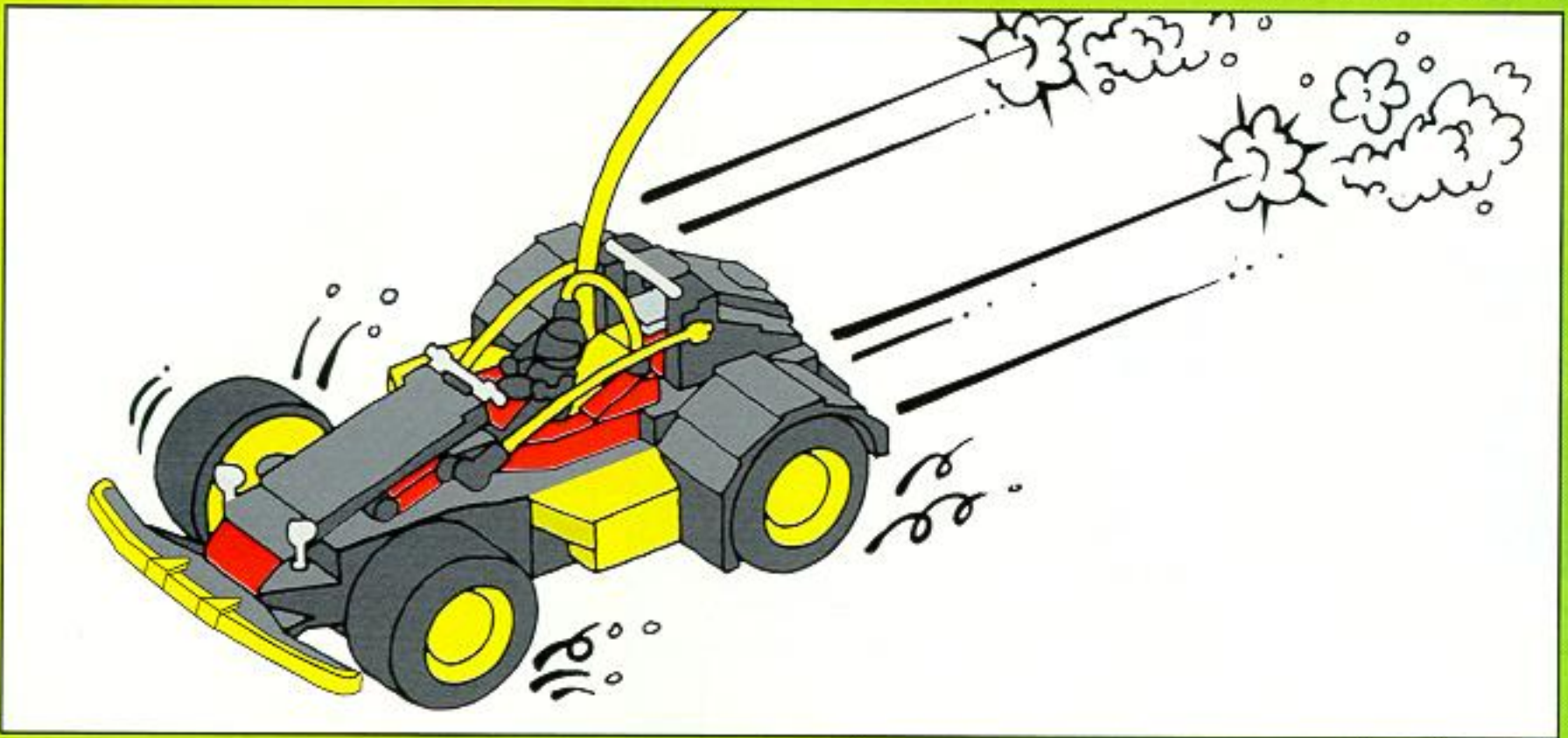

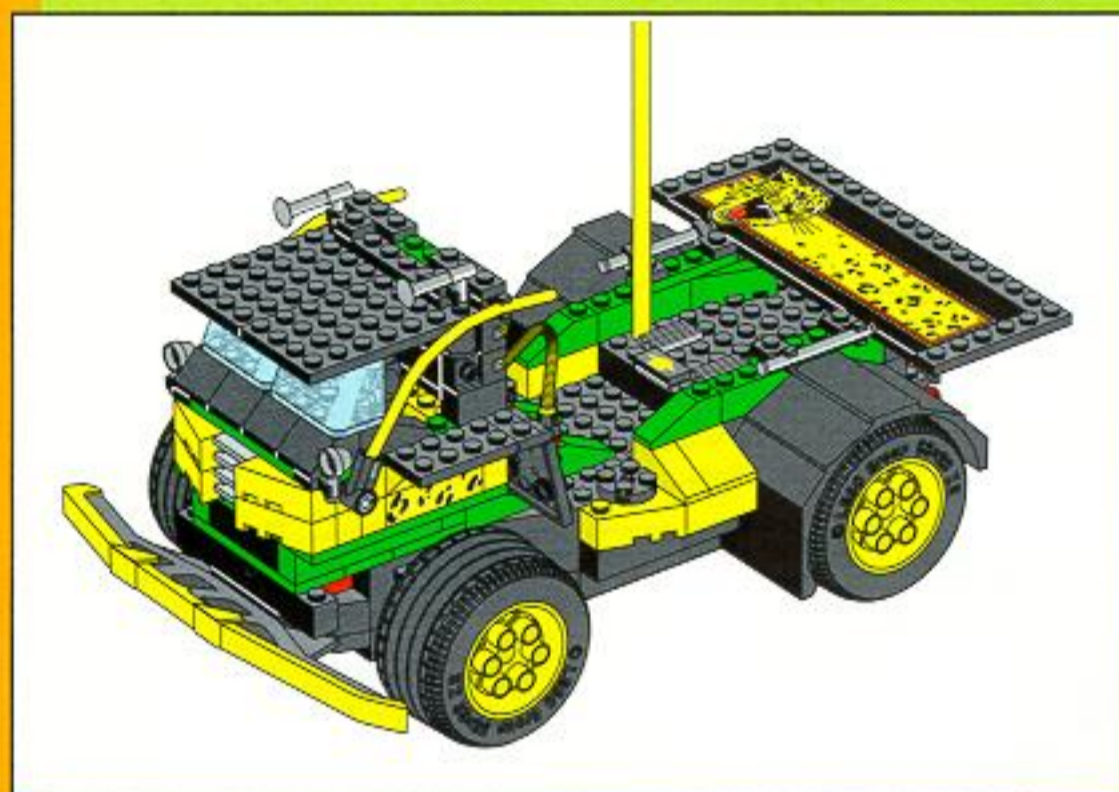
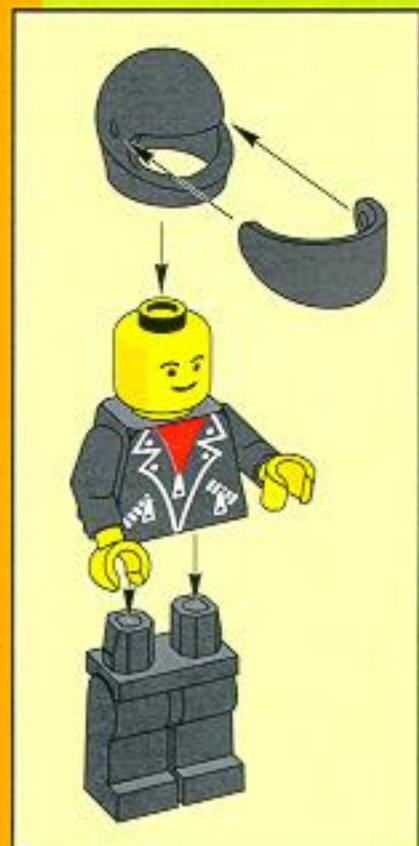

1

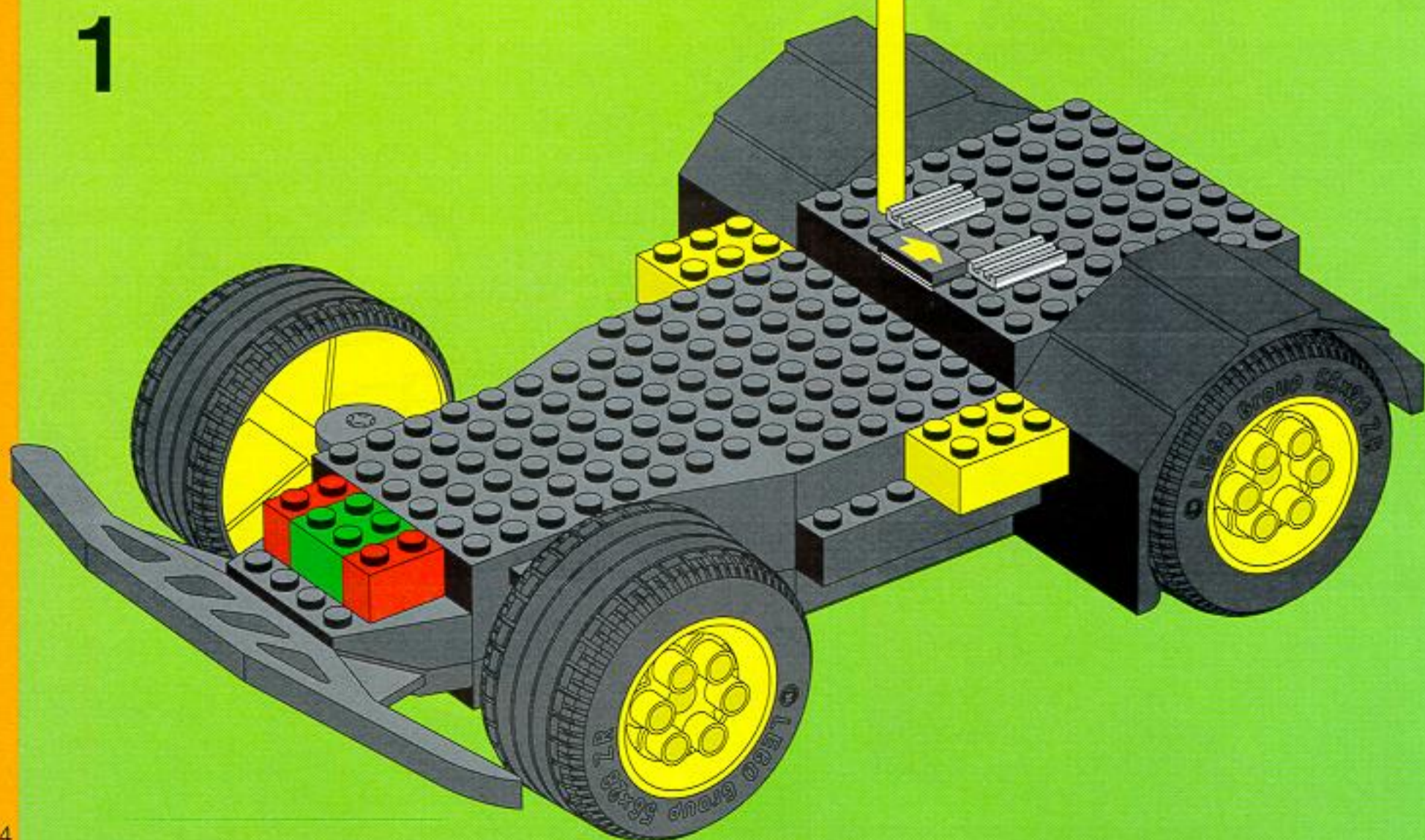

2

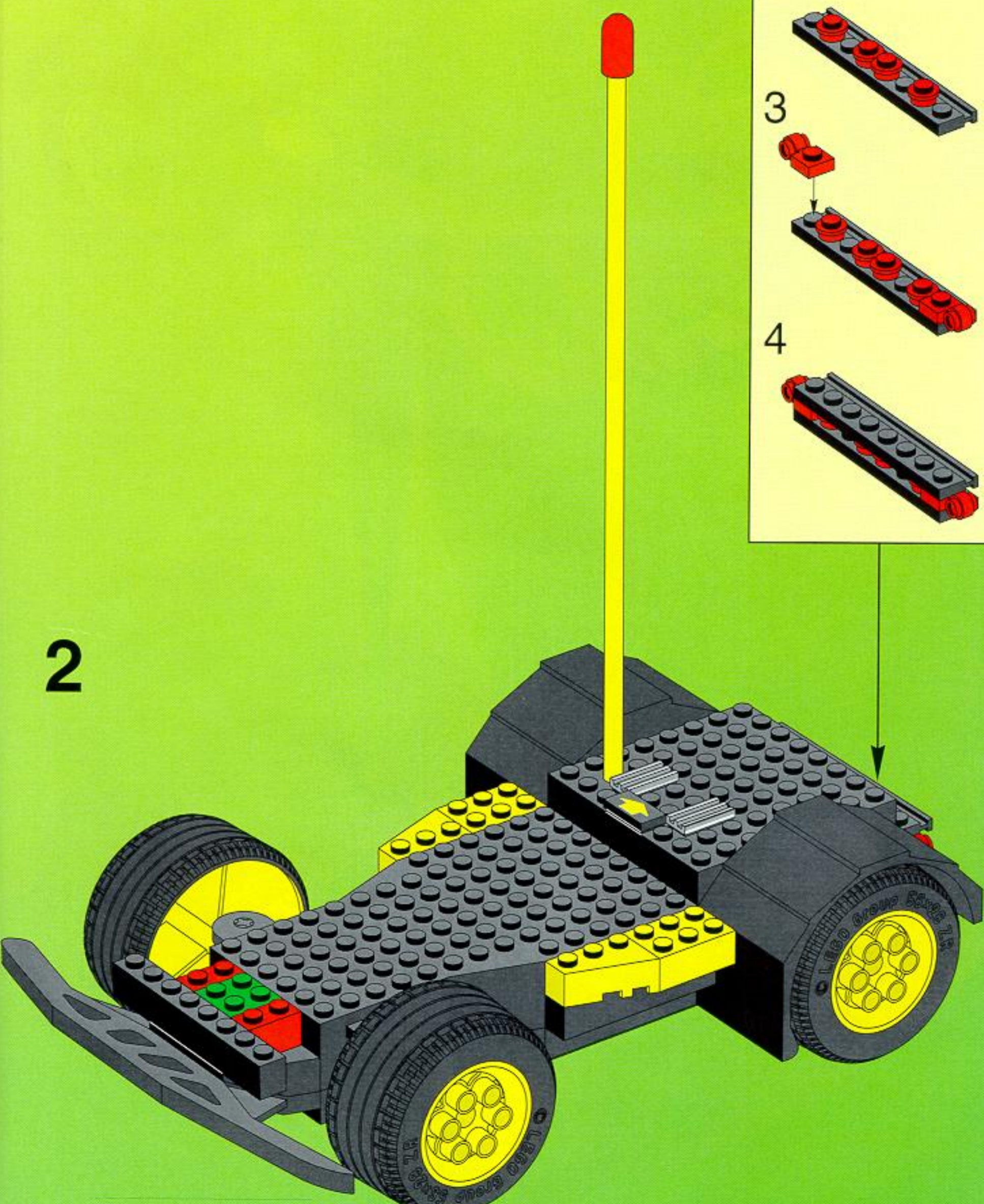
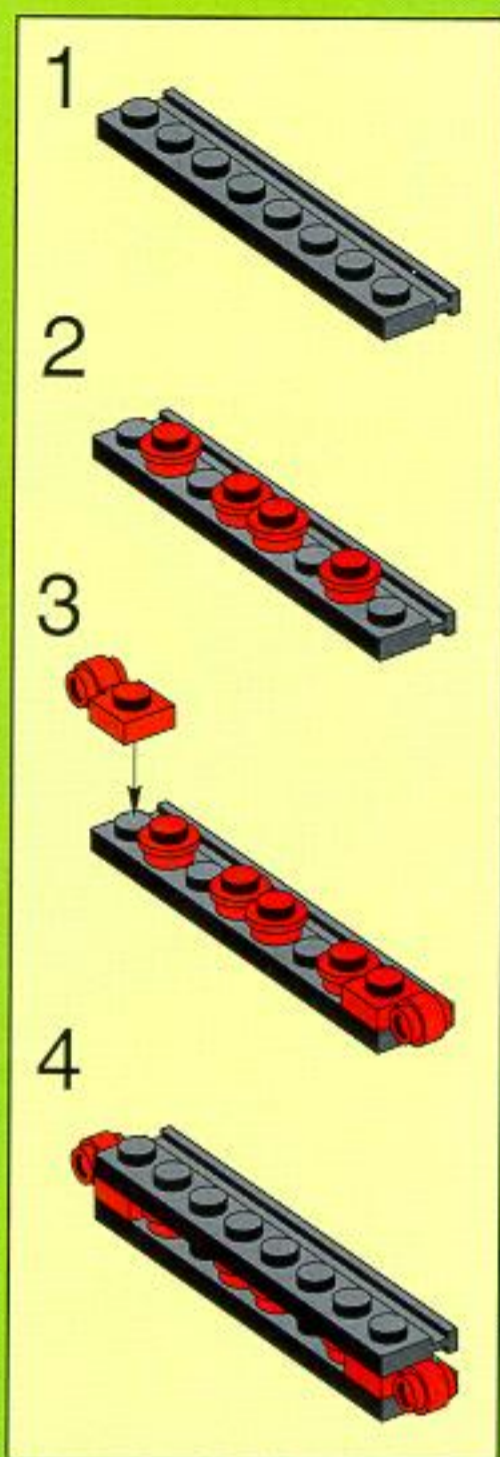

3

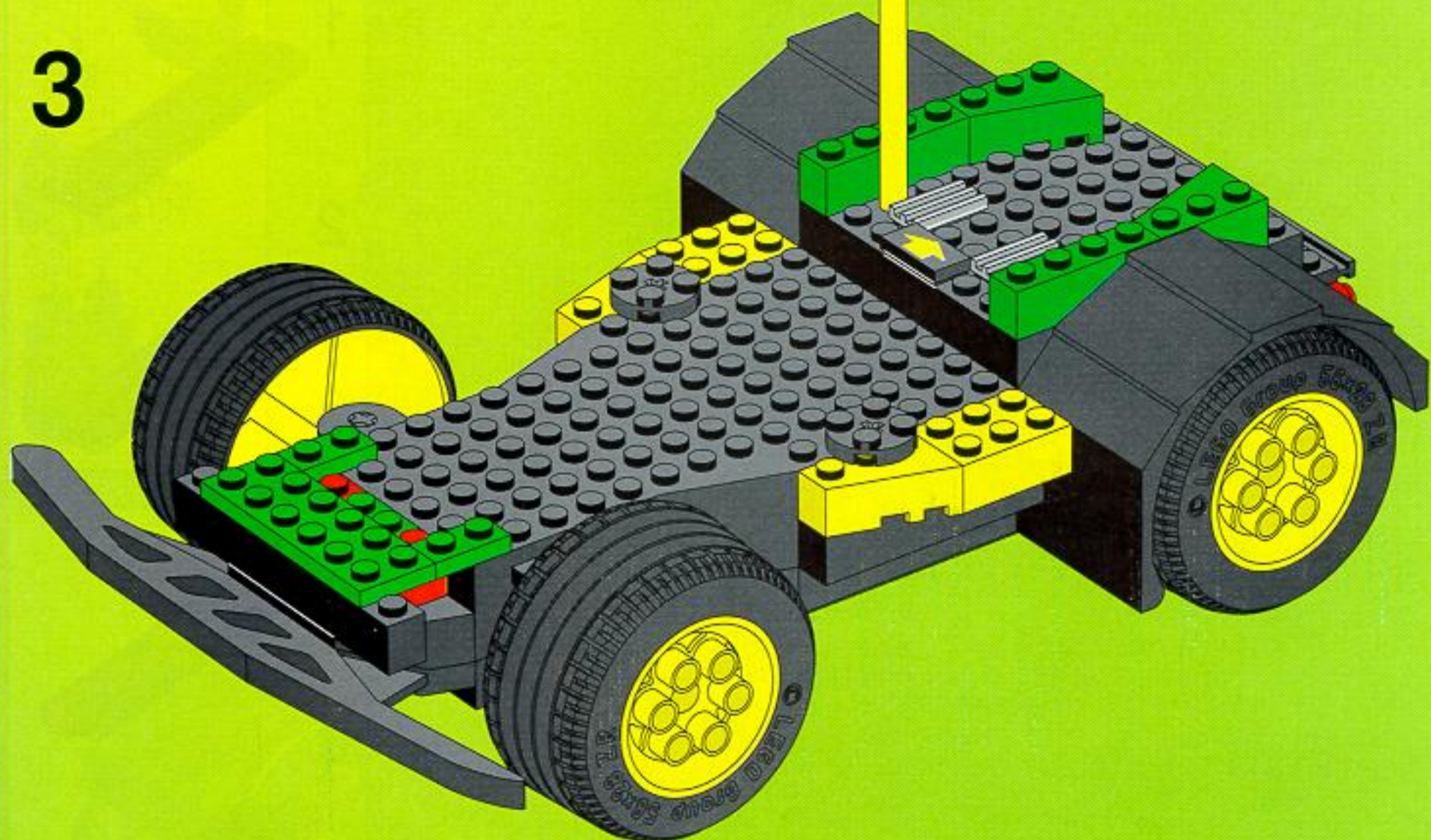

4



5

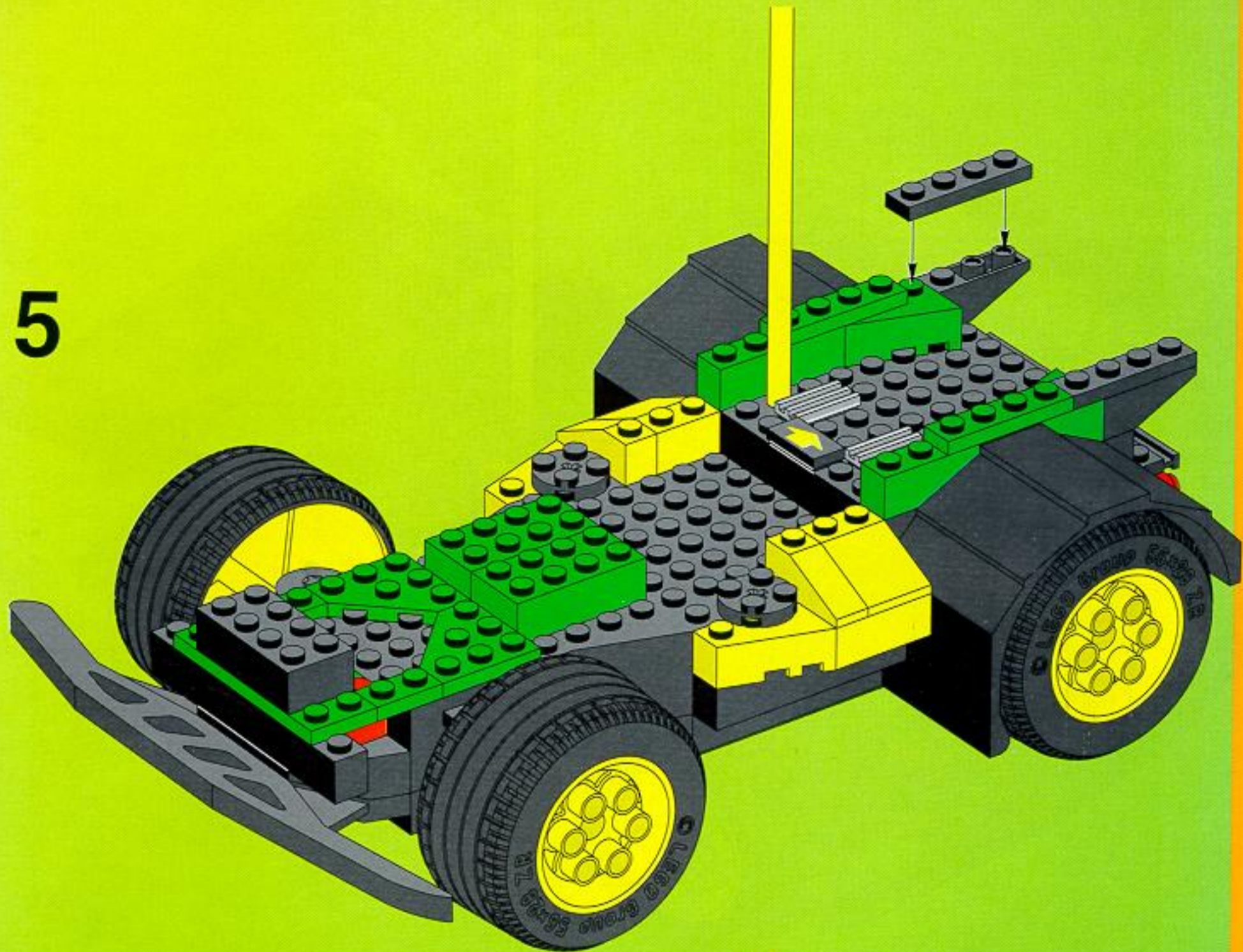

6



7

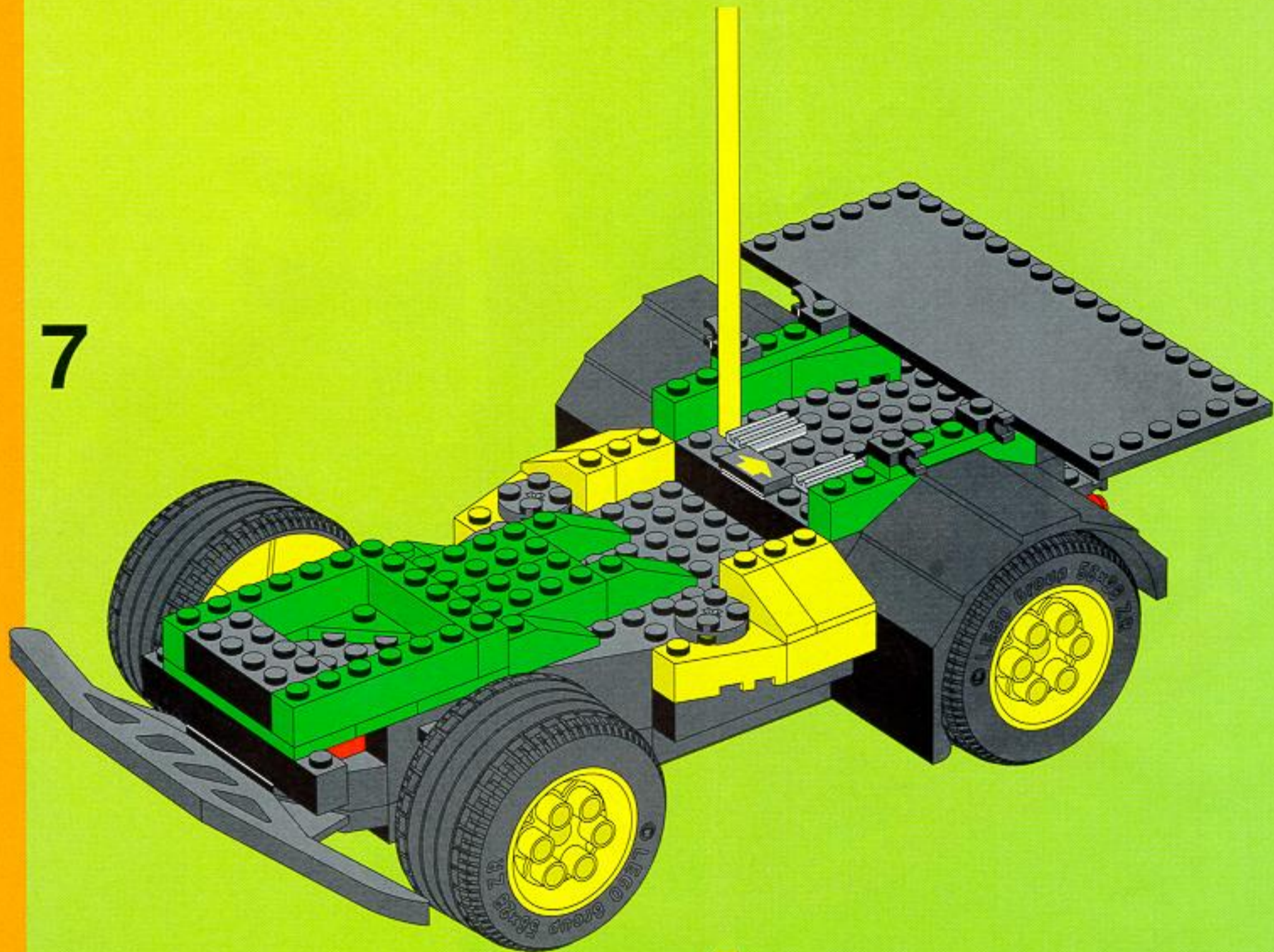

8

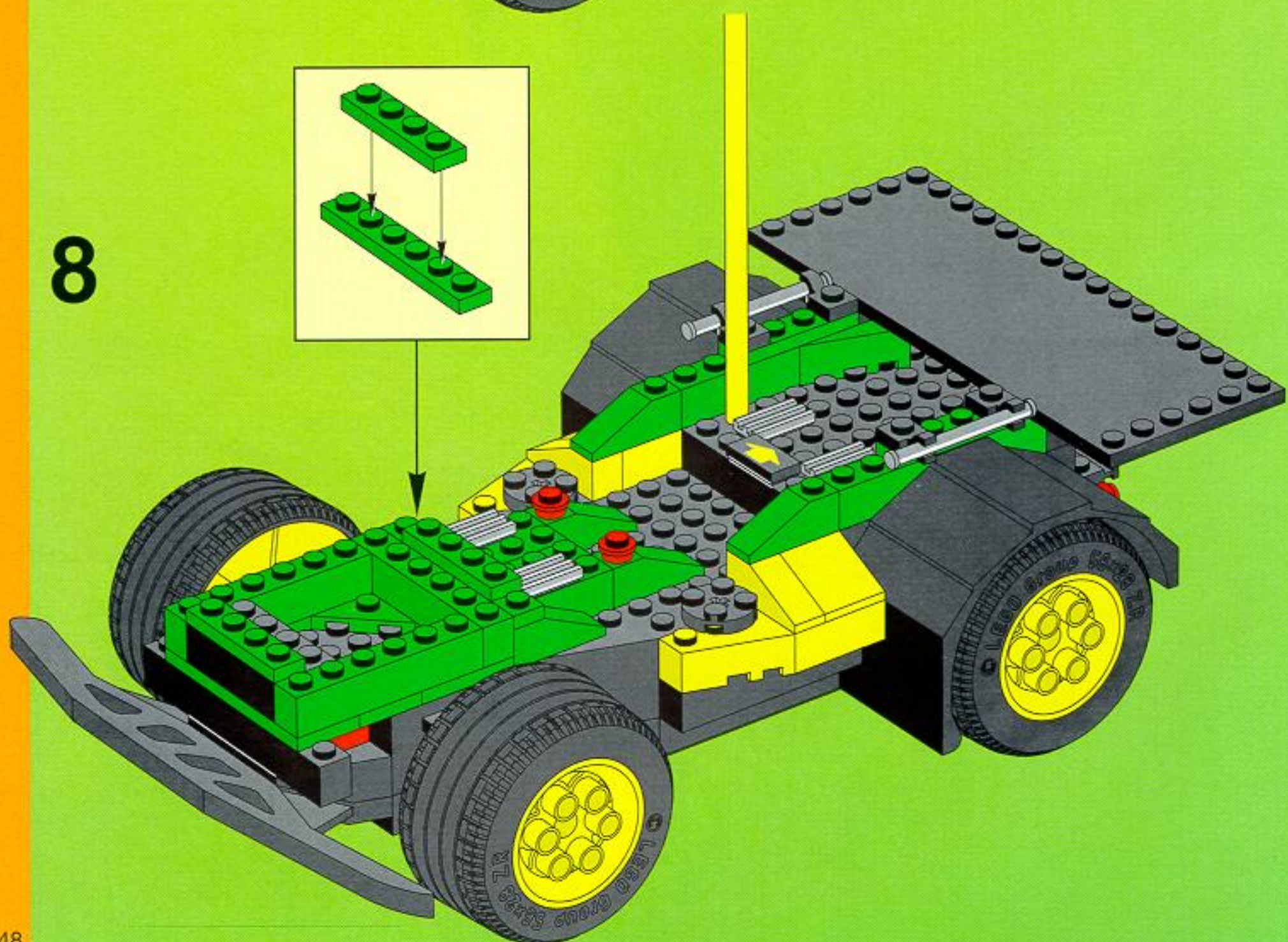
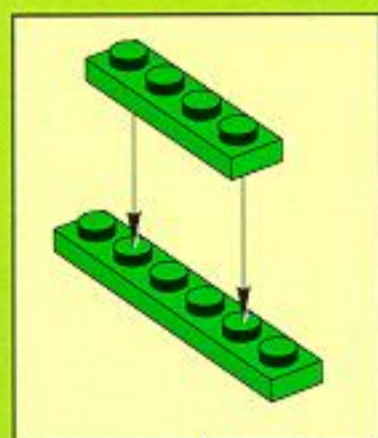

9

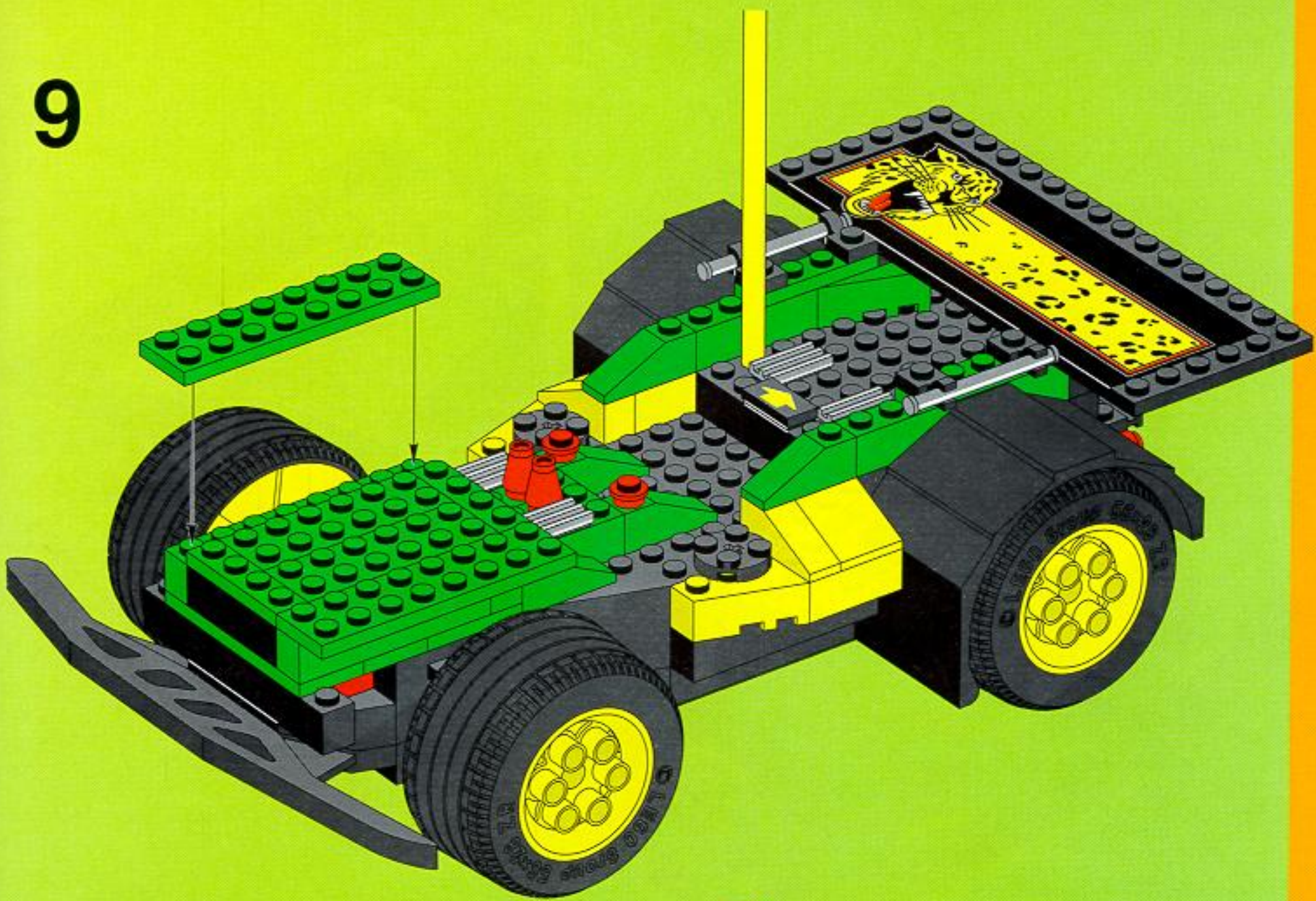

10

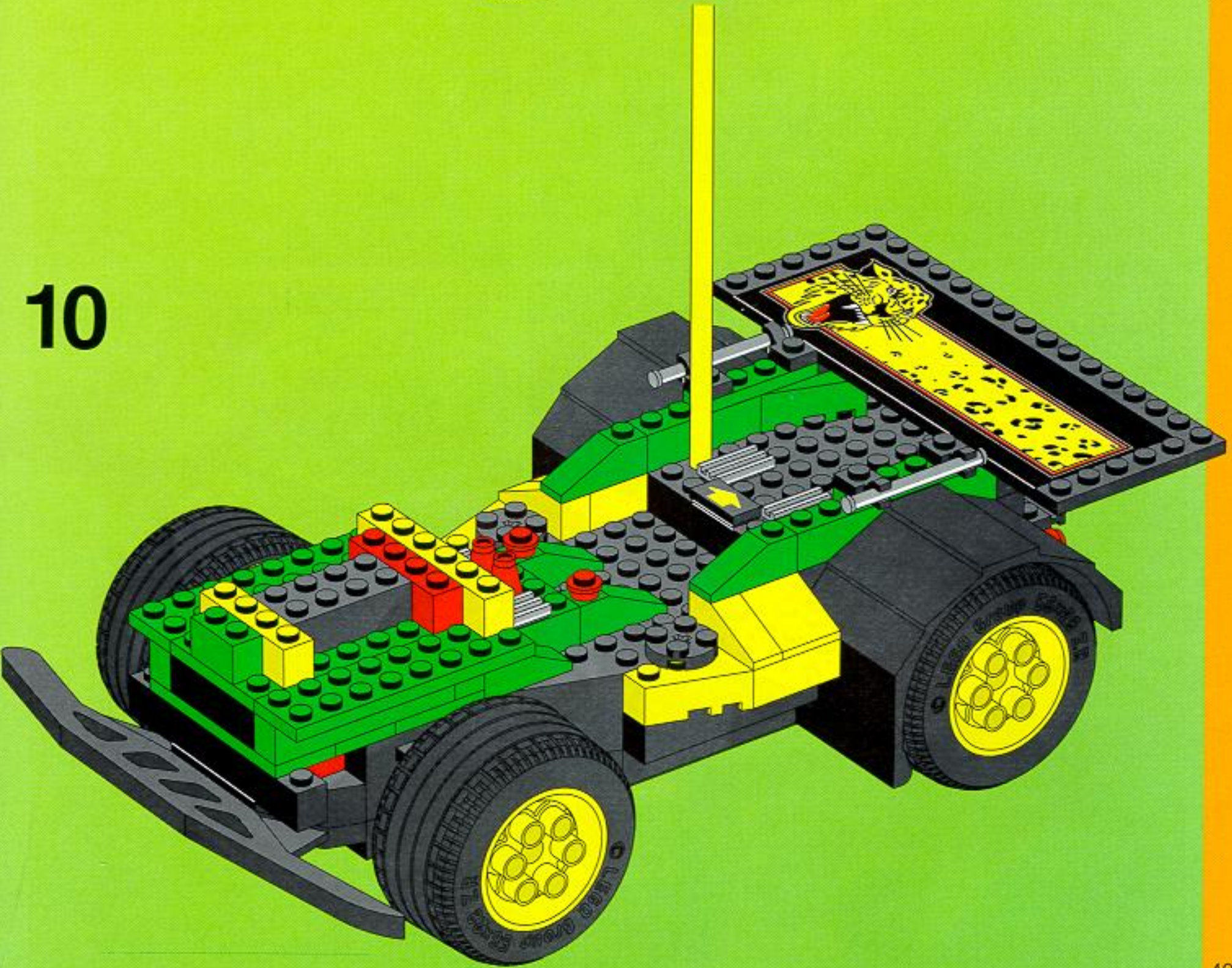

11

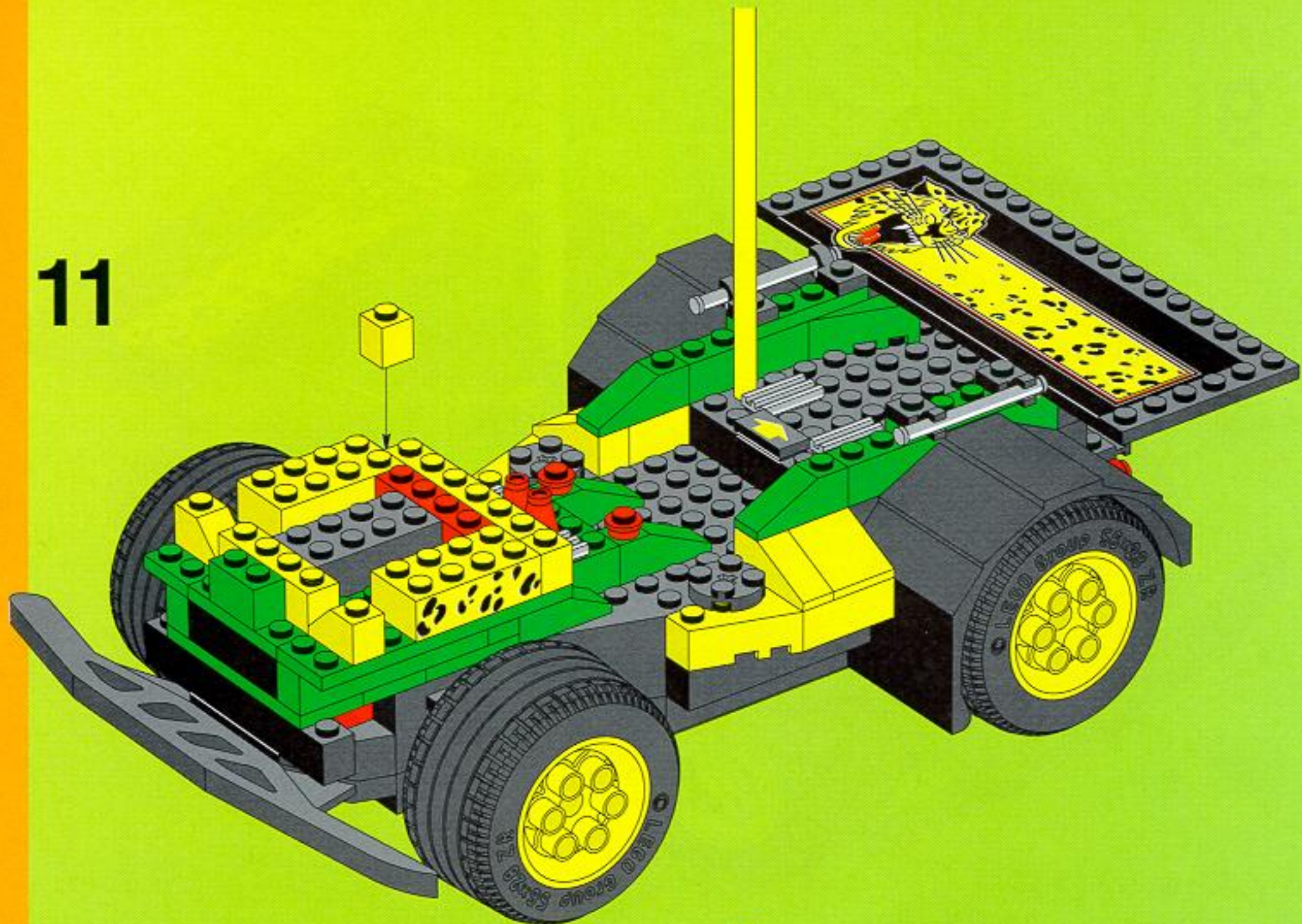

12

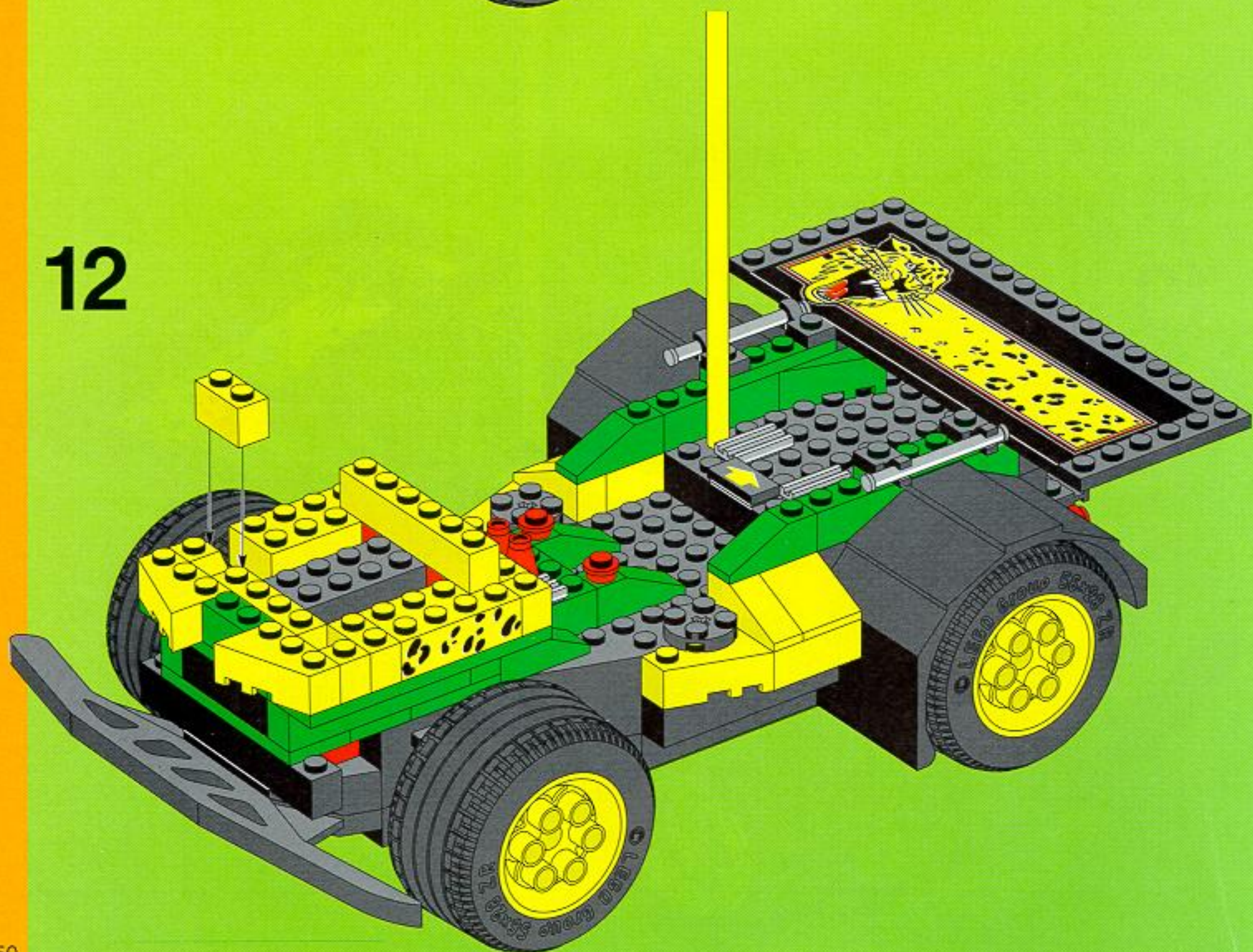

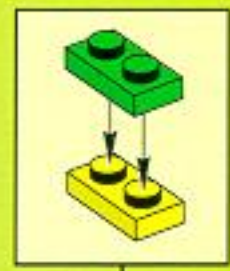

13

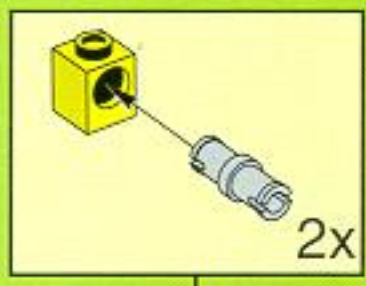

2x

14

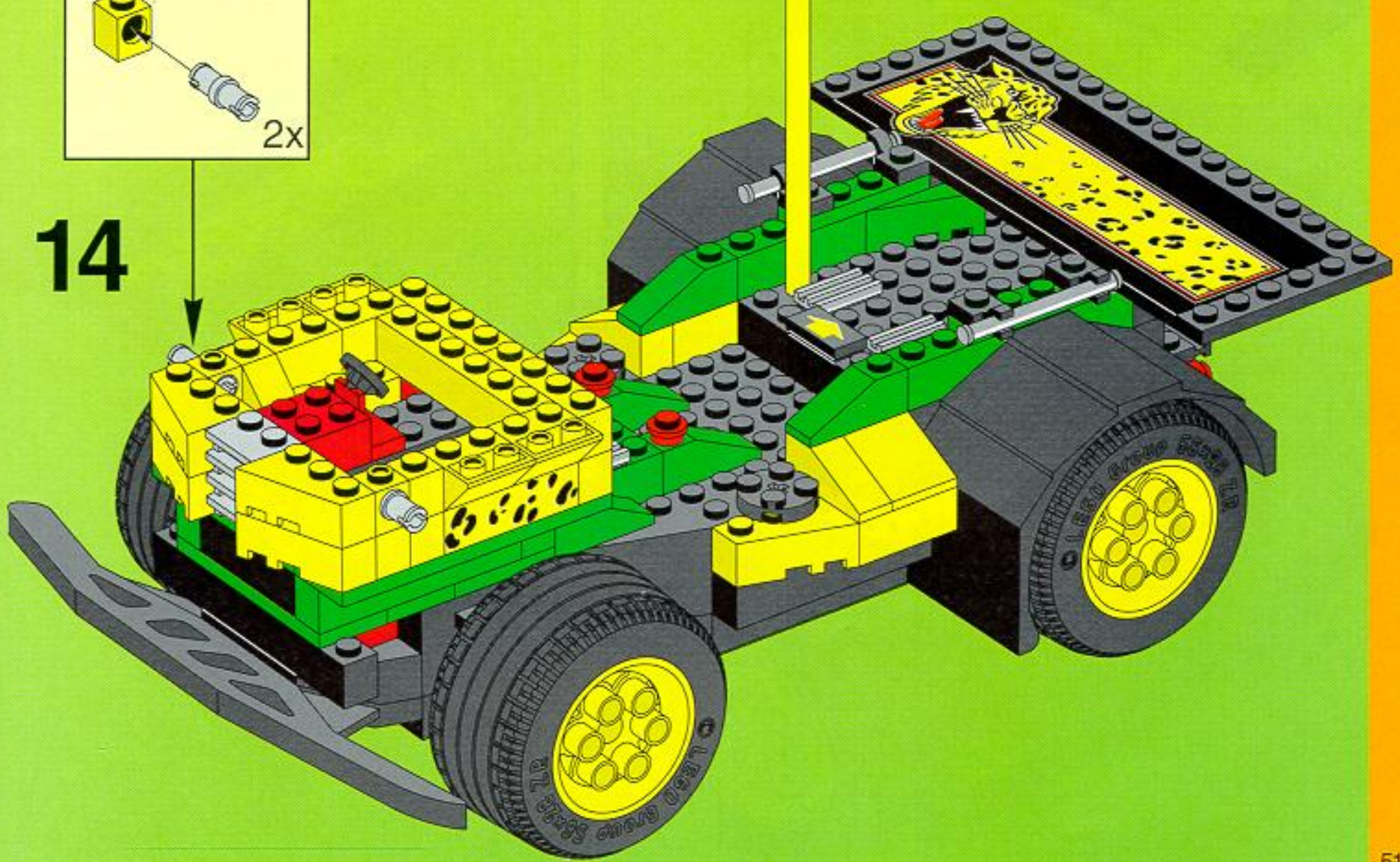

15

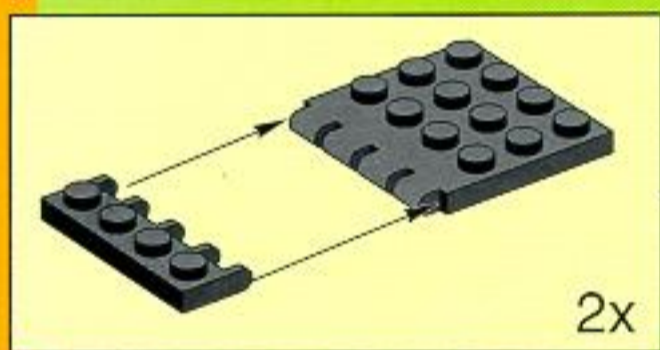
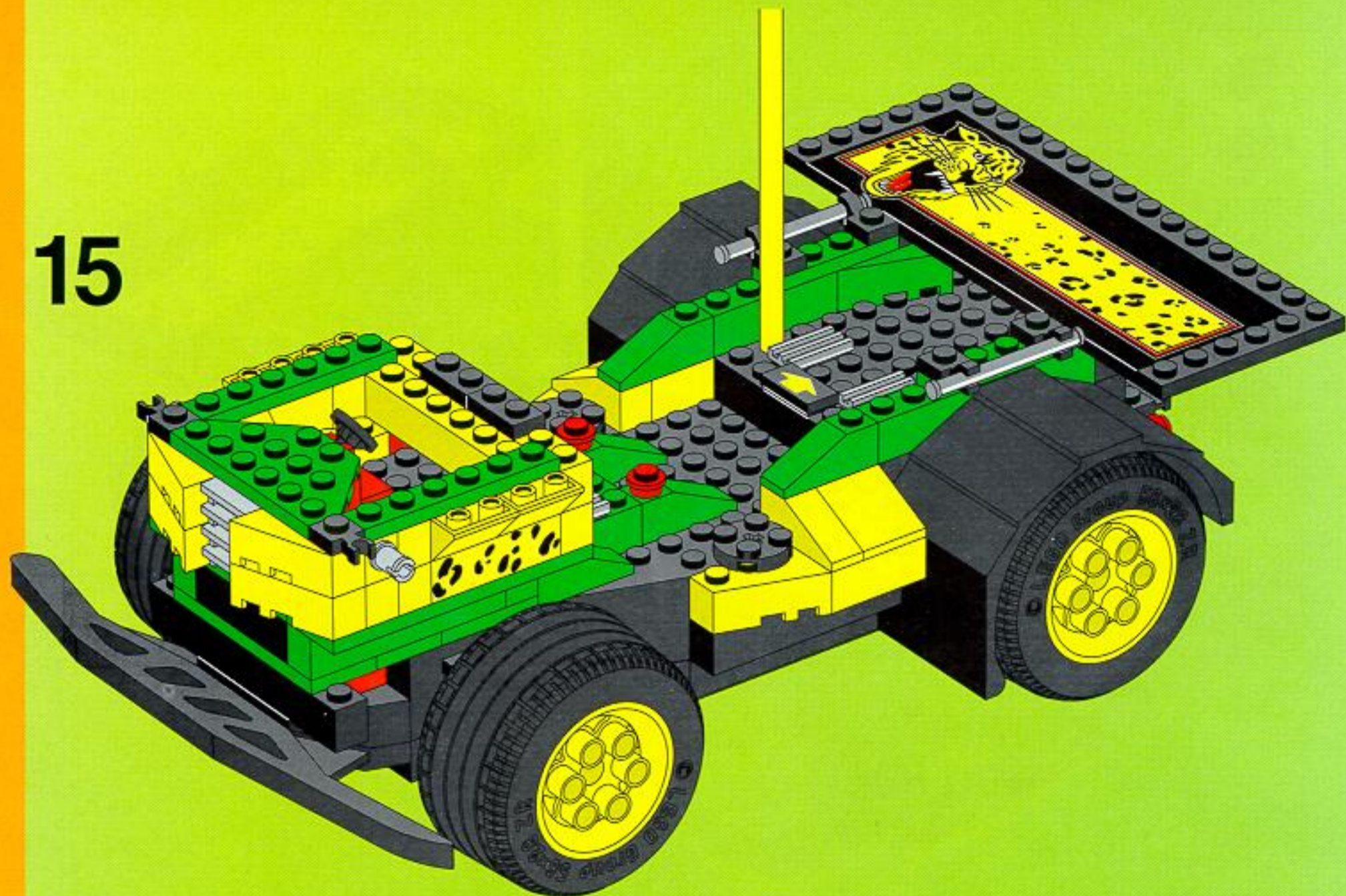

16

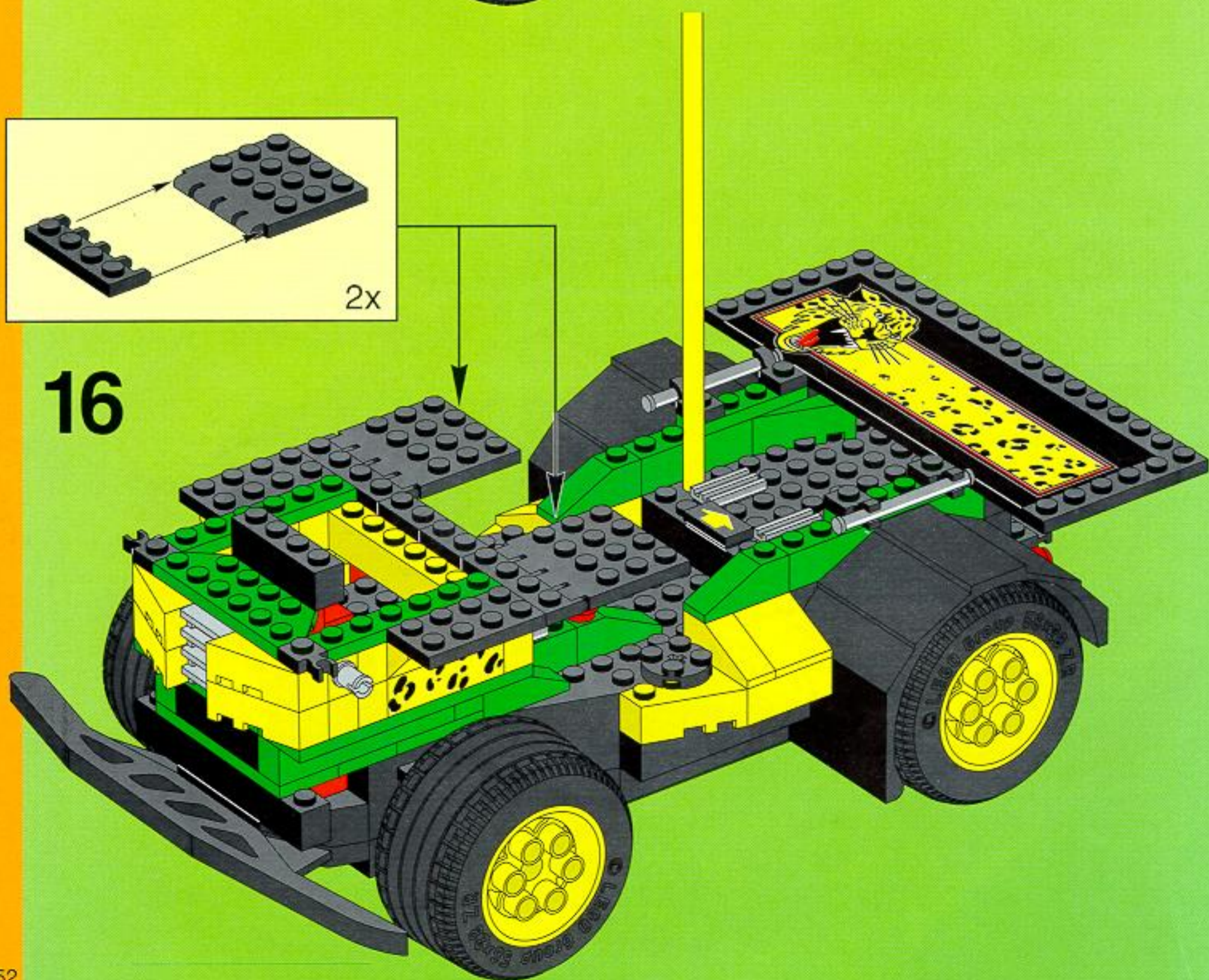

17

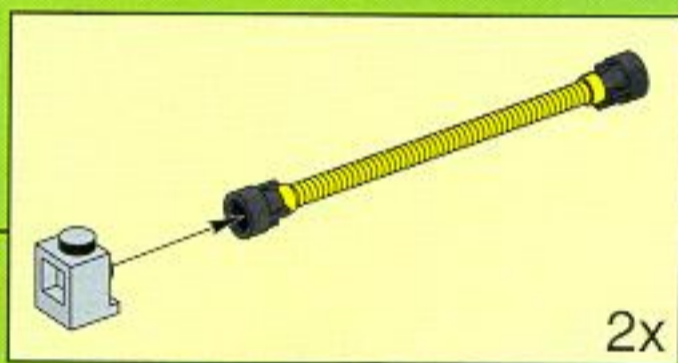

18

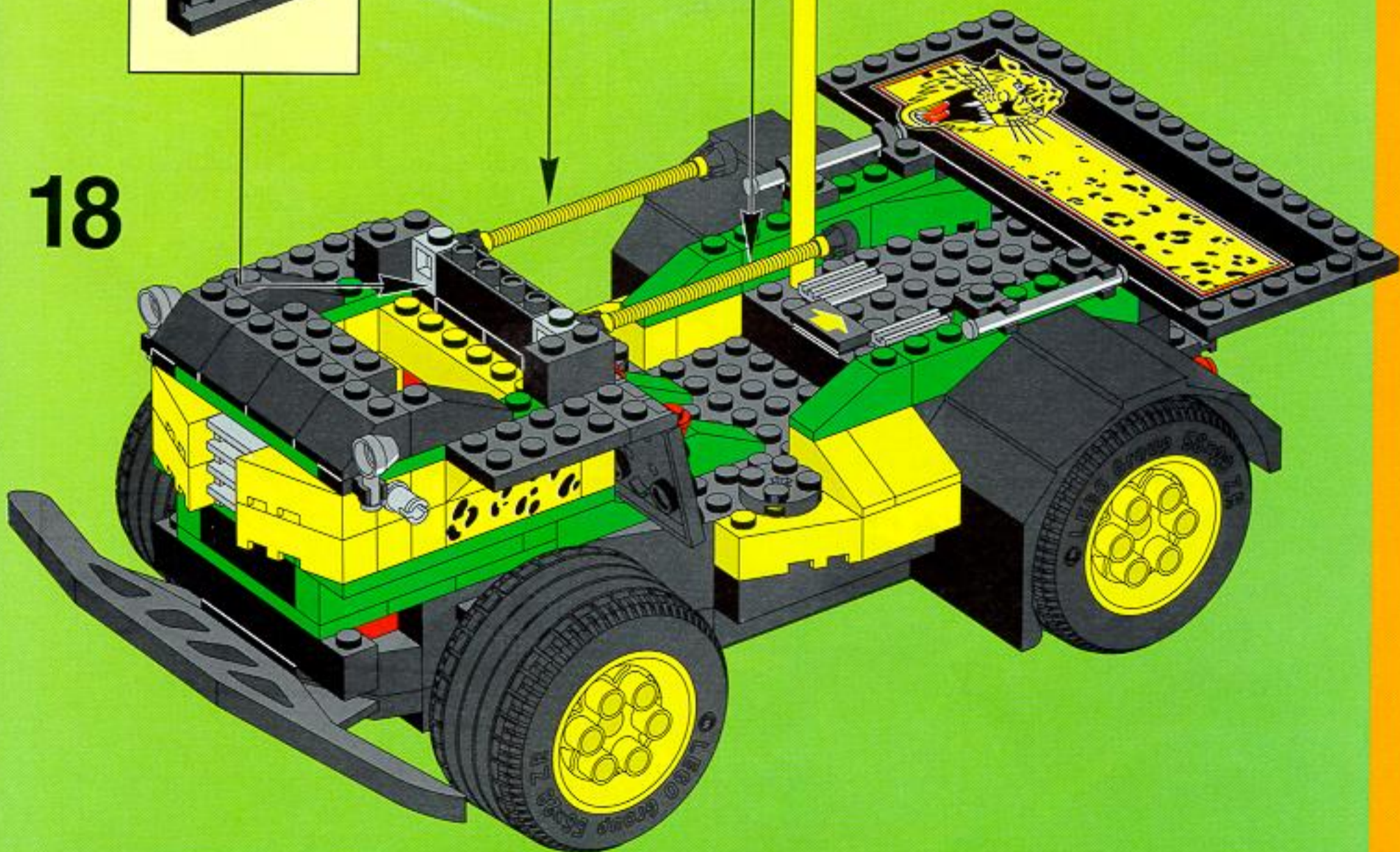

19

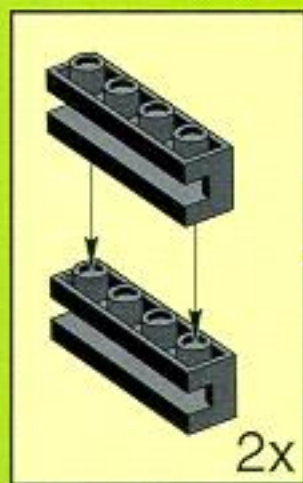

20

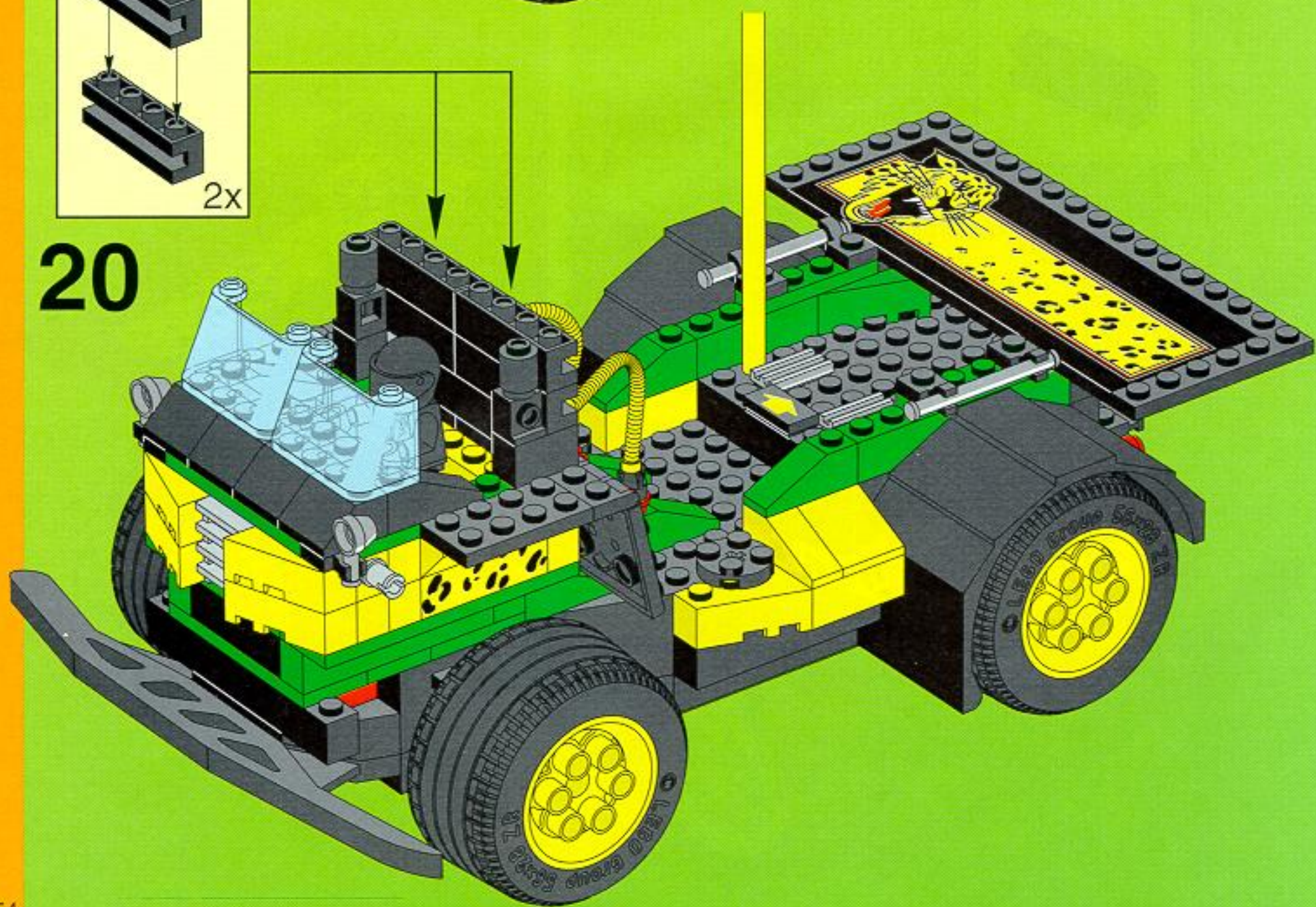

21

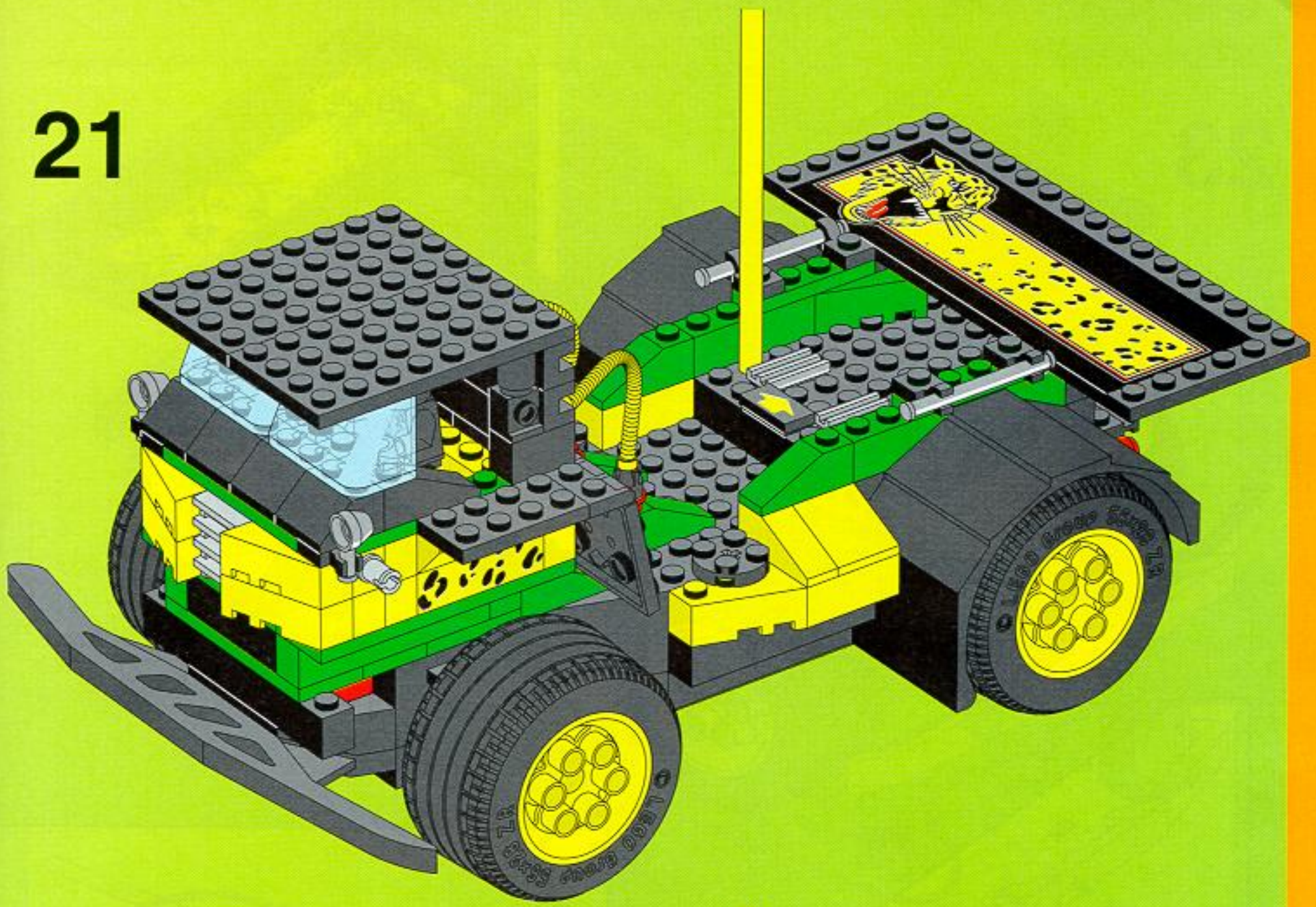

22



23

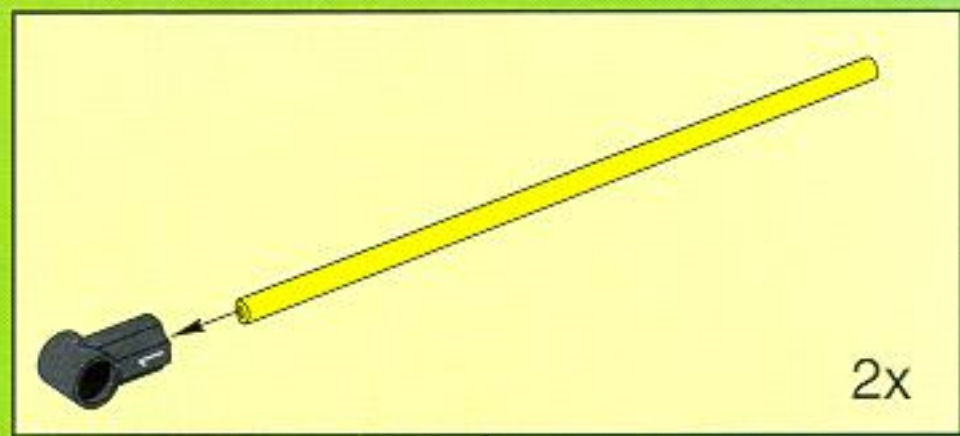
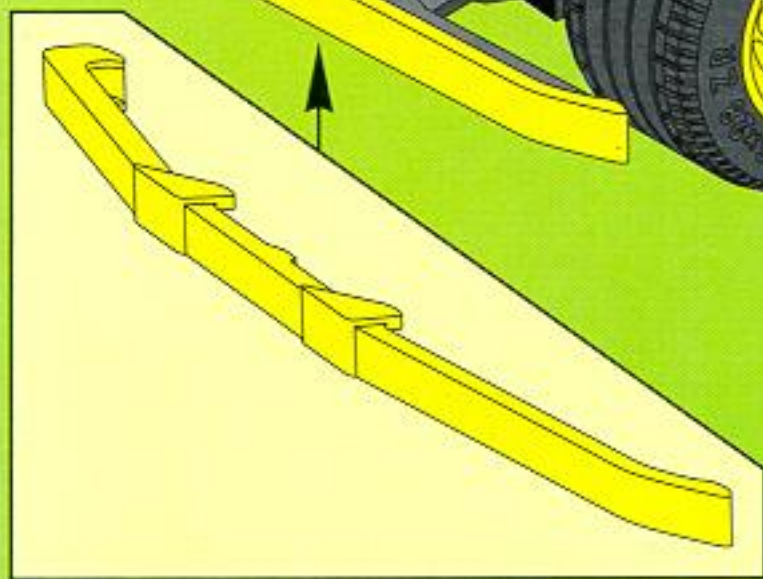

24

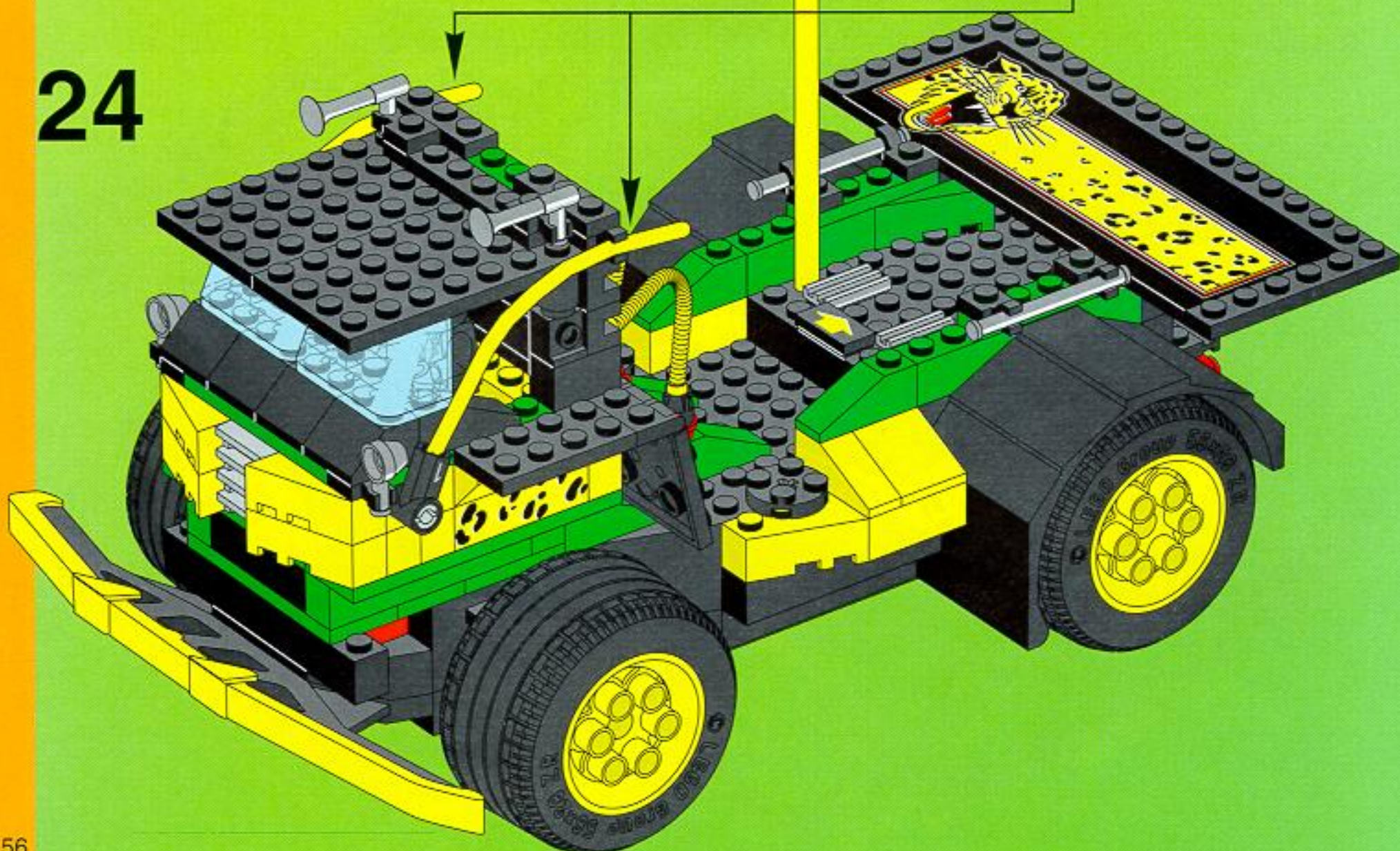

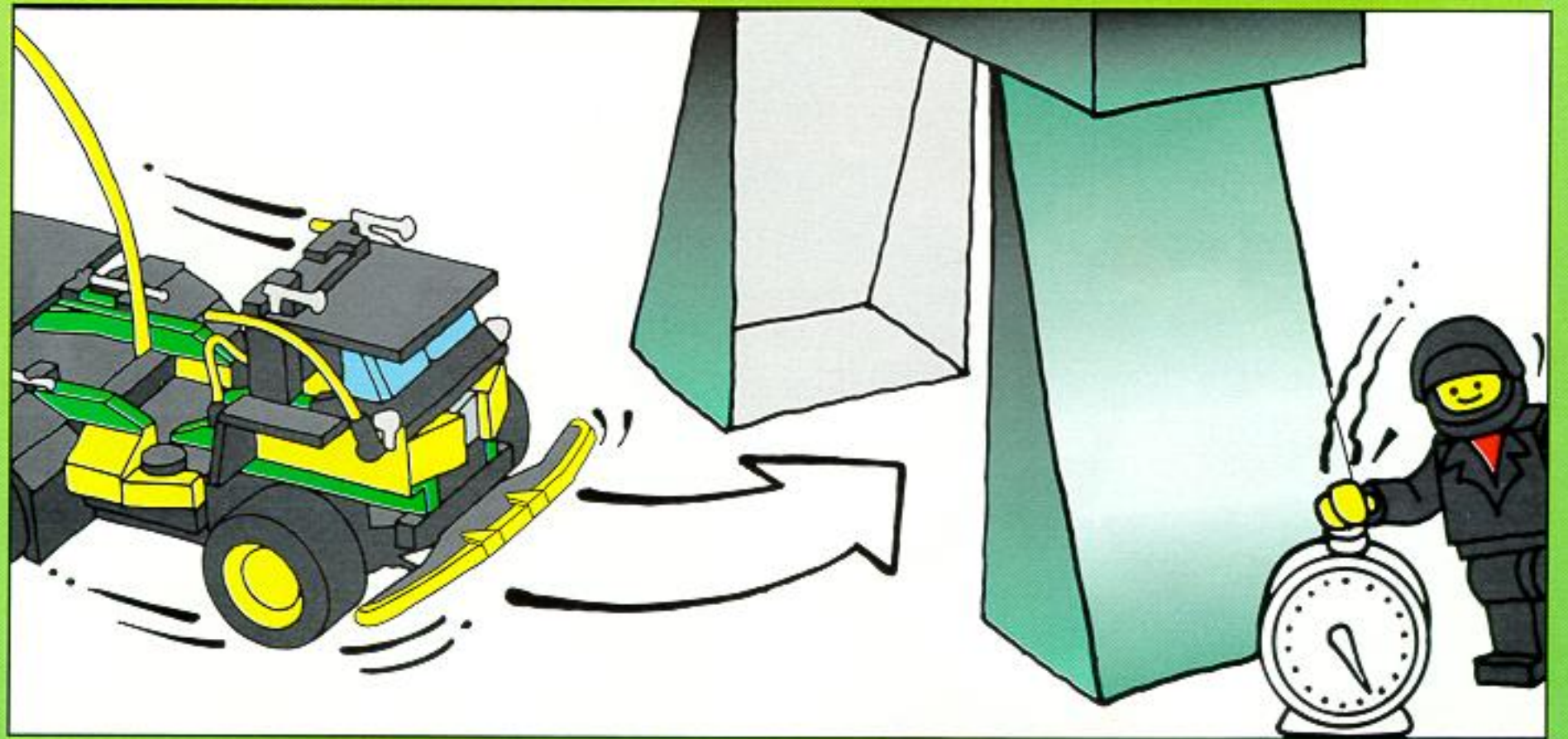
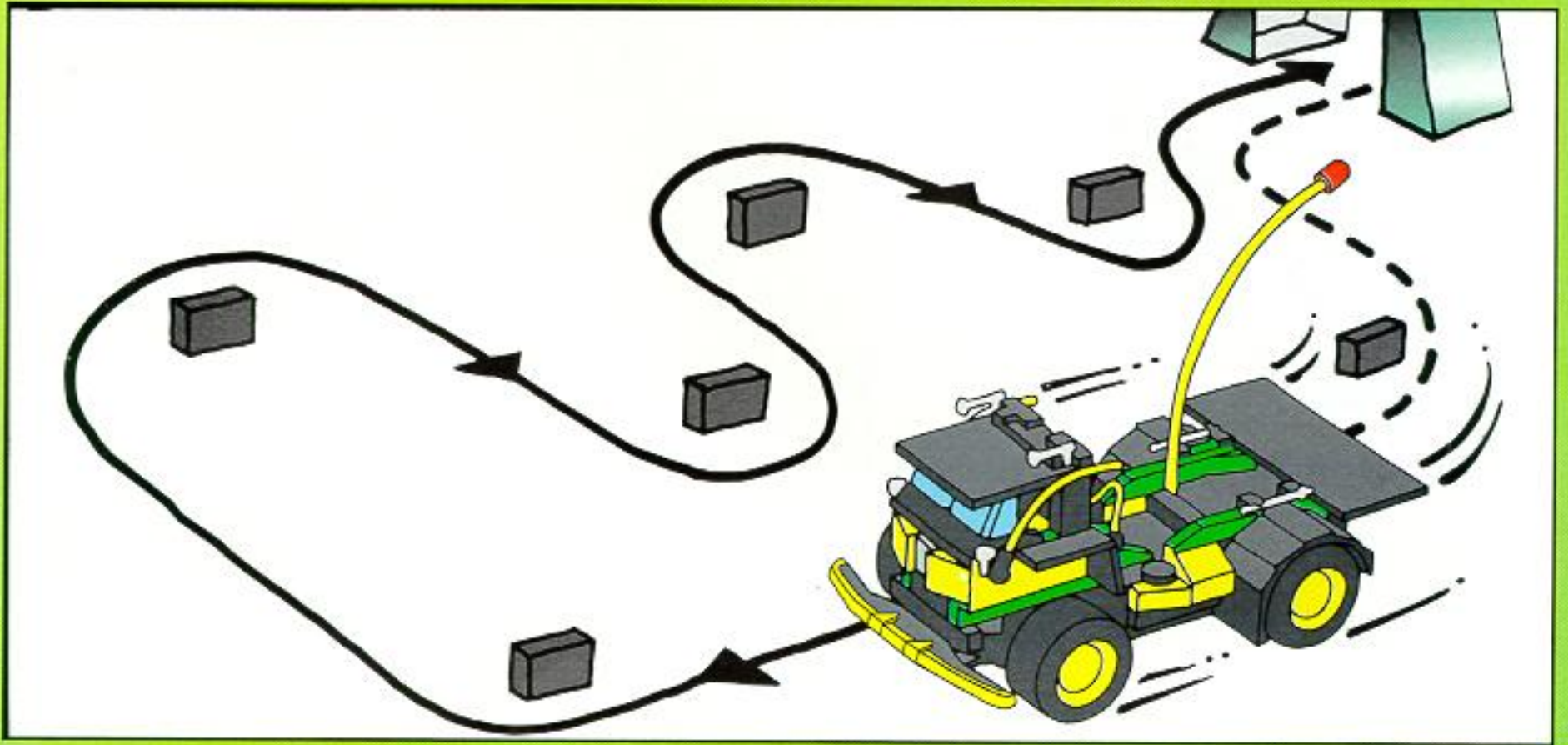

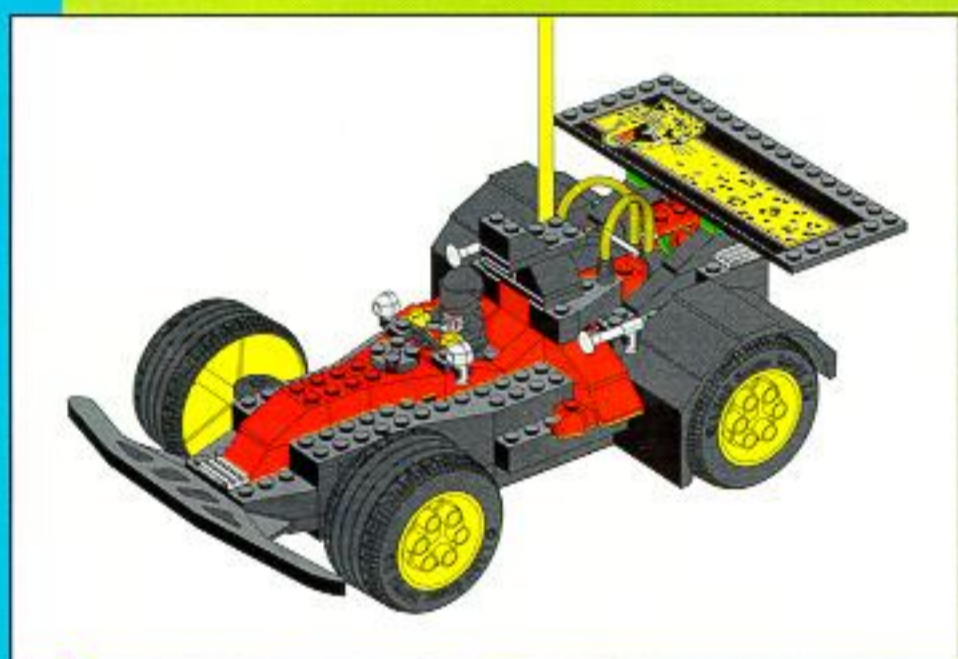
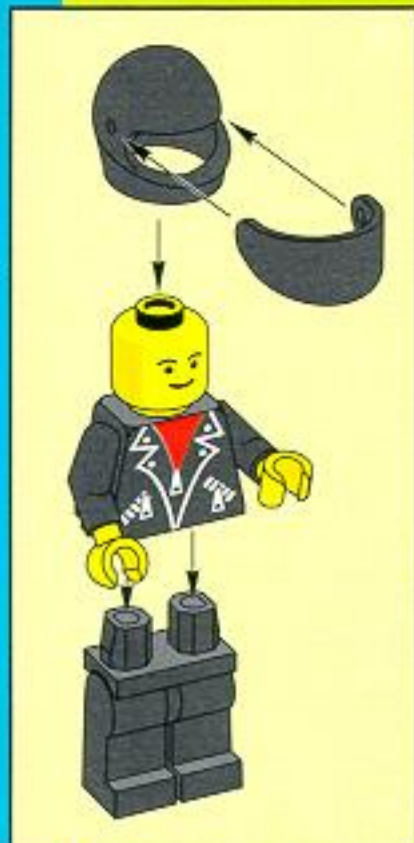

1

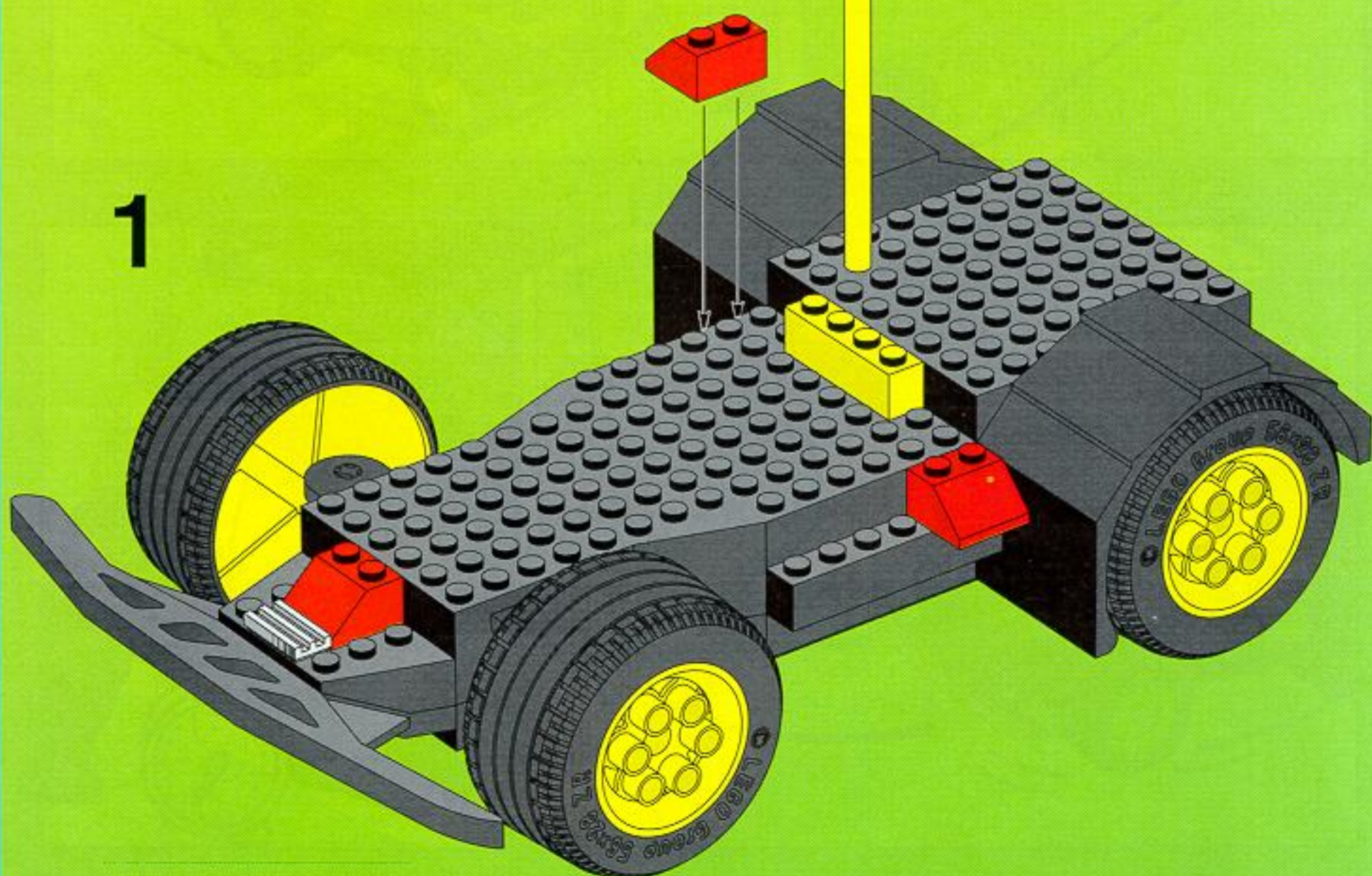

2

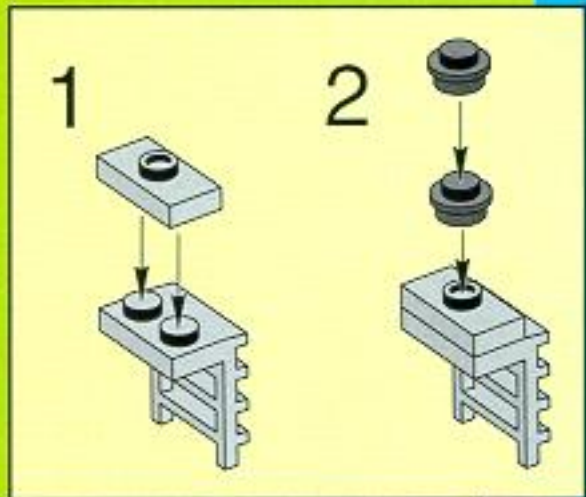
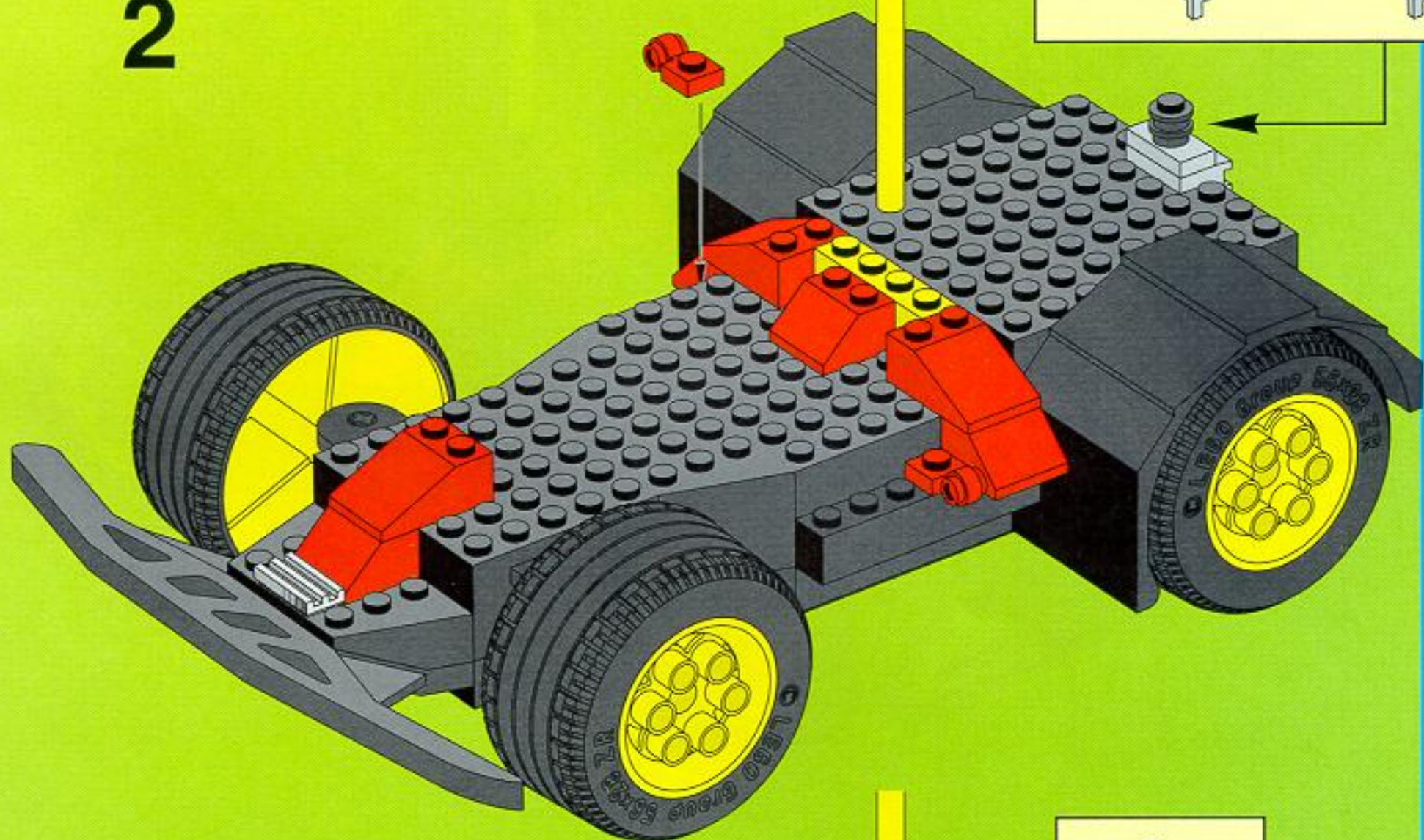

3

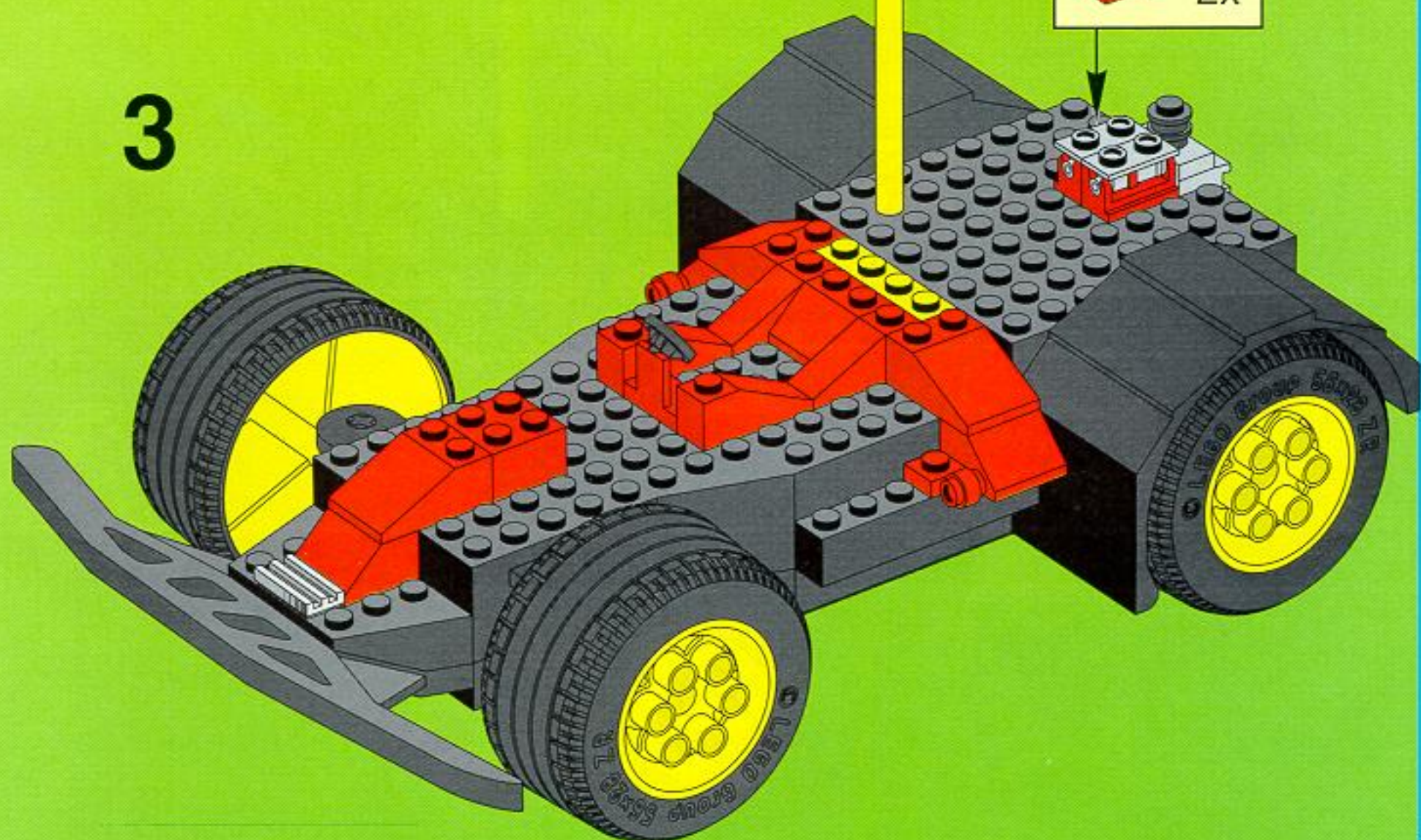

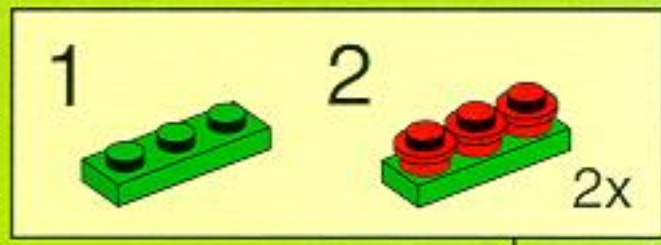

4

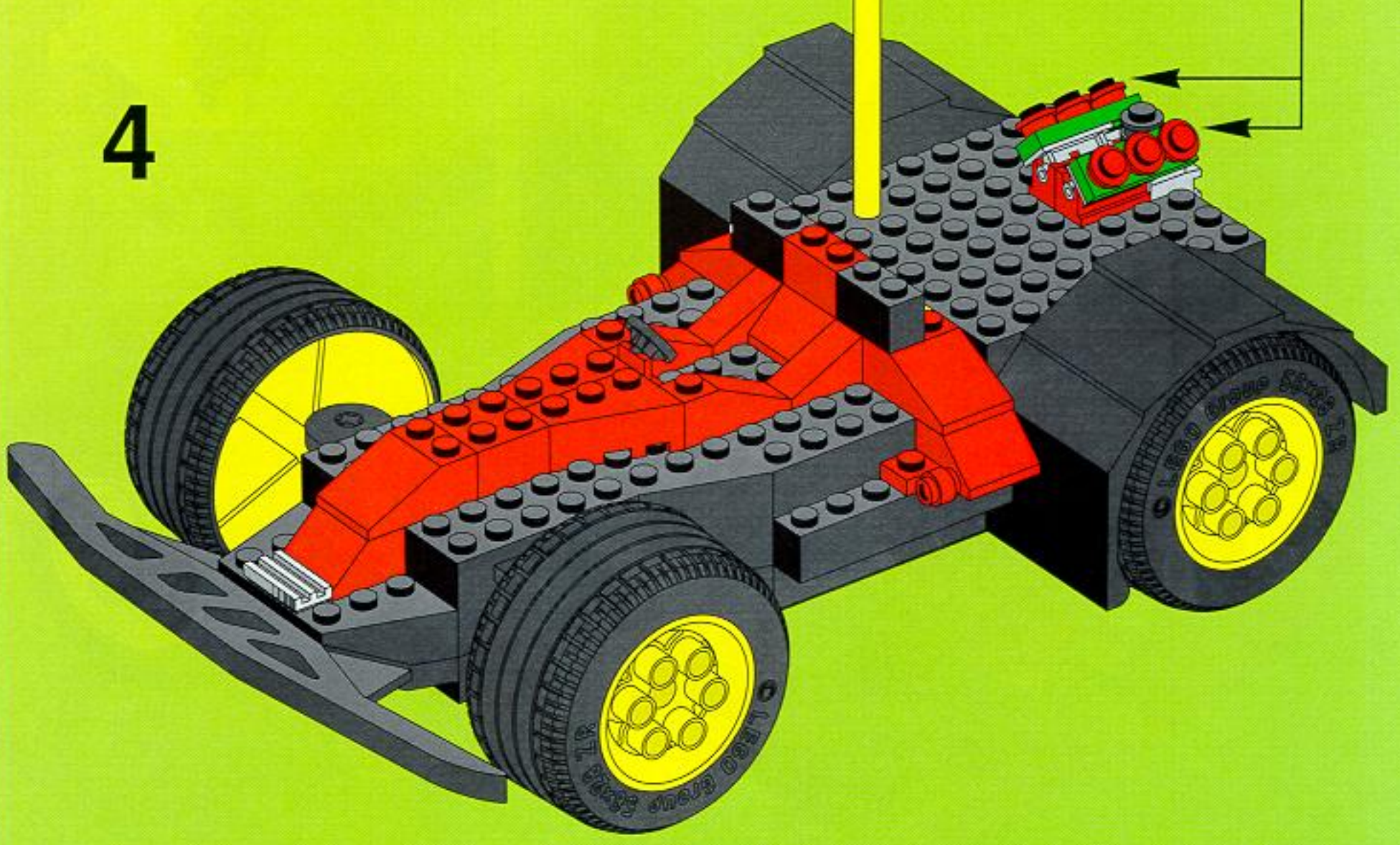

5

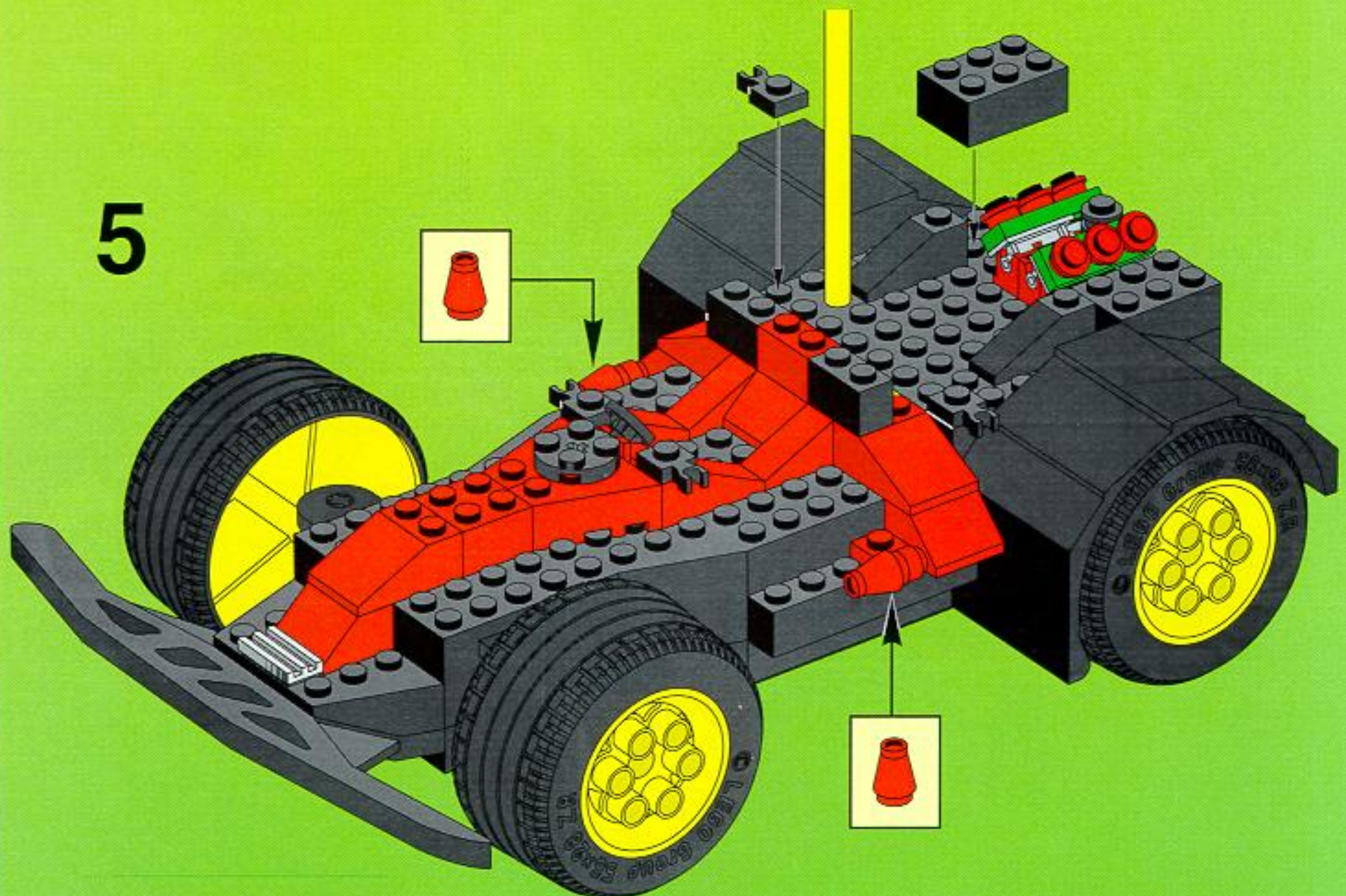

6

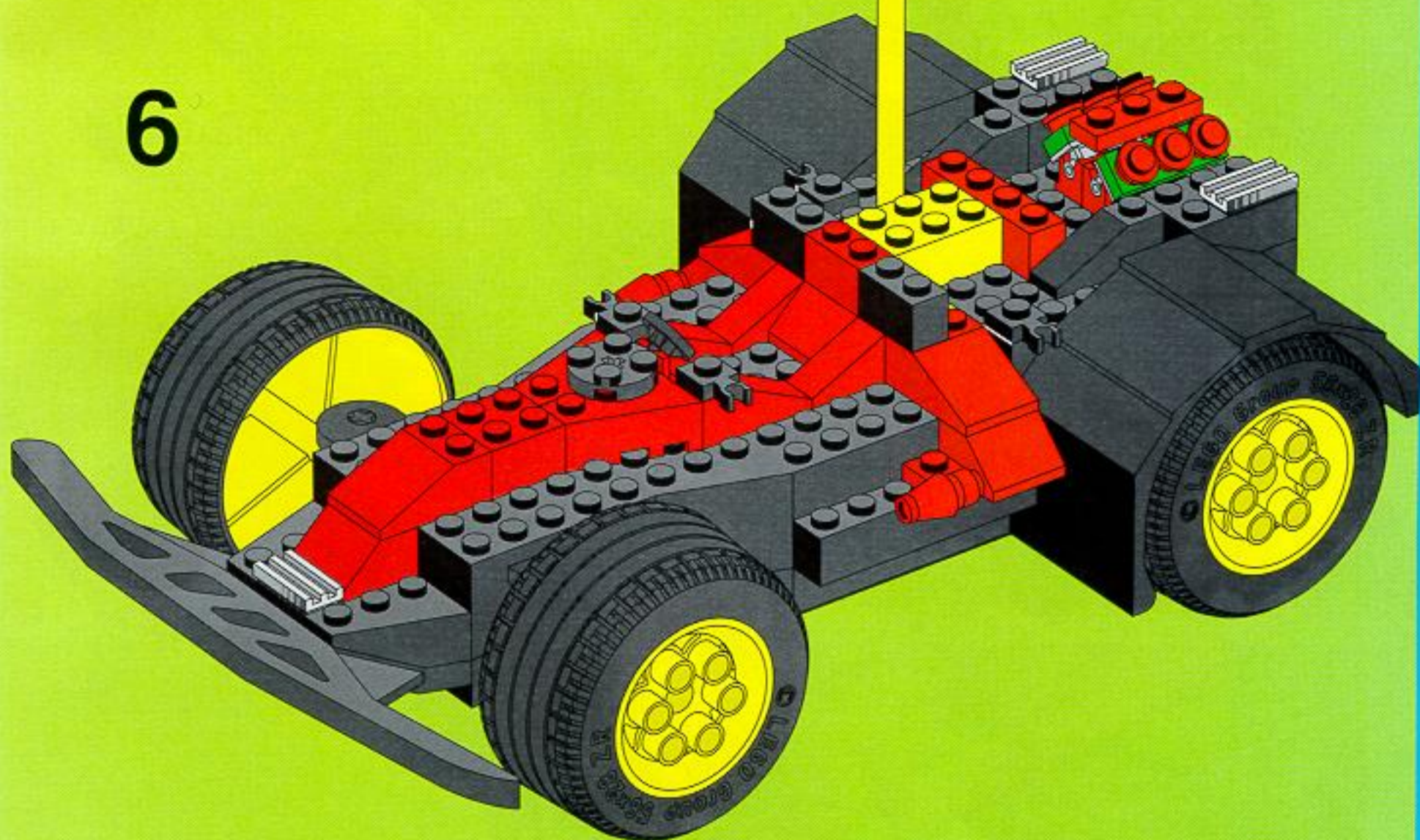

7

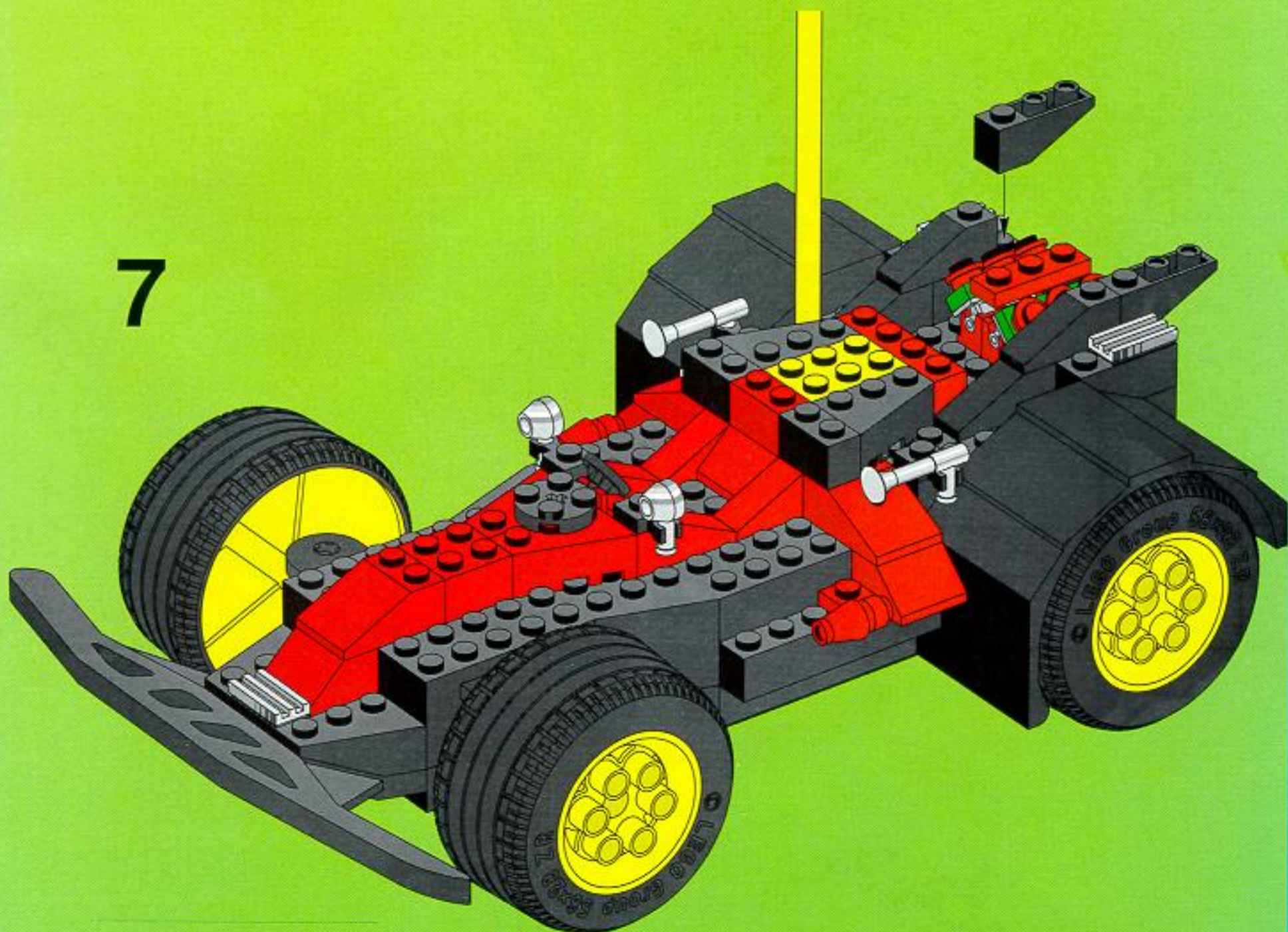

1

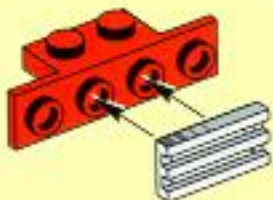

2



8

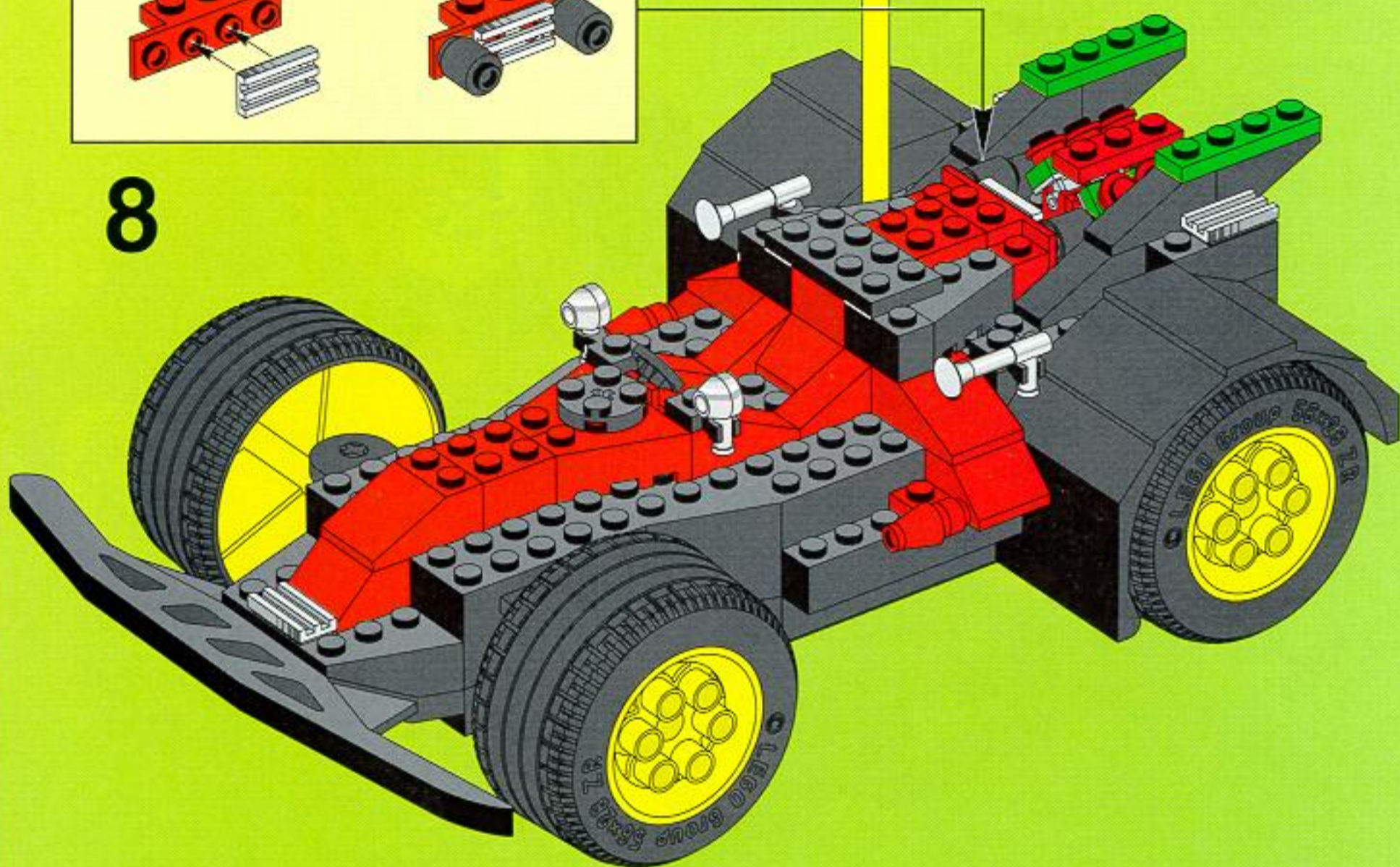

2x

9

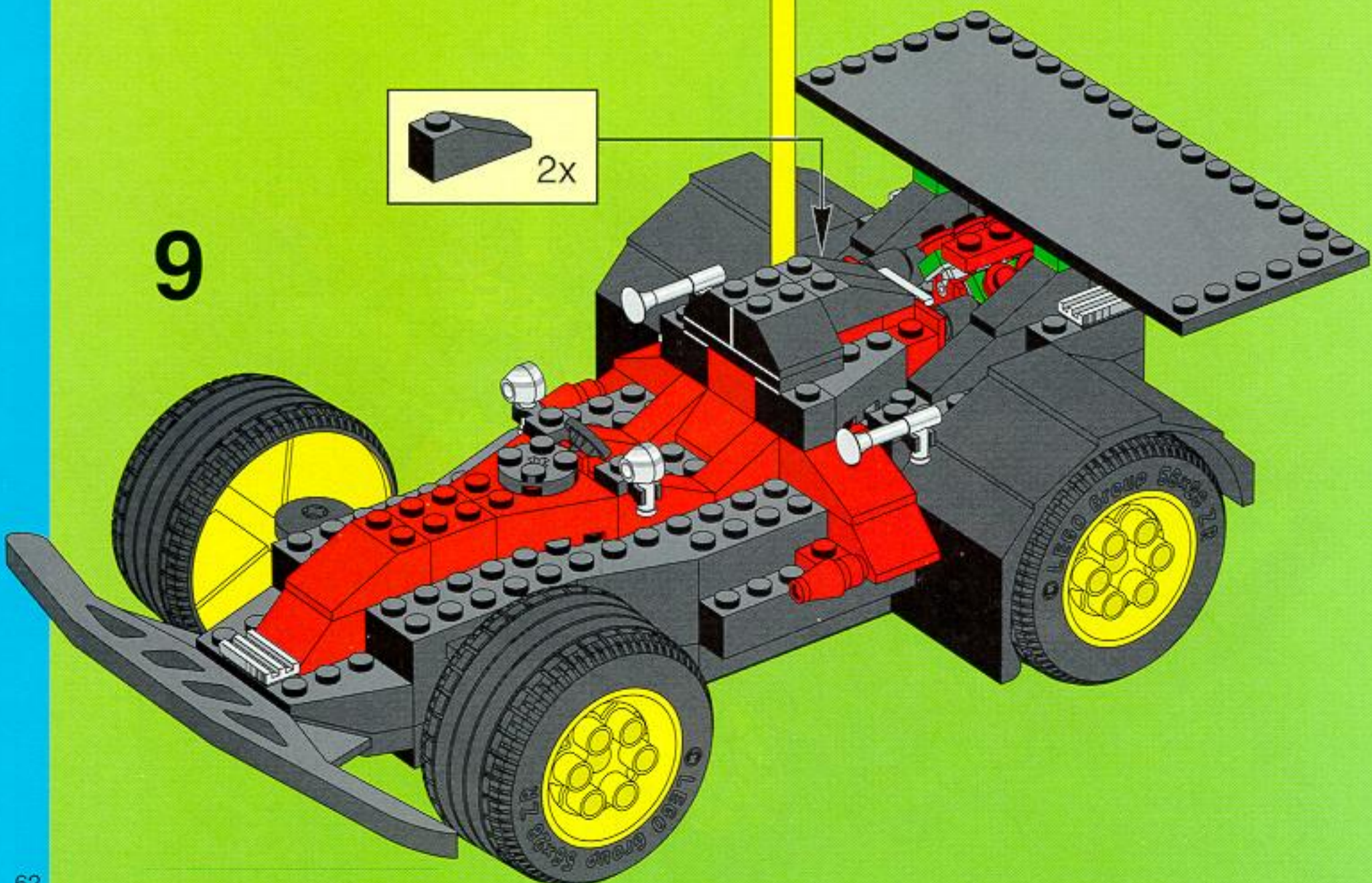

10

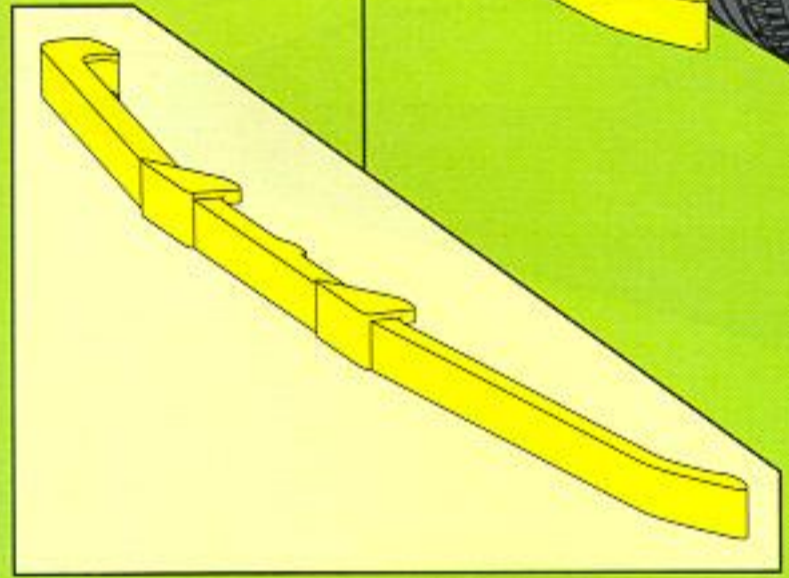
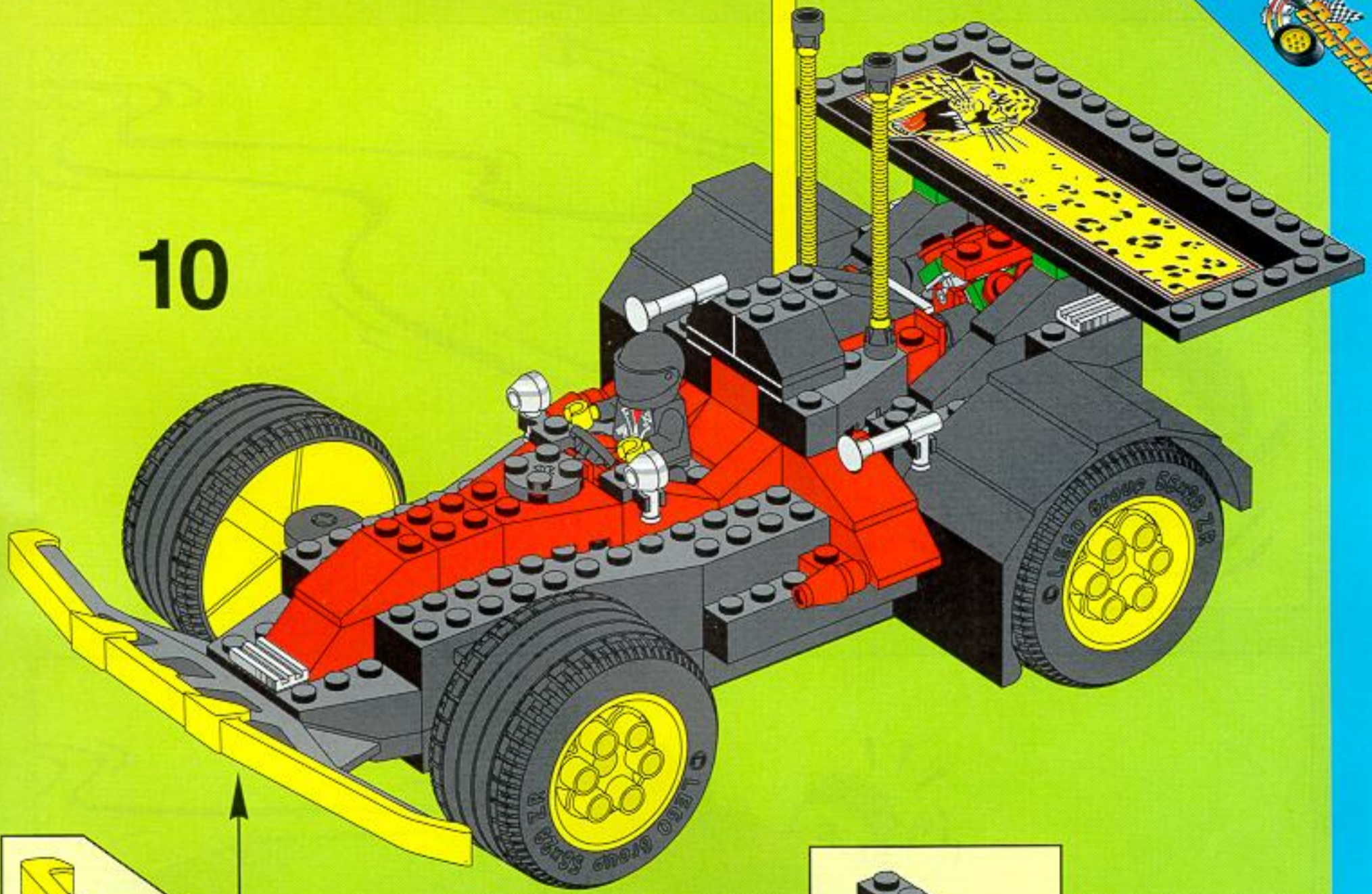

11

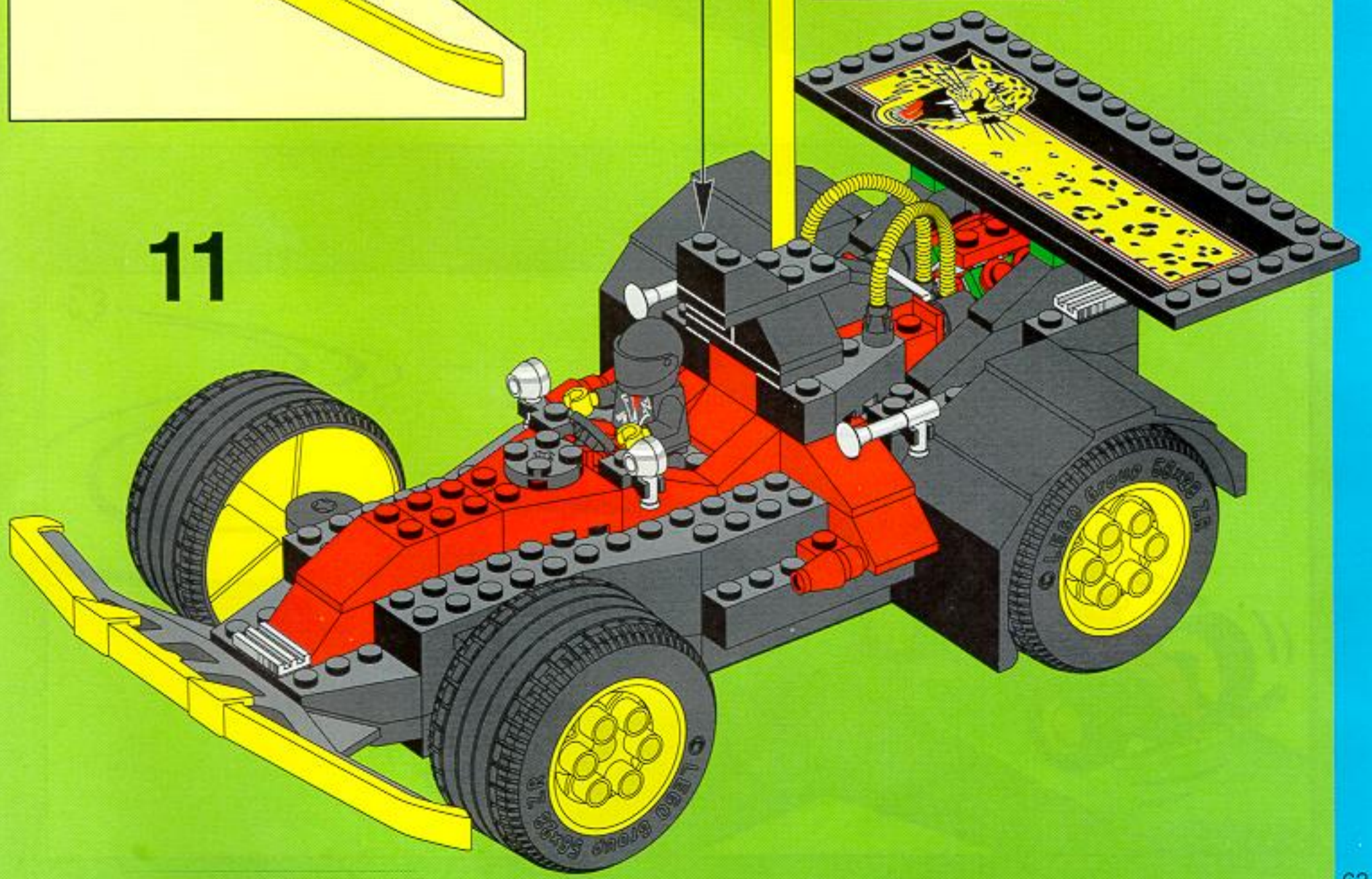

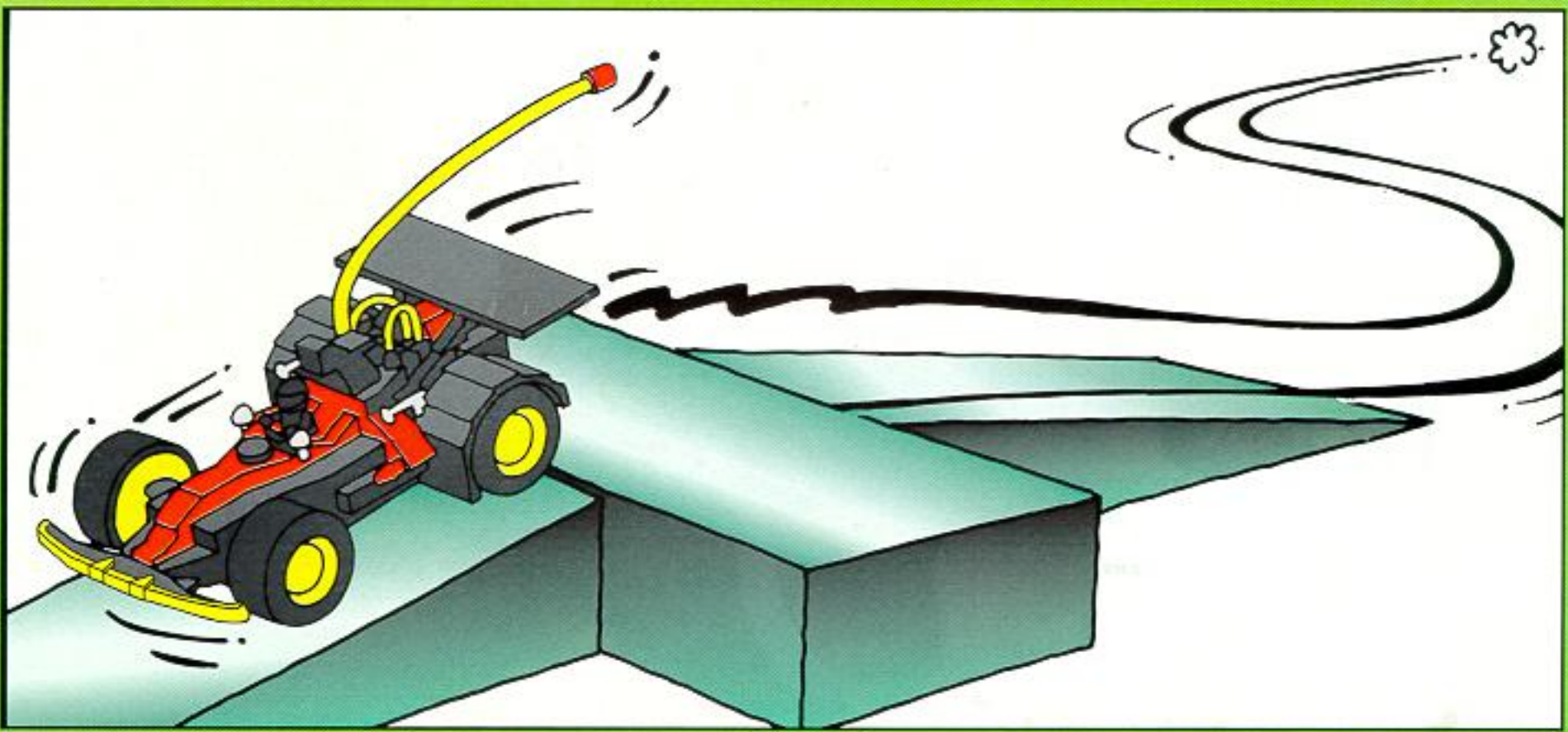
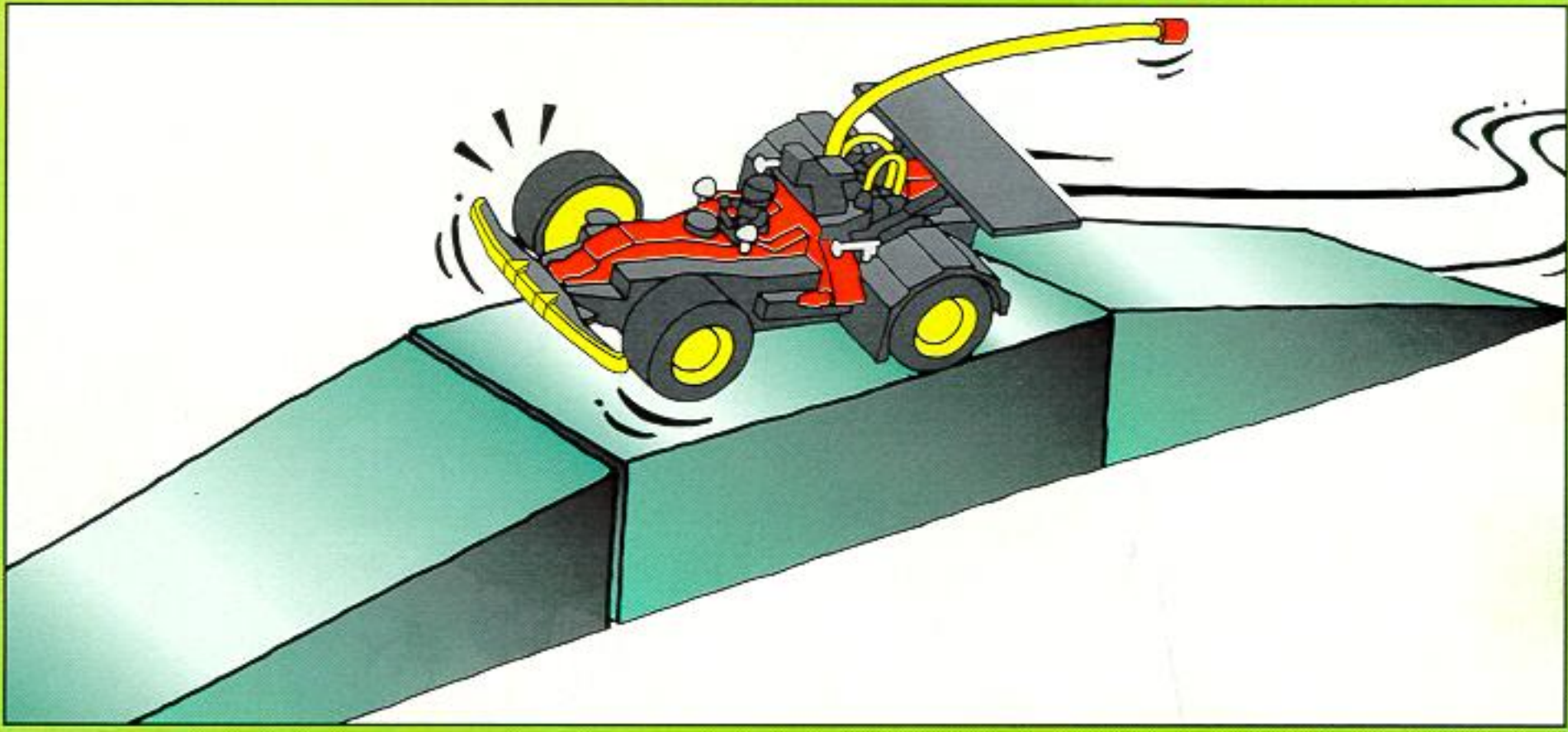
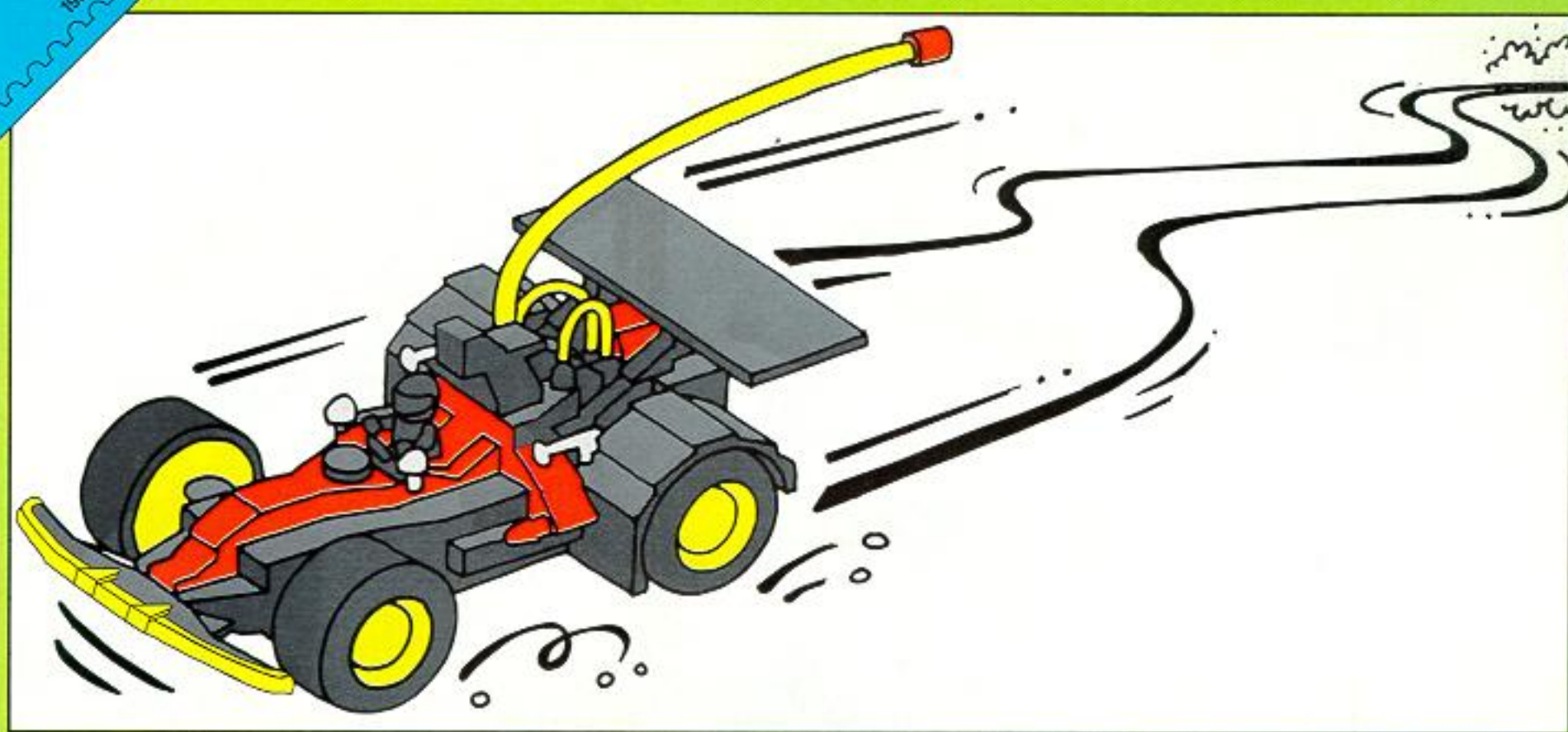

LEGO® SYSTEM R/C 5600

Handleiding

Wij danken je dat je het LEGO® SYSTEM Radio Control 5600 hebt gekocht. Je zult vele uren op een creatieve en interessante manier met het product kunnen spelen, als je er goed op past. In deze handleiding adviseren we je over de behandeling van het product – met name over de auto en de afstandsbediening. Lees de handleiding en bewaar hem zodat je 'm eventueel later nog eens kunt nalezen. Vergeet niet de goede adviezen op te volgen die worden gegeven.

- *Complete bedieningsfunctie*
- *2 versnellingen*
- *In te stellen regeling*
- *Bumper*

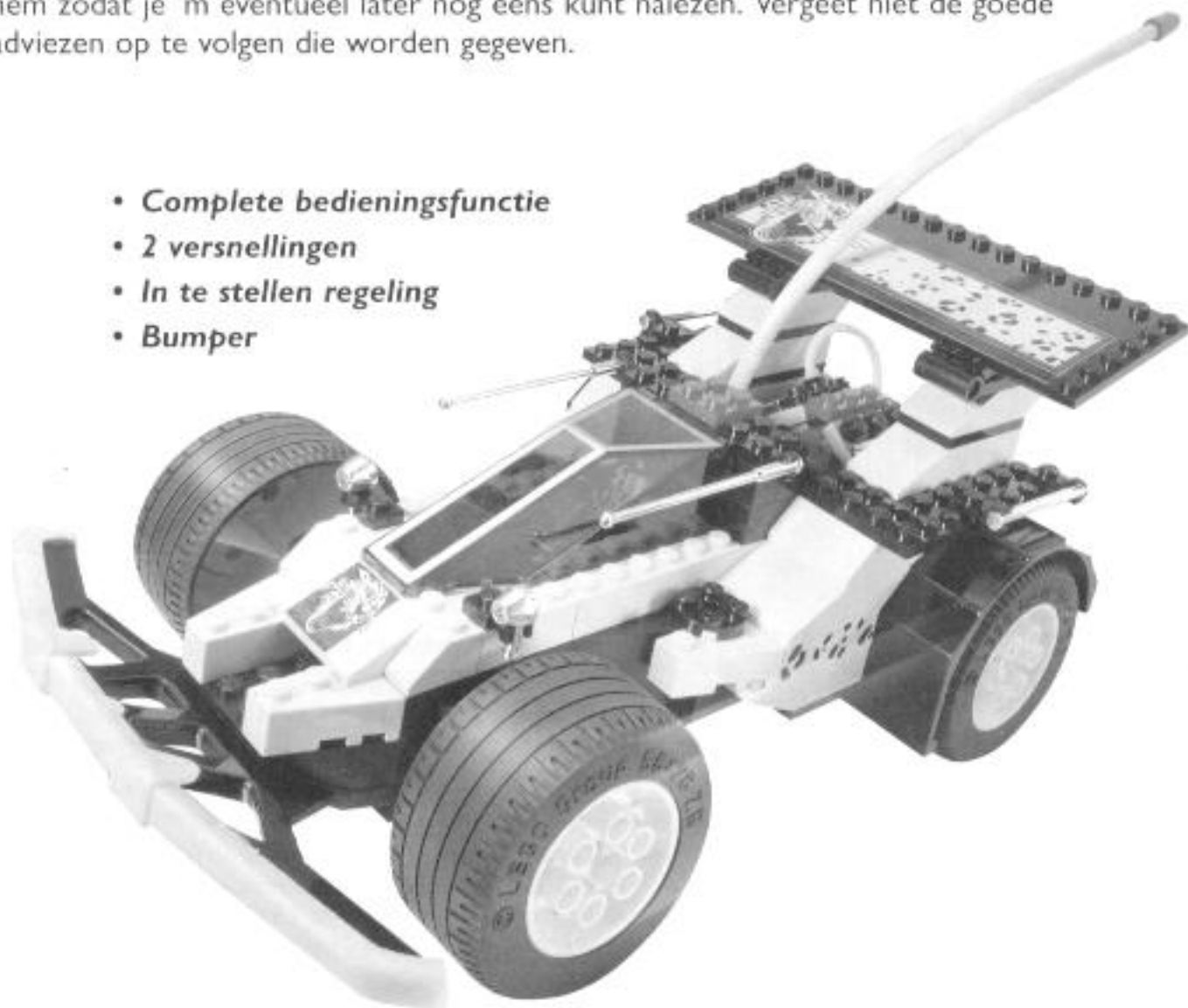

Belangrijke mededeling

Wanneer je het product gebruikt, dien je het volgende in acht te nemen.

- Dit product is ontwikkeld om binnenshuis mee te spelen. Je bereikt het beste resultaat met de auto door op vloeren met een hard oppervlak zoals hout, tegels, linoleum of vloerbedekking met korte polen.
- Je bereikt de beste verbinding tussen de afstandsbediening en de bodem van de auto als je de antenne omhoog houdt en vóór de auto staat. Als de afstand tussen de auto en de afstandsbediening te groot wordt, zal het signaal zwakker worden en de auto niet langer op de afstandsbediening reageren. De maximale reikwijdte van de besturing van de auto ligt tussen de 5 en 10 meter, afhankelijk van de ontvangstcondities in de ruimte.
- Er kunnen storingen optreden in de functies van de auto als er meerdere radiogestuurde auto's op dezelfde frequentie rijden. Gebruik daarom altijd maar één auto op dezelfde frequentie.
- Er kunnen storingen optreden in de functies van de auto als de auto in de buurt van gewapend beton, computers, CB radio's of hoogspanningsleidingen wordt gebruikt.

Waarschuwing

- Speel niet buiten met het product. Zand en water kunnen de elektronische delen in de auto beschadigen.
- Laat de auto niet op hoogpolige tapijten rijden, aangezien dit de motor van de auto kan beschadigen.
- Houd de auto of de afstandsbediening niet bij de antenne vast.
- Plaats de auto of de afstandsbediening nooit in de buurt van warmtebronnen of in de volle zon.
- Voorkom stoten en botsen van de auto. Laat 'm dus niet vallen.

Batterijen

- Voor de auto moeten 4 x 1,5 V (LR6) batterijen worden gebruikt. (Niet inbegrepen).
- Voor de afstandsbediening moet een 1 x 9 V (6LR61) batterij worden gebruikt. (Niet inbegrepen).
- Aanbevolen wordt alkaline batterijen te gebruiken. Oplaadbare batterijen kunnen ook worden gebruikt.

Batterijen aanbrengen

De afstandsbediening

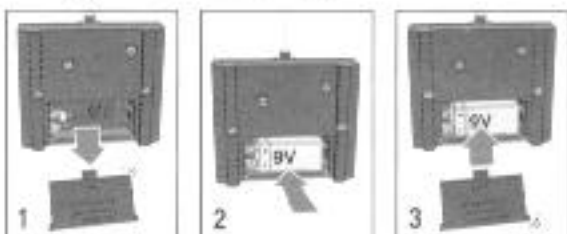

- Duw het batterijdeksel in de richting van de pijl en verwijder het deksel.
- Zet er zoals afgebeeld een 1 x 9 V (6LR61) batterij in. Let erop dat de polen (+/-) van de batterij correct liggen.
- Sluit het deksel door het tegen de richting van de pijl in te duwen.

De auto

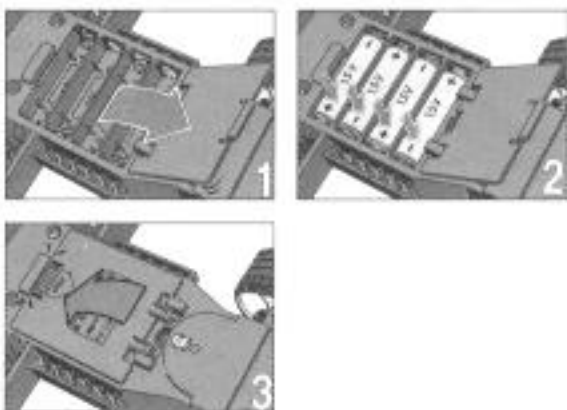

- Duw het batterijdeksel in de richting van de pijl en verwijder het deksel.
- Zet er zoals afgebeeld 4 x 1,5 V (LR6) batterijen in. Let erop dat de polen (+/-) van de batterijen correct liggen.
- Sluit het deksel door het tegen de richting van de pijl in te duwen.

De 9V (6LR61) batterij voor de afstandsbediening heeft een langere levensduur dan de 1,5V (LR6) batterijen voor de auto. Het kan dus nodig zijn de batterijen in de auto vaker te verwisselen.

Opgelet!

- Gebruik niet tegelijkertijd nieuwe en gebruikte batterijen.
- Gebruik niet tegelijkertijd verschillende typen batterijen zoals alkaline, standaard of oplaadbare batterijen.
- Als er oplaadbare batterijen worden gebruikt, moeten de instructies van de leverancier van de batterijen en de batterijlader nauwkeurig worden gevolgd. Je moet altijd het volgende in acht nemen:
 - probeer nooit niet-oplaadbare batterijen op te laden
 - oplaadbare batterijen moeten voor het opnieuw opladen uit de batterijdoos gehaald worden.
 - het opladen van oplaadbare batterijen mag uitsluitend onder toezicht van een volwassene worden gedaan.
- De batterijen moeten op de juiste polariteit worden gezet. Zie handleiding.
- Lege batterijen moeten uit het speelgoed worden gehaald.
- Verwijder de batterijen als het product langere tijd niet wordt gebruikt. Laat nooit lege batterijen in de units zitten, want corrosie en lekkage van de batterijen kunnen de auto of de afstandsbediening beschadigen.
- Voorkom kortsluiting van de polen op de batterijen.
- Lege batterijen horen bij het chemisch afval en mogen nooit bij het normale afval worden weggegooid.

De auto

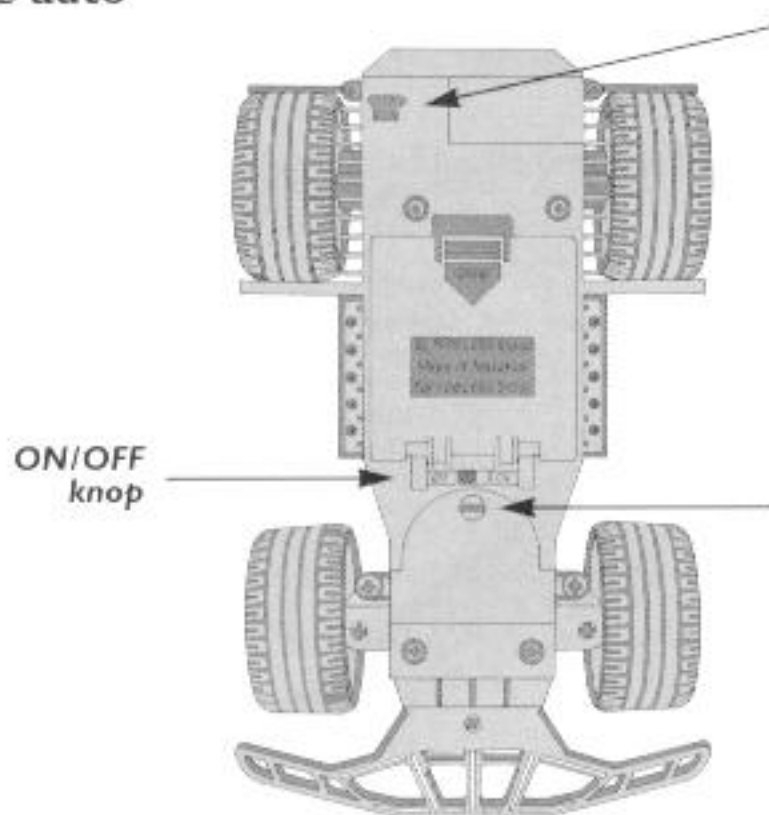

Versnelling

- I – Snel, goed om op grote, vrije stukken te rijden
- II – Langzaam, goed als nauwkeurig sturen / manoeuvreren belangrijk is

Nauwkeurige afstelling van de besturing

De auto zou, ook al wordt hij niet afgesteld, rechthoek moeten rijden. Als dit echter niet het geval is, moet de schroef naar rechts of links worden gedraaid totdat de auto rechthoek rijdt.

Gebruiksaanwijzing

1. Zet de auto aan op de ON/OFF knop op de onderzijde van de auto.
2. Kies de snelheid door de bedieningsknop van de versnelling in een van de volgende standen te duwen:
 - I – snel
 - II – langzaam

Opgelet: als de bedieningsknop niet vrij kan worden bewogen, draai dan enigszins aan de achterwielen van de auto met de ene hand en duw op de bedieningsknop met de andere hand.
3. Zet de ON/OFF knop in de OFF stand om de auto uit te zetten.

N.B.

Zet de auto uit, als hij niet gebruikt wordt. Hierdoor zullen de batterijen langer meegaan.

Afstandsbediening

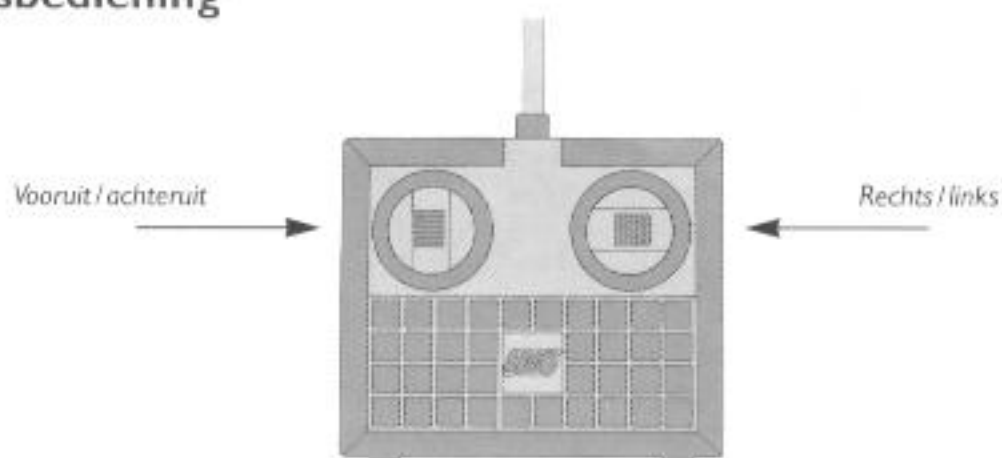

Gebruiksaanwijzing

1. De afstandsbediening gaat automatisch aan als een van de contactknoppen wordt geactiveerd.
2. De afstandsbediening gaat automatisch uit als hij niet wordt gebruikt.

Problemen oplossen

<i>Probleem</i>	<i>Mogelijke oorzaak</i>	<i>Oplossen</i>
Geen functie / de auto rijdt niet	De ON/OFF knop is niet geactiveerd	Zet de knop op de ON stand
	De batterijen zijn er verkeerd ingezet	Haal de batterijen eruit en zet ze er op de juiste manier in zoals afgebeeld
	De accupolen zijn vuil	Maak de polen schoon
De auto rijdt te langzaam	De batterijen in de auto zijn zwak	Zet nieuwe batterijen in de auto
De besturing reageert niet volledig	De batterij in de afstandsbediening is zwak	Zet een nieuwe batterij in de afstandsbediening
	De batterijen in de auto zijn zwak	Zet nieuwe batterijen in de auto
De auto rijdt onregelmatig	Frequentiestoringen	Probeer ergens anders met de auto te rijden
	Zwak signaal	Houd de antenne omhoog
		Ga dichterbij de auto staan
		Zet nieuwe batterijen in de afstandsbediening of de auto

Heb je nog altijd problemen?

Als je de instructies en bovenstaand overzicht hebt gevolgd en er nog altijd problemen met je radiografisch bestuurbare auto zijn, kan je ons bellen op:

Nederland: 076 – 5731122

België: 03/226 26 19

of schrijven naar het volgende adres:

voor Nederland: LEGO Benelux B.V., afd. Consumenten Service, Postbus 9311, 4801 LH Breda

voor België: LEGO Belgium n.v., afd. Consumenten Service, Postbus 80, 2320 Hoogstraten-Meer

Vergeet niet je kwitantie en het adres van de winkel waar je de auto hebt gekocht te bewaren. Als je de auto cadeau hebt gekregen, zorg er dan voor dat de kwitantie op een veilige plaats wordt bewaard voor het geval dat er problemen ontstaan.

Véhicule téléguidé 5600 LEGO® SYSTEM

Instructions

Vous trouverez ci-après des instructions détaillées que vous devez suivre pour utiliser au mieux votre véhicule téléguidé.

- *Fonctions de direction*
- *2 vitesses*
- *Vitesse et direction réglables*
- *Pare-chocs*

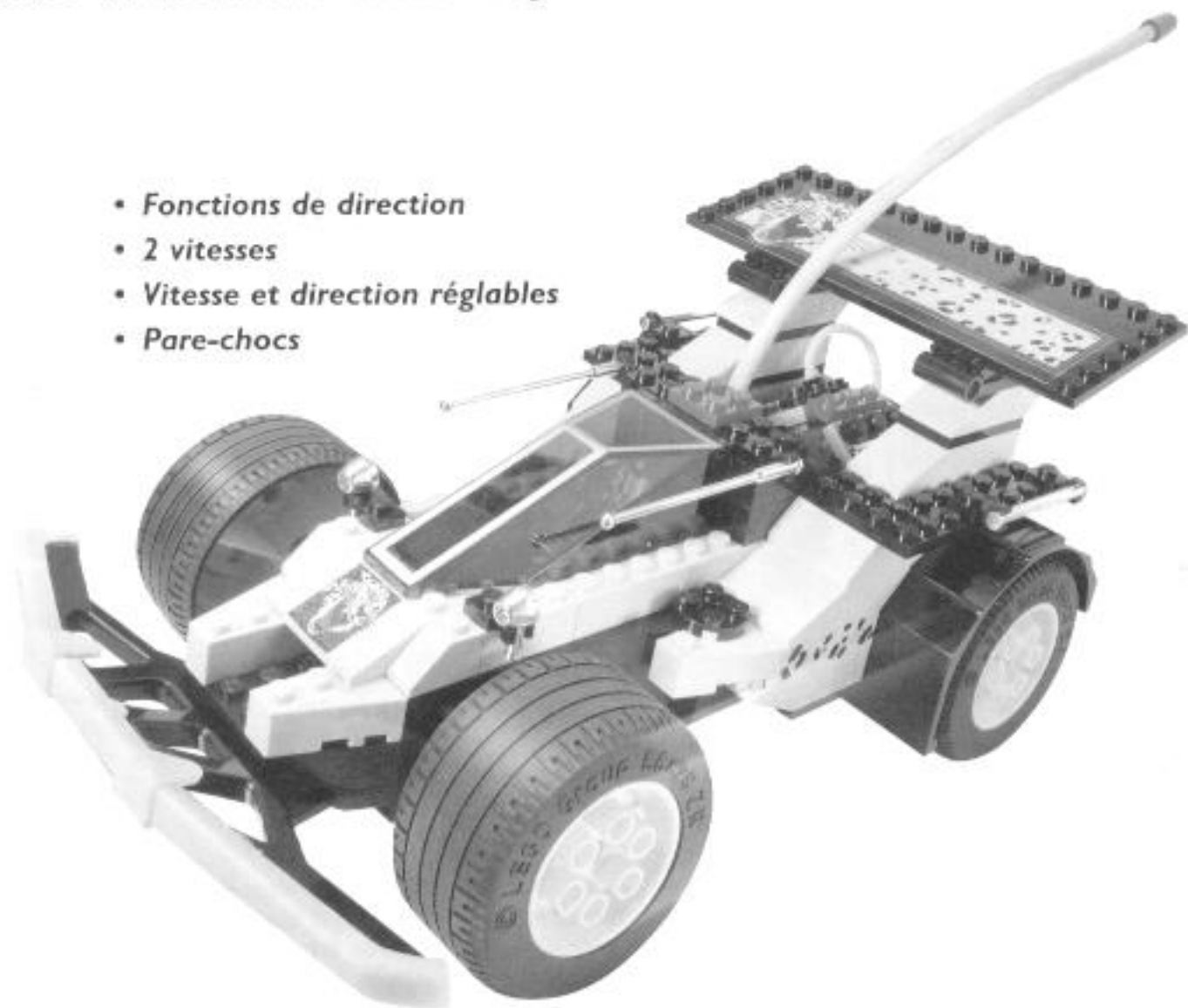

Informations importantes

A lire attentivement au moment de l'utilisation :

- Vous pourriez utiliser votre véhicule à l'extérieur, sur des surfaces bien planes, mais éloignées de sable ou d'eau qui pourraient endommager la voiture, mais ce jouet a été conçu pour une utilisation à l'intérieur, afin de garantir un maximum de performance. Vous obtiendrez de meilleurs résultats si vous faites évoluer votre véhicule sur de la moquette, du lino, du parquet ou du carrelage.
- Afin d'obtenir le meilleur rapport entre la commande et votre véhicule, vous devez, pour des résultats optimaux, vous assurer que l'antenne du boîtier-commande soit bien droite et dirigée bien en face du véhicule. Si le véhicule est trop loin du boîtier-commande, le signal provenant du boîtier sera trop faible et votre véhicule s'arrêtera. En règle générale, le boîtier-commande peut diriger le véhicule sur une distance de 5 à 10 mètres, tout dépend des conditions de transmission aux alentours.
- Des problèmes peuvent survenir provenant d'autres véhicules téléguidés dans la zone où vous intervenez sur la même fréquence. Il ne faut donc utiliser qu'un véhicule à la fois sur cette même fréquence.
- Des problèmes peuvent aussi intervenir dus à des interférences provenant de la structure de la maison, des équipements en micro-informatique, radio CB ou de lignes à haute-tension près de l'endroit où vous faites évoluer votre véhicule.

Attention

- Ne pas utiliser votre véhicule dehors, surtout près de sable ou d'eau, ceci risquerait d'endommager le circuit.
- Ne pas utiliser votre véhicule sur de la moquette trop épaisse, elle risquerait de l'endommager.
- Ne tenez pas le véhicule ou le boîtier-commande par l'antenne.
- Ne pas exposer le véhicule à de fortes chaleurs ou au soleil direct.

Piles nécessaires

- 4 piles x 1,5 V (LR6) pour la voiture (non fournies)
- 1 pile x 9 Volts (6LR61) pour la commande (non fournies)
- Piles Alcaline conseillées. Des piles rechargeables peuvent aussi être utilisées.

Mise en place des piles

Boîtier-commande

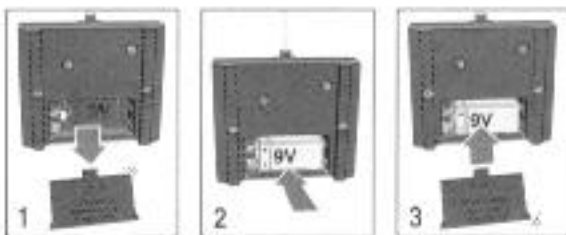

- Faire glisser et ôter le couvercle du boîtier-piles
- Insérer la pile 1x 9 Volts (6LR61) comme indiqué. Attention à bien respecter les pôles + et -
- Replacer le couvercle du boîtier-piles et appuyer légèrement pour la fermer.

Voiture

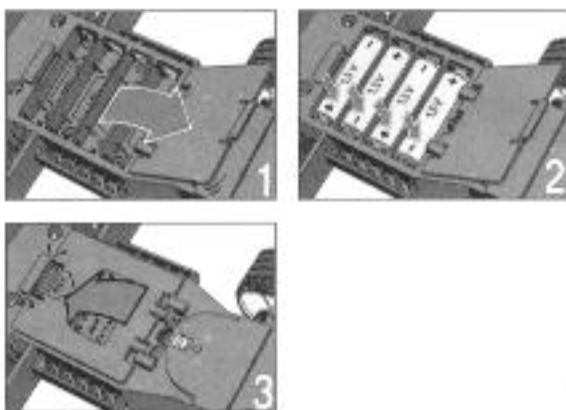

- Faire glisser et ôter le couvercle du boîtier-piles
- Insérer la pile 1x 9 Volts (6LR61) comme indiqué. Attention à bien respecter les pôles + et -
- Replacer le couvercle du boîtier-piles et appuyer légèrement pour la fermer.

La pile 9 Volts (6LR61) installée dans le boîtier-commande a une durée de vie plus longue que les piles 1,5 Volts (LR6) contenues dans le véhicule. Il peut s'avérer nécessaire de remplacer plus souvent les piles du véhicule.

Conseils utiles pour les piles

- Ne jamais mélanger des piles usagées et des neuves
 - Ne jamais mélanger des piles alcalines, standard (carbone zinc) ou rechargeables (nickel-cadmium)
 - Si vous utilisez des piles rechargeables, suivez toujours scrupuleusement les instructions du fabricant
- Note :
- N'essayez pas de recharger des piles non-rechargeables
 - Ne laissez pas les piles dans votre voiture ou dans le boîtier-commande lorsque vous êtes en train de recharger
 - Recharger des piles rechargeables doit se faire sous la surveillance d'un adulte
- Insérer les piles en suivant les indications +/- inscrites dans le compartiment.
 - Pour éviter des fuites de liquide, enlever les piles usagées ou mortes du boîtier-commande
 - Penser à ôter les piles de la voiture et du boîtier-commande en cas de non-utilisation prolongée de votre véhicule.

Le véhicule

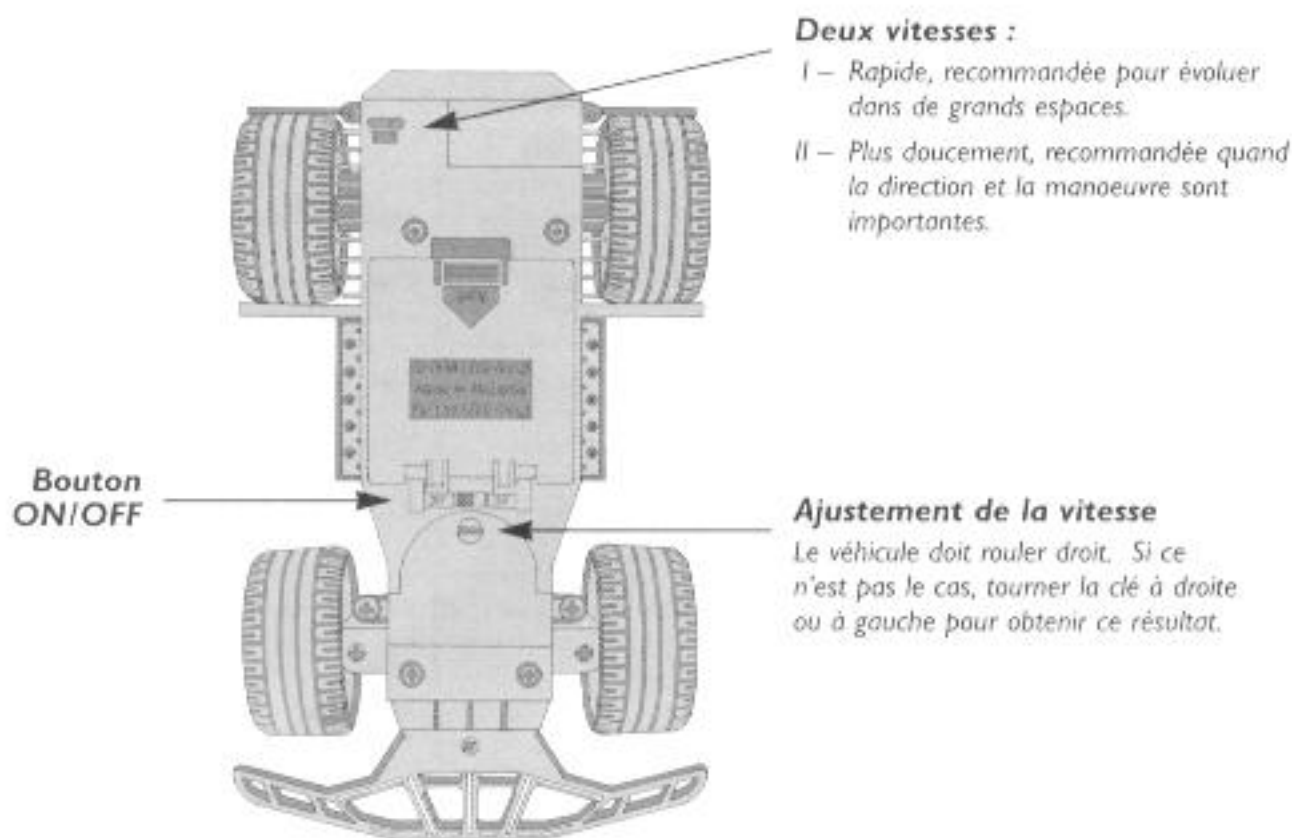

Instructions

1. Pour démarrer, appuyer sur le bouton au dos du véhicule, position « ON ».
2. Choisissez votre vitesse.
Attention : Si le bouton de contrôle ne bouge pas, tourner les roues arrière du véhicule d'une main, et activer le bouton de contrôle de l'autre.
3. Pour éteindre le véhicule, tourner le bouton sur position « OFF ».

Attention

Eteindre le véhicule lorsque vous ne l'utilisez pas, pour économiser les piles.

Boîtier-commande

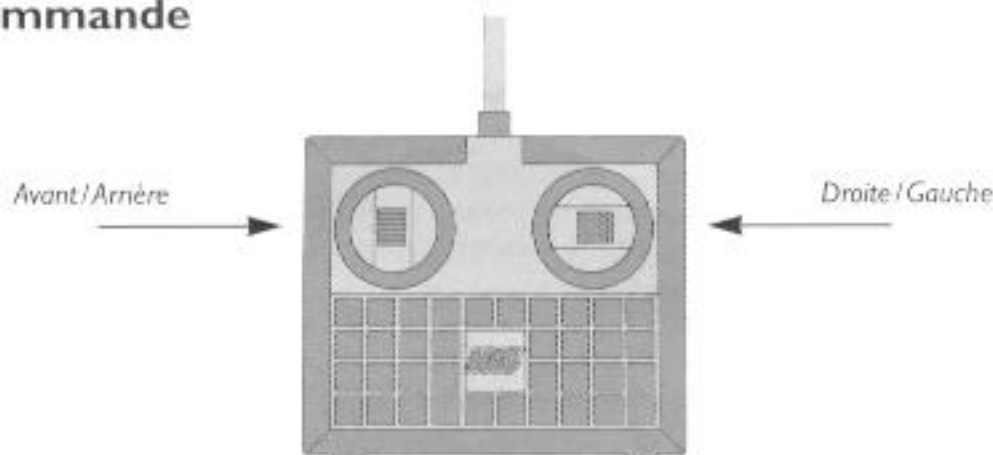

Instructions

1. Le boîtier-commande est automatiquement en fonction dès lors que l'un des boutons est activé.
2. Le boîtier-commande se met automatiquement hors tension lorsqu'il n'est pas utilisé.

Dépannage

Problème	Cause/raison possible	Solution
La voiture ne marche pas	Le bouton ON/OFF n'est pas activé	Mettez le bouton sur la position ON
	Les piles ne sont pas bien mises	Otez les piles et placez-les correctement (voir instructions)
	Les extrémités des piles sont sales	Nettoyez les extrémités des piles
La voiture roule trop lentement	Les piles de la voiture sont usées	Changez les piles de la voiture
La voiture ne répond pas pleinement à la direction :	Les piles de la commande sont usées	Changez les piles de la commande
	Les piles de la voiture sont usées	Changez les piles de la voiture
La voiture roule irrégulièrement	Problèmes d'interférences	Changez d'endroit pour faire évoluer votre voiture et voyez si c'est différent
	Signaux de faiblesse	Mettez l'antenne droite
		Rapprochez-vous de la voiture
		Insérez de nouvelles piles dans la voiture ou la commande

Si les problèmes persistent

Si vous avez bien suivi les instructions, et essayé toutes les solutions proposées dans la rubrique Dépannage, et que vous avez toujours des problèmes avec votre véhicule téléguidé LEGO® SYSTEM, appelez notre service Consommateurs au :

France : 02.37.91.85.25

Belgique : 03 231 17 78

ou écrivez-nous à l'adresse suivante :











France : LEGO FRANCE S.A., Service Consommateurs, B.P. 837 - 28011 CHARTRES Cedex

Belgique : LEGO Benelux B.V., Service Clientèle de LEGO, Minervum 1639, NL-4817 ZL Breda

N'oubliez pas de vous munir de votre ticket de caisse et de l'adresse du magasin où vous avez acheté ce véhicule. S'il s'agit d'un cadeau, merci de demander un reçu à conserver précieusement en cas de problèmes.



4112870/71989 © 1998 LEGO GROUP

Image	Qty	Item No	Description	MID
Regular Items:				
Parts:				
+ 	2	104	Chrome Silver Antenna 6H - no stud receptacle Catalog: Parts: Antenna Part Color Code Missing	PG
+ 	4	71183	Chrome Silver Bar 1L with 1 x 1 x 2/3 Light Holder Catalog: Parts: Bar Part Color Code Missing	PG
+ 	4	71184	Chrome Silver Bar 4.5L with Stop Ends Catalog: Parts: Bar Part Color Code Missing	PG
+ 	2	2436	Red Bracket 1 x 2 - 1 x 4 Catalog: Parts: Bracket 243621 or 4282742	PG
+ 	2	3005	Yellow Brick 1 x 1 Catalog: Parts: Brick 300524	PG
+ 	2	3004	Black Brick 1 x 2 Catalog: Parts: Brick 300426	PG
+ 	1	3004	Green Brick 1 x 2 Catalog: Parts: Brick 4107736	PG
+ 	3	3004	Red Brick 1 x 2 Catalog: Parts: Brick 4613961 or 300421	PG
+ 	2	3004	Yellow Brick 1 x 2 Catalog: Parts: Brick 4613966 or 300424	PG
+ 	1	3010	Black Brick 1 x 4 Catalog: Parts: Brick 301026	PG
+ 	2	3010	Green Brick 1 x 4 Catalog: Parts: Brick 4112838	PG

+



*

2

[3010](#)

Red Brick 1 x 4

[Catalog:](#) [Parts:](#) [Brick](#)
301021

[PG](#)

+



*

4

[3010](#)

Yellow Brick 1 x 4

[Catalog:](#) [Parts:](#) [Brick](#)
301024

[PG](#)

+



*

4

[3009](#)

Green Brick 1 x 6

[Catalog:](#) [Parts:](#) [Brick](#)
300928 or 4111844

[PG](#)

+



*

2

[3009](#)

Yellow Brick 1 x 6

[Catalog:](#) [Parts:](#) [Brick](#)
300924

[PG](#)

+



*

2

[3008](#)

Black Brick 1 x 8

[Catalog:](#) [Parts:](#) [Brick](#)
300826

[PG](#)

+



*

2

[3003](#)

Black Brick 2 x 2

[Catalog:](#) [Parts:](#) [Brick](#)
300326

[PG](#)

+

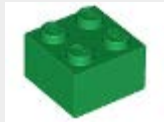

*

2

[3003](#)

Green Brick 2 x 2

[Catalog:](#) [Parts:](#) [Brick](#)
300328

[PG](#)

+



*

1

[3003](#)

Red Brick 2 x 2

[Catalog:](#) [Parts:](#) [Brick](#)
300321

[PG](#)

+



*

4

[3002](#)

Black Brick 2 x 3

[Catalog:](#) [Parts:](#) [Brick](#)
300226

[PG](#)

+



*

2

[3002](#)

Yellow Brick 2 x 3

[Catalog:](#) [Parts:](#) [Brick](#)
300224

[PG](#)

+



*

3

[3001](#)

Black Brick 2 x 4

[Catalog:](#) [Parts:](#) [Brick](#)
300126

[PG](#)

+



*

2

[3001](#)

Green Brick 2 x 4

[Catalog:](#) [Parts:](#) [Brick](#)
4106356

[PG](#)

+	 *	2	3001pb007	Yellow Brick 2 x 4 with Black Animal Spots Pattern Catalog: Parts: Brick, Decorated Part Color Code Missing	PG
---	---	---	---------------------------	---	--------------------

+	 *	3	6213pb07	Black Brick 2 x 6 x 3 with Flame 10 Pattern Catalog: Parts: Brick, Decorated Part Color Code Missing	PG
---	--	---	--------------------------	--	--------------------

+	 *	2	6213pb08	Black Brick 2 x 6 x 3 with Flame 30 Pattern Catalog: Parts: Brick, Decorated Part Color Code Missing	PG
---	--	---	--------------------------	--	--------------------

+	 *	1	6213pb09	Black Brick 2 x 6 x 3 with Flame 50 Pattern Catalog: Parts: Brick, Decorated Part Color Code Missing	PG
---	--	---	--------------------------	--	--------------------

+	 *	2	4070	Black Brick, Modified 1 x 1 with Headlight Catalog: Parts: Brick, Modified 407026	PG
---	--	---	----------------------	--	--------------------

+	 *	2	4070	Light Gray Brick, Modified 1 x 1 with Headlight Catalog: Parts: Brick, Modified 407002	PG
---	---	---	----------------------	---	--------------------

+	 *	6	2653	Black Brick, Modified 1 x 4 with Groove Catalog: Parts: Brick, Modified 265326	PG
---	--	---	----------------------	---	--------------------













+	 *	2	3062b	Black Brick, Round 1 x 1 Open Stud Catalog: Parts: Brick, Round 306226	PG
---	--	---	-----------------------	---	--------------------

+	 *	2	4589	Red Cone 1 x 1 without Top Groove Catalog: Parts: Cone 4529234 or 458921	PG
---	--	---	----------------------	---	--------------------

+	 *	1	x490c01	Black Electric, RC Car Base (Sets 5599 / 5600) Catalog: Parts: Electric Part Color Code Missing	PG
---	--	---	-------------------------	---	--------------------

+	 *	1	x491c01	Black Electric, RC Controller (Sets 5599 / 5600) Catalog: Parts: Electric Part Color Code Missing	PG
---	--	---	-------------------------	---	--------------------

+	 *	2	3475b	Black Engine, Smooth Small, 1 x 2 Side Plate with Axle Holders Catalog: Parts: Aircraft 347526	PG
---	--	---	-----------------------	---	--------------------

+	 *	3	3937	Red Hinge Brick 1 x 2 Base	Catalog: Parts: Hinge 393721	PG
+	 *	3	3938	Light Gray Hinge Brick 1 x 2 Top	Catalog: Parts: Hinge 393802	PG
+	 *	2	3149c01 (inv)	Black Hinge Plate 2 x 4	Catalog: Parts: Hinge Part Color Code Missing	PG
+	 *	2	4213	Black Hinge Vehicle Roof 4 x 4	Catalog: Parts: Hinge Part Color Code Missing	PG
+	 *	3	4315	Black Hinge Vehicle Roof Holder 1 x 4	Catalog: Parts: Hinge Part Color Code Missing	PG
+	 *	2	73590c02b	Yellow Hose, Flexible 8.5L with Tabbed Ends Black (Ends different color than Tube)	Catalog: Parts: Hose 621133 or 4501980	PG
+	 *	2	75c11	Yellow Hose, Rigid 3mm D. 11L / 8.8cm	Catalog: Parts: Hose, Rigid 3mm D. Part Color Code Missing	PG
+	 *	2	71182	Chrome Silver Minifigure, Utensil Car Air Horn	Catalog: Parts: Minifigure, Utensil Part Color Code Missing	PG
+	 *	1	4079	Green Minifigure, Utensil Seat (Chair) 2 x 2	Catalog: Parts: Minifigure, Utensil 4296197	PG
+	 *	1	5600cdb02	Paper, Cardboard RC Racer Bridge Panel for Set 5600	Catalog: Parts: Paper	PG
+	 *	2	5600cdb01	Paper, Cardboard RC Racer Ramp for Set 5600	Catalog: Parts: Paper	PG
+	 *	4	3023	Black Plate 1 x 2	Catalog: Parts: Plate 302326	PG

+	 *	4	3023	Green Plate 1 x 2 Catalog: Parts: Plate 302328	PG
---	---	---	----------------------	---	--------------------

+	 *	2	3023	Yellow Plate 1 x 2 Catalog: Parts: Plate 302324	PG
---	--	---	----------------------	--	--------------------

+	 *	2	3623	Black Plate 1 x 3 Catalog: Parts: Plate 362326	PG
---	--	---	----------------------	---	--------------------

+	 *	2	3623	Green Plate 1 x 3 Catalog: Parts: Plate 4107758	PG
---	--	---	----------------------	--	--------------------

+	 *	2	3623	Red Plate 1 x 3 Catalog: Parts: Plate 362321	PG
---	--	---	----------------------	---	--------------------

+	 *	2	3710	Black Plate 1 x 4 Catalog: Parts: Plate 371026	PG
---	--	---	----------------------	---	--------------------

+	 *	5	3710	Green Plate 1 x 4 Catalog: Parts: Plate 371028	PG
---	--	---	----------------------	---	--------------------

+	 *	2	3666	Black Plate 1 x 6 Catalog: Parts: Plate 366626	PG
---	--	---	----------------------	---	--------------------

+	 *	4	3666	Green Plate 1 x 6 Catalog: Parts: Plate 366628	PG
---	--	---	----------------------	---	--------------------

+	 *	2	3460	Red Plate 1 x 8 Catalog: Parts: Plate 346021	PG
---	--	---	----------------------	---	--------------------

+	 *	1	3022	Black Plate 2 x 2 Catalog: Parts: Plate 302226	PG
---	--	---	----------------------	---	--------------------

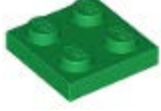
+	 *	1	3022	Green Plate 2 x 2 Catalog: Parts: Plate 302228	PG
---	--	---	----------------------	---	--------------------

+	 *	2	3022	Red Plate 2 x 2 Catalog: Parts: Plate 4613974 or 302221	PG
---	---	---	----------------------	--	--------------------

+	 *	2	3021	Light Gray Plate 2 x 3 Catalog: Parts: Plate 302102	PG
---	--	---	----------------------	--	--------------------

+	 *	2	3020	Black Plate 2 x 4 Catalog: Parts: Plate 302026	PG
---	--	---	----------------------	---	--------------------

+	 *	1	3020	Green Plate 2 x 4 Catalog: Parts: Plate 302028	PG
---	--	---	----------------------	---	--------------------

+	 *	3	3795	Green Plate 2 x 6 Catalog: Parts: Plate 379528	PG
---	--	---	----------------------	---	--------------------

+	 *	2	3034	Green Plate 2 x 8 Catalog: Parts: Plate 303428	PG
---	---	---	----------------------	---	--------------------

+	 *	2	3035	Black Plate 4 x 8 Catalog: Parts: Plate 303526	PG
---	--	---	----------------------	---	--------------------

+	 *	8	6019	Black Plate, Modified 1 x 1 with Clip Horizontal (thick open U clip) Catalog: Parts: Plate, Modified 601926	PG
---	--	---	----------------------	--	--------------------

+	 *	2	4081b	Black Plate, Modified 1 x 1 with Clip Light - Thick Ring Catalog: Parts: Plate, Modified 4632571 or 6281993 or 408126	PG
---	--	---	-----------------------	--	--------------------

+	 *	2	4081b	Red Plate, Modified 1 x 1 with Clip Light - Thick Ring Catalog: Parts: Plate, Modified 4632572 or 4161412	PG
---	--	---	-----------------------	--	--------------------

+	 *	4	4085c	Black Plate, Modified 1 x 1 with Clip Vertical - Type 3 (thick U clip) Catalog: Parts: Plate, Modified 408526	PG
---	--	---	-----------------------	--	--------------------

+	 *	2	3794a	Light Gray Plate, Modified 1 x 2 with 1 Stud without Groove (Jumper) Catalog: Parts: Plate, Modified 379402	PG
---	--	---	-----------------------	--	--------------------

+  2 [4175](#) **Light Gray Plate, Modified 1 x 2 with Ladder**
[Catalog:](#) [Parts:](#) [Plate, Modified](#) [4100526](#) [PG](#)

+  2 [4510](#) **Black Plate, Modified 1 x 8 with Door Rail**
[Catalog:](#) [Parts:](#) [Plate, Modified](#) [4286009](#) [PG](#)

+  7 [4073](#) **Black Plate, Round 1 x 1**
[Catalog:](#) [Parts:](#) [Plate, Round](#) [614126](#) [PG](#)

+  7 [4073](#) **Red Plate, Round 1 x 1**
[Catalog:](#) [Parts:](#) [Plate, Round](#) [614121](#) [PG](#)

+  5 [4073](#) **Yellow Plate, Round 1 x 1**
[Catalog:](#) [Parts:](#) [Plate, Round](#) [614124](#) [PG](#)

+  2 [4032](#) **Black Plate, Round 2 x 2 with Axle Hole**
[Catalog:](#) [Parts:](#) [Plate, Round](#) [403226](#) [PG](#)

+  6 [4286](#) **Black Slope 33 3 x 1**
[Catalog:](#) [Parts:](#) [Slope](#) [428626](#) [PG](#)

+  6 [4286](#) **Green Slope 33 3 x 1**
[Catalog:](#) [Parts:](#) [Slope](#) [4107637](#) [PG](#)

+  4 [4286](#) **Red Slope 33 3 x 1**
[Catalog:](#) [Parts:](#) [Slope](#) [428621](#) [PG](#)

+  2 [4286](#) **Yellow Slope 33 3 x 1**
[Catalog:](#) [Parts:](#) [Slope](#) [428624](#) [PG](#)

+  3 [3298](#) **Red Slope 33 3 x 2**
[Catalog:](#) [Parts:](#) [Slope](#) [329821](#) [PG](#)

+  4 [3298](#) **Yellow Slope 33 3 x 2**
[Catalog:](#) [Parts:](#) [Slope](#) [329824](#) [PG](#)

+		2	4161	Yellow Slope 33 3 x 3 Catalog: Parts: Slope 4222035	PG
---	--	---	----------------------	--	--------------------

+		1	3297px5	Yellow Slope 33 3 x 4 with Roaring Cheetah Head Pattern Catalog: Parts: Slope, Decorated Part Color Code Missing	PG
---	---	---	-------------------------	---	--------------------

+		2	3040	Light Gray Slope 45 2 x 1 Catalog: Parts: Slope 4121933	PG
---	---	---	----------------------	--	--------------------

+		4	3040	Yellow Slope 45 2 x 1 Catalog: Parts: Slope 304024 or 4121965	PG
---	---	---	----------------------	--	--------------------

+		4	3039	Black Slope 45 2 x 2 Catalog: Parts: Slope 303926	PG
---	---	---	----------------------	--	--------------------

+		4	3039	Red Slope 45 2 x 2 Catalog: Parts: Slope 303921	PG
---	---	---	----------------------	--	--------------------

+		2	3038	Yellow Slope 45 2 x 3 Catalog: Parts: Slope Part Color Code Missing	PG
---	---	---	----------------------	--	--------------------







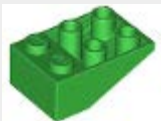





+		2	4287	Black Slope, Inverted 33 3 x 1 Catalog: Parts: Slope, Inverted 428726	PG
---	---	---	----------------------	--	--------------------

+		2	4287	Yellow Slope, Inverted 33 3 x 1 Catalog: Parts: Slope, Inverted 6254318 or 428724	PG
---	---	---	----------------------	--	--------------------

+		1	3747a	Black Slope, Inverted 33 3 x 2 without Connections between Studs Catalog: Parts: Slope, Inverted 4500458 or 374726	PG
---	---	---	-----------------------	---	--------------------

+		1	3747a	Green Slope, Inverted 33 3 x 2 without Connections between Studs Catalog: Parts: Slope, Inverted 4500456 or 4113071 or 4519945	PG
---	---	---	-----------------------	---	--------------------

+		2	3747a	Yellow Slope, Inverted 33 3 x 2 without Connections between Studs Catalog: Parts: Slope, Inverted 4500459 or 374724	PG
---	---	---	-----------------------	--	--------------------

+	 *	4	3660	Yellow Slope, Inverted 45 2 x 2 Catalog: Parts: Slope, Inverted 366024	PG
+	 *	1	5600stk01	Sticker for Set 5600 - (4112870/71989) Catalog: Parts: Sticker 4112870	PG
+	 *	2	32013	Black Technic, Axle and Pin Connector Angled #1 Catalog: Parts: Technic, Connector 6284699 or 4107085	PG
+	 *	2	6541	Yellow Technic, Brick 1 x 1 with Hole Catalog: Parts: Technic, Brick 654124	PG
+	 *	2	3673	Light Gray Technic, Pin without Friction Ridges Lengthwise Catalog: Parts: Technic, Pin 4184166	PG
+	 *	1	3069bp21	Black Tile 1 x 2 with Groove with Arrow Short Yellow without Black Border Pattern Catalog: Parts: Tile, Decorated Part Color Code Missing	PG
+	 *	1	2431	Black Tile 1 x 4 Catalog: Parts: Tile 243126	PG
+	 *	4	2412b	Chrome Silver Tile, Modified 1 x 2 Grille with Bottom Groove / Lip Catalog: Parts: Tile, Modified 4116794	PG
+	 *	1	6205	Black Tile, Modified 6 x 16 with Studs on Edges Catalog: Parts: Tile, Modified 6092509	PG
+	 *	1	bb0018	Yellow Vehicle, Bumper for RC Racer (Sets 5599 / 5600) Catalog: Parts: Vehicle Part Color Code Missing	PG
+	 *	2	3829c01	Red Vehicle, Steering Stand 1 x 2 with Black Steering Wheel Catalog: Parts: Vehicle 9552	PG
+	 *	1	6565	Black Wedge 3 x 2 Left Catalog: Parts: Wedge 4527766 or 656526	PG

+		1	6565	Green Wedge 3 x 2 Left Catalog: Parts: Wedge Part Color Code Missing	PG
	*				

+		1	6565	Red Wedge 3 x 2 Left Catalog: Parts: Wedge 4527765 or 656521	PG
	*				

+		3	6565	Yellow Wedge 3 x 2 Left Catalog: Parts: Wedge 6138215 or 4225515 or 4527769	PG
	*				

+		1	6564	Black Wedge 3 x 2 Right Catalog: Parts: Wedge 4526931 or 656426	PG
	*				

+		1	6564	Green Wedge 3 x 2 Right Catalog: Parts: Wedge Part Color Code Missing	PG
	*				

+		1	6564	Red Wedge 3 x 2 Right Catalog: Parts: Wedge 4526929 or 656421	PG
	*				

+		3	6564	Yellow Wedge 3 x 2 Right Catalog: Parts: Wedge 6138210 or 4225513 or 4526936	PG
	*				

+		1	6153a	Black Wedge 6 x 4 Cutout without Stud Notches Catalog: Parts: Wedge Part Color Code Missing	PG
	*				

+		2	2450	Green Wedge, Plate 3 x 3 Cut Corner Catalog: Parts: Wedge, Plate 6114672 or 4240408	PG
	*				

+		1	4859	Green Wedge, Plate 3 x 4 without Stud Notches Catalog: Parts: Wedge, Plate Part Color Code Missing	PG
	*				

+		2	2419	Green Wedge, Plate 3 x 6 Cut Corners Catalog: Parts: Wedge, Plate 241928	PG
	*				

+		2	6106	Black Wedge, Plate 6 x 6 Cut Corner Catalog: Parts: Wedge, Plate 4106977	PG
	*				

+  1 [3586](#) **Green Wedge, Plate 7 x 12 Wing Left** [PG](#)
[Catalog: Parts: Wedge, Plate](#)
 Part Color Code Missing

+  1 [3585](#) **Green Wedge, Plate 7 x 12 Wing Right** [PG](#)
[Catalog: Parts: Wedge, Plate](#)
 Part Color Code Missing

+  1 [3933](#) **Black Wedge, Plate 8 x 4 Wing Left** [PG](#)
[Catalog: Parts: Wedge, Plate](#)
 Part Color Code Missing

+  1 [3934](#) **Black Wedge, Plate 8 x 4 Wing Right** [PG](#)
[Catalog: Parts: Wedge, Plate](#)
 Part Color Code Missing

+  2 [3823](#) **Trans-Light Blue Windscreen 2 x 4 x 2** [PG](#)
[Catalog: Parts: Windscreen](#)
 6253682 or 382342

+  1 [2507pb03](#) **Trans-Dark Blue Windscreen 10 x 4 x 2 1/3 Canopy with Silver Lines Pattern** [PG](#)
[Catalog: Parts: Windscreen, Decorated](#)
 Part Color Code Missing

Minifigs:

+  1 [lea005\(inv\)](#) **Leather Jacket with Zippers - Black Legs, Black Helmet, Black Visor, Male** [PG](#)
[Catalog: Minifigs: Town: Classic Town](#)

Counterparts:

Parts:

+  1 [6205pb001](#) **Black Tile, Modified 6 x 16 with Studs on Edges with Roaring Cheetah Head on Yellow Rectangle Pattern (Sticker) - Sets 5599 / 5600** [PG](#)
[Catalog: Parts: Tile, Modified, Decorated](#)
 Part Color Code Missing

Summary:

Type	Unique Lots	Total Qty
Regular Items:		
Parts	125	294
Minifigs	1	1
Counterparts:		
Parts	1	1