

**LEGO**<sup>®</sup>

**TECHNIC**

42007





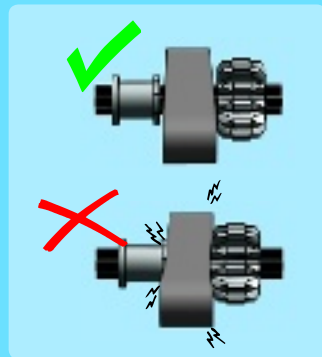
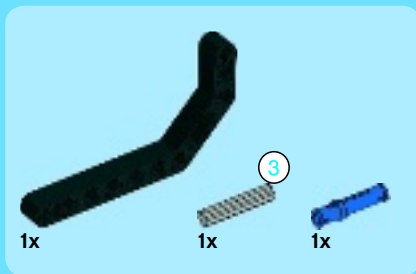

1

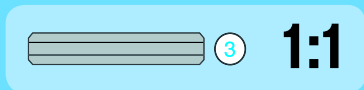

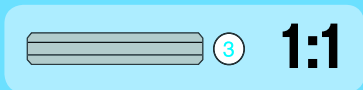

2

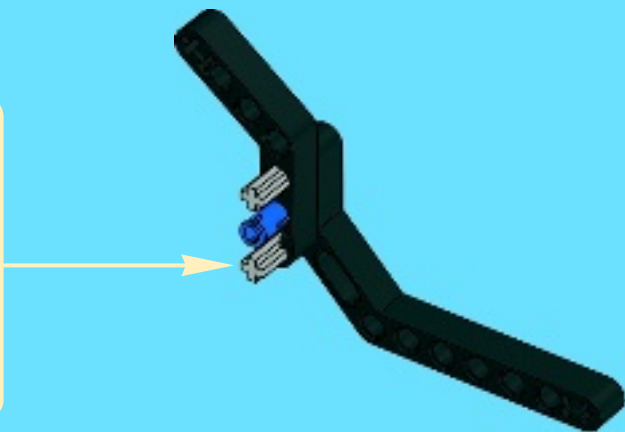

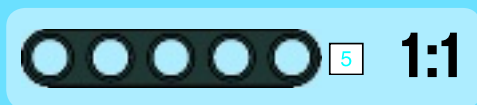

# 3

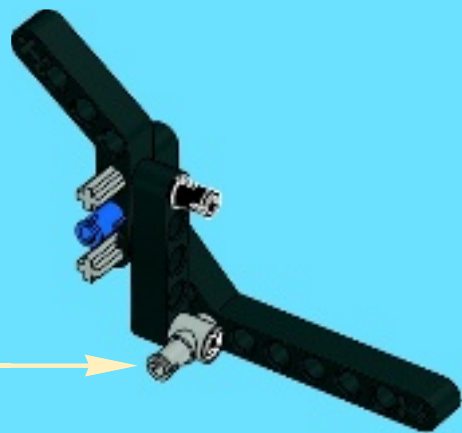
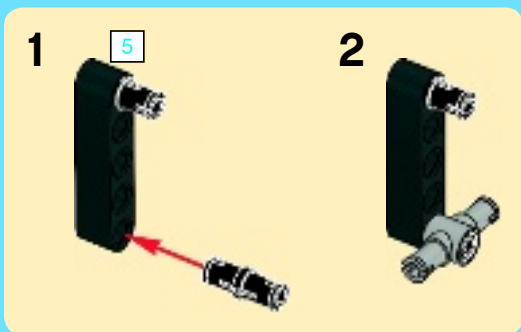



4

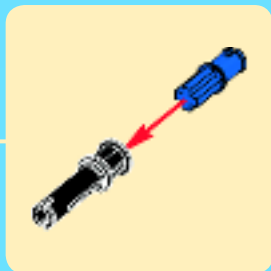
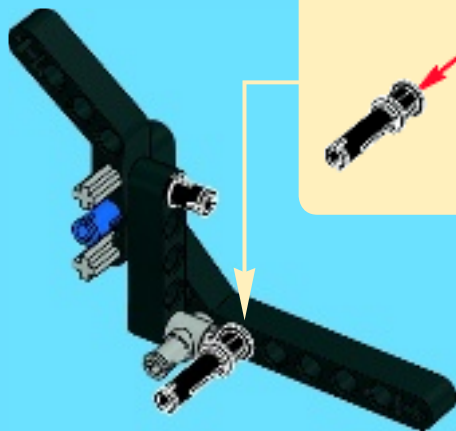

5

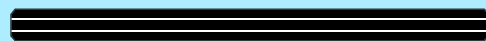
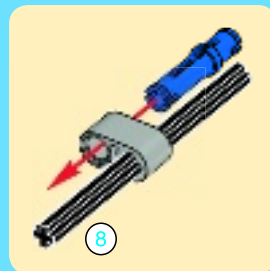
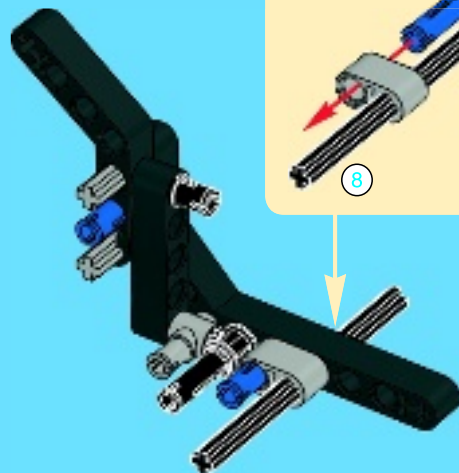

8

1:1



6

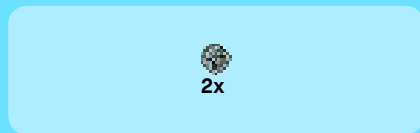

7





1x

1



2x

2

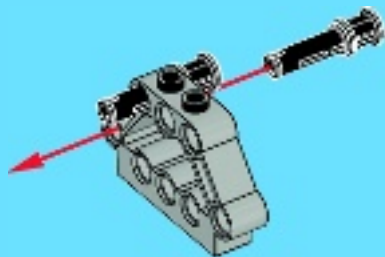





1x

3

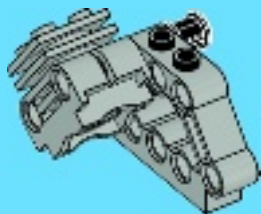

2x

4

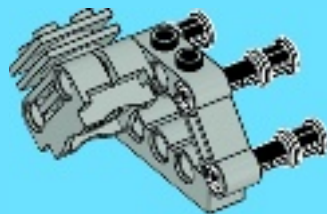



2x



2x



2x



1x

# 5

1



3



2

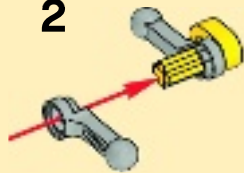

4

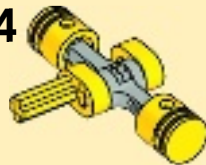

5

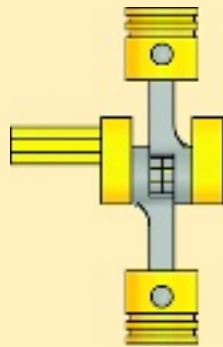

1:1

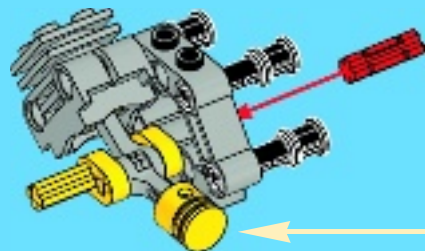



1x

6

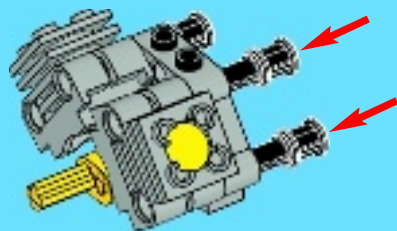

2x

7

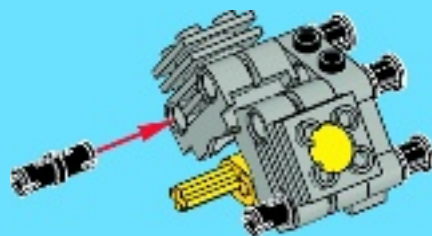



2x

8

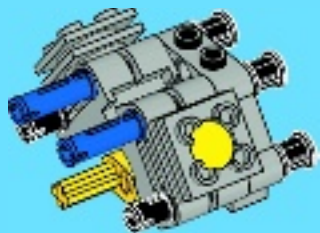

1x

9





1x



1x

# 10

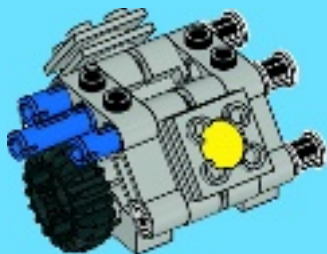

1x

# 11

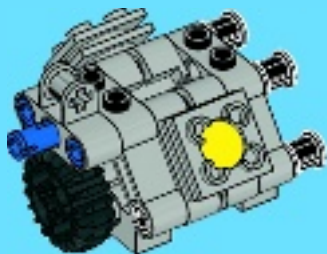



12



8

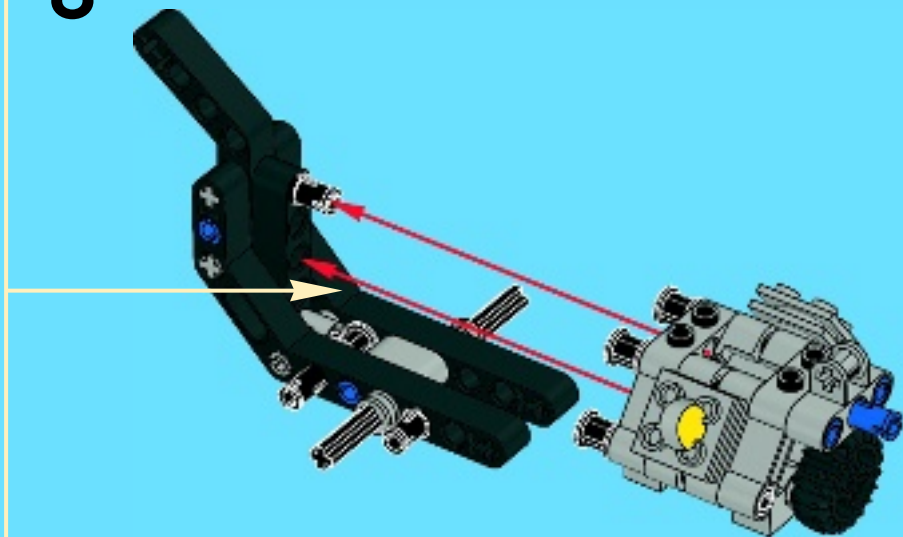

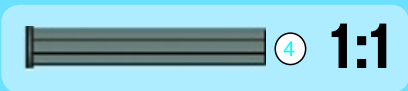
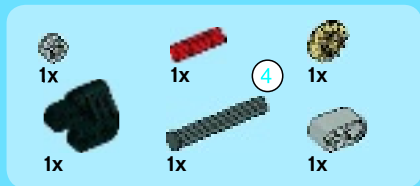

9

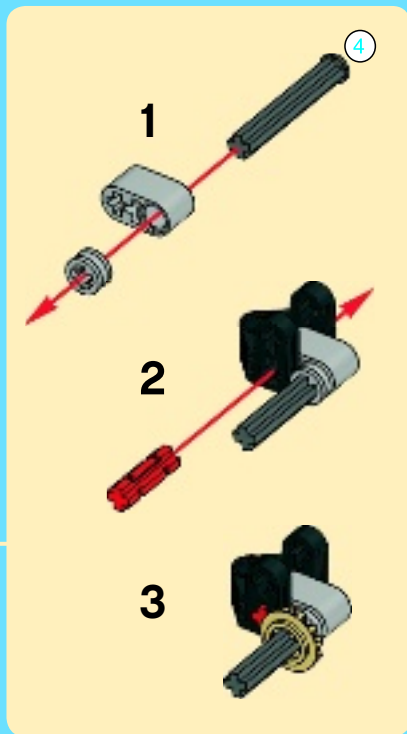

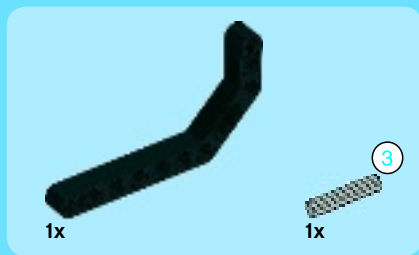

10

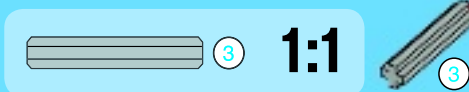
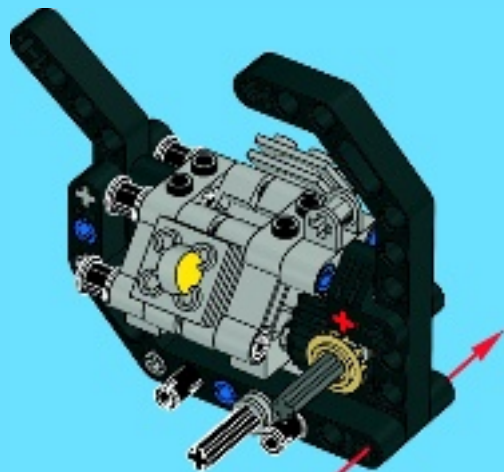

16



11

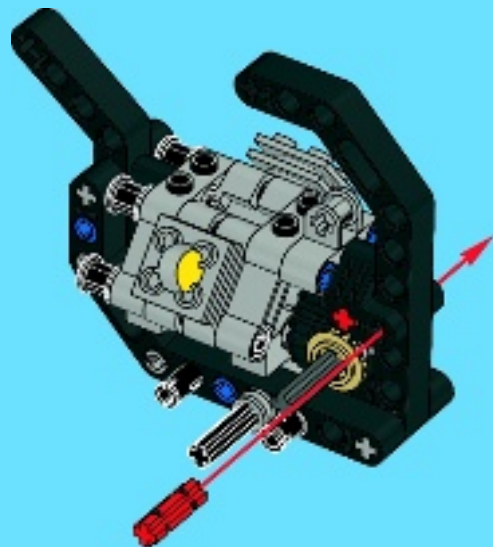



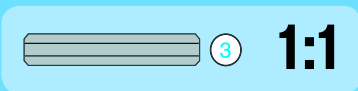
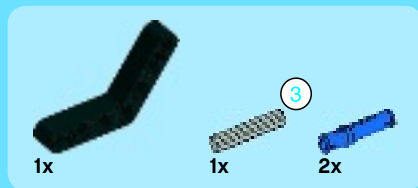

# 12

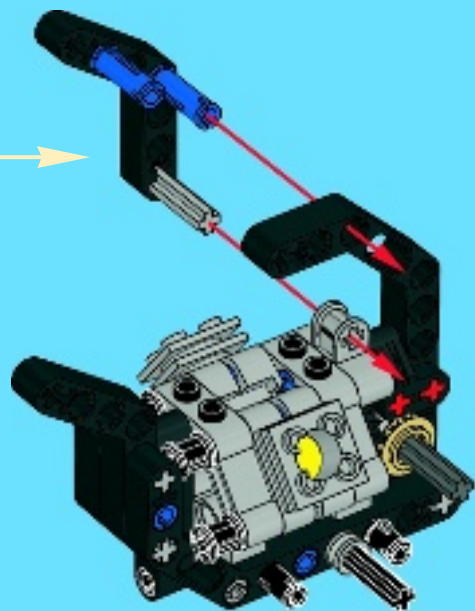
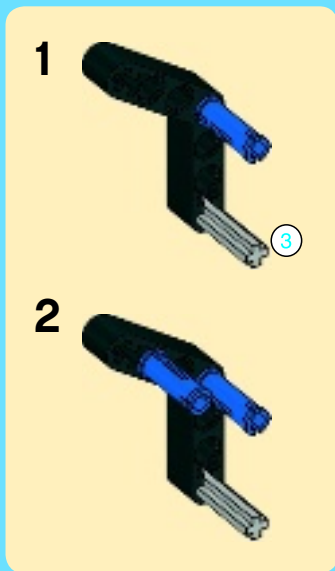

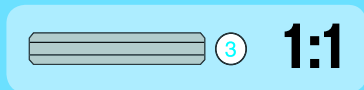

13

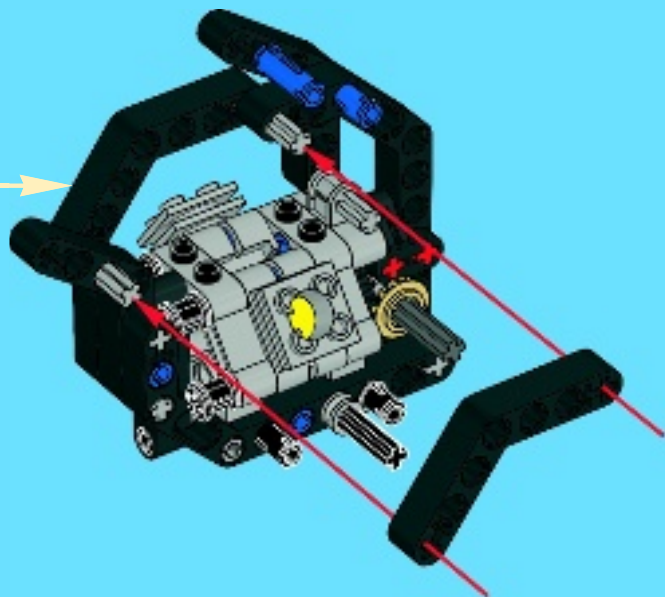
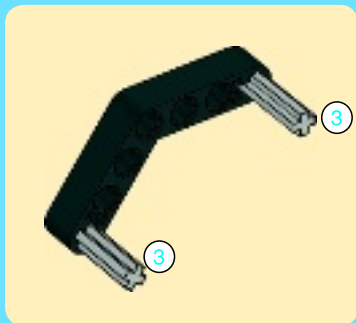



2x

# 14



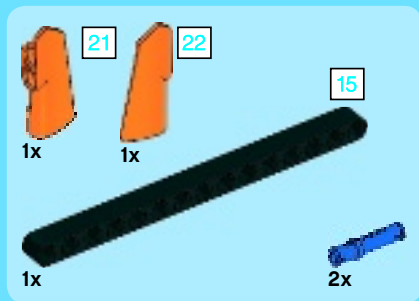

15

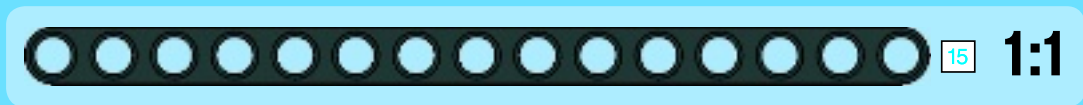
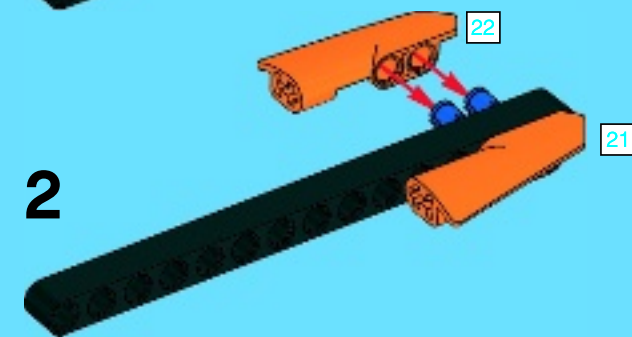

3

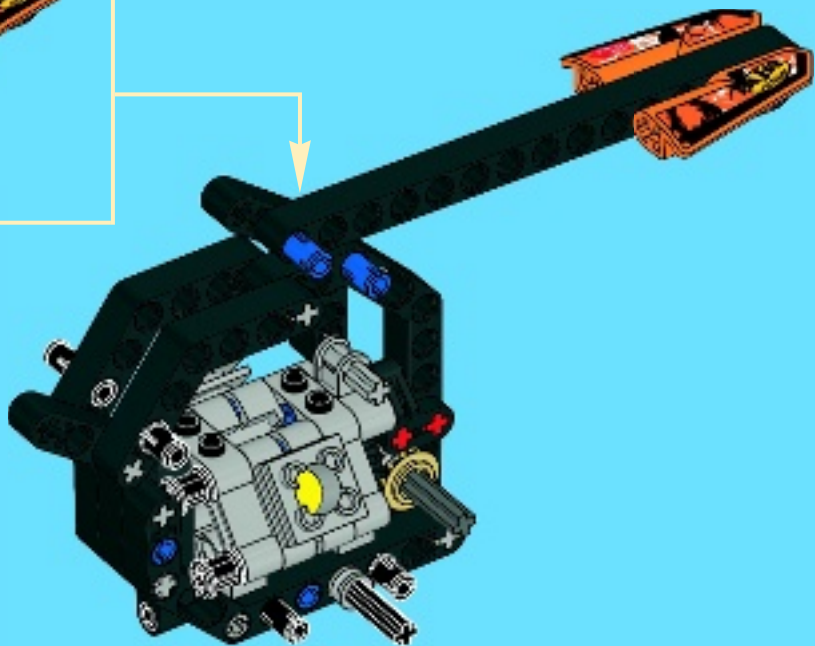
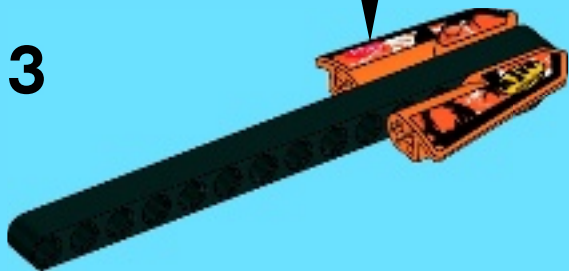

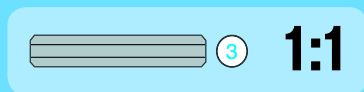
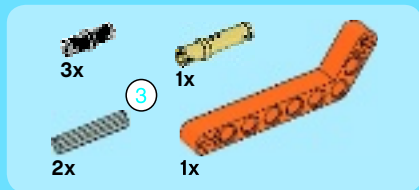

16

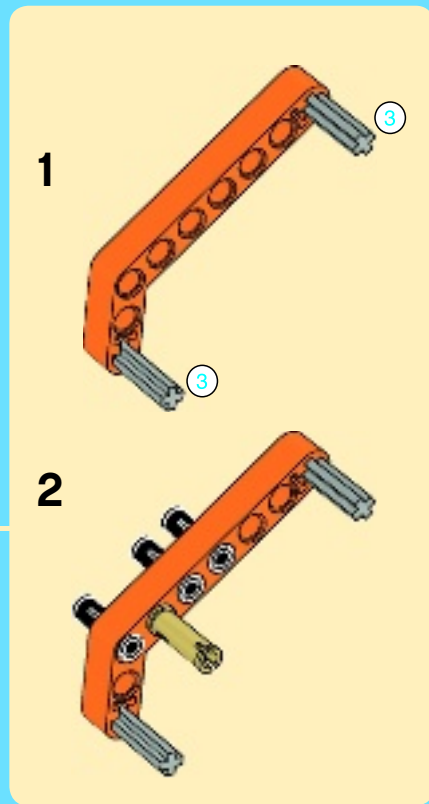
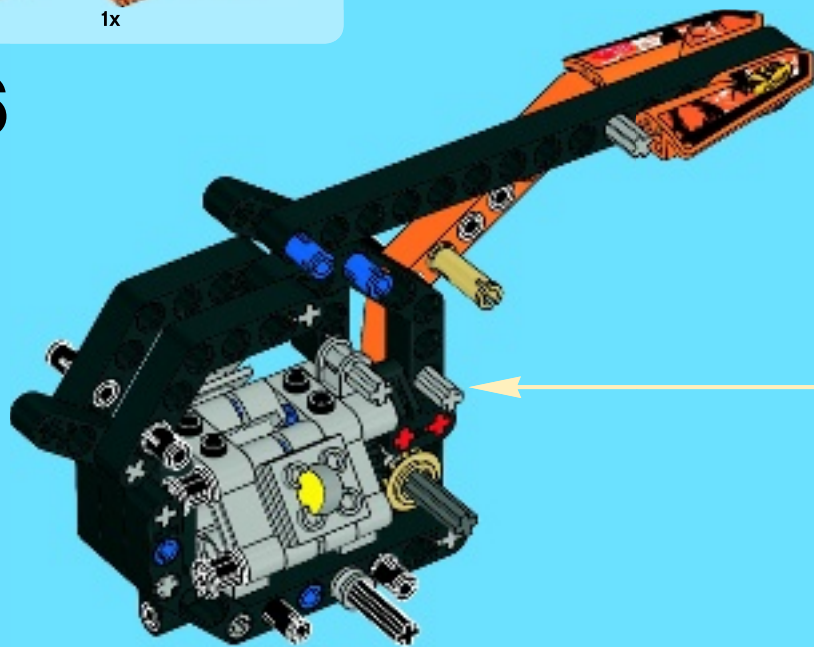



1x

17

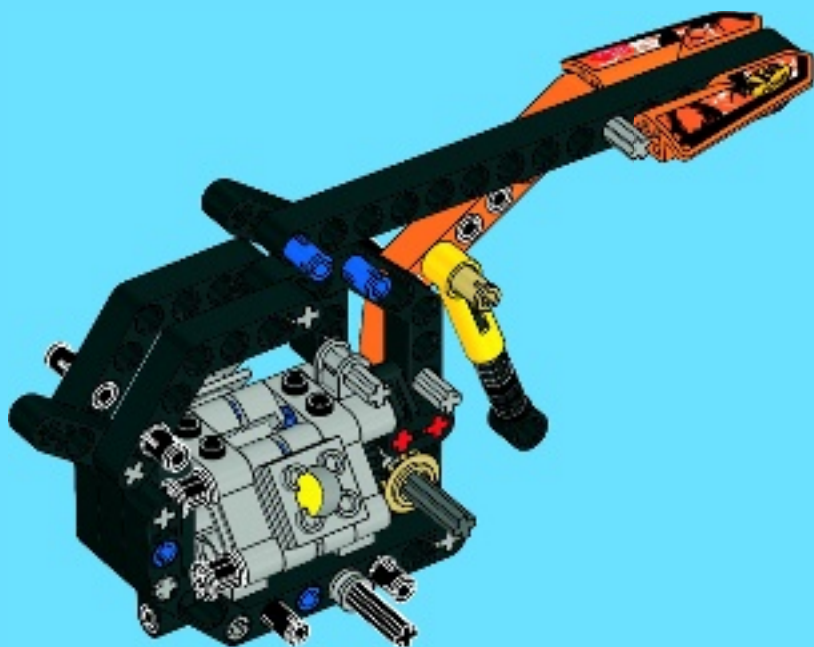



1x



1x

# 18

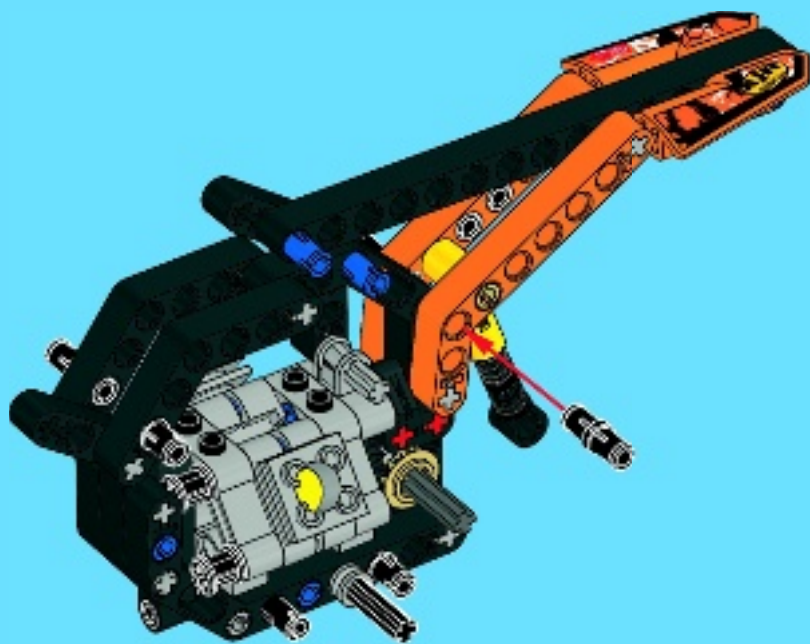



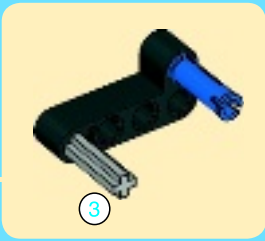
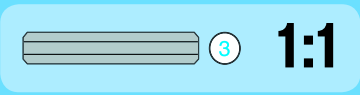

19

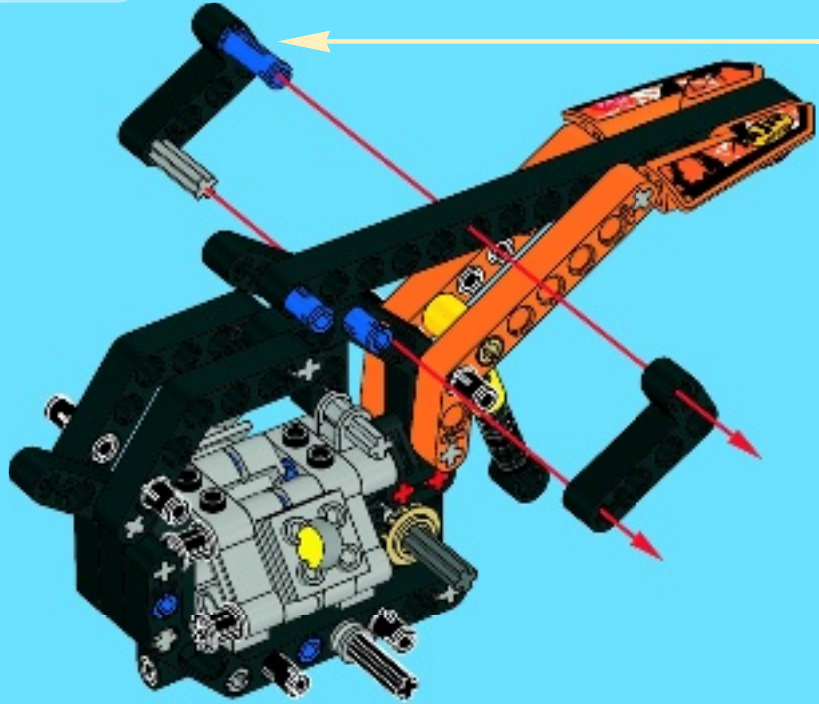



2x



2x

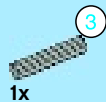

1x

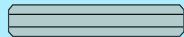

3

1:1

# 20

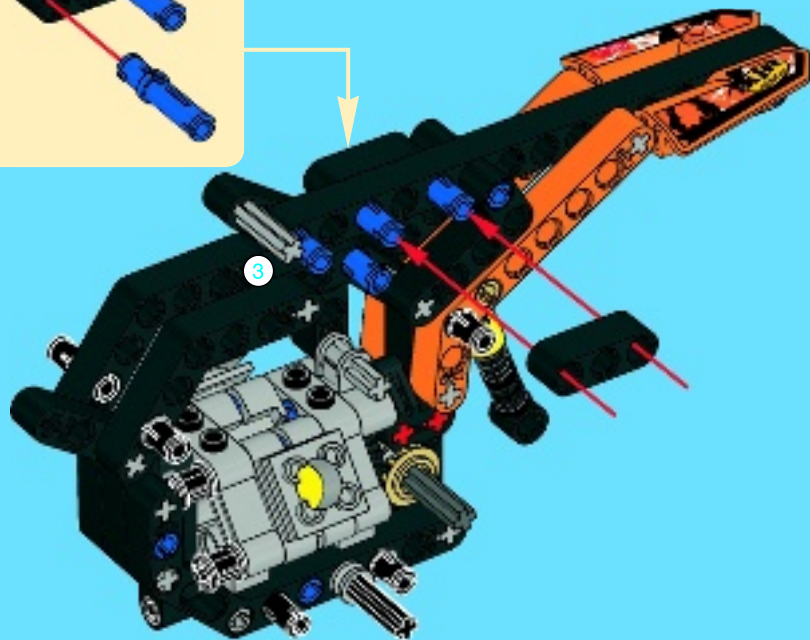
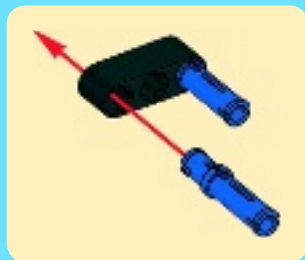

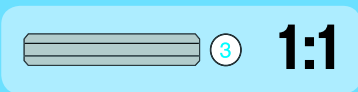

21

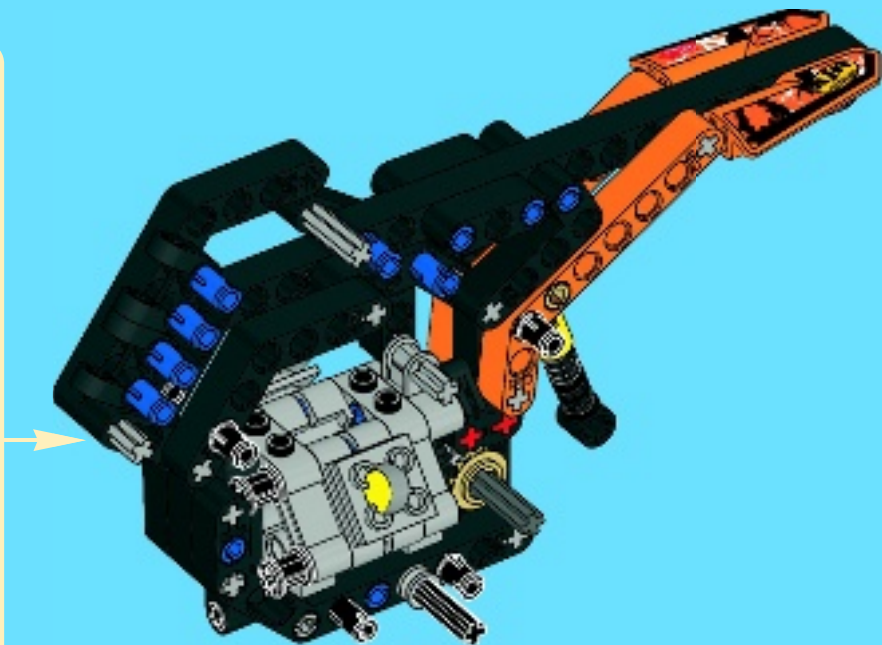
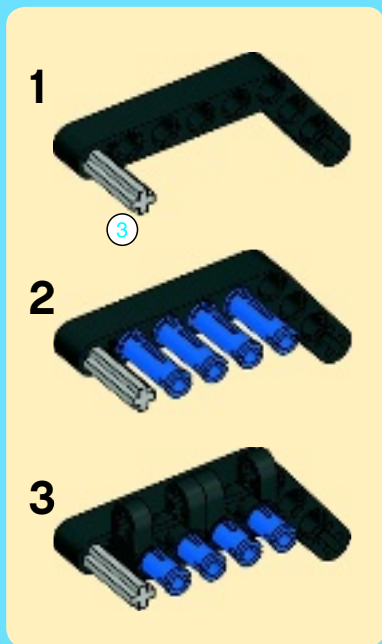

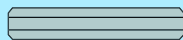
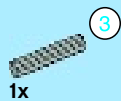

3

1:1

22

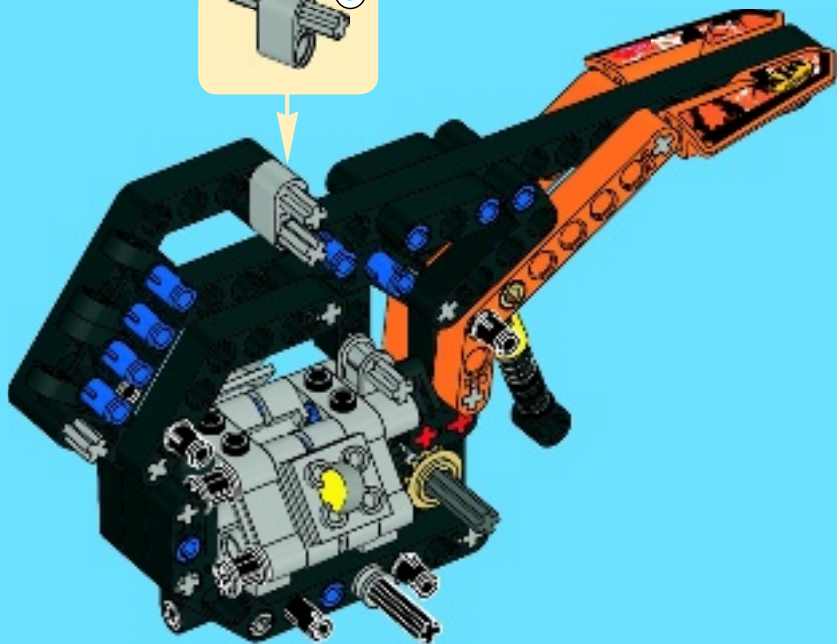
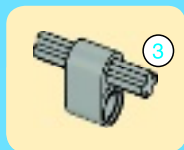



23

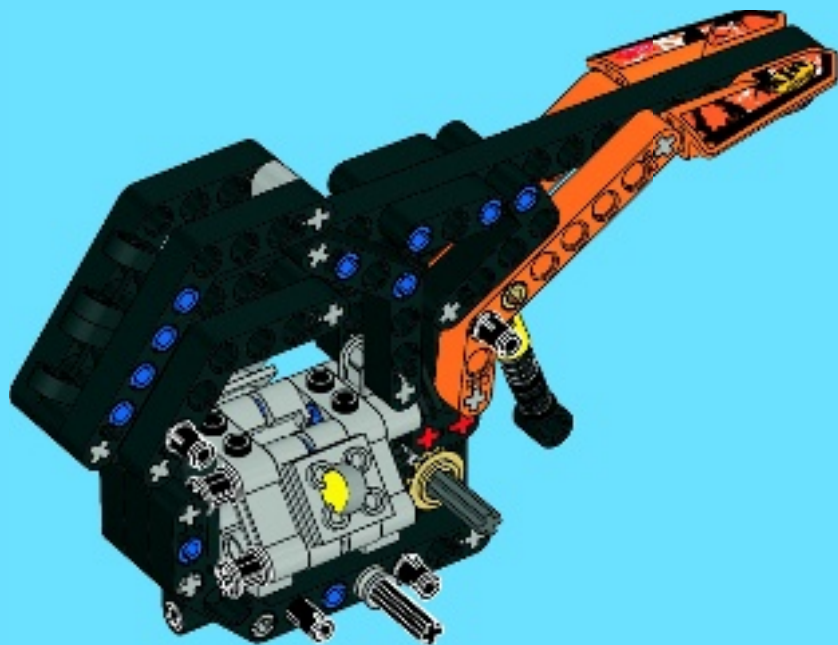



1x

24

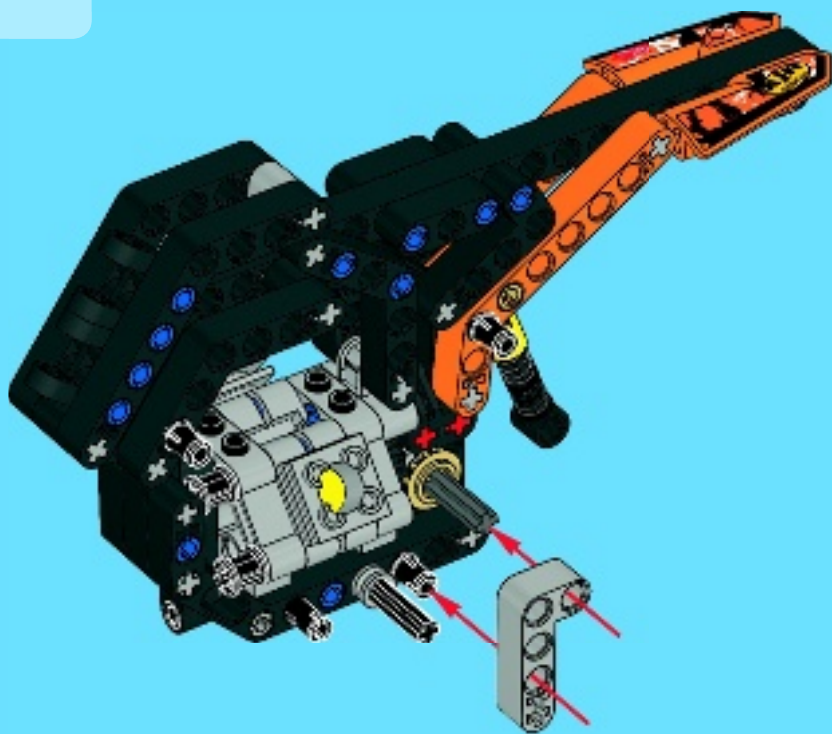

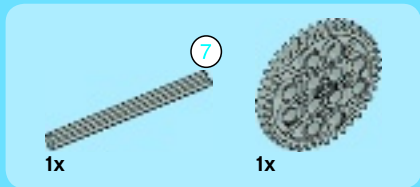
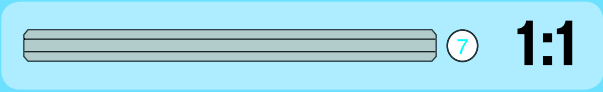
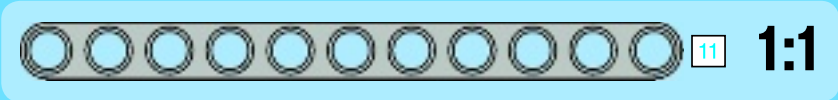

1

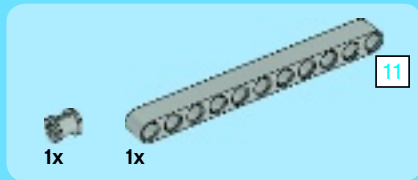

2

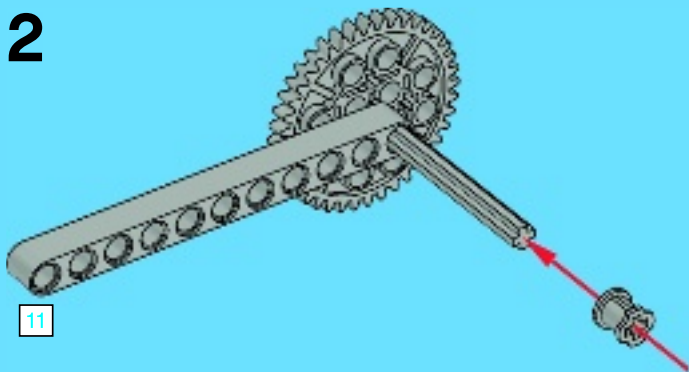

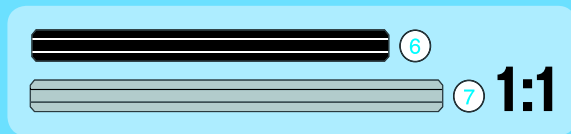
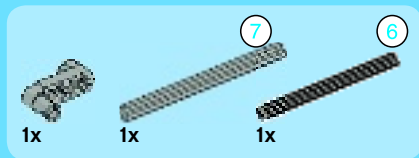

3

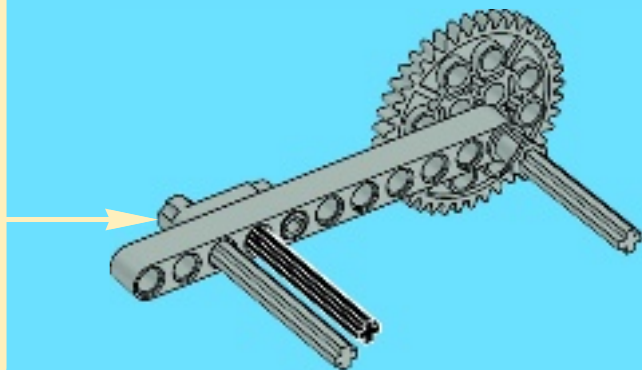
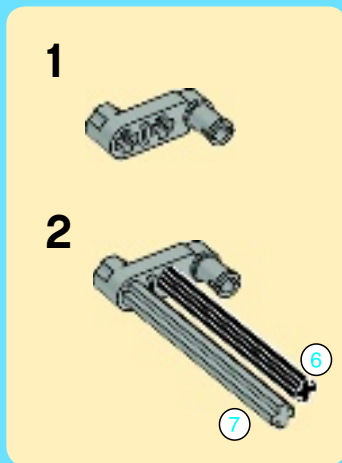





1x



1x

4

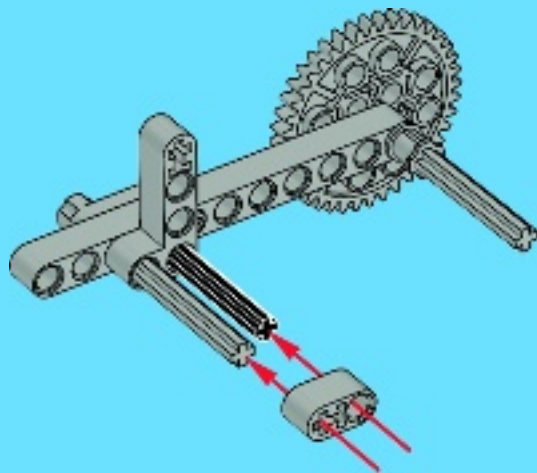

1x



1x

5

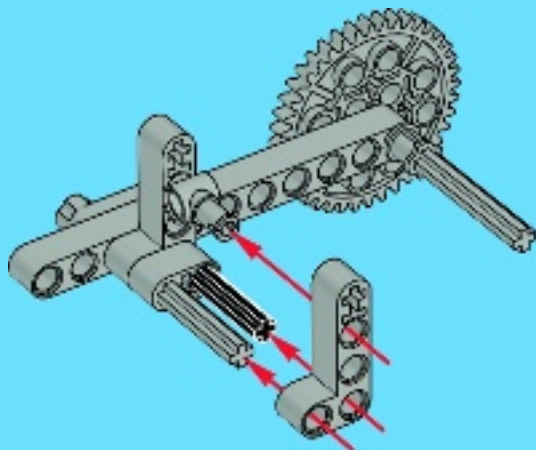



6

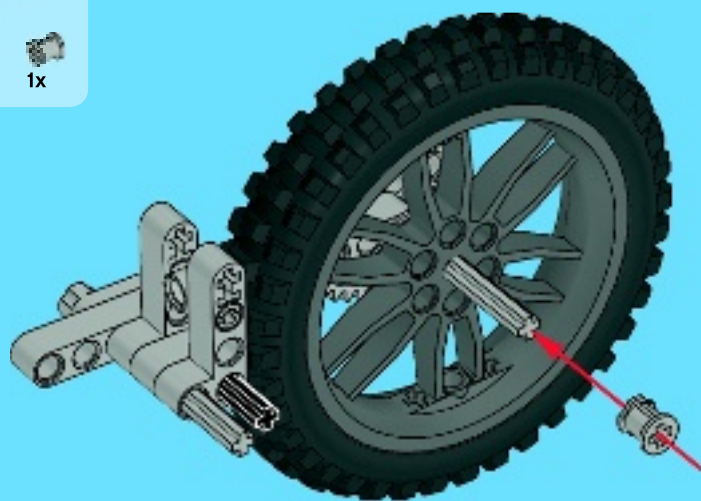

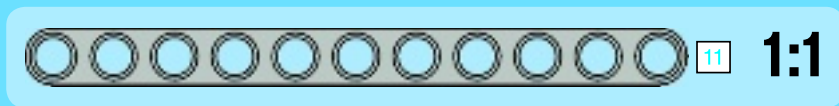
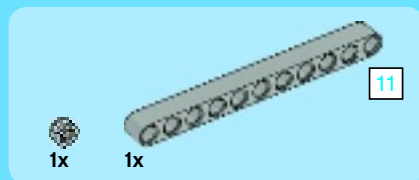

7

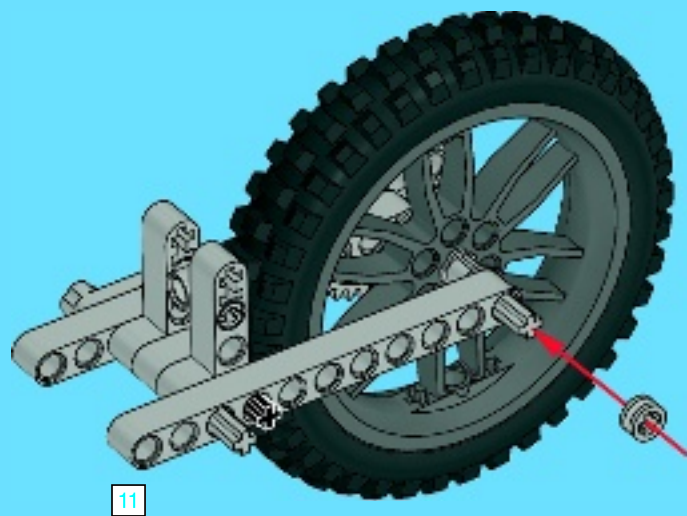



1x

8

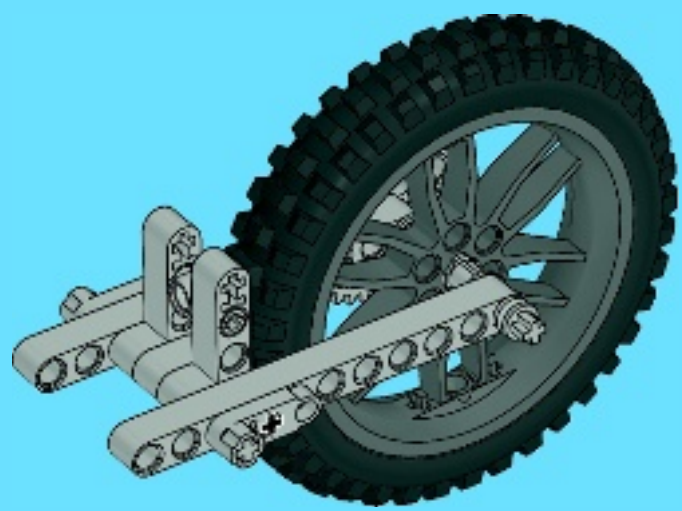

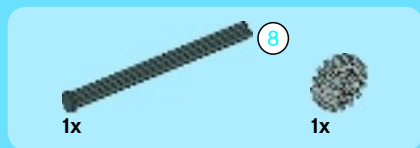

25

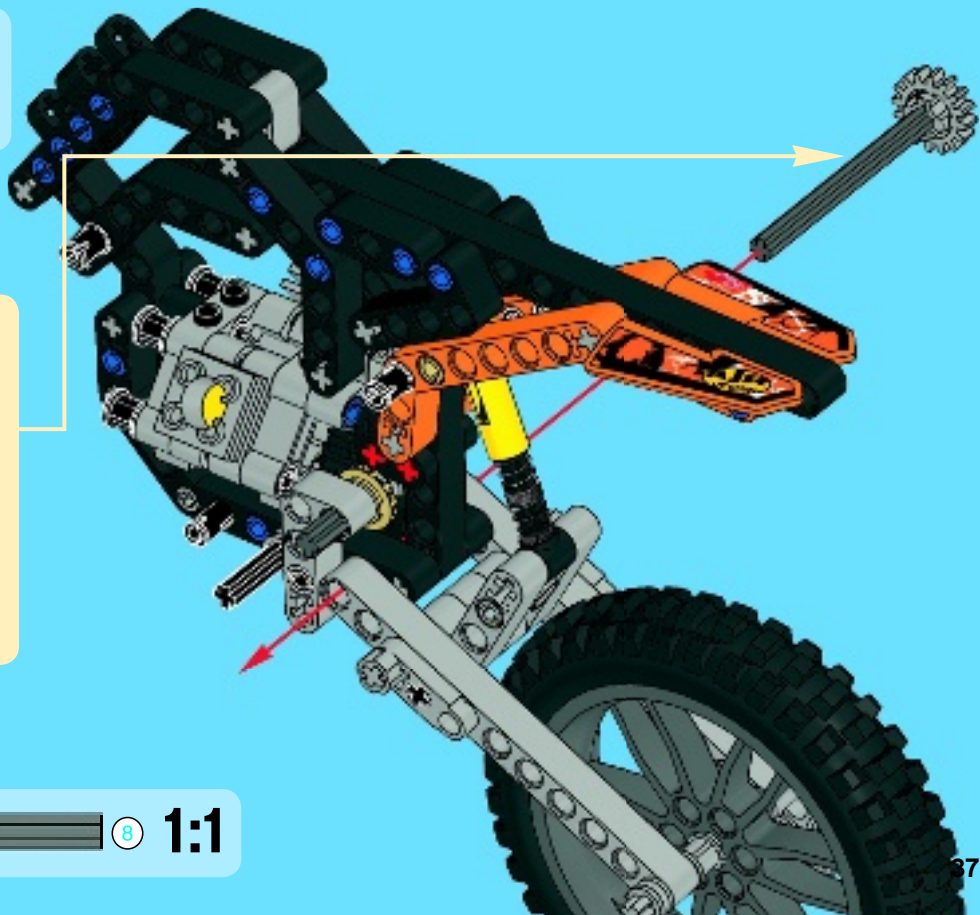
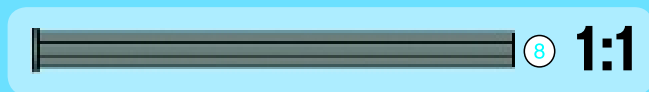
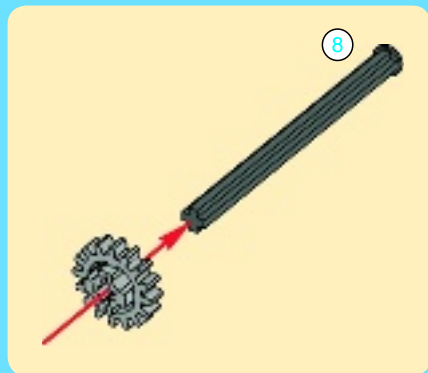



1x



2x

# 26



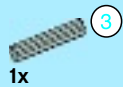

1x

# 27



3

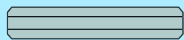

3

# 1:1

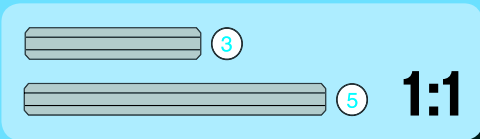
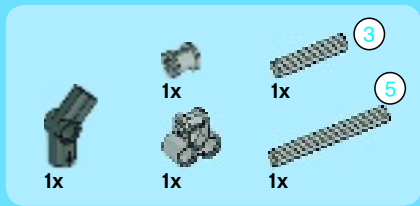

28

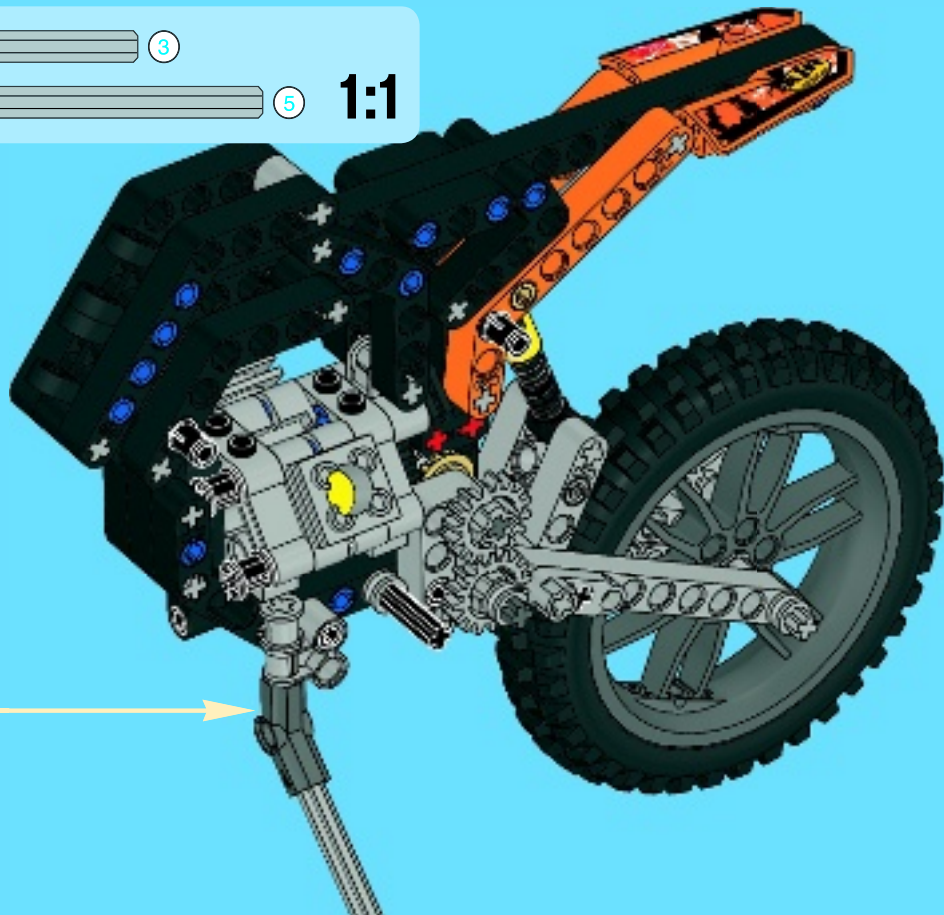
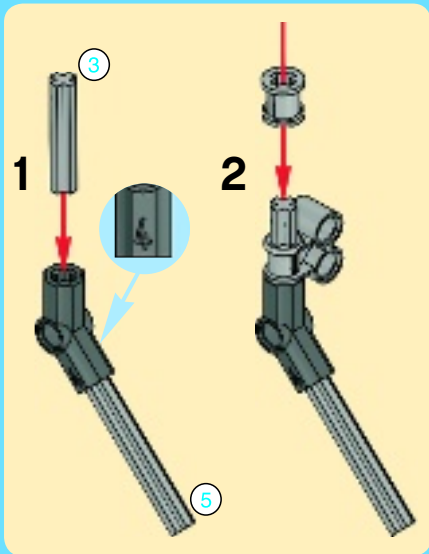





1x



1x

# 29

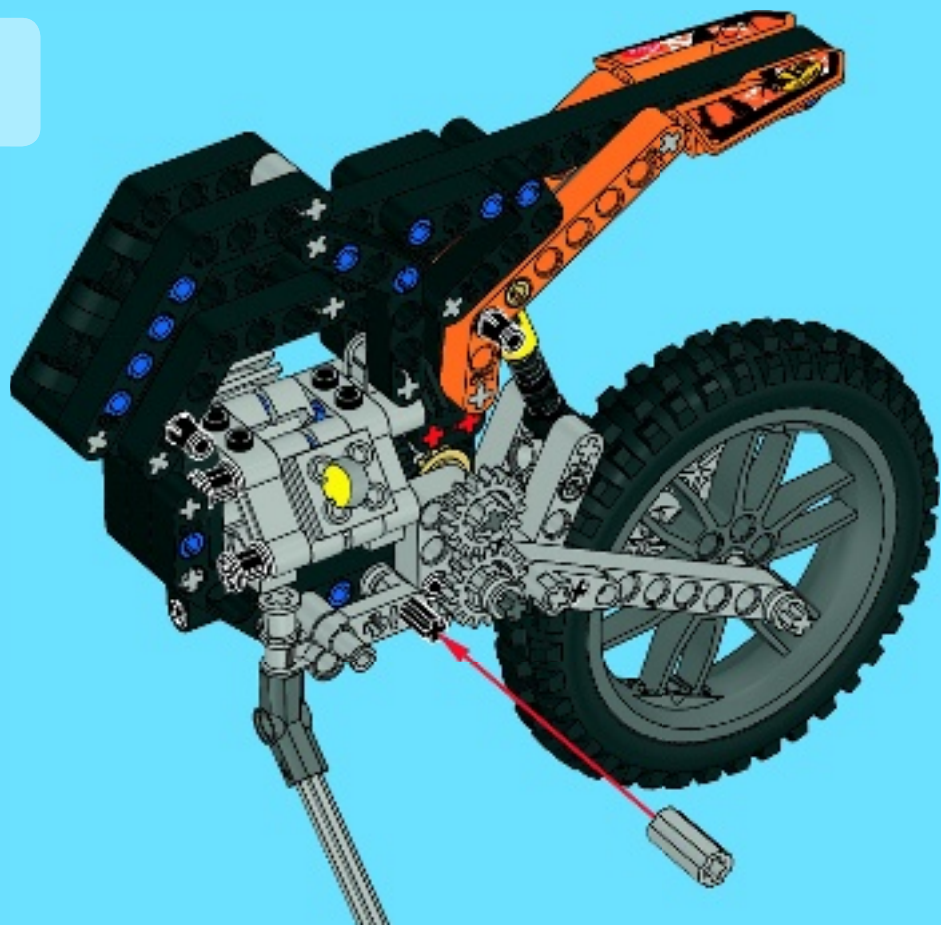



39x

30

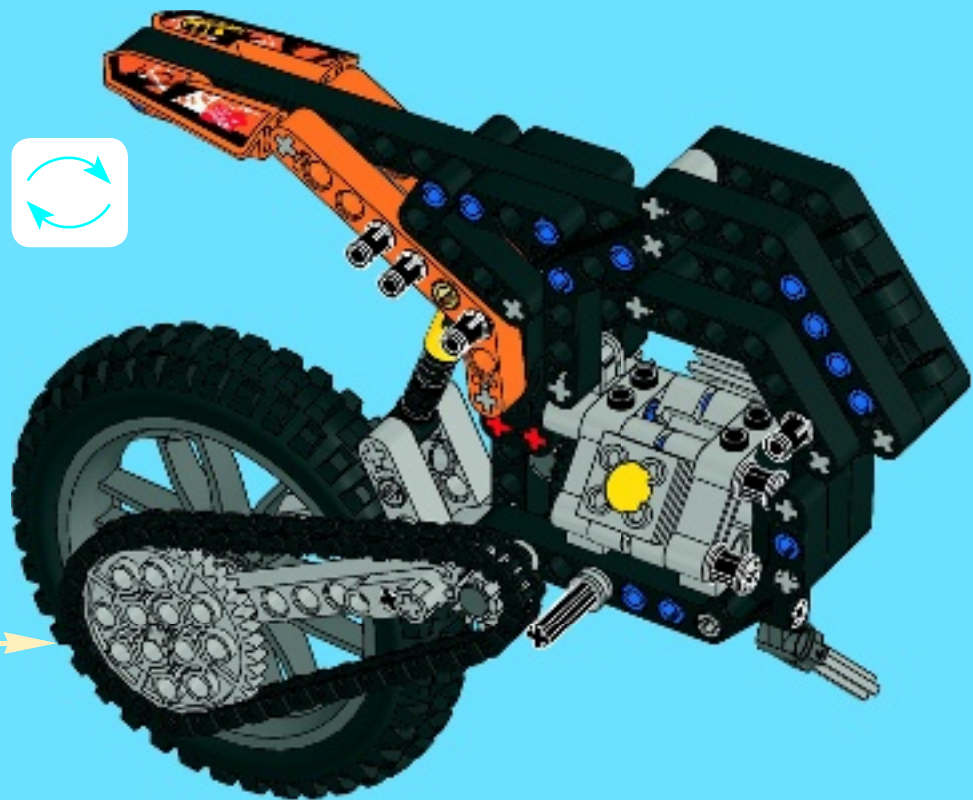

39x



1x



1x

# 31

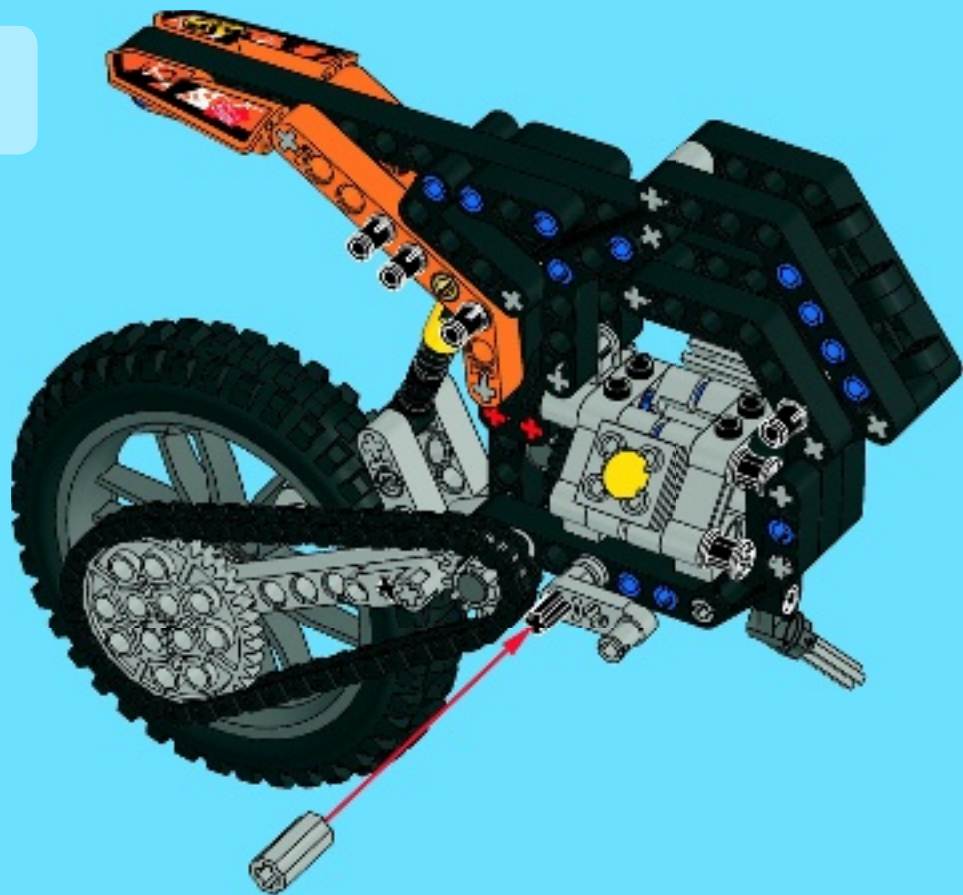

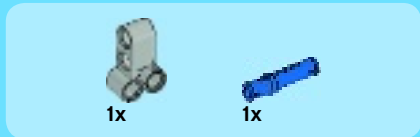
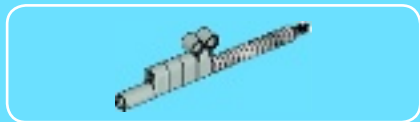

1

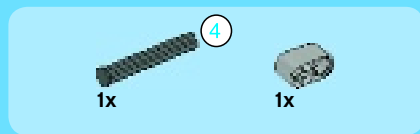
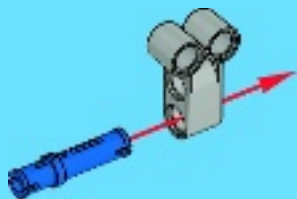

2

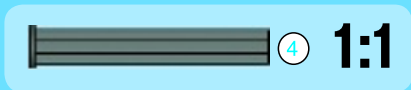
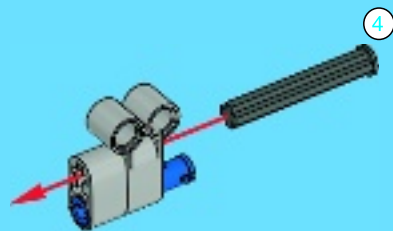



1x



1x

**3**

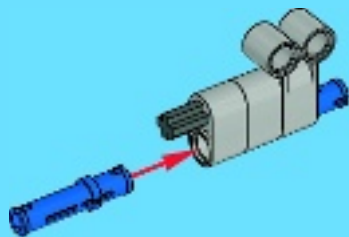

1x

**4**

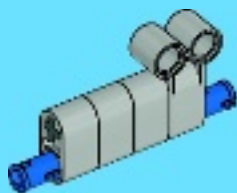

1x



1x

**5**

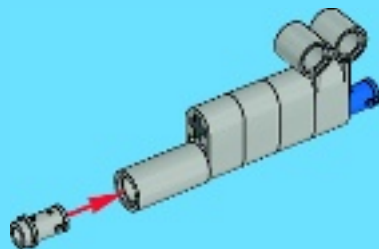



1x



1x

6

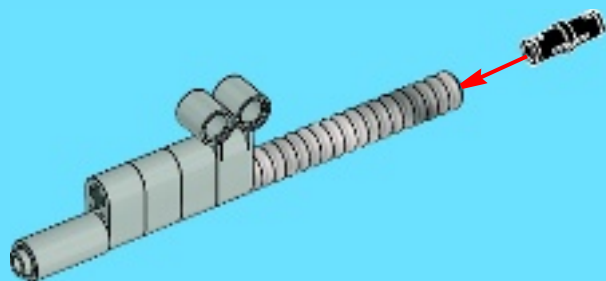

32

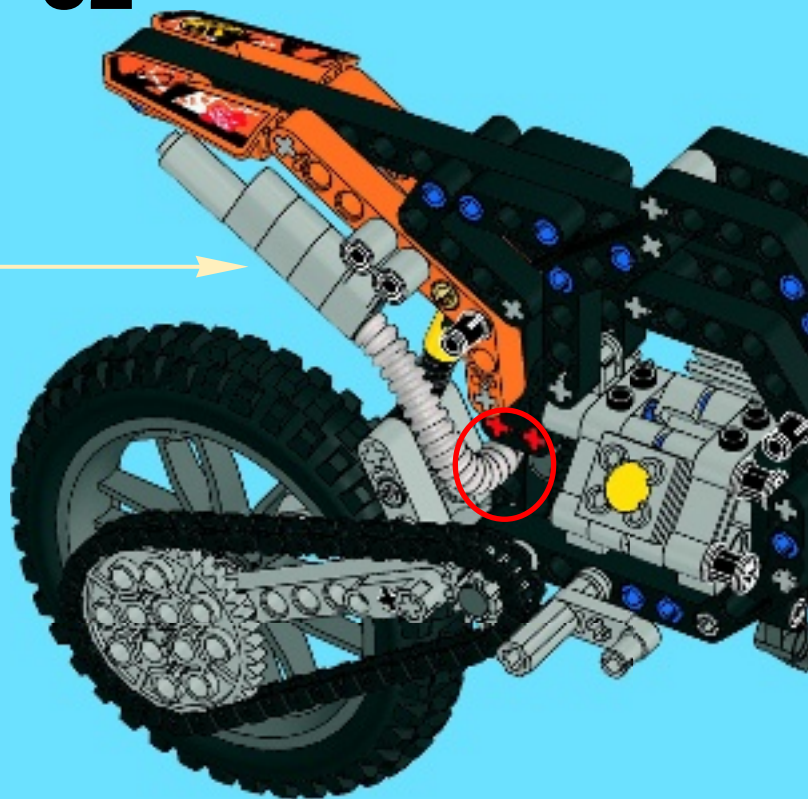

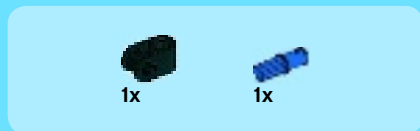

1

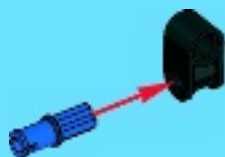

2

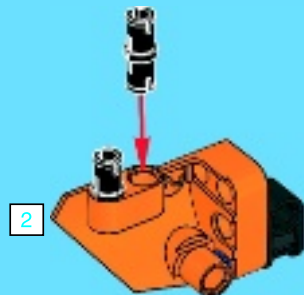

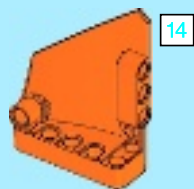

1x

3

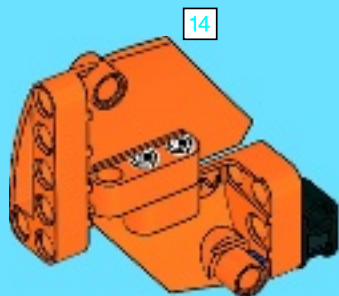

1x



1x

4

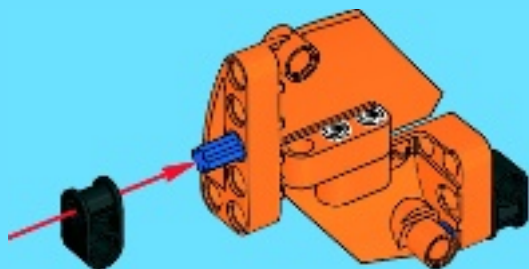



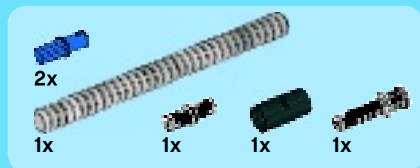

5

1



2



3

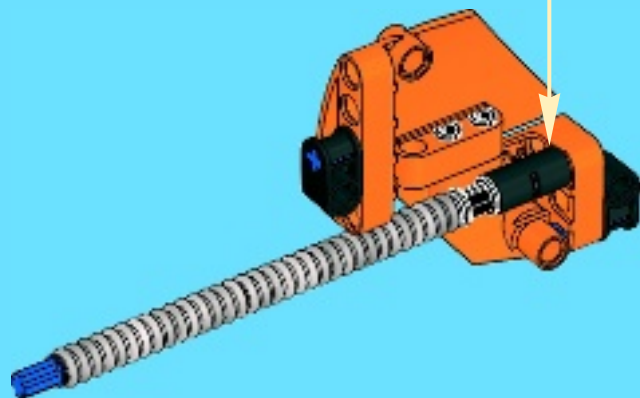



6

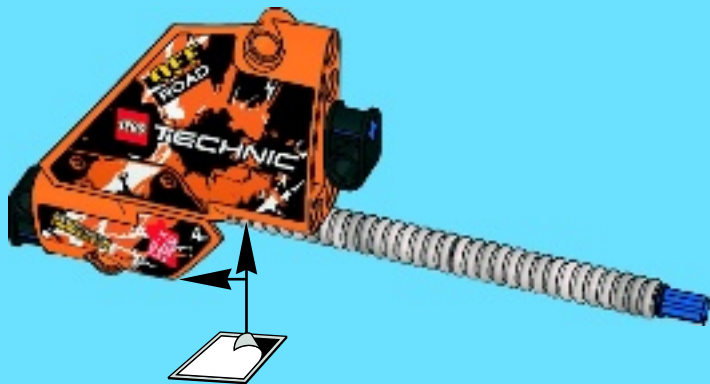

33

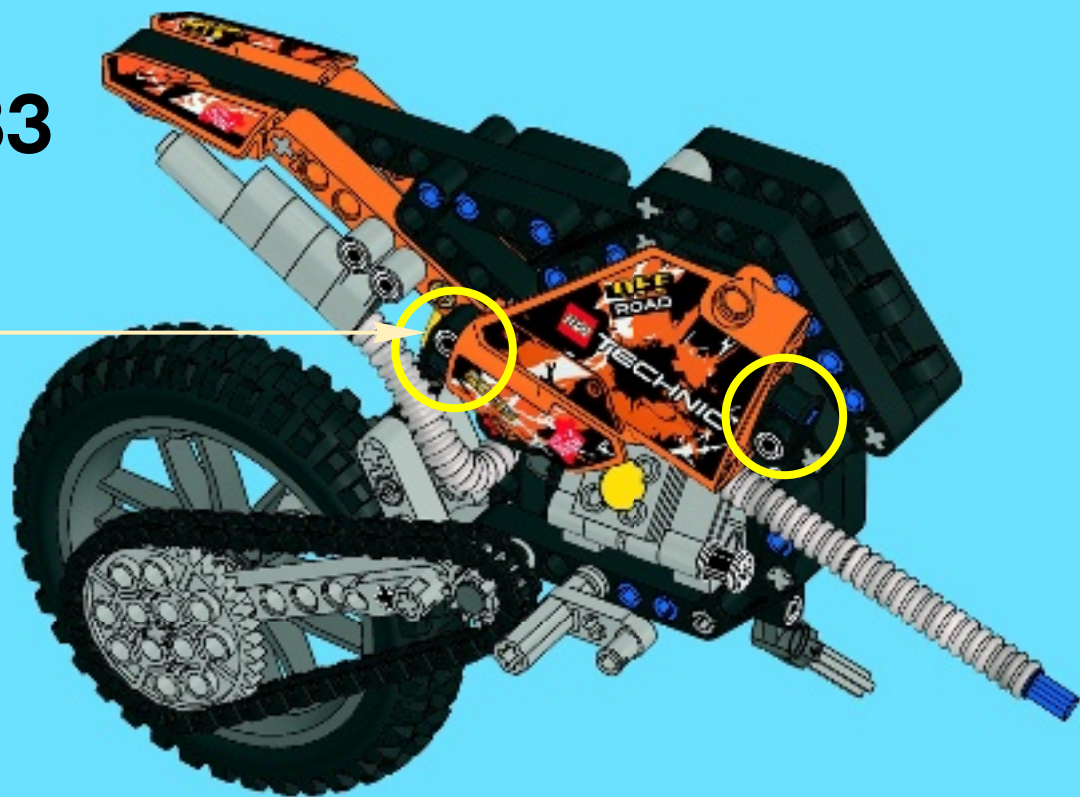



34

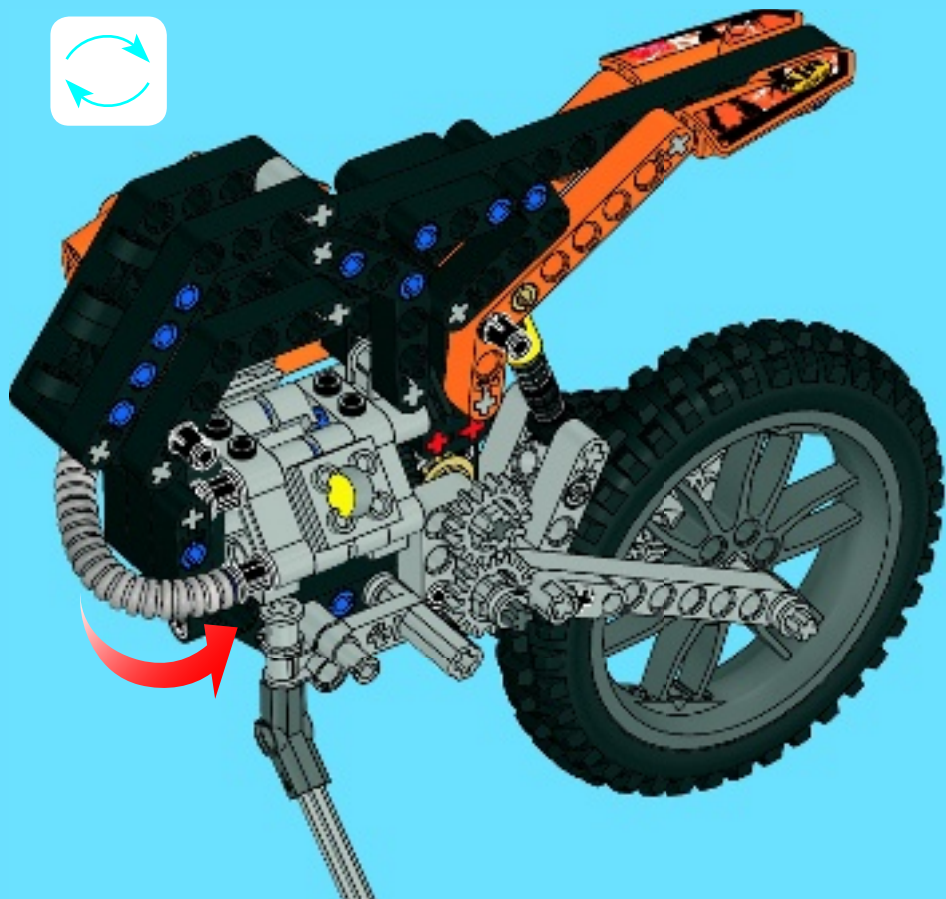



1x



1x

1



2x

1x



1

2

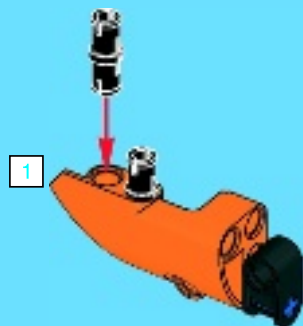

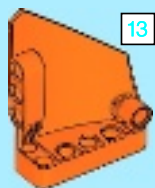

13

1x

3

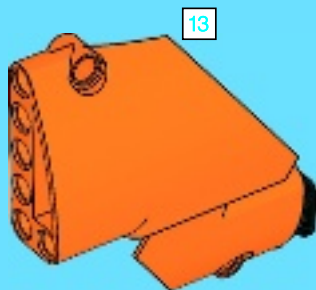

13



1x



1x

4

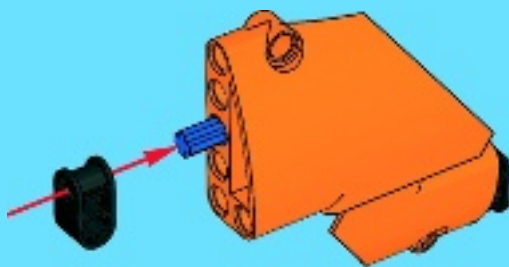

5



35



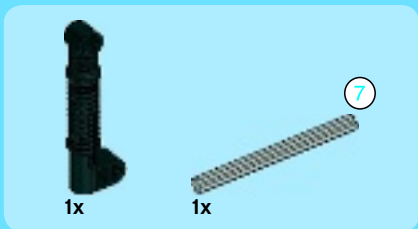
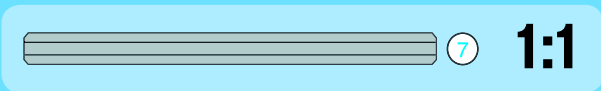

1

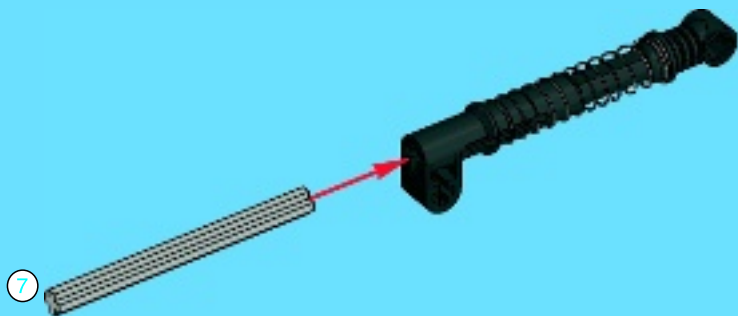





1x

2



2x

3



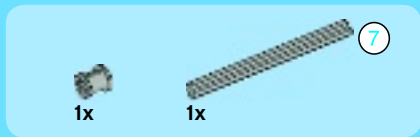

4

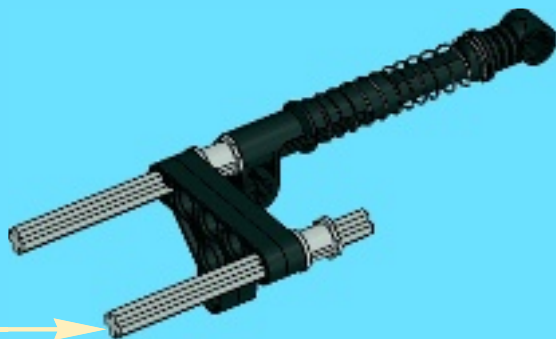
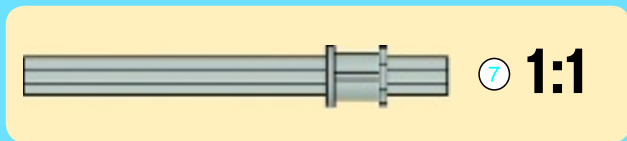

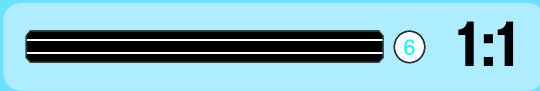
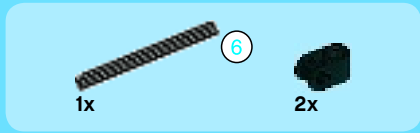

5

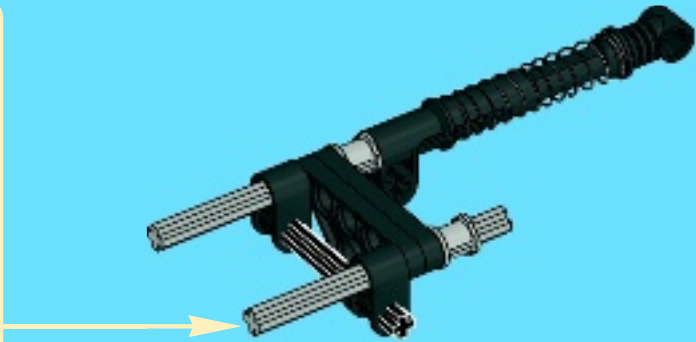
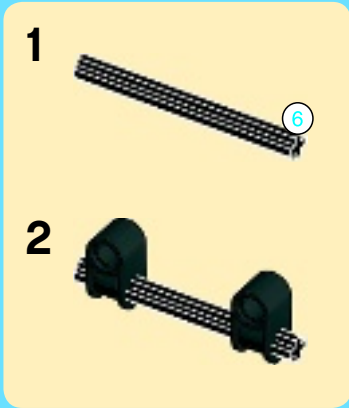

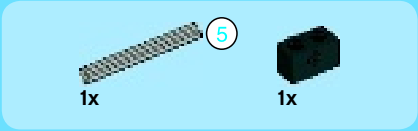

6

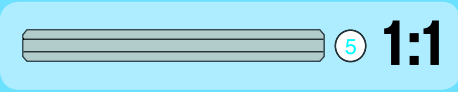
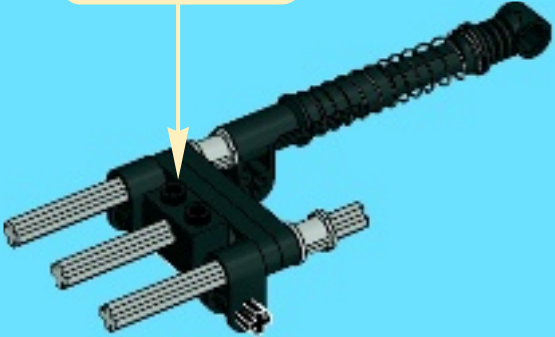
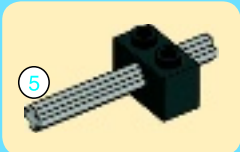

7

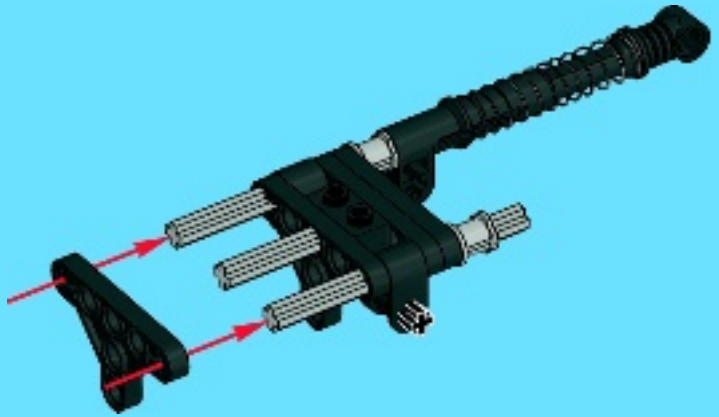



2x

8

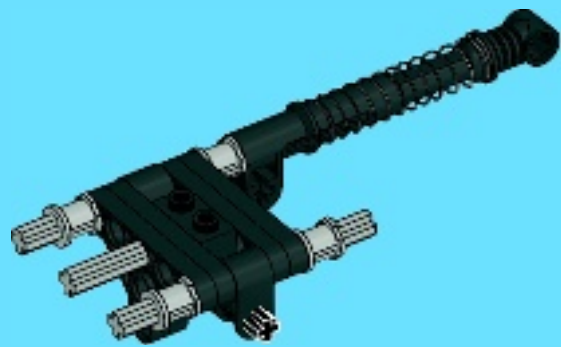

2x

9

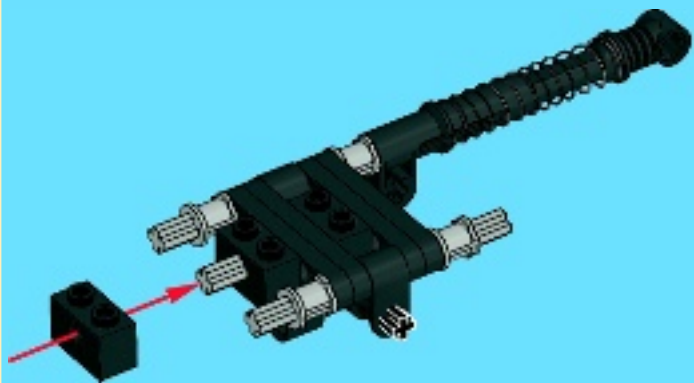

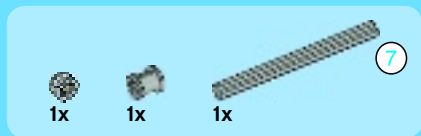

10

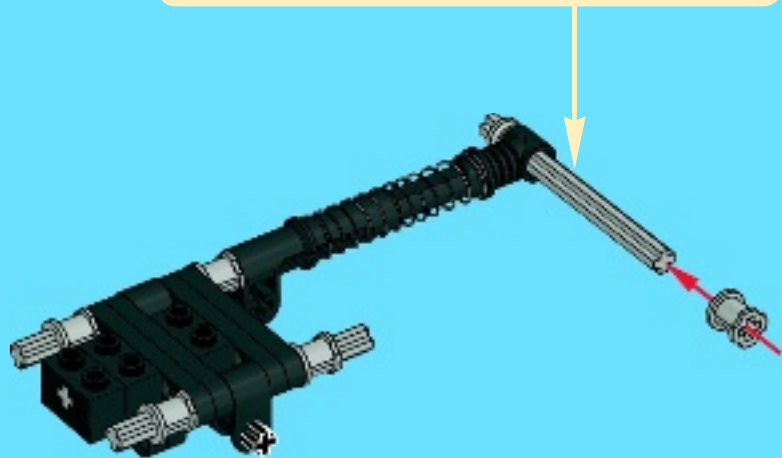



11





1x



1x

12







2x



2x

# 13



2x





36





1x

1



1x



1x

2



1x

3





2x

4



1x

5

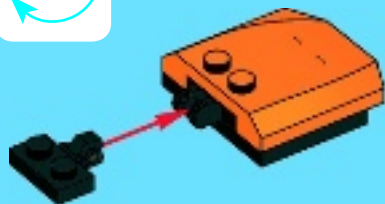



1x

6



1x

7



8

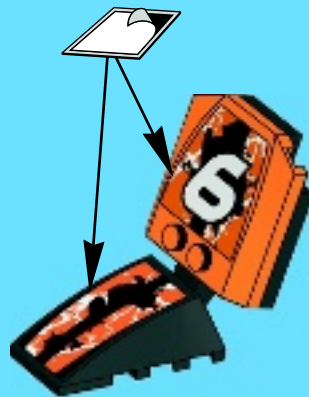

37



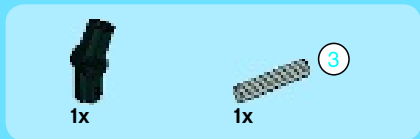
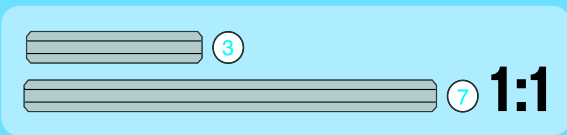

1

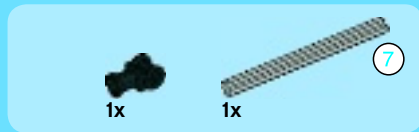

2

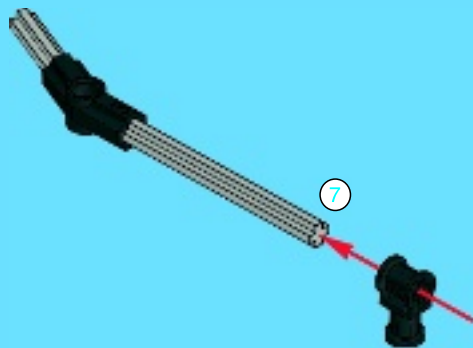



1x



1x

3



1x



1x

4







1x



1x

5



2x

6



38







# TECHNIC



42011



42004



42010



42002



42007





# TECHNIC

42010



**PULL  
BACK**

**RÉTRO-  
FRICTION**

42011





3



[www.LEGOclub.com/Max](http://www.LEGOclub.com/Max)

**LEGO** club™

**FREE\*! GRATIS! GRATUIT!**

\*Paid subscription in Australia and New Zealand.  
\*Abonnement payant en Australie et Nouvelle-Zélande.

©2013 The LEGO Group.





# WIN!

Go to [www.LEGOsurvey.com/product](http://www.LEGOsurvey.com/product) to fill out a survey for a chance to win a cool LEGO® Product.

No purchase necessary.

Open to all residents where not prohibited.



## [www.LEGOsurvey.com/product](http://www.LEGOsurvey.com/product)

### GEWINNE!

Nimm an der Umfrage auf [www.LEGOsurvey.com/product](http://www.LEGOsurvey.com/product) teil und hab die Chance ein cooles LEGO® Produkt zu gewinnen!

Die Teilnahme am Gewinnspiel führt zu keinerlei Kaufverpflichtungen. Teilnahme in allen nicht ausgeschlossenen Ländern möglich.

### WIN!

Ga naar [www.LEGOsurvey.com/product](http://www.LEGOsurvey.com/product), vul een enquêteformulier in en maak kans op een cool LEGO® product.

Geen aankoopverplichting. Iedereen mag deelnemen, uitgezonderd ingezetenden van landen waar een enquêteverbod geldt.

### GAGNE!

Visite [www.LEGOsurvey.com/product](http://www.LEGOsurvey.com/product) pour répondre à un questionnaire et avoir une chance de gagner un produit LEGO® très cool!

Aucune obligation d'achat. Ouvert à tous les résidents des pays autorisés.

### 当てよう!

[www.LEGOsurvey.com/product](http://www.LEGOsurvey.com/product) にアクセスして、アンケートにご記入ください。当選者にはレゴ®製品を差し上げます。

お買い上げの必要はありません。禁止されていない限り、すべての皆様にご利用いただけます。



LEGO.com

6042851 / 6042853

LEGO and the LEGO logo are trademarks of the/son des marques de commerce de/son marcas registradas de LEGO Group. ©2013 The LEGO Group.



**LEGO**

**TECHNIC**

42007



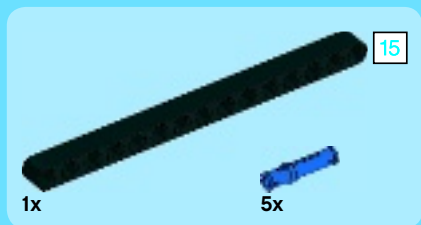
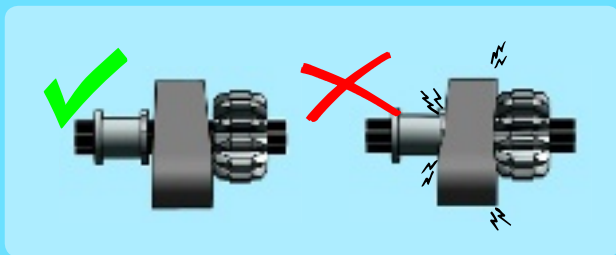

1

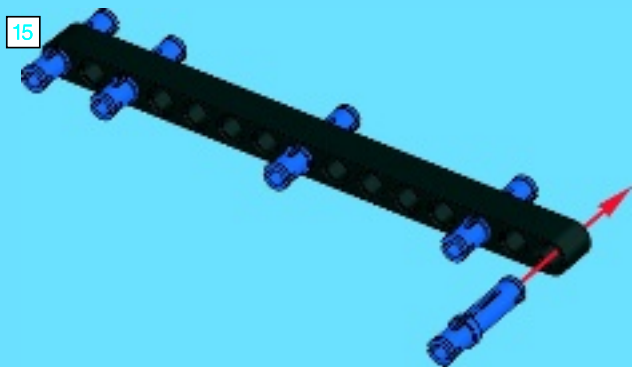

2

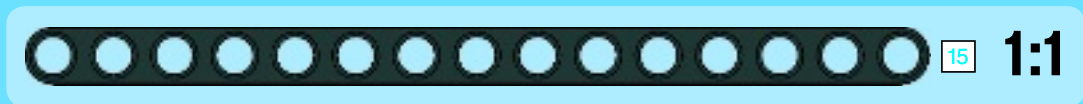

1:1

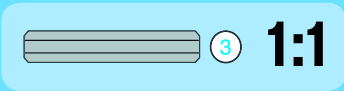

2

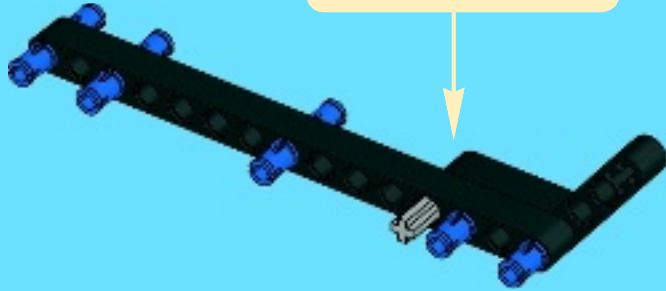
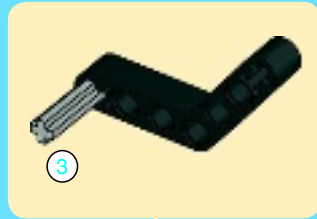

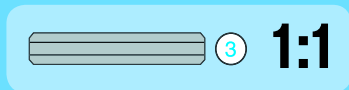
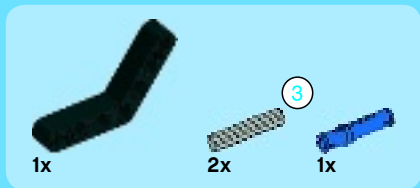

3

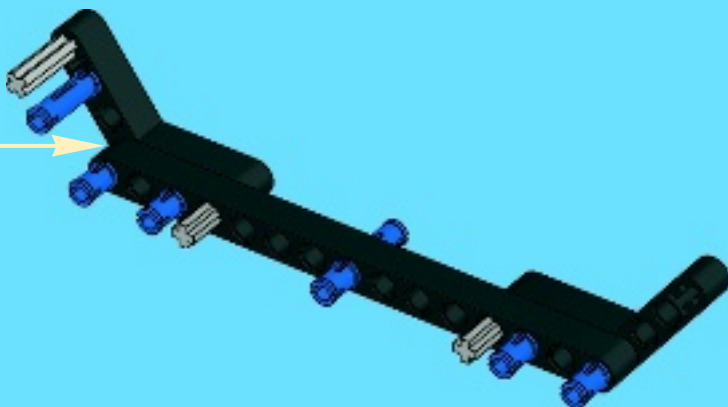
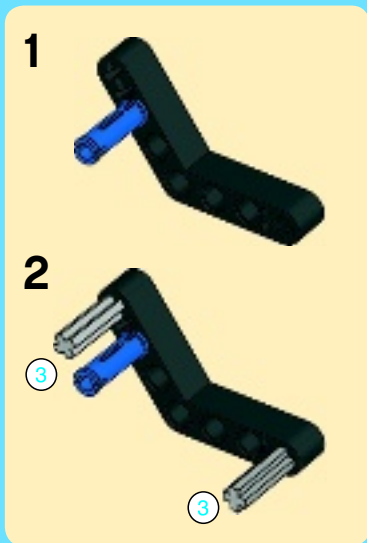



1x



1x

4

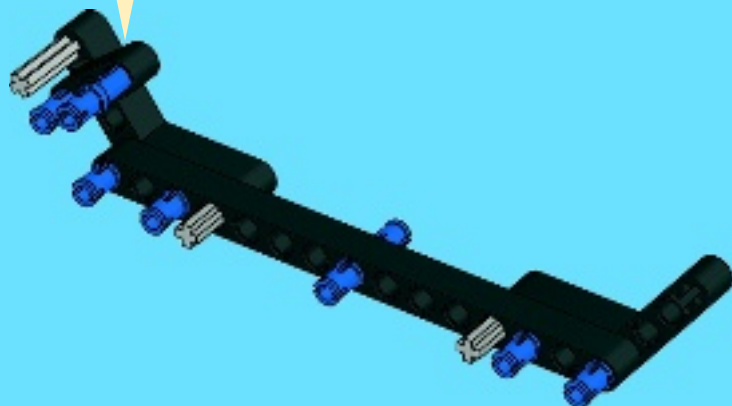

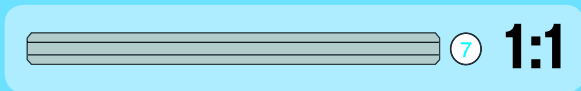
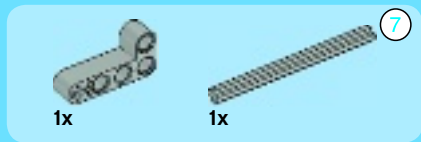

5

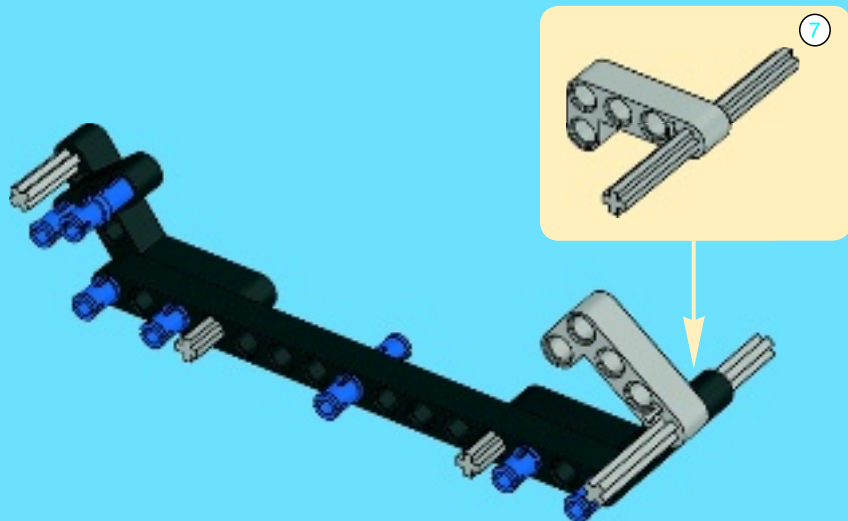

6



2x



1x

3

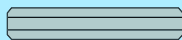

3

1:1

6

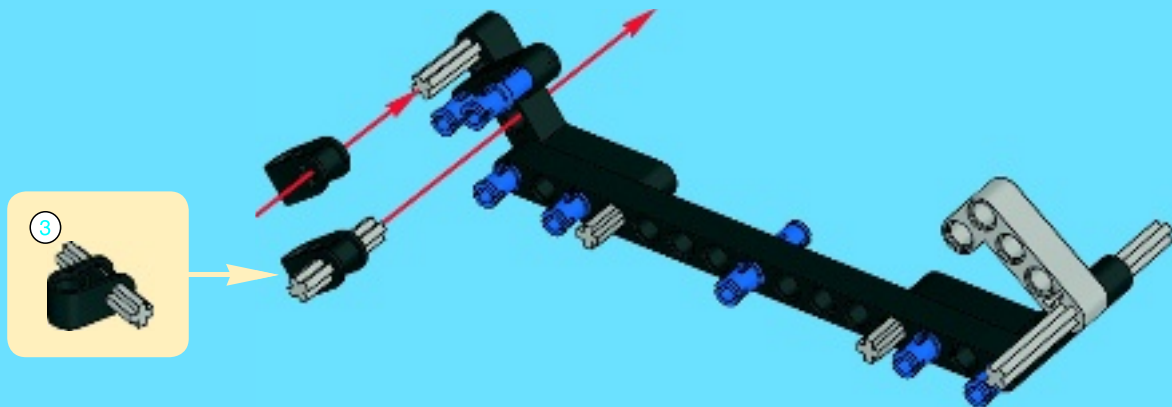



2x

7

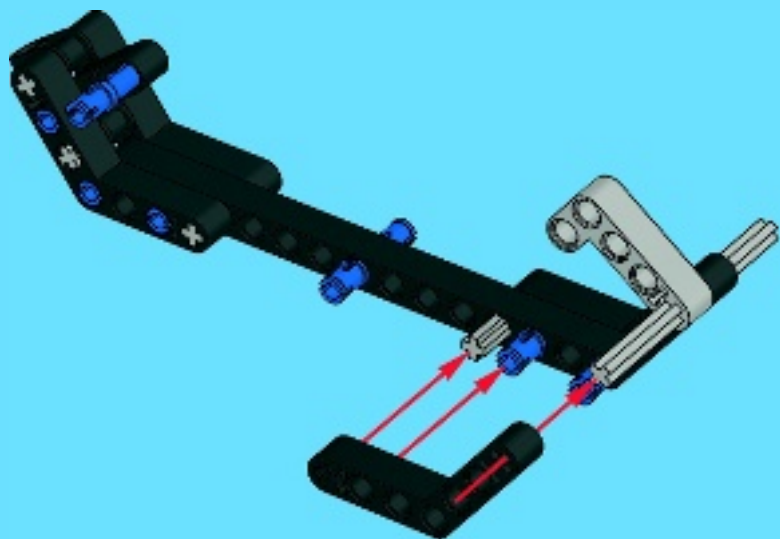

8





1x



1x



1x

# 8

1



2

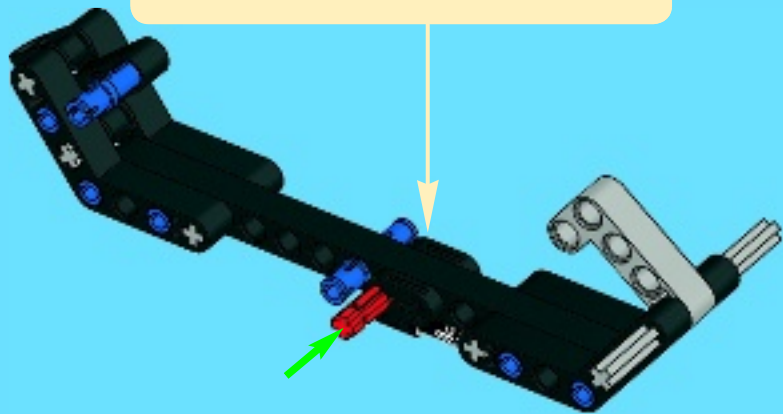



4x



1x

1



1x

2





1x



2x



1x

3



1x

# 3

## 1

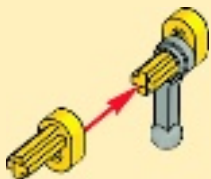

## 2

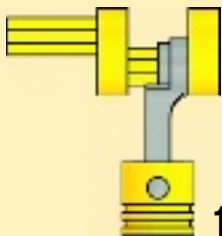

1:1

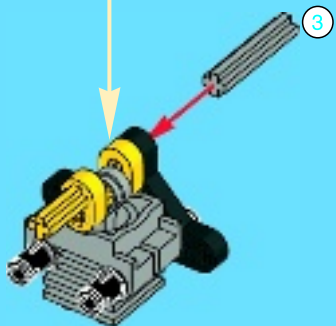

3

# 4



1x

3



1x



3

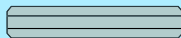

3

1:1

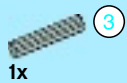

9

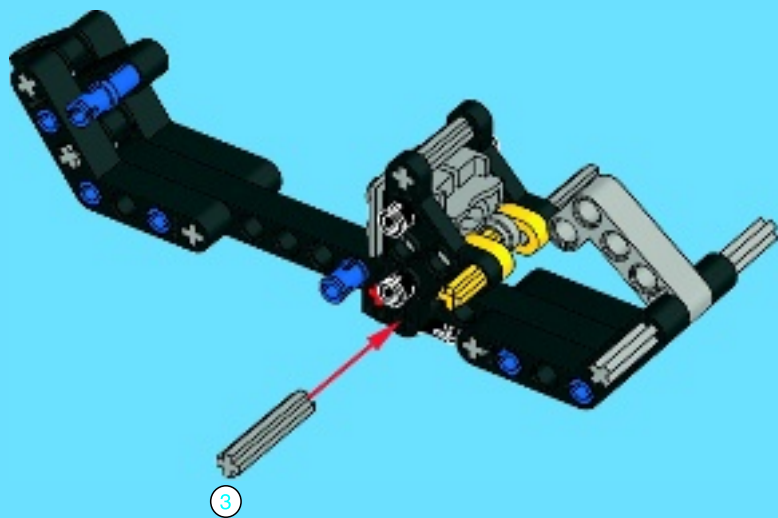



# 10

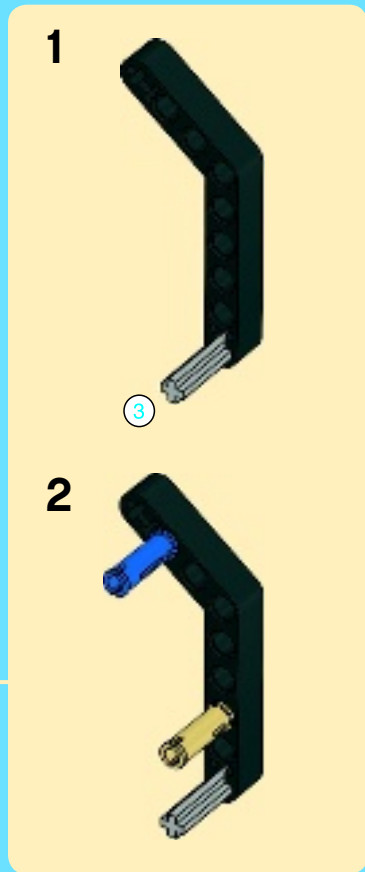
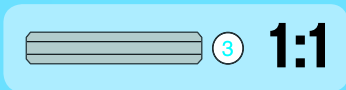
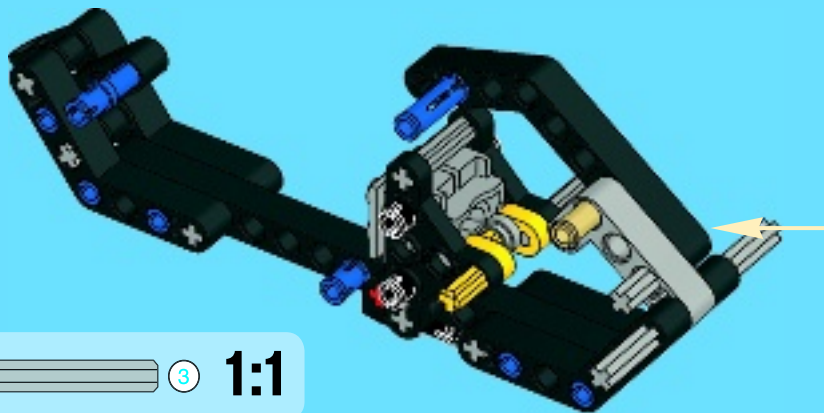

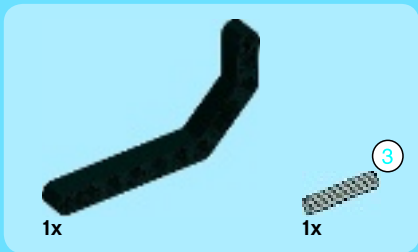

1

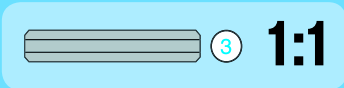

14



2



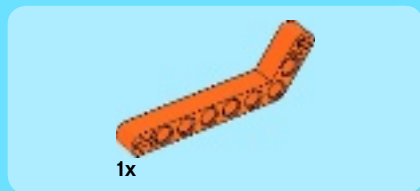

3

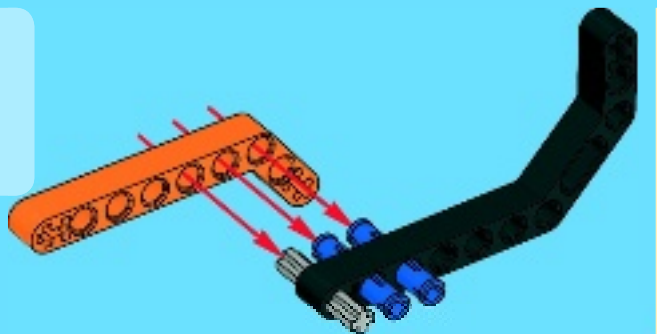

11

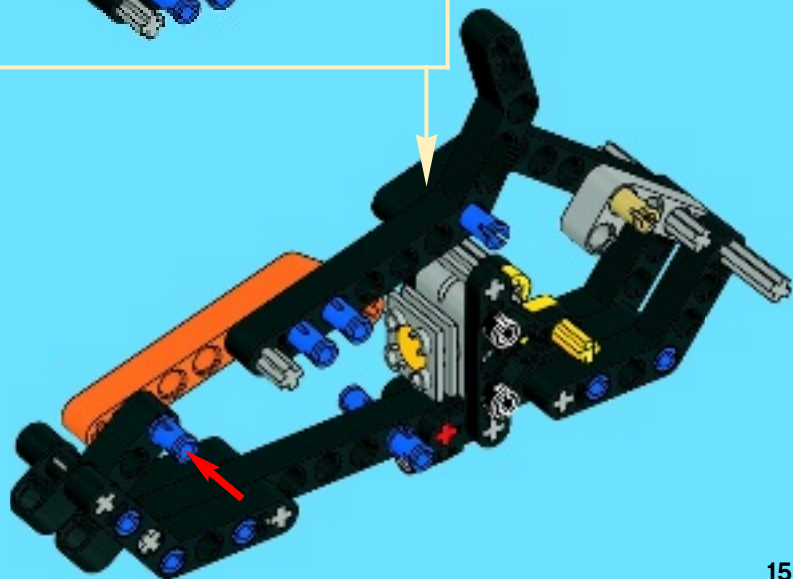

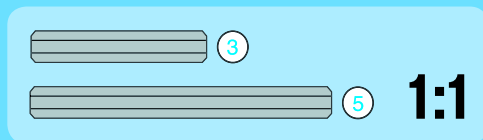
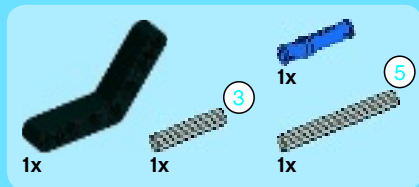

# 12

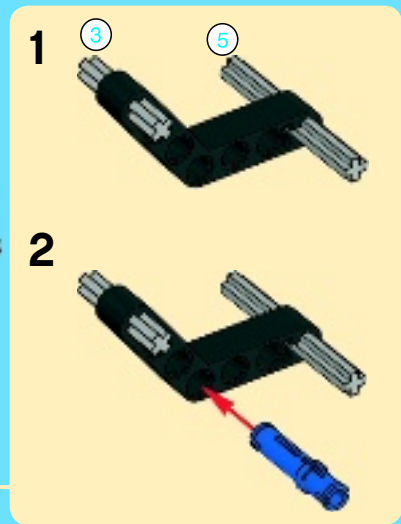
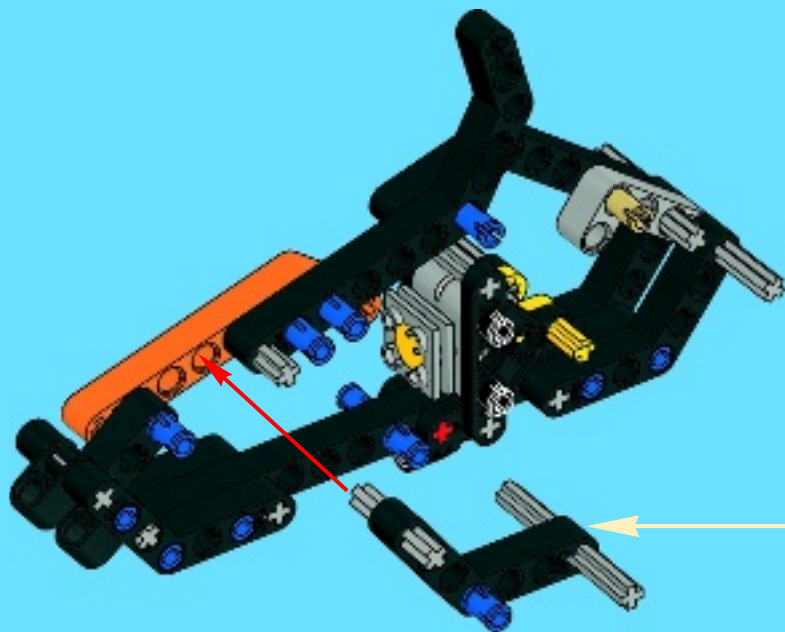





2x

# 13

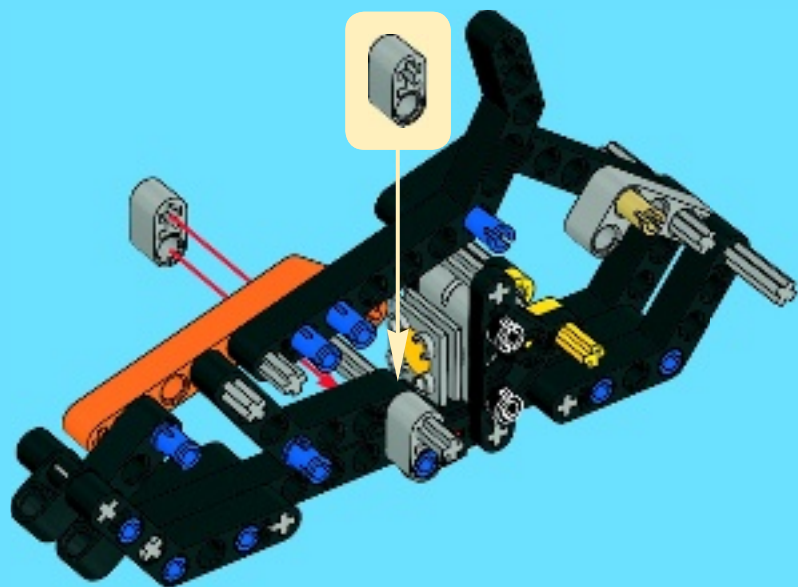

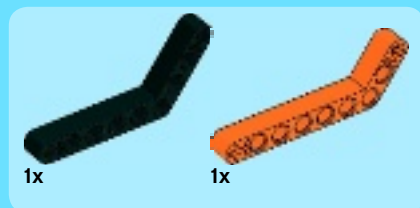

14

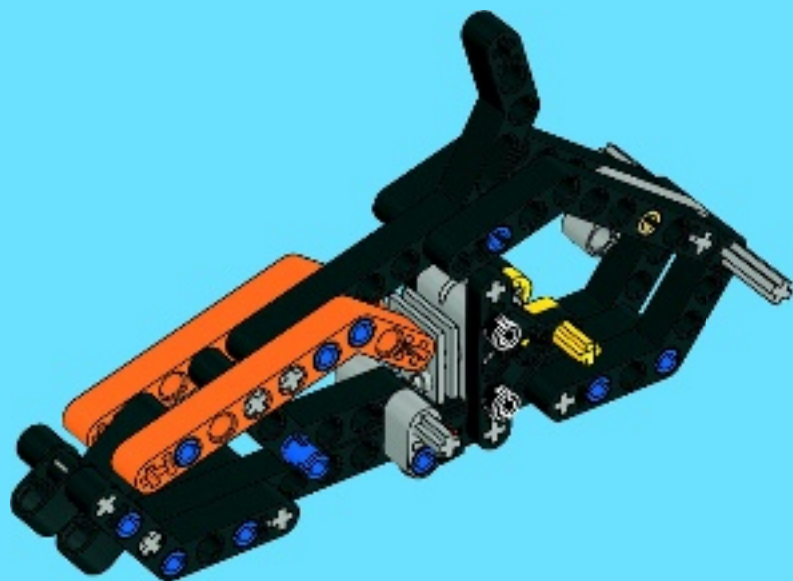

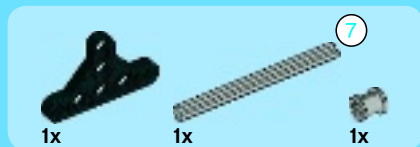

15

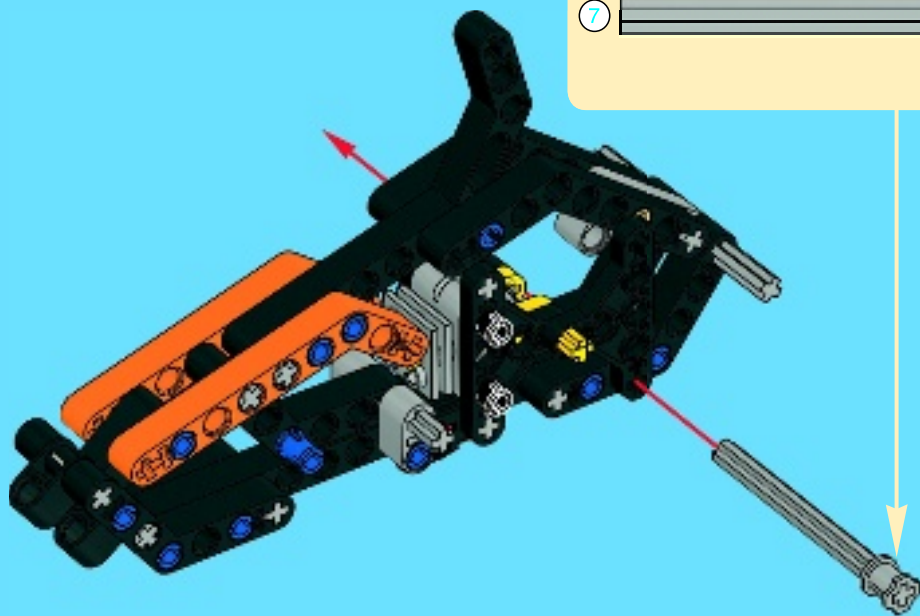
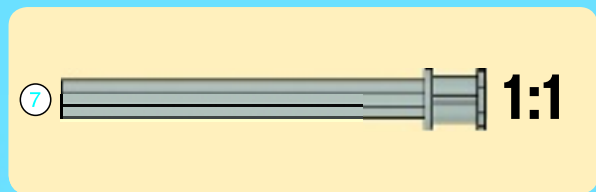



1x



1x

# 16

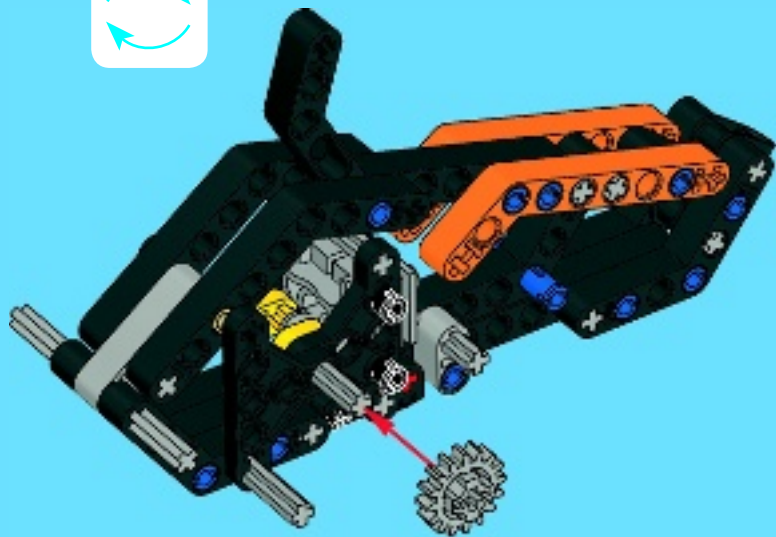

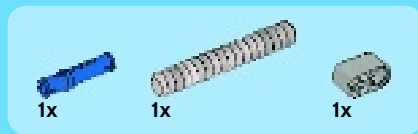

17

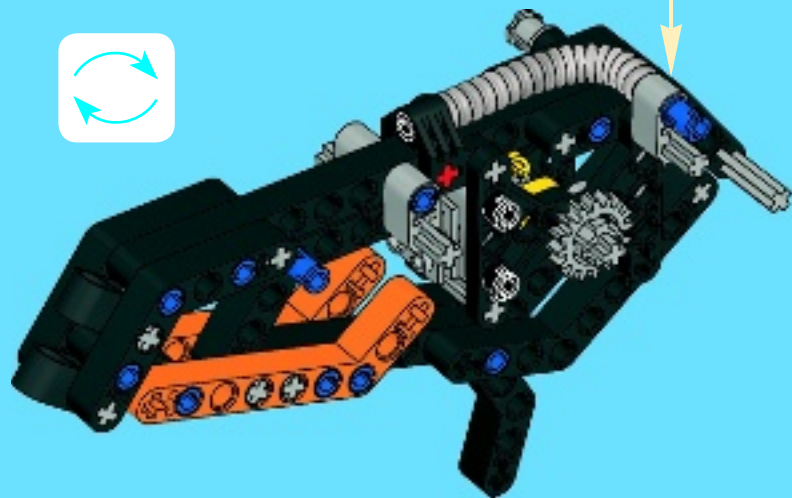
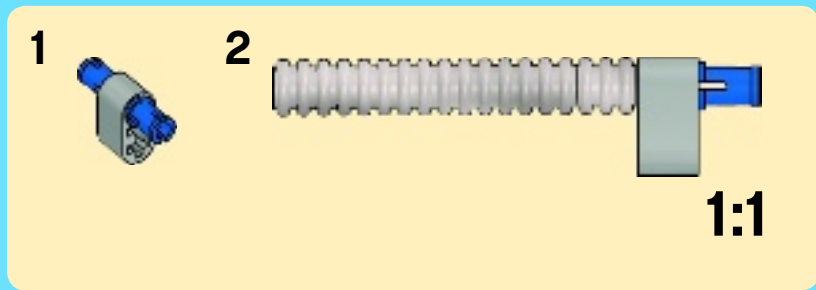

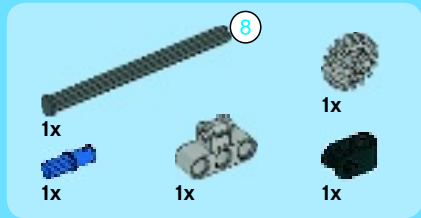

18

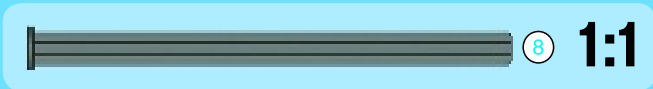
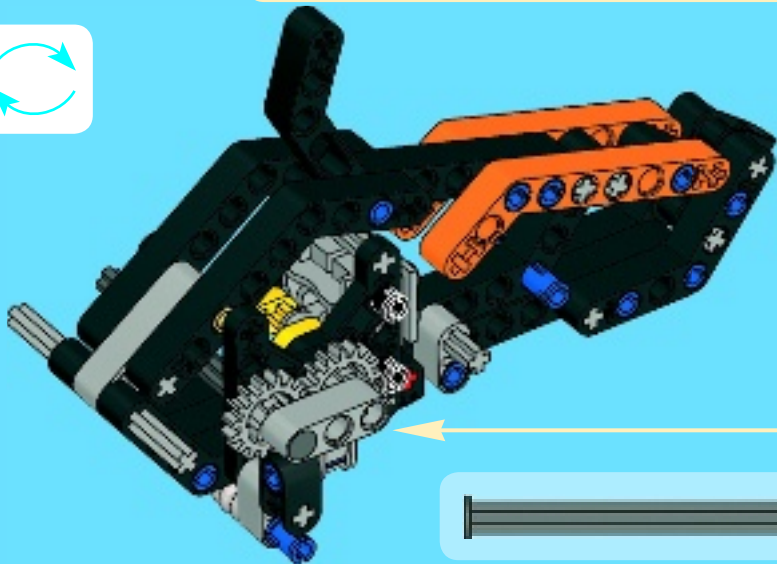
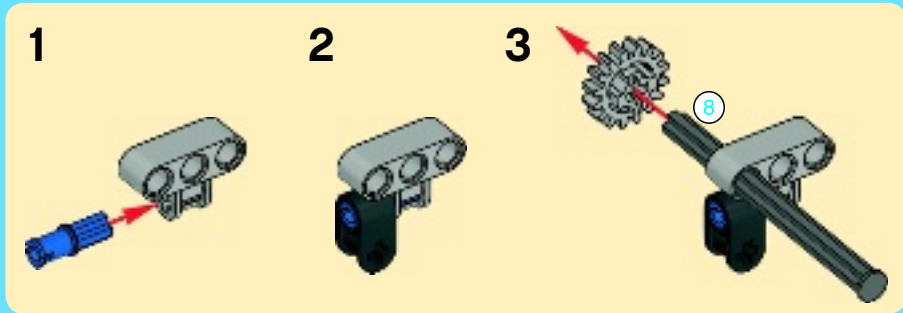



1

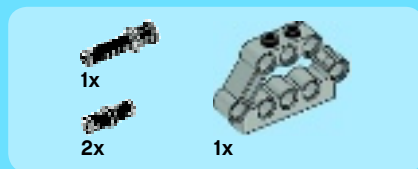

2

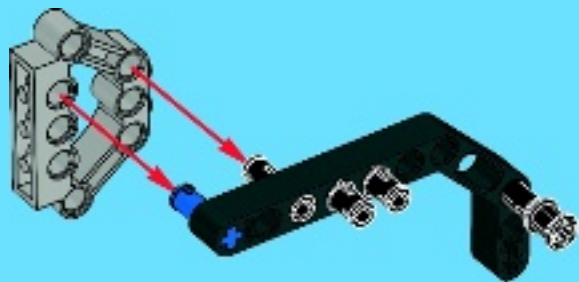

19

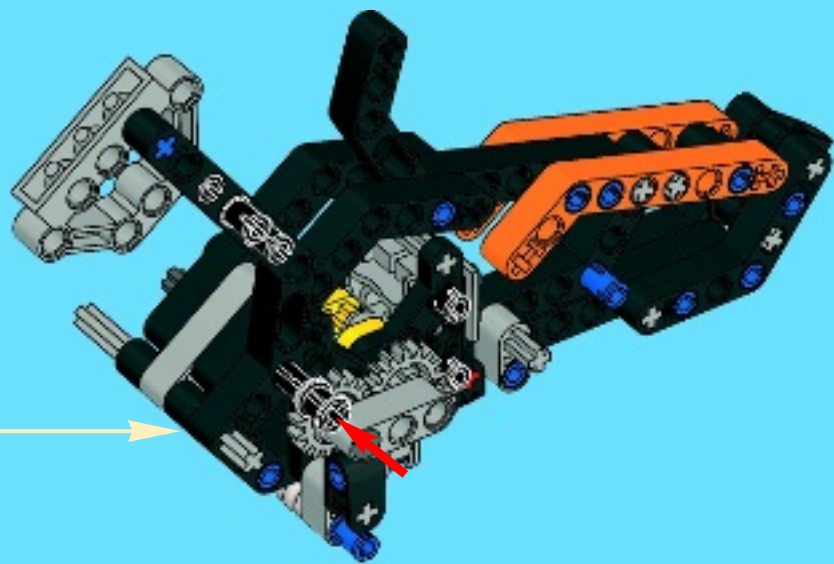





20

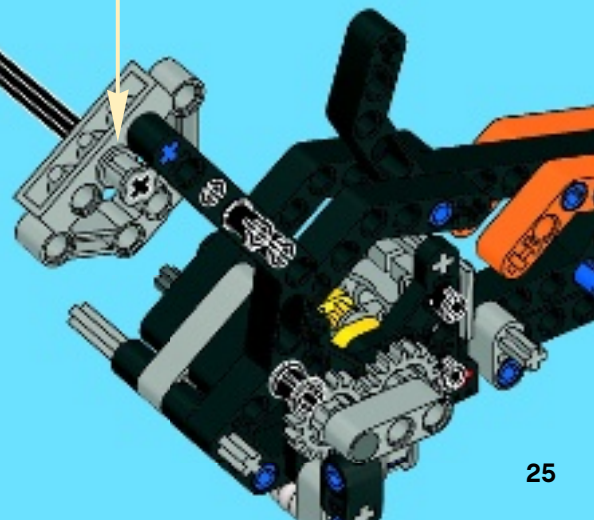



2x



1x

# 21

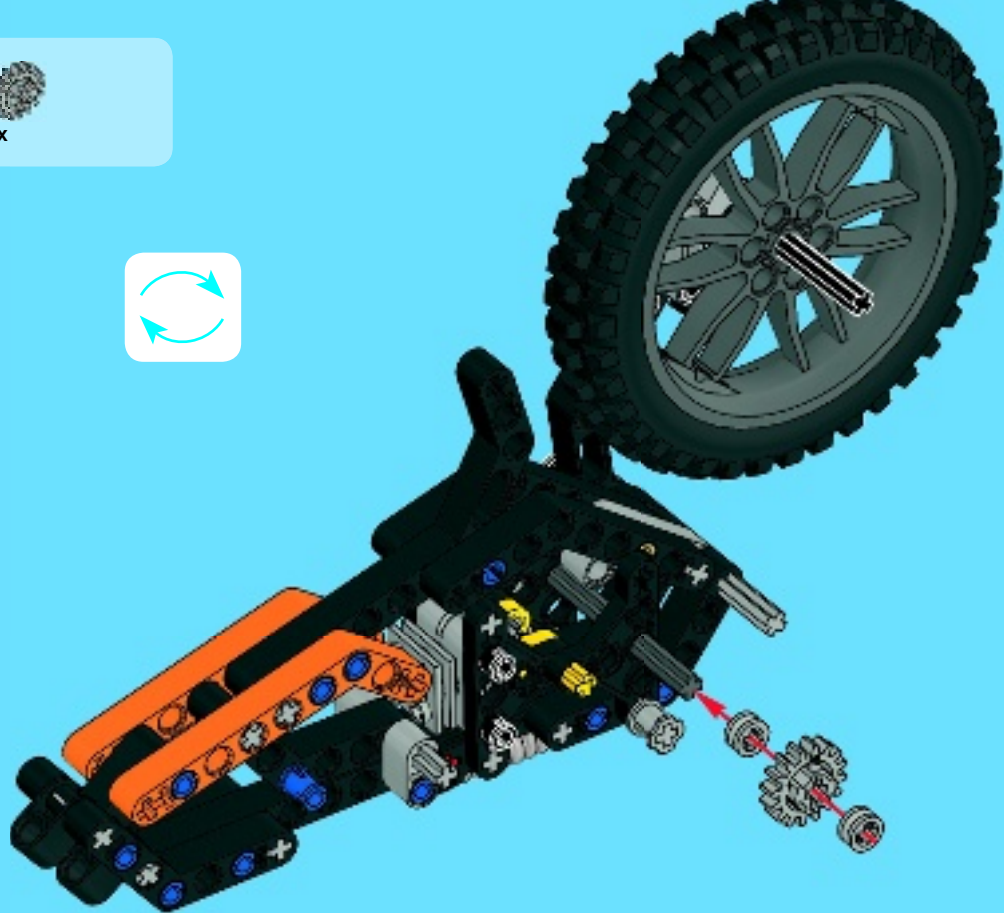

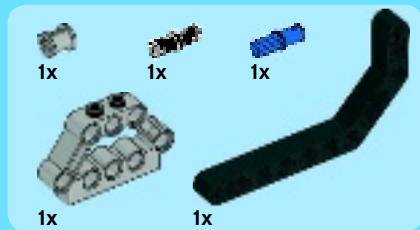

22

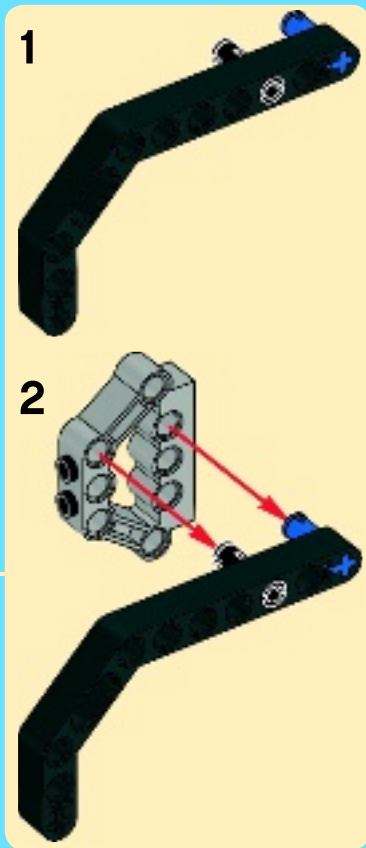



1x



1x

# 23



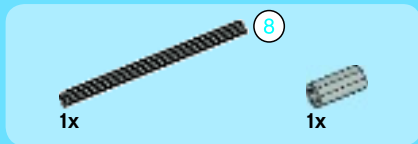

1

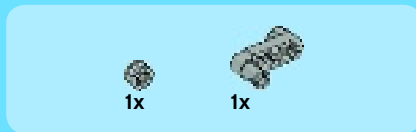
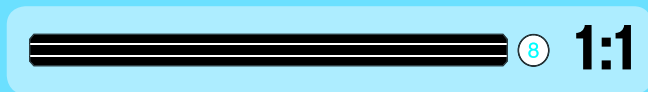
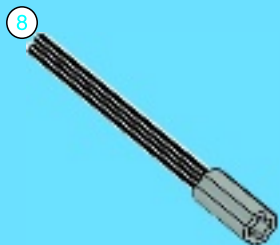

2

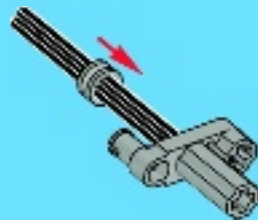

3

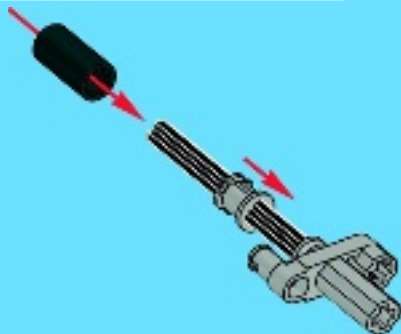



1x



1x

4

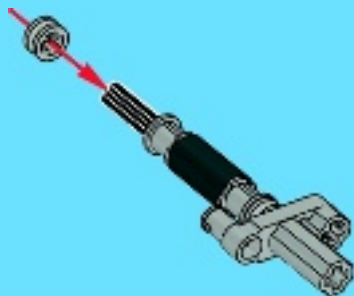

24





1x



1x

# 25



1x



1x



1x



# 26

1



2

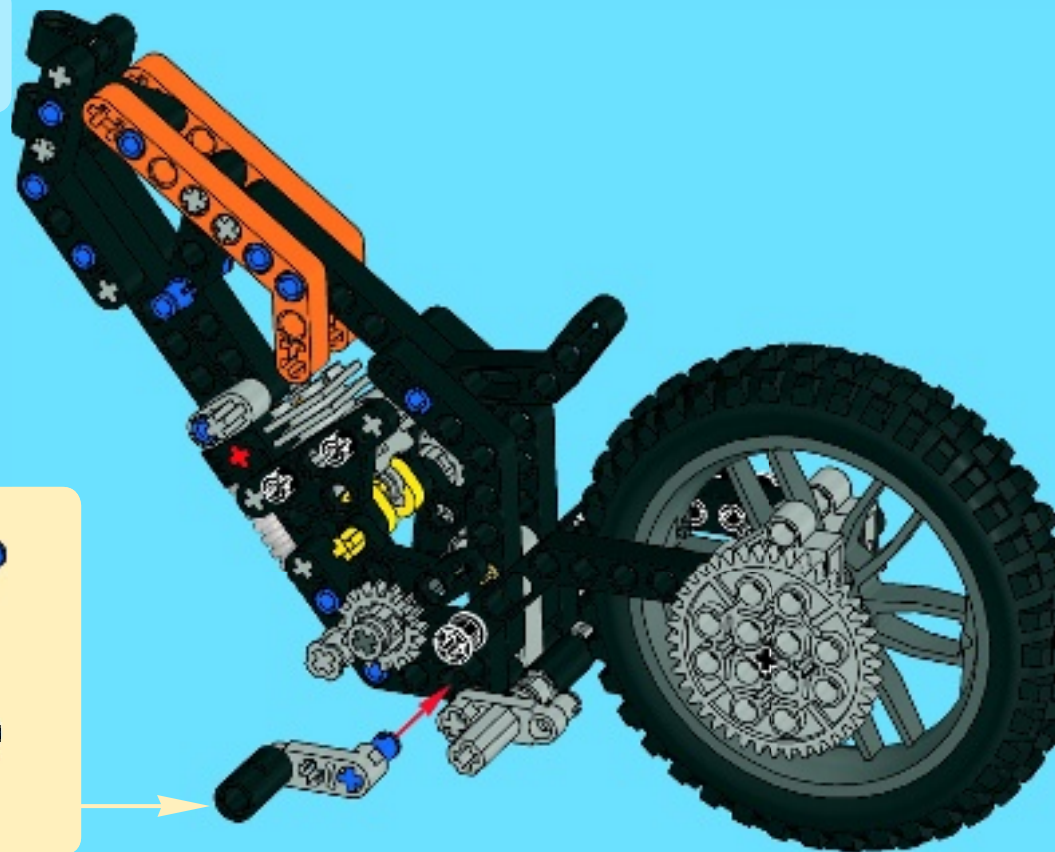



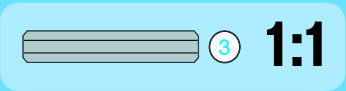
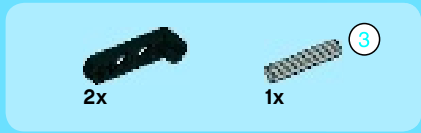

27





1

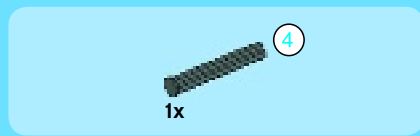
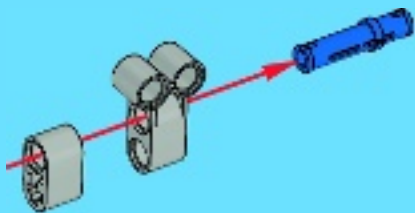

2

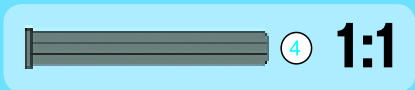
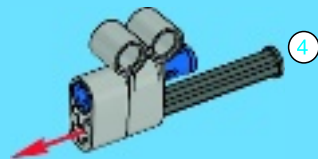



3

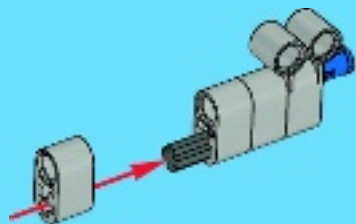

4

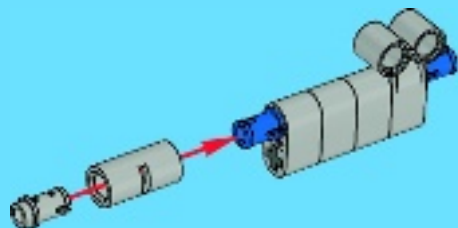

5

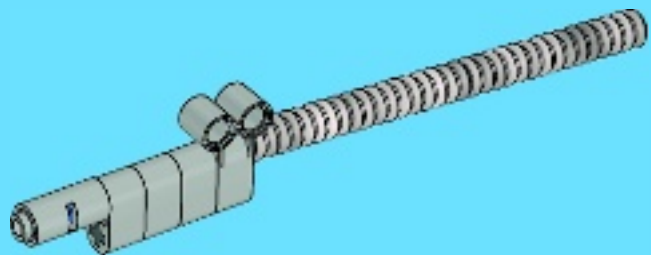

28



39x

29

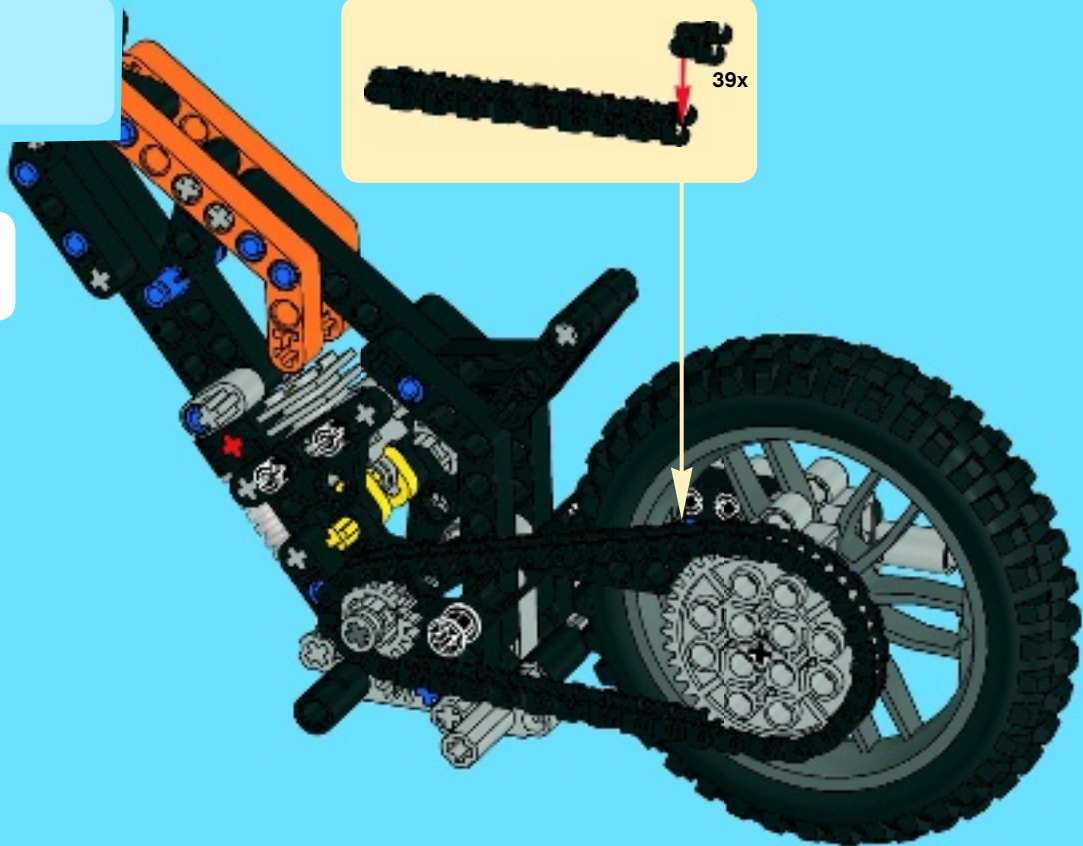



1

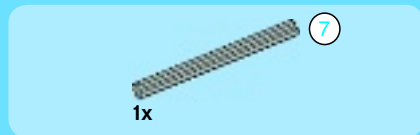

2

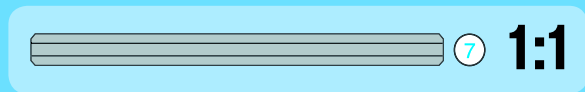
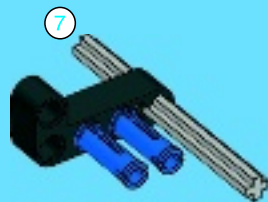



2x

3

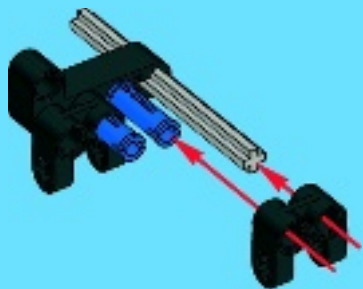

1x

4



2x

5



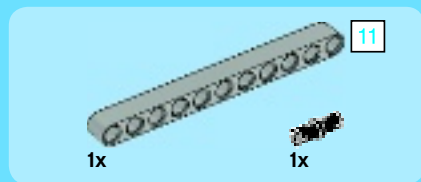

6

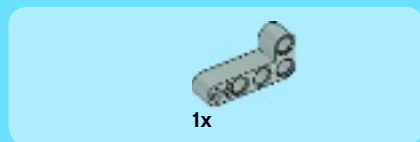
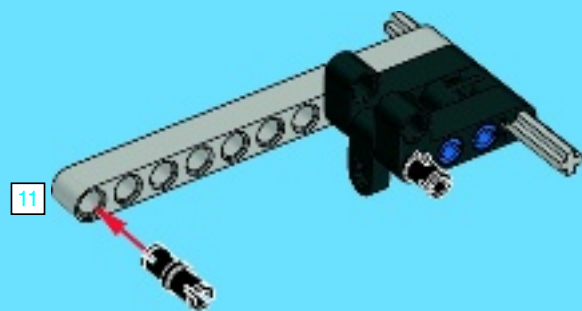

7

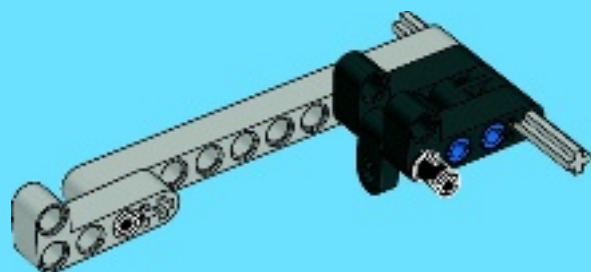



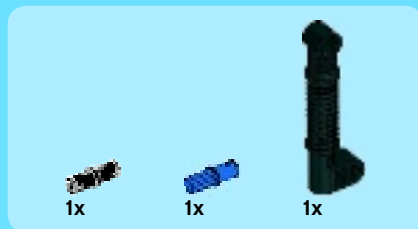

8

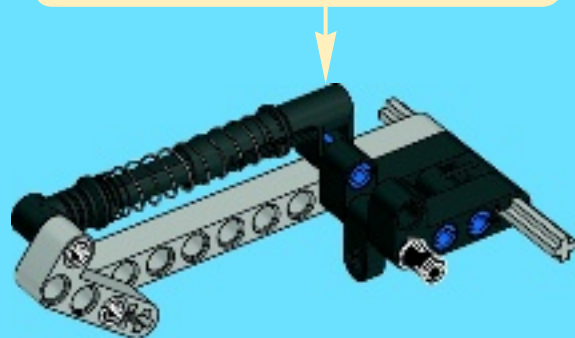
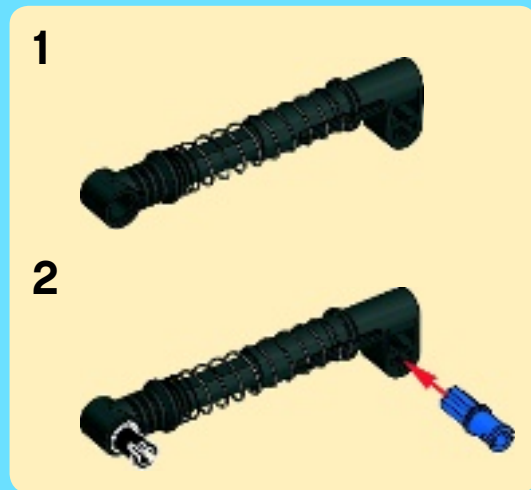

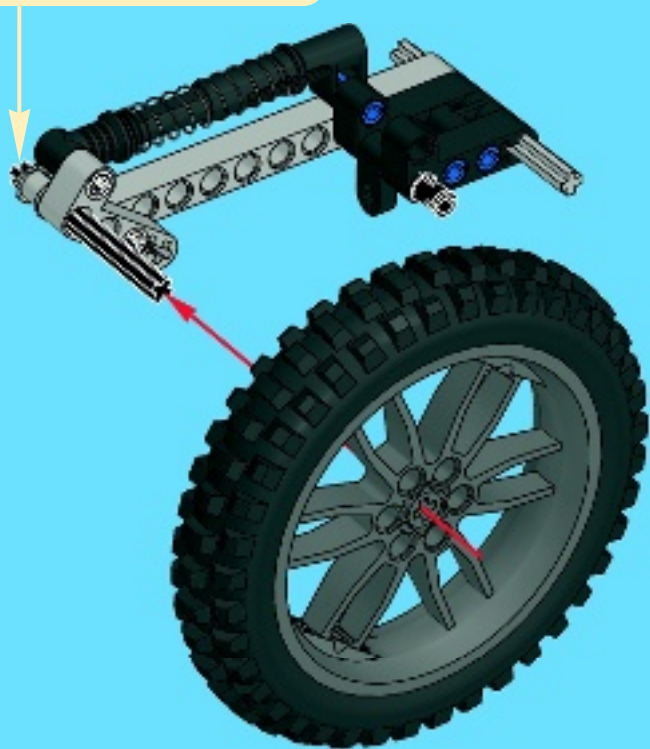

9



1

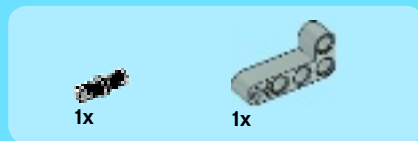

2

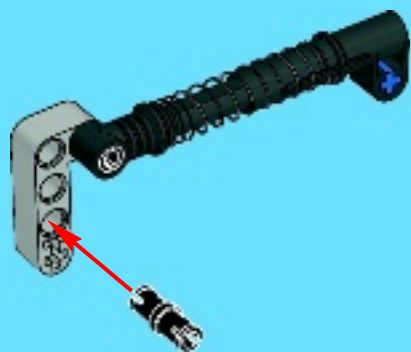



1x

10



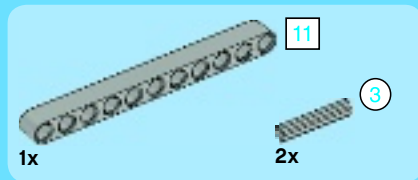

# 11



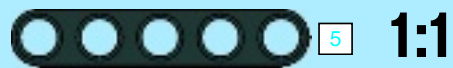

12



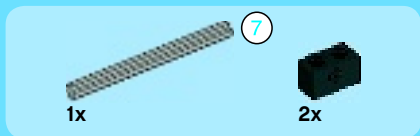

1

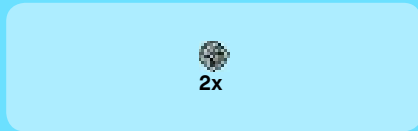
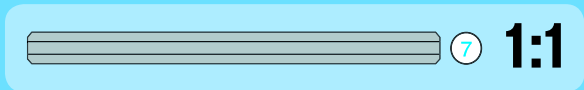
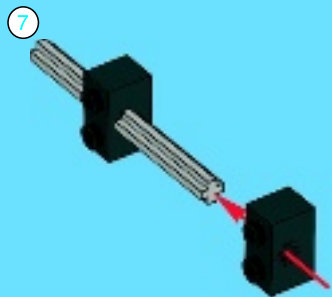

2

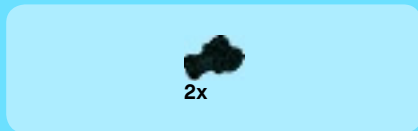
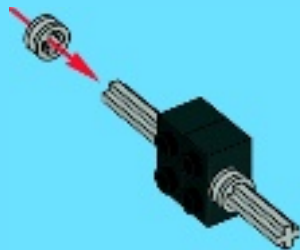

3



13



2x

14





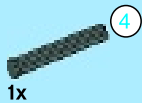

4

1:1

29

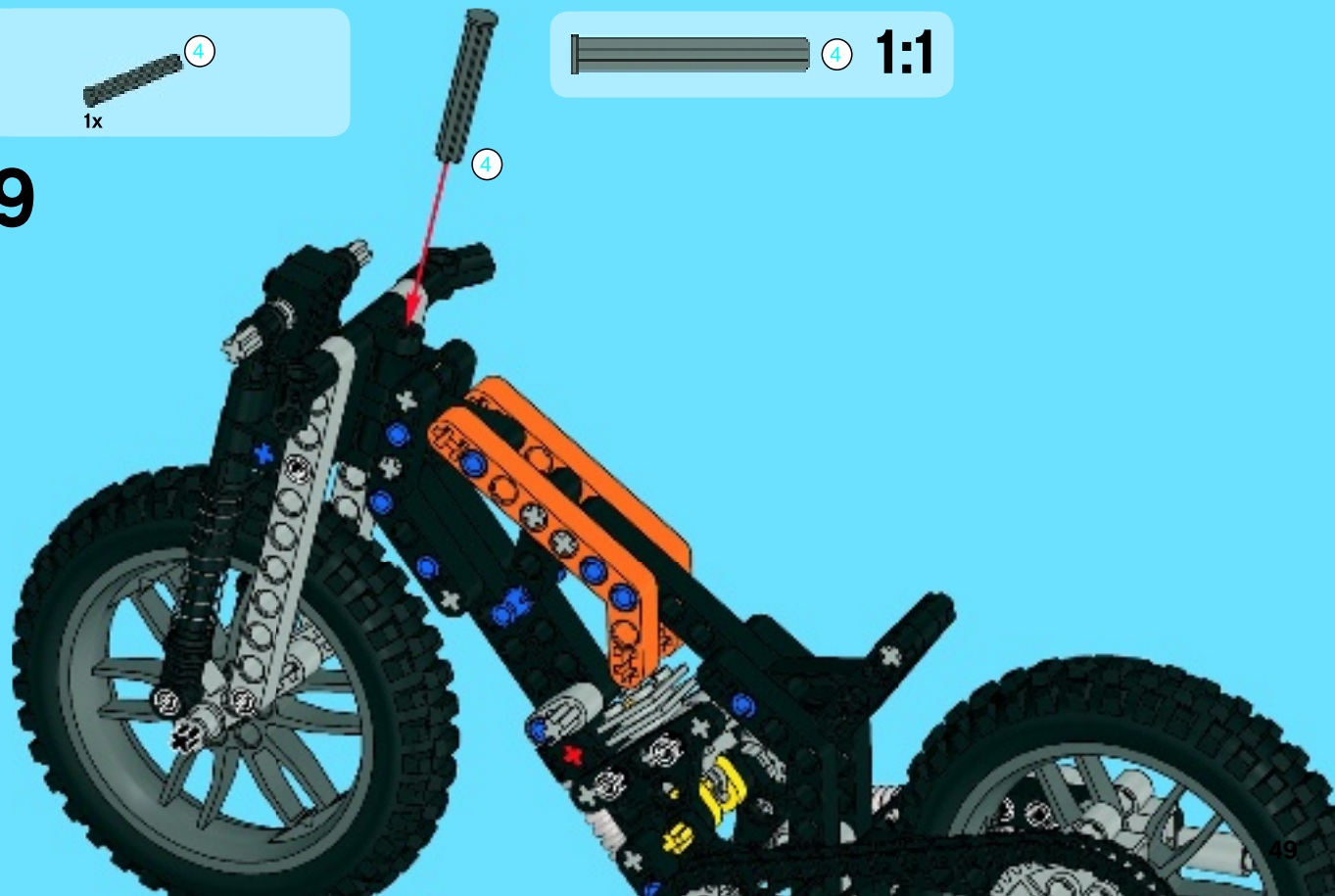

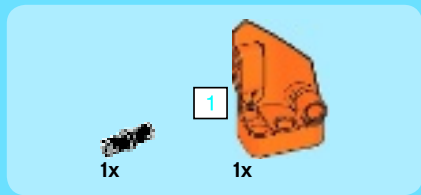

1

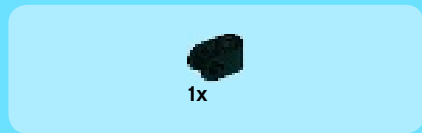
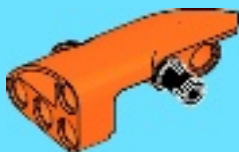

2

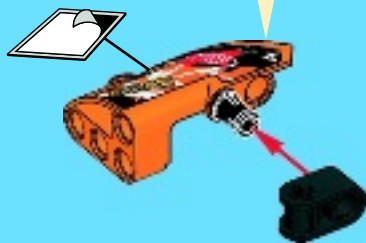

31



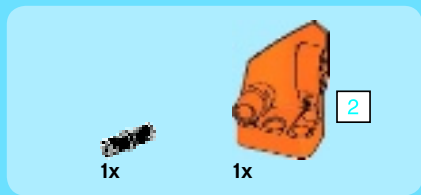

1

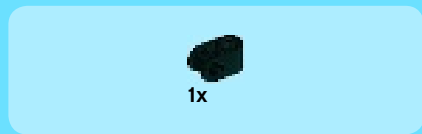

2

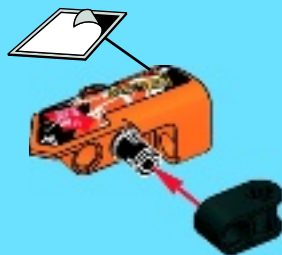

32

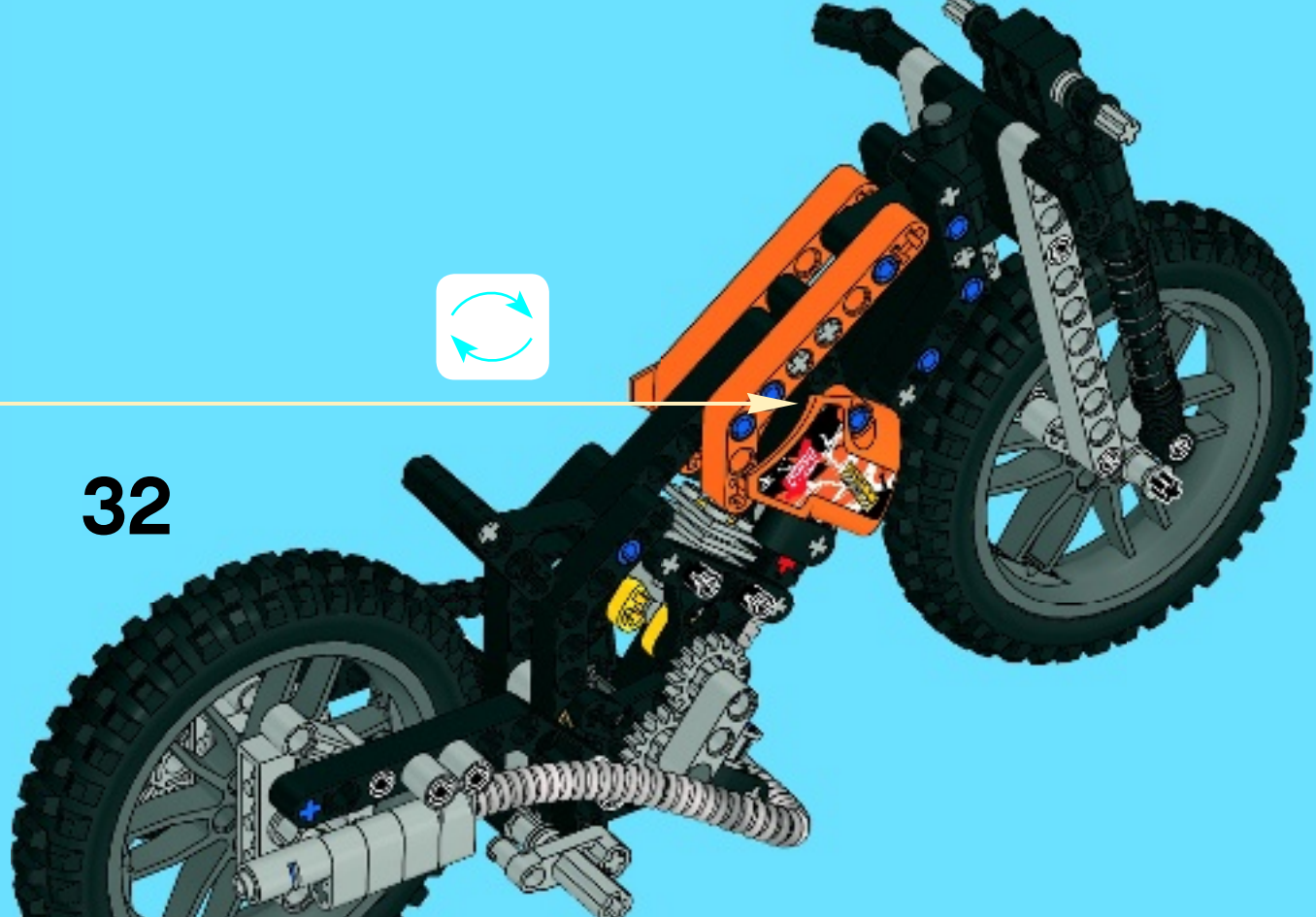



2x



2x

3

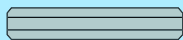

3

1:1

# 33

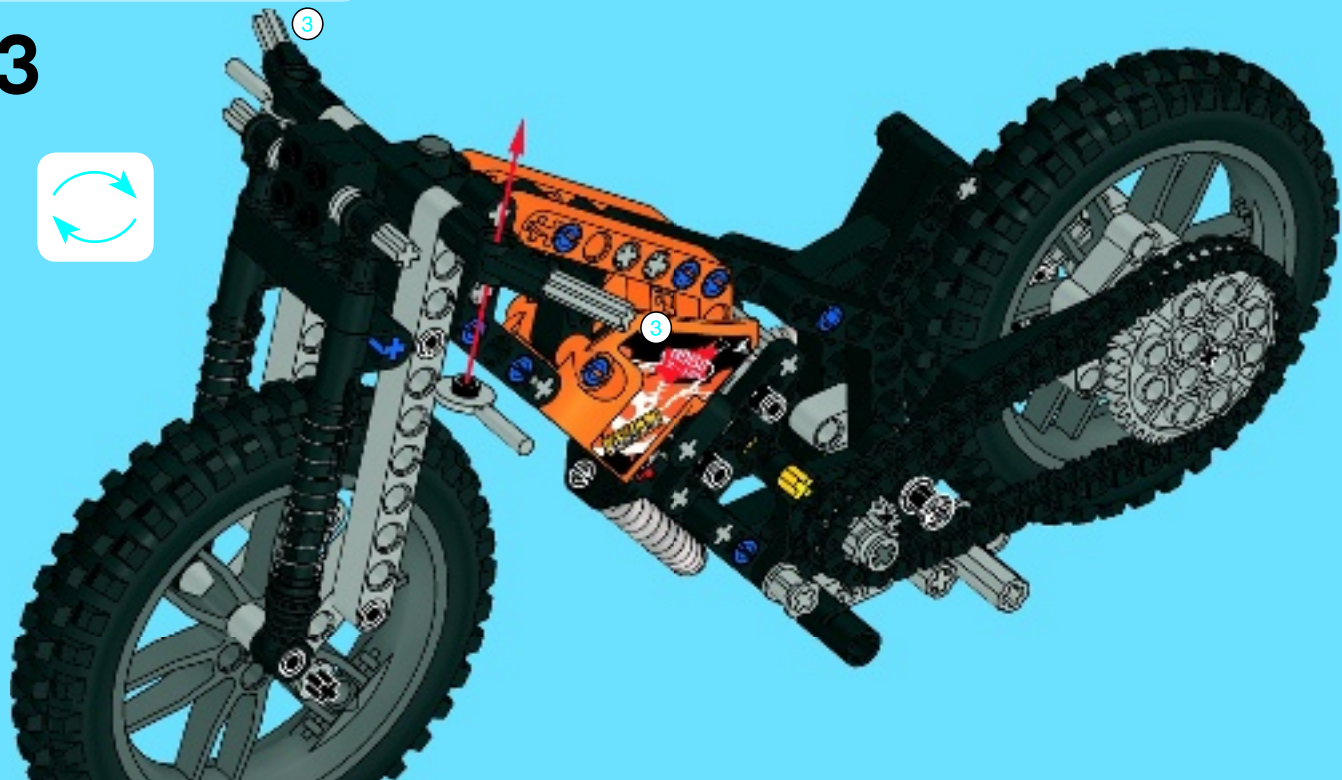



22

1x



21

1x

# 34

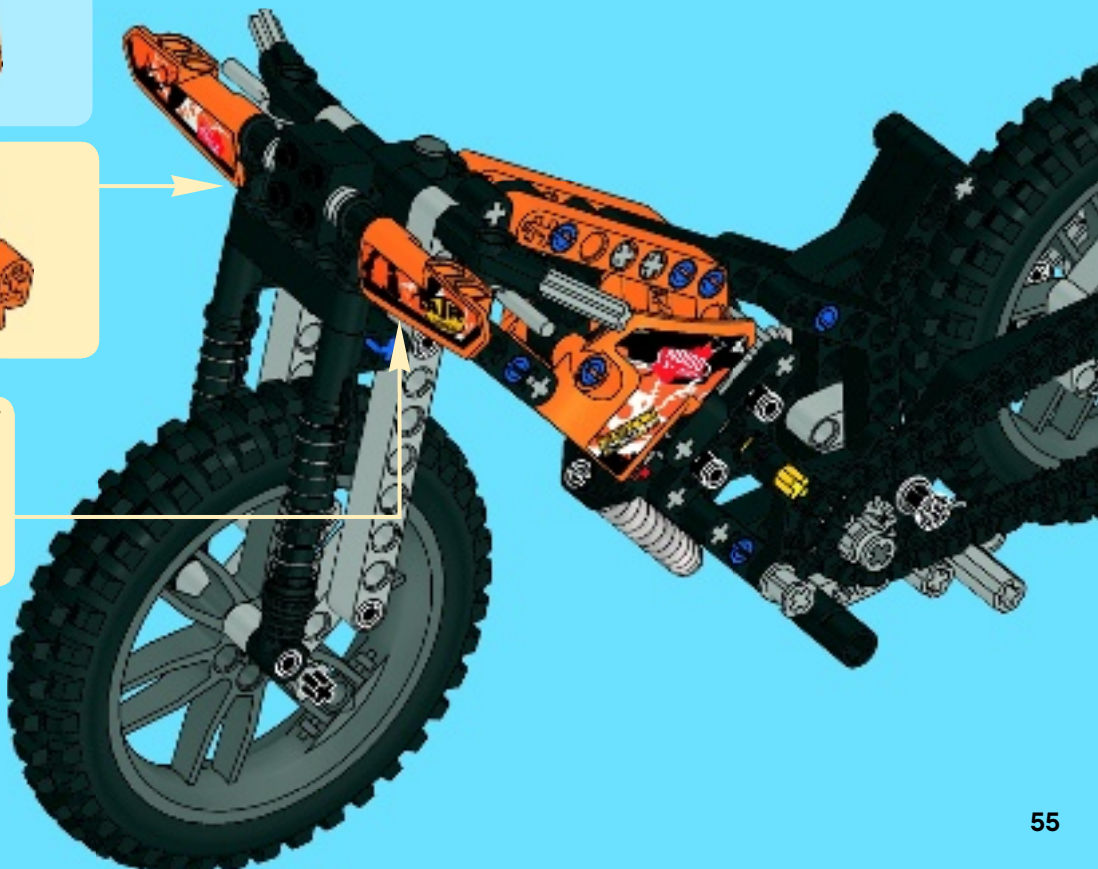



1x



1x

1

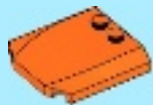

1x

2



2x

3



4





35



1x  
4514554

1x  
4565452

5x  
4142865

7x  
4206482

18x  
4514553

2x  
4112203

2x  
4119474

1x  
6027566

3x  
4233487

1x  
4219107

2x  
362326

1x  
302026

1x  
4185620

2x  
4142822

2x  
6028683

2x  
4120017

1x  
4542573

2x  
6021952

3x  
4111998

2x  
4112282

5x  
4128593

1x  
4142135

39x  
371126

1x  
4515340

6x  
4173668

4x  
6010864

2x  
4162857

1x  
4610371

2x  
4107082

2x  
4107136

17x  
4121715

2x  
4107081

2x  
4526982

6x  
4140801

2x  
370626

1x  
370726

1x  
4177430

2x  
4657639

1x  
6022768

1x  
6022767

1x  
4655340

8

22

21

2

6



1

1x  
4655339



1x  
6004919



14

1x  
6028760



13

1x  
6028757



2x  
4205761



2x  
4611705



2x  
4211397



2x  
4211753



3x  
4211610



2x  
4560175



1x  
4211714



7x  
6004888



1x  
4211629



1x  
4538007



2x  
4234251



9x  
4211573



1x  
4211483



4x  
4563045



2x  
6000018



9x  
4211622



2x  
4512360



1x  
4526985



3

16x  
4211815



5

2x  
4211639



7

6x  
4211805



3x  
4640536



1x  
4285634



1x  
4210688



3x  
4560177



1x  
4499858



2x  
4568006



1x  
4620076



1x  
4617492



Customer Service

Kundenservice

Service Consommateurs

Servicio Al Consumidor

LEGO.com/service or dial



: 00800 5346 5555

: 1-800-422-5346



# TECHNIC













LEGO.com

6042852 / 6042854

LEGO and the LEGO logo are trademarks of the/sont des  
marques de commerce de/sont des marques registradas de LEGO  
Group. ©2013 The LEGO Group.



[LEGO.com/technic](http://LEGO.com/technic)

Image	Qty	Item No	Description	MID
<b>Regular Items:</b>				
<b>Parts:</b>				
	1	<a href="#">42007stk01</a>	<b>Sticker for Set 42007 - (13074/6023227)</b> <a href="#">Catalog:</a> <a href="#">Parts:</a> <a href="#">Sticker</a>	
*				
	1	<a href="#">44567</a>	<b>Black Hinge Plate 1 x 2 Locking with 1 Finger on Side</b> <a href="#">Catalog:</a> <a href="#">Parts:</a> <a href="#">Hinge</a>	
* !				
	1	<a href="#">60471</a>	<b>Black Hinge Plate 1 x 2 Locking with 2 Fingers on Side</b> <a href="#">Catalog:</a> <a href="#">Parts:</a> <a href="#">Hinge</a>	
* !				
	2	<a href="#">3623</a>	<b>Black Plate 1 x 3</b> <a href="#">Catalog:</a> <a href="#">Parts:</a> <a href="#">Plate</a>	
* !				
	1	<a href="#">3020</a>	<b>Black Plate 2 x 4</b> <a href="#">Catalog:</a> <a href="#">Parts:</a> <a href="#">Plate</a>	
* !				
	2	<a href="#">3706</a>	<b>Black Technic, Axle 6</b> <a href="#">Catalog:</a> <a href="#">Parts:</a> <a href="#">Technic, Axle</a>	
* !				
	1	<a href="#">3707</a>	<b>Black Technic, Axle 8</b> <a href="#">Catalog:</a> <a href="#">Parts:</a> <a href="#">Technic, Axle</a>	
* !				
	2	<a href="#">32016</a>	<b>Black Technic, Axle and Pin Connector Angled #3 - 157.5 degrees</b> <a href="#">Catalog:</a> <a href="#">Parts:</a> <a href="#">Technic, Connector</a>	
* !				
	6	<a href="#">6536</a>	<b>Black Technic, Axle and Pin Connector Perpendicular</b> <a href="#">Catalog:</a> <a href="#">Parts:</a> <a href="#">Technic, Connector</a>	
* !				
	2	<a href="#">41678</a>	<b>Black Technic, Axle and Pin Connector Perpendicular Double Split</b> <a href="#">Catalog:</a> <a href="#">Parts:</a> <a href="#">Technic, Connector</a>	
* !				
	1	<a href="#">92907</a>	<b>Black Technic, Axle and Pin Connector Perpendicular Split</b> <a href="#">Catalog:</a> <a href="#">Parts:</a> <a href="#">Technic, Connector</a>	
* !				



2 [32039](#)

**Black Technic, Axle Connector with Axle Hole**

Catalog: [Parts](#): [Technic, Connector](#)

\* !



3 [32064](#)

**Black Technic, Brick 1 x 2 with Axle Hole**

Catalog: [Parts](#): [Technic, Brick](#)

\* !



1 [32269](#)

**Black Technic, Gear 20 Tooth Double Bevel**

Catalog: [Parts](#): [Technic, Gear](#)

\* !



2 [32523](#)

**Black Technic, Liftarm 1 x 3 Thick**

Catalog: [Parts](#): [Technic, Liftarm](#)

\* !



2 [2825](#)

**Black Technic, Liftarm 1 x 4 Thin with Stud Connector**

Catalog: [Parts](#): [Technic, Liftarm](#)

\* !



1 [32316](#)

**Black Technic, Liftarm 1 x 5 Thick**

Catalog: [Parts](#): [Technic, Liftarm](#)

\* !



5 [32348](#)

**Black Technic, Liftarm 1 x 7 Bent (4 - 4) Thick**

Catalog: [Parts](#): [Technic, Liftarm](#)

\* !



2 [6629](#)

**Black Technic, Liftarm 1 x 9 Bent (6 - 4) Thick**

Catalog: [Parts](#): [Technic, Liftarm](#)

\* !



1 [32278](#)

**Black Technic, Liftarm 1 x 15 Thick**

Catalog: [Parts](#): [Technic, Liftarm](#)

\* !



3 [32009](#)

**Black Technic, Liftarm 1 x 11.5 Double Bent Thick**

Catalog: [Parts](#): [Technic, Liftarm](#)

\* !



2 [32140](#)

**Black Technic, Liftarm 2 x 4 L-Shape Thick**

Catalog: [Parts](#): [Technic, Liftarm](#)

\* !



4 [99773](#)

**Black Technic, Liftarm Triangle Thin, Type II**

Catalog: [Parts](#): [Technic, Liftarm](#)

\* !



39 [3711](#)

**Black Technic, Link Chain**  
Catalog: [Parts: Technic, Link](#)

\* !



6 [32054](#)

**Black Technic, Pin 3L with Friction Ridges Lengthwise and Stop Bush**  
Catalog: [Parts: Technic, Pin](#)

\* !



2 [62462](#)

**Black Technic, Pin Connector Round 2L with Slot (Pin Joiner Round)**  
Catalog: [Parts: Technic, Connector](#)

\* !



17 [2780](#)

**Black Technic, Pin with Friction Ridges Lengthwise WITH Center Slots**  
Catalog: [Parts: Technic, Pin](#)

\* !



2 [2909c03](#) (Inv)

**Black Technic, Shock Absorber 9.5L, Complete Assembly (Soft Spring)**  
Catalog: [Parts: Technic, Shock Absorber](#)

\*



2 [11957](#)

**Black Tire 100.6mm D. Motorcycle**  
Catalog: [Parts: Tire & Tread](#)

\* !



1 [47753](#)

**Black Wedge 4 x 4 No Top Studs**  
Catalog: [Parts: Wedge](#)

\* !



7 [43093](#)

**Blue Technic, Axle Pin with Friction Ridges Lengthwise**  
Catalog: [Parts: Technic, Axle](#)

\* !



18 [6558](#)

**Blue Technic, Pin 3L with Friction Ridges Lengthwise**  
Catalog: [Parts: Technic, Pin](#)

\* !



3 [87083](#)

**Dark Bluish Gray Technic, Axle 4 with Stop**  
Catalog: [Parts: Technic, Axle](#)

\* !



1 [55013](#)

**Dark Bluish Gray Technic, Axle 8 with Stop**  
Catalog: [Parts: Technic, Axle](#)

\* !



1 [32192](#)

**Dark Bluish Gray Technic, Axle and Pin Connector Angled #4 - 135 degrees**  
Catalog: [Parts: Technic, Connector](#)

\* !



2 [88517](#)

**Dark Bluish Gray Wheel 75mm D. x 17mm Motorcycle**

Catalog: [Parts](#): [Wheel](#)

\* !



1 [78c06](#)

**Flat Silver Hose, Ribbed 7mm D. 6L**

Catalog: [Parts](#): [Hose, Ribbed 7mm D.](#)

\*



1 [78c11](#)

**Flat Silver Hose, Ribbed 7mm D. 11L**

Catalog: [Parts](#): [Hose, Ribbed 7mm D.](#)

\*



2 [3900](#)

**Light Bluish Gray Minifig, Utensil Signal Paddle**

Catalog: [Parts](#): [Minifig, Utensil](#)

\* !



2 [3022](#)

**Light Bluish Gray Plate 2 x 2**

Catalog: [Parts](#): [Plate](#)

\* !



9 [3713](#)

**Light Bluish Gray Technic Bush**

Catalog: [Parts](#): [Technic](#)

\* !



9 [4265c](#)

**Light Bluish Gray Technic Bush 1/2 Smooth**

Catalog: [Parts](#): [Technic](#)

\* !



2 [2852](#)

**Light Bluish Gray Technic Engine Connecting Rod**

Catalog: [Parts](#): [Technic](#)

\* !



2 [2850b](#)

**Light Bluish Gray Technic Engine Cylinder without Side Slots**

Catalog: [Parts](#): [Technic](#)

\*



16 [4519](#)

**Light Bluish Gray Technic, Axle 3**

Catalog: [Parts](#): [Technic, Axle](#)

\* !



2 [32073](#)

**Light Bluish Gray Technic, Axle 5**

Catalog: [Parts](#): [Technic, Axle](#)

\* !



6 [44294](#)

**Light Bluish Gray Technic, Axle 7**

Catalog: [Parts](#): [Technic, Axle](#)

\* !





1 [32291](#)

**Light Bluish Gray Technic, Axle and Pin Connector Perpendicular Double**  
Catalog: [Parts](#): [Technic](#), [Connector](#)

\* !



1 [63869](#)

**Light Bluish Gray Technic, Axle and Pin Connector Perpendicular Triple**  
Catalog: [Parts](#): [Technic](#), [Connector](#)

\* !



2 [6538c](#)

**Light Bluish Gray Technic, Axle Connector 2L (Smooth with x Hole + Orientation)**  
Catalog: [Parts](#): [Technic](#), [Connector](#)

\* !



3 [94925](#)

**Light Bluish Gray Technic, Gear 16 Tooth (New Style Reinforced)**  
Catalog: [Parts](#): [Technic](#), [Gear](#)

\* !



1 [3649](#)

**Light Bluish Gray Technic, Gear 40 Tooth**  
Catalog: [Parts](#): [Technic](#), [Gear](#)

\* !



7 [60483](#)

**Light Bluish Gray Technic, Liftarm 1 x 2 Thick with Pin Hole and Axle Hole**  
Catalog: [Parts](#): [Technic](#), [Liftarm](#)

\* !



4 [33299](#)

**Light Bluish Gray Technic, Liftarm 1 x 3 with 2 Axle Holes and Pin / Crank**  
Catalog: [Parts](#): [Technic](#), [Liftarm](#)

\* !



2 [32525](#)

**Light Bluish Gray Technic, Liftarm 1 x 11 Thick**  
Catalog: [Parts](#): [Technic](#), [Liftarm](#)

\* !



3 [32140](#)

**Light Bluish Gray Technic, Liftarm 2 x 4 L-Shape Thick**  
Catalog: [Parts](#): [Technic](#), [Liftarm](#)

\*



1 [4274](#)

**Light Bluish Gray Technic, Pin 1/2**  
Catalog: [Parts](#): [Technic](#), [Pin](#)

\* !



2 [87082](#)

**Light Bluish Gray Technic, Pin 3L with Friction Ridges Lengthwise and Center Pin Hole**  
Catalog: [Parts](#): [Technic](#), [Pin](#)

\* !



2 [32333](#)

**Light Bluish Gray Technic, Pin Connector Block 1 x 5 x 3**  
Catalog: [Parts](#): [Technic](#), [Connector](#)

\* !



1 [32557](#)

**Light Bluish Gray Technic, Pin Connector Perpendicular Double 3L**  
Catalog: [Parts](#): [Technic](#), [Connector](#)



1 [62462](#)

**Light Bluish Gray Technic, Pin Connector Round 2L with Slot (Pin Joiner Round)**  
Catalog: [Parts](#): [Technic](#), [Connector](#)



2 [32271](#)

**Orange Technic, Liftarm 1 x 9 Bent (7 - 3) Thick**  
Catalog: [Parts](#): [Technic](#), [Liftarm](#)



1 [87080](#)

**Orange Technic, Panel Fairing # 1 Small Smooth Short, Side A**  
Catalog: [Parts](#): [Technic](#), [Panel](#)



1 [87086](#)

**Orange Technic, Panel Fairing # 2 Small Smooth Short, Side B**  
Catalog: [Parts](#): [Technic](#), [Panel](#)



1 [64394](#)

**Orange Technic, Panel Fairing #13 Large Short Smooth, Side A**  
Catalog: [Parts](#): [Technic](#), [Panel](#)



1 [64680](#)

**Orange Technic, Panel Fairing #14 Large Short Smooth, Side B**  
Catalog: [Parts](#): [Technic](#), [Panel](#)



1 [11946](#)

**Orange Technic, Panel Fairing #21 Very Small Smooth, Side B**  
Catalog: [Parts](#): [Technic](#), [Panel](#)

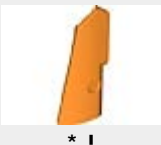

1 [11947](#)

**Orange Technic, Panel Fairing #22 Very Small Smooth, Side A**  
Catalog: [Parts](#): [Technic](#), [Panel](#)



1 [45677](#)

**Orange Wedge 4 x 4 x 2/3 Triple Curved**  
Catalog: [Parts](#): [Wedge](#)



5 [32062](#)

**Red Technic, Axle 2 Notched**  
Catalog: [Parts](#): [Technic](#), [Axle](#)



1 [6589](#)

**Tan Technic, Gear 12 Tooth Bevel**  
Catalog: [Parts](#): [Technic](#), [Gear](#)



1 [32556](#)

**Tan Technic, Pin 3L without Friction Ridges Lengthwise**

Catalog: [Parts](#): [Technic, Pin](#)

\* !

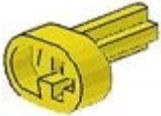

2 [2853](#)

**Yellow Technic Engine Crankshaft**

Catalog: [Parts](#): [Technic](#)

1

\* !



2 [2851](#)

**Yellow Technic Engine Piston Round**

Catalog: [Parts](#): [Technic](#)

2

\* !



1 [731c04](#) (Inv)

**Yellow Technic, Shock Absorber 6.5L, Complete Assembly - Hard Spring**

Catalog: [Parts](#): [Technic, Shock Absorber](#)

\*

### Extra Items:

#### Parts:



2 [3711](#)

**Black Technic, Link Chain**

Catalog: [Parts](#): [Technic, Link](#)

\*



1 [2780](#)

**Black Technic, Pin with Friction Ridges Lengthwise WITH Center Slots**

Catalog: [Parts](#): [Technic, Pin](#)

\*



1 [78c06](#)

**Flat Silver Hose, Ribbed 7mm D. 6L**

Catalog: [Parts](#): [Hose, Ribbed 7mm D.](#)

\*



1 [78c11](#)

**Flat Silver Hose, Ribbed 7mm D. 11L**

Catalog: [Parts](#): [Hose, Ribbed 7mm D.](#)

\*



2 [3713](#)

**Light Bluish Gray Technic Bush**

Catalog: [Parts](#): [Technic](#)

\*



1 [4265c](#)

**Light Bluish Gray Technic Bush 1/2 Smooth**

Catalog: [Parts](#): [Technic](#)

\*



1 [4274](#)

**Light Bluish Gray Technic, Pin 1/2**

Catalog: [Parts](#): [Technic, Pin](#)

\*

**Tan Technic, Gear 12 Tooth Bevel**



1 [6589](#)

Catalog: [Parts](#): [Technic](#), [Gear](#)

\*

**Counterparts:**

Parts:



2 [88517c02](#) ([Inv](#))

**Dark Bluish Gray Wheel 75mm D. x 17mm Motorcycle with Black Tire  
100.6mm D. Motorcycle (88517 / 11957)**

Catalog: [Parts](#): [Wheel & Tire Assembly](#)

\*

**Alternate Items:**

Parts:



2 [2853](#)

**Bright Light Orange Technic Engine Crankshaft**

Catalog: [Parts](#): [Technic](#)

1

\*



2 [2851](#)

**Bright Light Orange Technic Engine Piston Round**

Catalog: [Parts](#): [Technic](#)

2

\*

**Summary:**

Type	Unique Lots	Total Qty
<b>Regular Items:</b>		
Parts	75	253
<b>Extra Items:</b>		
Parts	8	10
<b>Counterparts:</b>		
Parts	1	2
<b>Alternate Items:</b>		
Parts	2	4

**Source:**

Parts List

[hellomrzebra \(237\)](#)  inventoried this Set on Jan 28, 2013, inventory last updated on May 10, 2015.