



10219





MAERSK

1650



1970

1980

19



1651



1552

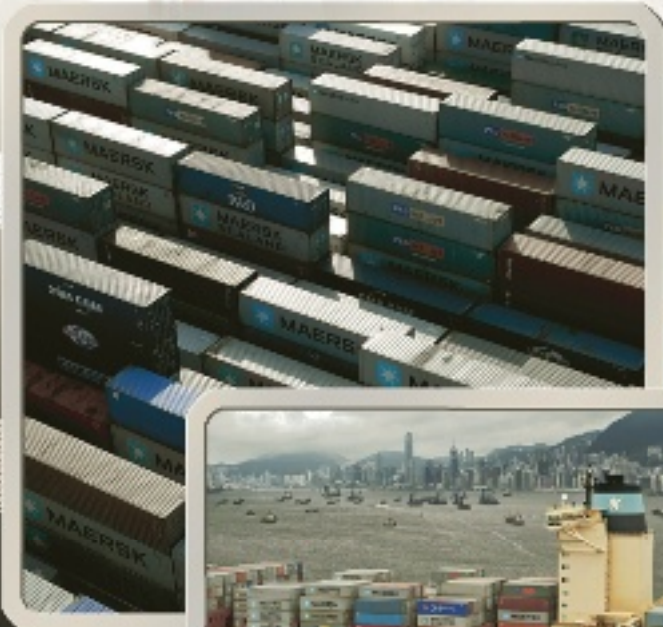

10152



10219



90

2000

2010



1831



10155



A.P. MOLLER – MAERSK GROUP - The LEGO Group History

The relationship between The LEGO Group and A.P. MOLLER – MAERSK GROUP was founded on a personal relationship between Godtfred Kirk Christiansen and Mærsk Mc-Kinney Møller. The first Maersk promotional set was a Maersk Line container ship released in 1974. Now, more than 37 years later, 10219 Maersk Train is inspired by an actual train that transported containers across the United States.

2 million Maersk containers are currently in circulation worldwide. The white containers, or 'reefers', are different from the gray containers because they are refrigerated. One of the longest container trains ever was pulled by nine locomotives and stretched almost 3.5 miles in length!



Geschichte A.P. MOLLER – MAERSK GROUP - der LEGO™ Gruppe

Die Kooperation zwischen der LEGO™ Gruppe und A.P. MOLLER – MAERSK GROUP gründet auf der Freundschaft zwischen Godtfred Kirk Christiansen und Mærsk Mc-Kinney Møller. Das erste Maersk Promotionset war ein Maersk Line Containerschiff, das 1974 auf den Markt kam. Heute, über 37 Jahre später, ist es der 10219 Maersk Zug von einem echten Zug inspiriert, der Container quer durch die Vereinigten Staaten transportierte.

2 Millionen Maersk Container sind derzeit weltweit auf Schienen unterwegs. Der Unterschied zwischen den weißen und den grauen Containern ist, dass die weißen gekühlt sind. Einer der längsten Containerzüge, den es jemals gab, wurde von neun Lokomotiven gezogen und war 5,6 km lang!



MAERSK

1650



1970

1980

19



1651



1552



A A.P. MOLLER – MAERSK GROUP - LEGO Csoport története

A LEGO Csoport és a A.P. MOLLER – MAERSK GROUP közötti kapcsolatot két ember, Godtfred Kirk Christiansen és Mærsk Mc-Kinney Møller személyes kapcsolatával kezdődött. Az első Maersk promóciós készlet egy Maersk Line konténerhajó volt, amely 1974-ben jelent meg. Most, több mint 37 évvel később, a 10219-es Maersk Train ötletét egy létező vonat adta, amely konténereket szállított az Egyesült Államokon keresztül.

Jelenleg 2 millió Maersk konténer van úton világszerte. A fehér konténerek vagy 'reefer'-ek mások, mint a szürkék, mert ezek hűtőkonténerek. A valaha volt egyik leghosszabb konténervonatot kilenc mozdony húzta, és több mint 5,6 kilométer hosszú volt!



História da A.P. MOLLER – MAERSK GROUP - LEGO Group

A relação entre a LEGO Group e a A.P. MOLLER – MAERSK GROUP foi fundada com base numa relação pessoal entre Godtfred Kirk Christiansen e Mærsk Mc-Kinney Møller. O primeiro conjunto promocional Maersk foi um navio porta-contentores lançado em 1974. Agora, 37 anos mais tarde, o Comboio Maersk, modelo 10219, inspira-se num comboio autêntico que transportava contentores nos Estados Unidos.

2 milhões de contentores Maersk circulam actualmente no mundo. Os contentores brancos são diferentes dos contentores cinzentos porque são refrigerados. Um dos mais compridos comboios porta-contentores de sempre foi puxado por nove locomotivas e prolongava-se ao longo de quase 5,6 Km!

10152



10219



90

2000

2010



1831



10155



Les origines de l'association entre A.P. MOLLER – MAERSK GROUP et le Groupe LEGO

L'association entre le Groupe LEGO et A.P. MOLLER – MAERSK GROUP est née de la relation personnelle entre Godtfred Kirk Christiansen et Mærsk Mc-Kinney Møller. Le premier ensemble promotionnel Maersk était un navire porte-conteneurs Maersk lancé en 1974. Aujourd'hui, 37 ans plus tard, le train Maersk, le modèle 10219, est inspiré d'un vrai train qui transportait des conteneurs aux États-Unis.

Deux millions de conteneurs Maersk sont actuellement en circulation dans le monde. Les conteneurs blancs sont différents des conteneurs gris car ils sont réfrigérés. L'un des trains transporteurs de conteneurs les plus longs était tiré par neuf locomotives et mesurait plus de 5,6 km de long !



Historia de la relación entre A.P. MOLLER – MAERSK GROUP y el Grupo LEGO

La relación entre el Grupo LEGO y A.P. MOLLER – MAERSK GROUP tiene su origen en la amistad que mantenían Godtfred Kirk Christiansen y Mærsk Mc-Kinney Møller. El primer set promocional dedicado a Maersk fue un barco de mercancías de Maersk Line comercializado en 1974. Hoy, más de 37 años después, presentamos el set número 10219, Tren de Maersk, inspirado en un tren auténtico que transportaba contenedores a lo largo de Estados Unidos.

En la actualidad circulan alrededor del mundo un total de 2 millones de contenedores de Maersk. Los contenedores de color blanco se diferencian de los de color gris en que son de tipo refrigerado. ¡Uno de los trenes dedicados al transporte de contenedores más largo que ha existido contaba con nueve locomotoras y tenía una longitud de 5,6 kilómetros!

1

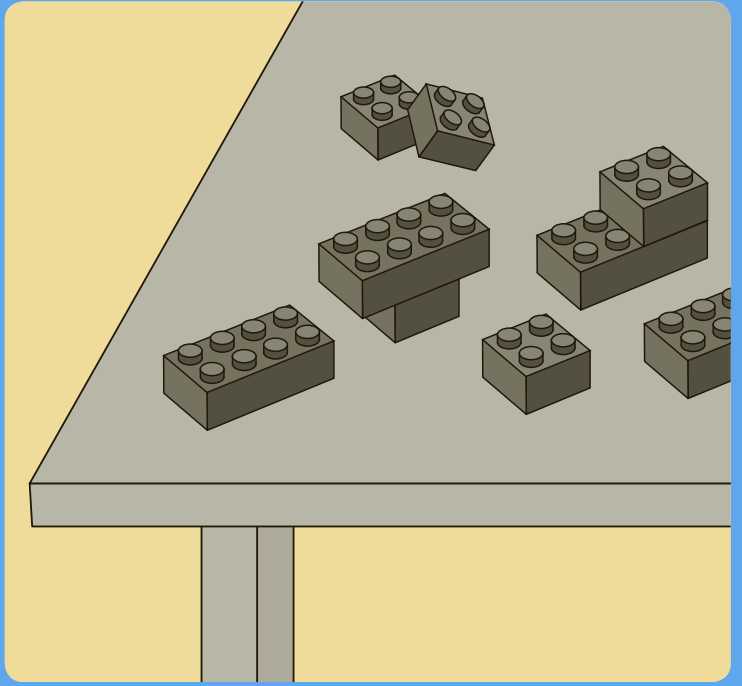
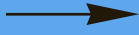
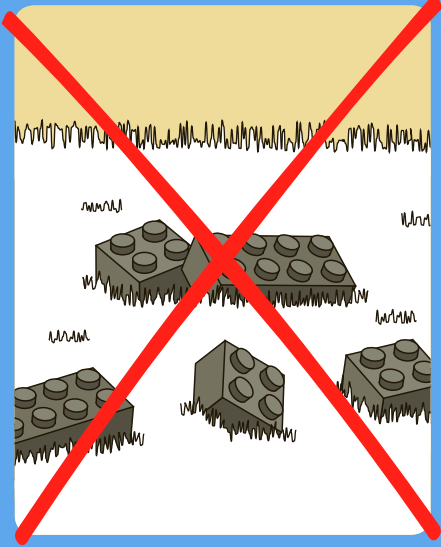

2





+

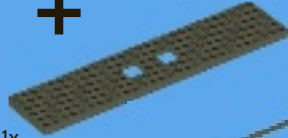

1x



4x



2x





2x

1



2x

2

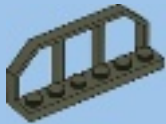

1x

3





4

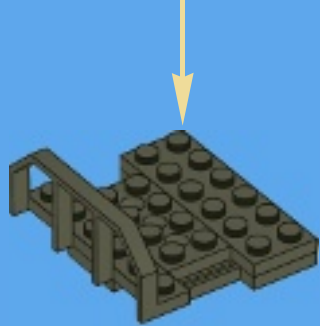
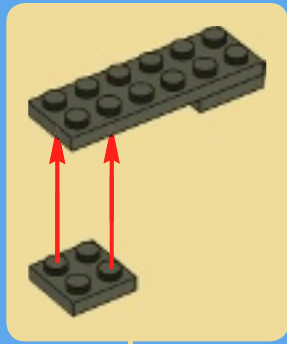

5





2x



2x

6

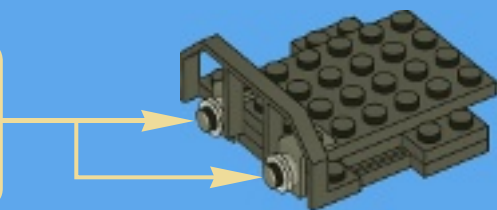
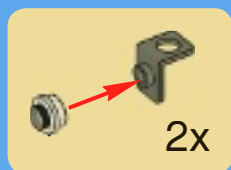

7

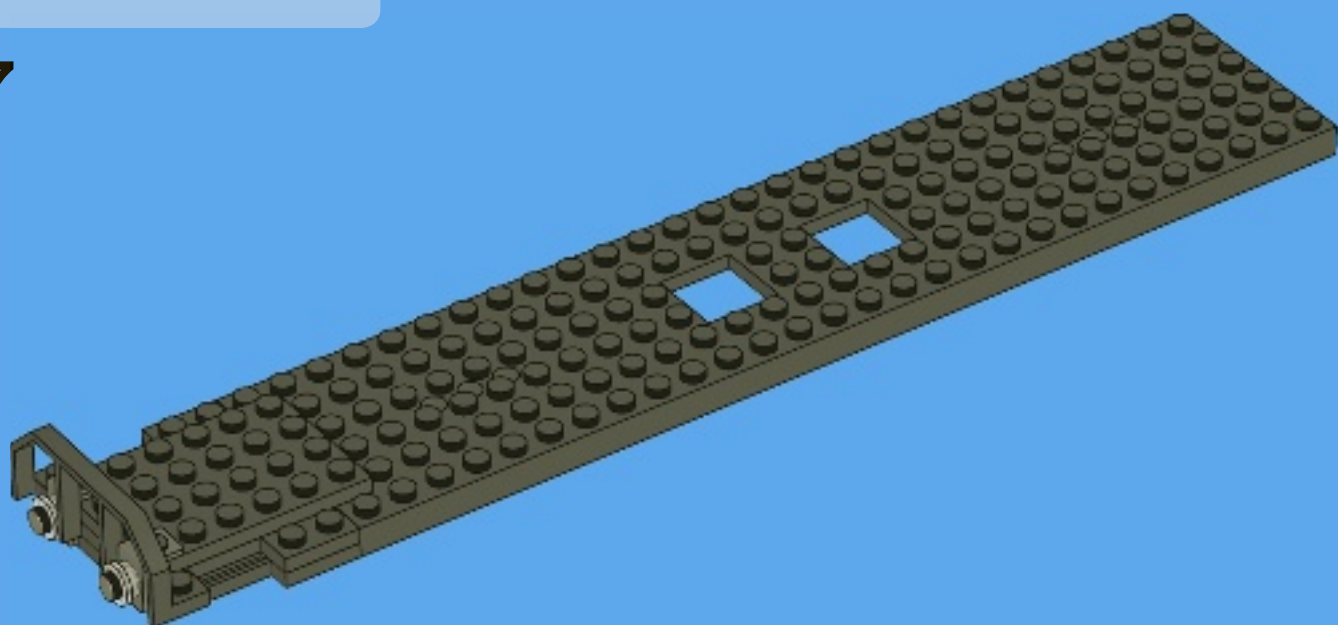



2x

1

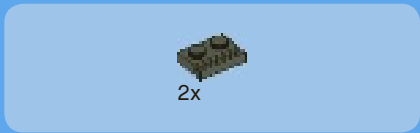

2x

2

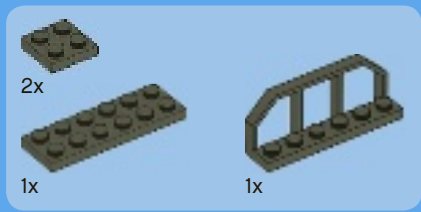

2x

1x

1x

3

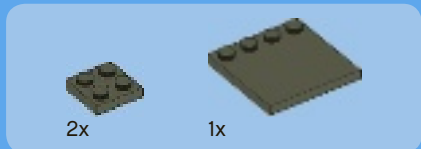
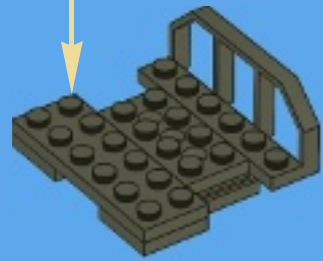
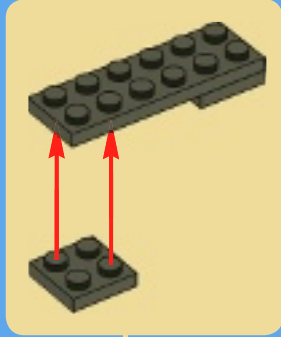

2x

1x

4

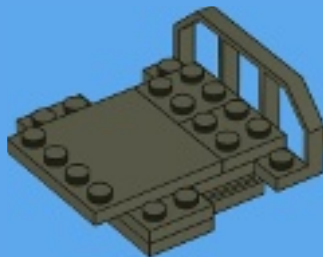



2x



2x

5

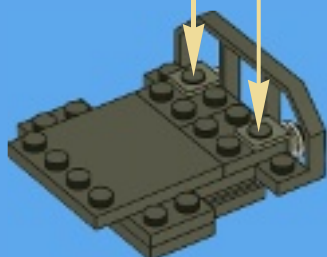

8

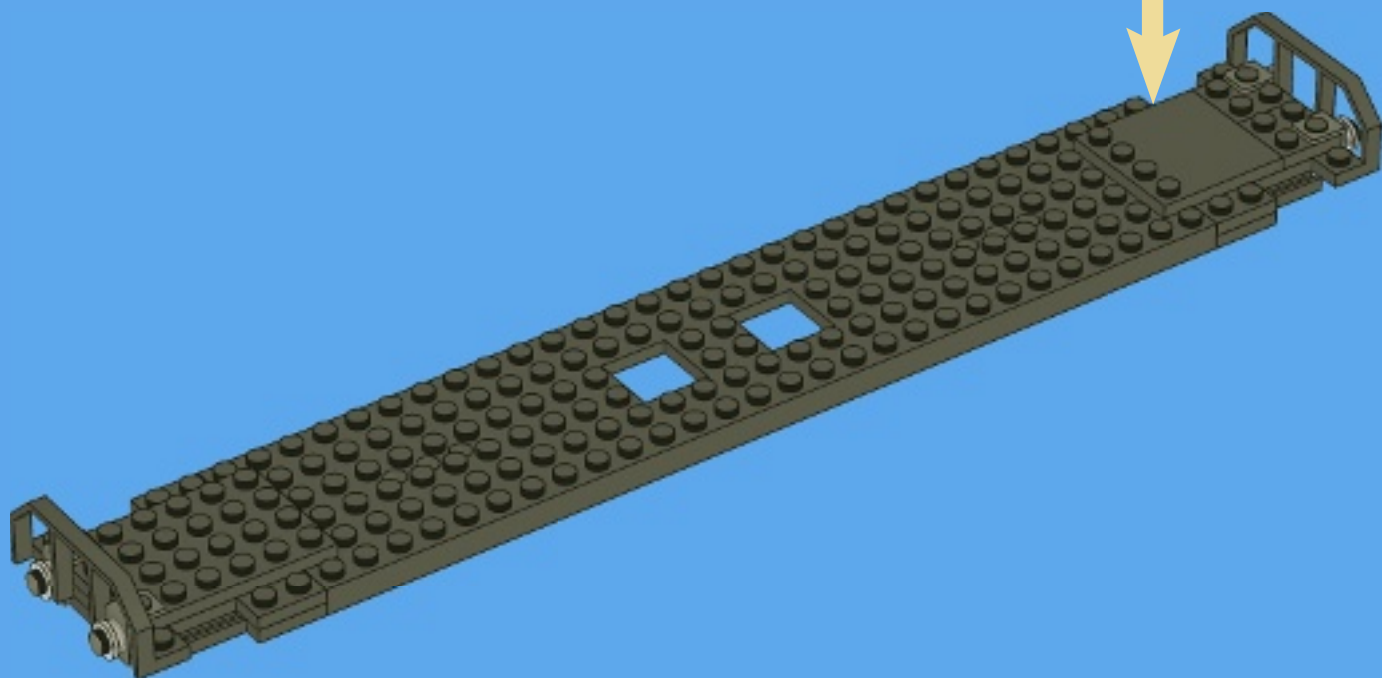

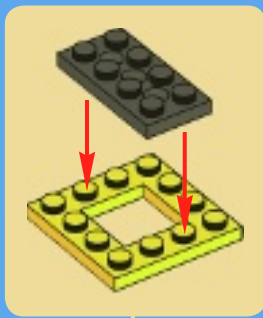
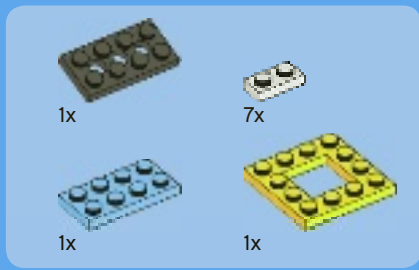

9

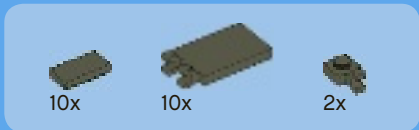
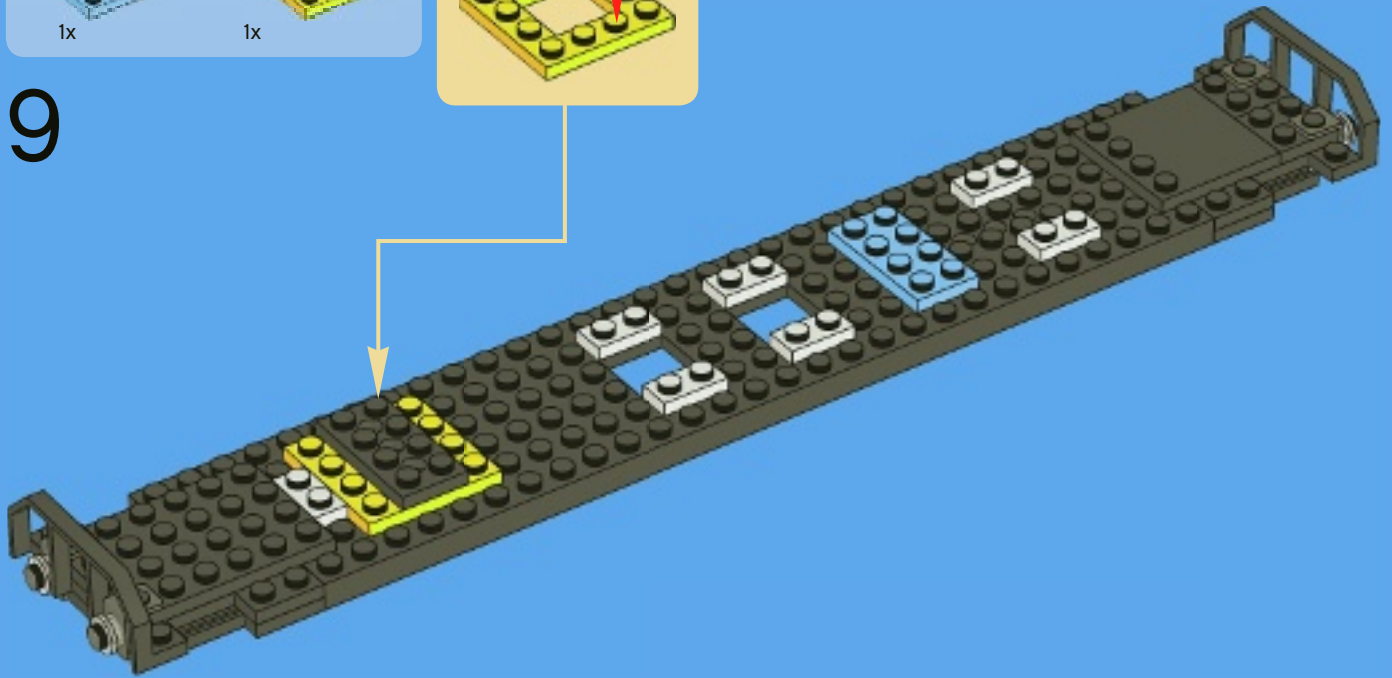

10

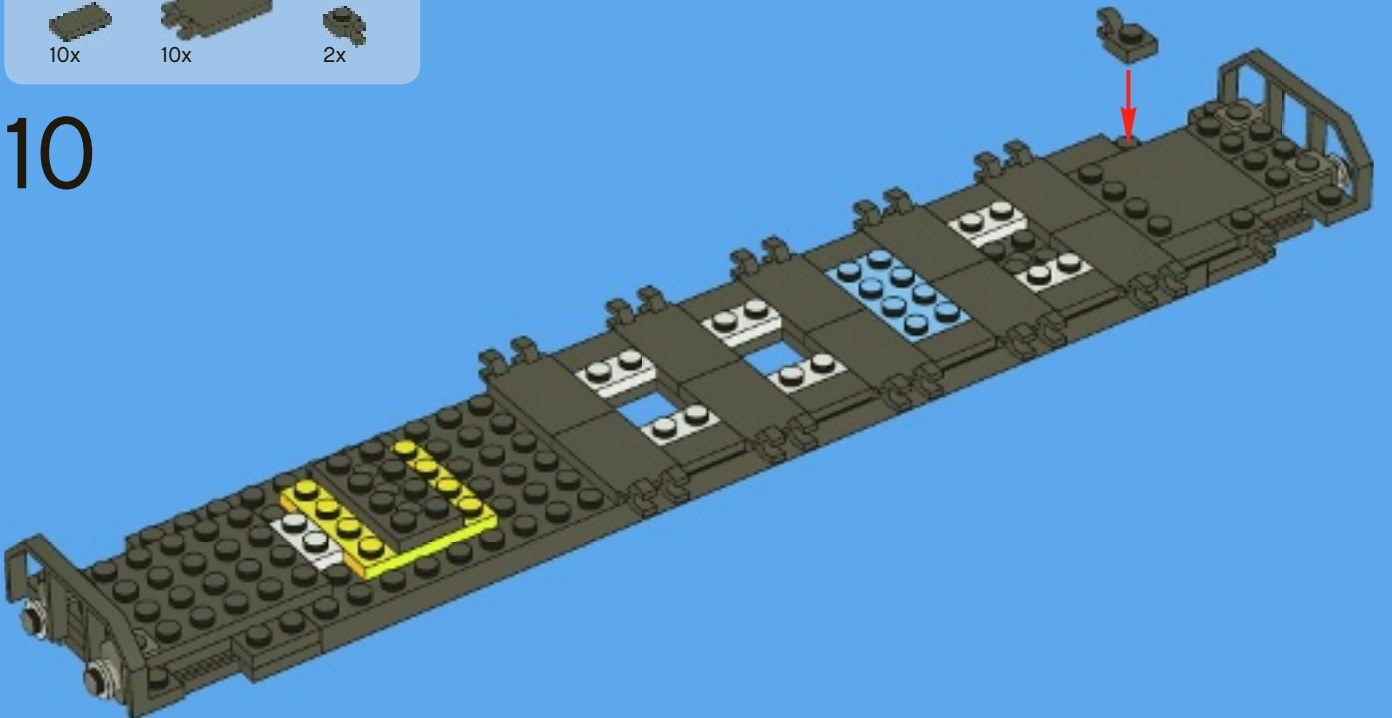

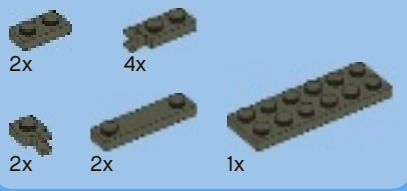

11

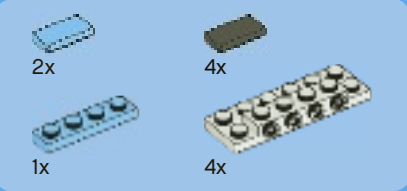
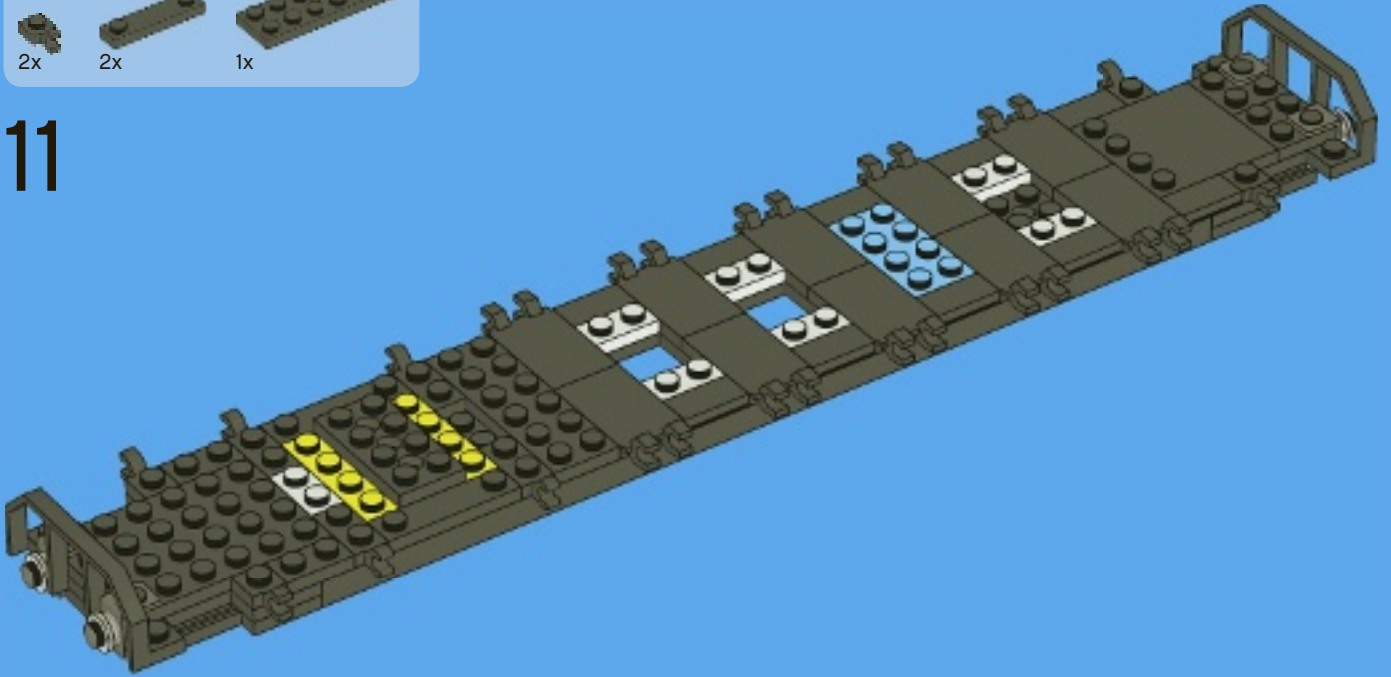

12

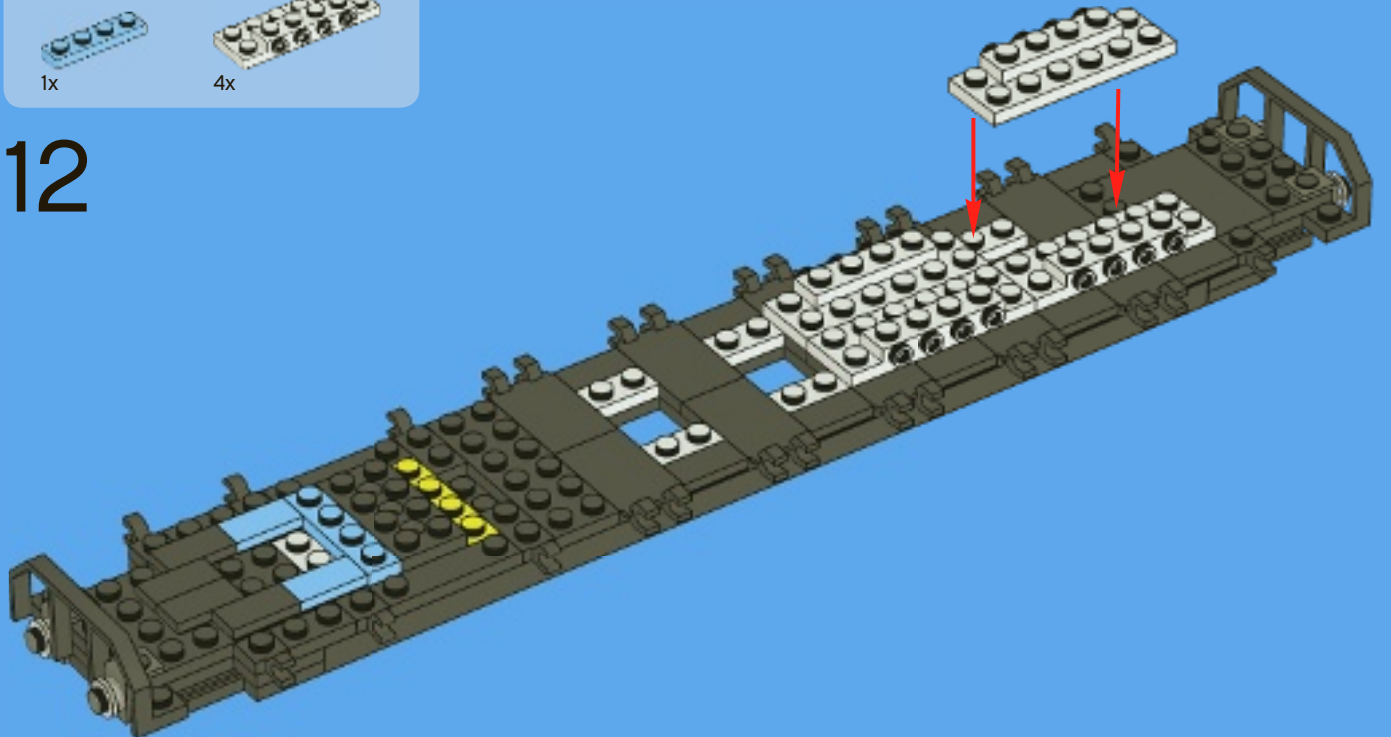



13

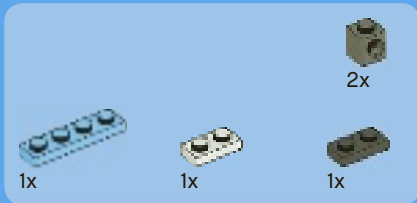
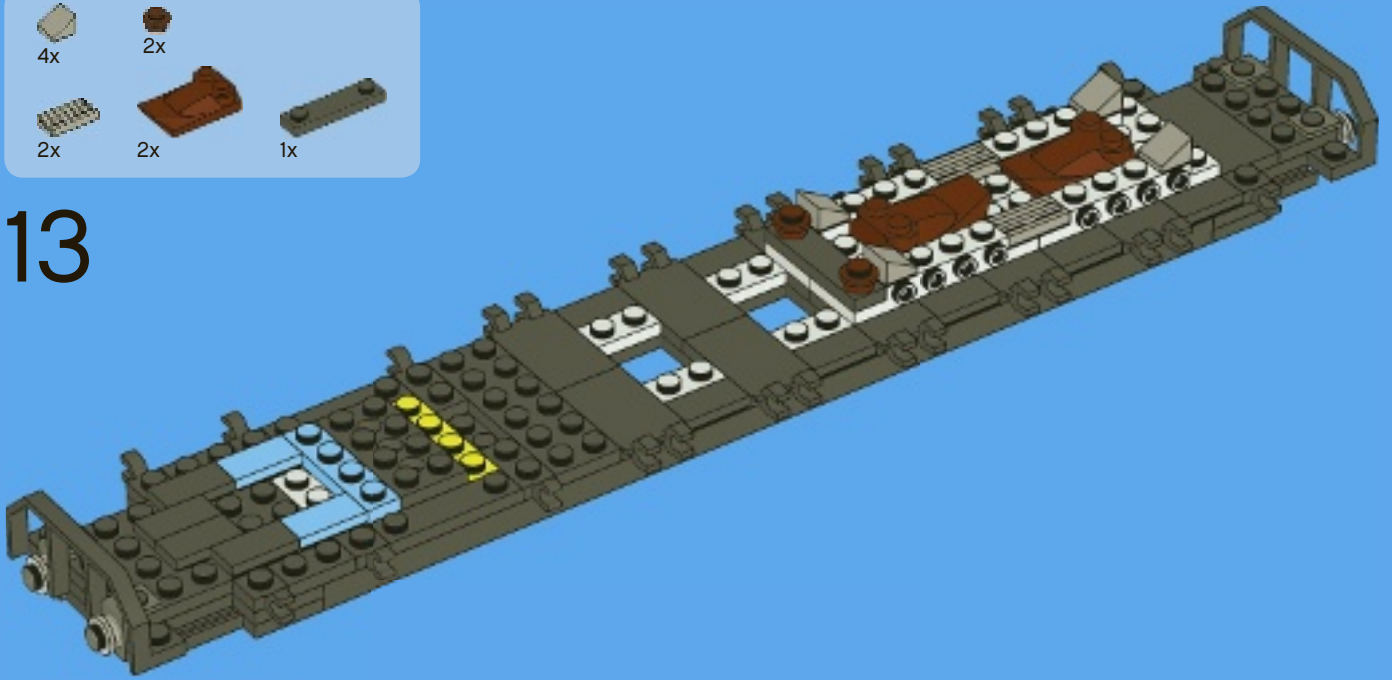

14

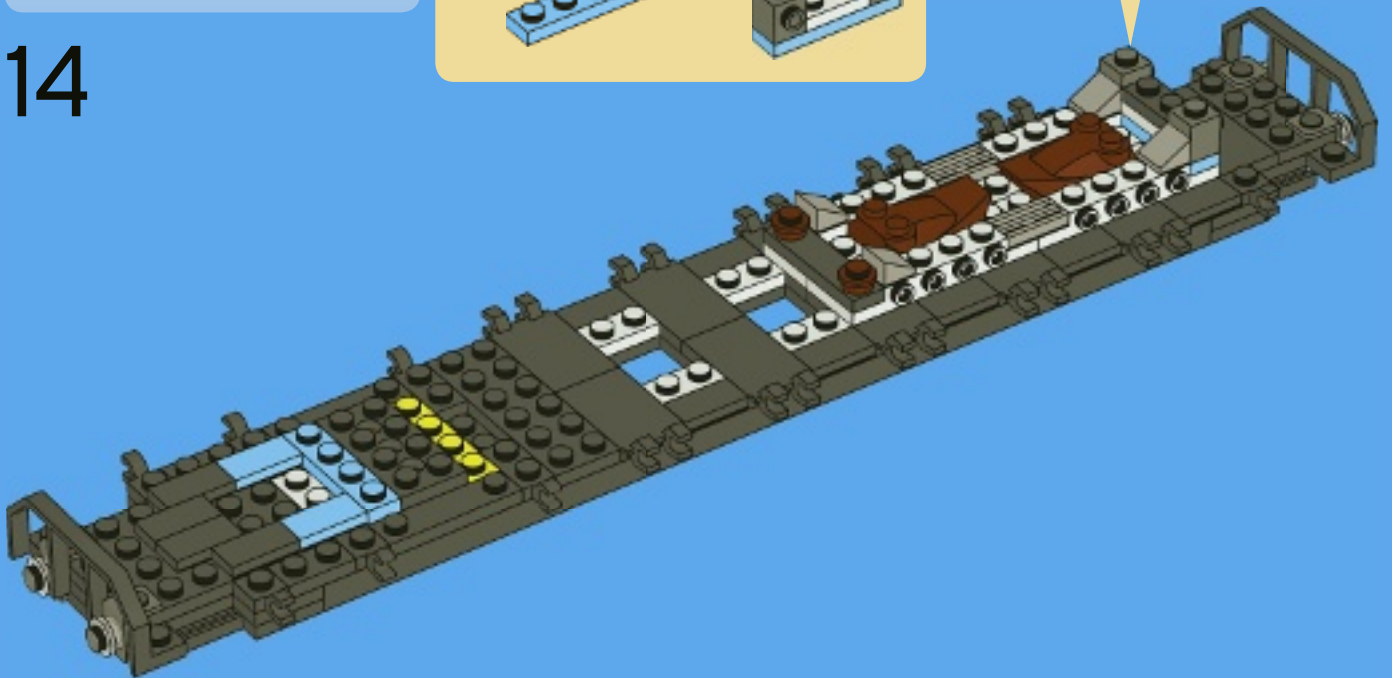
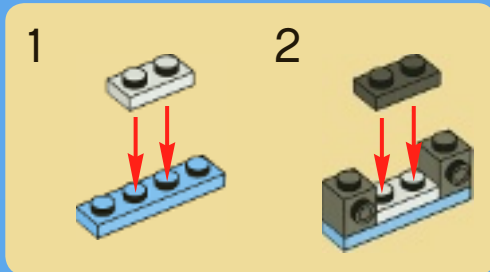

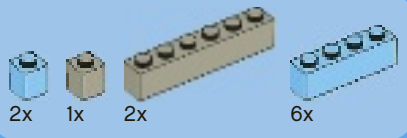

15

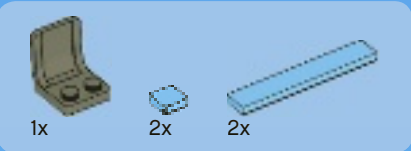
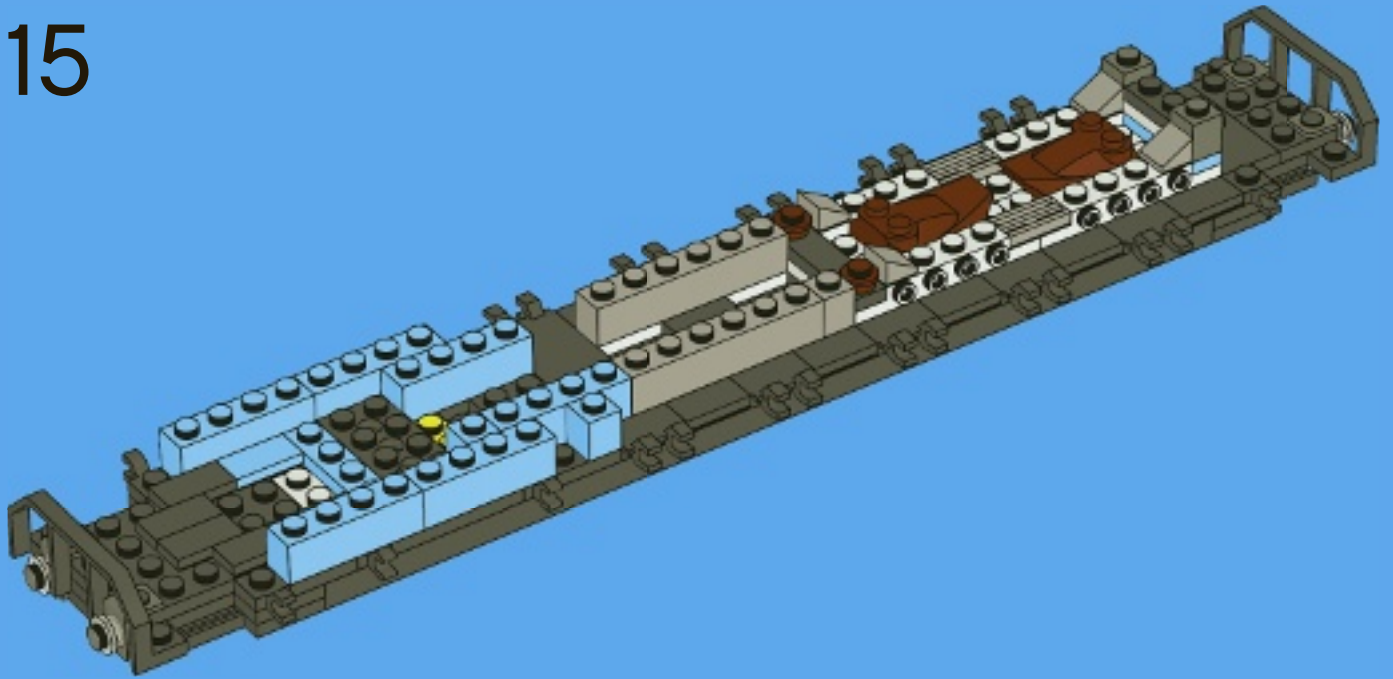

16

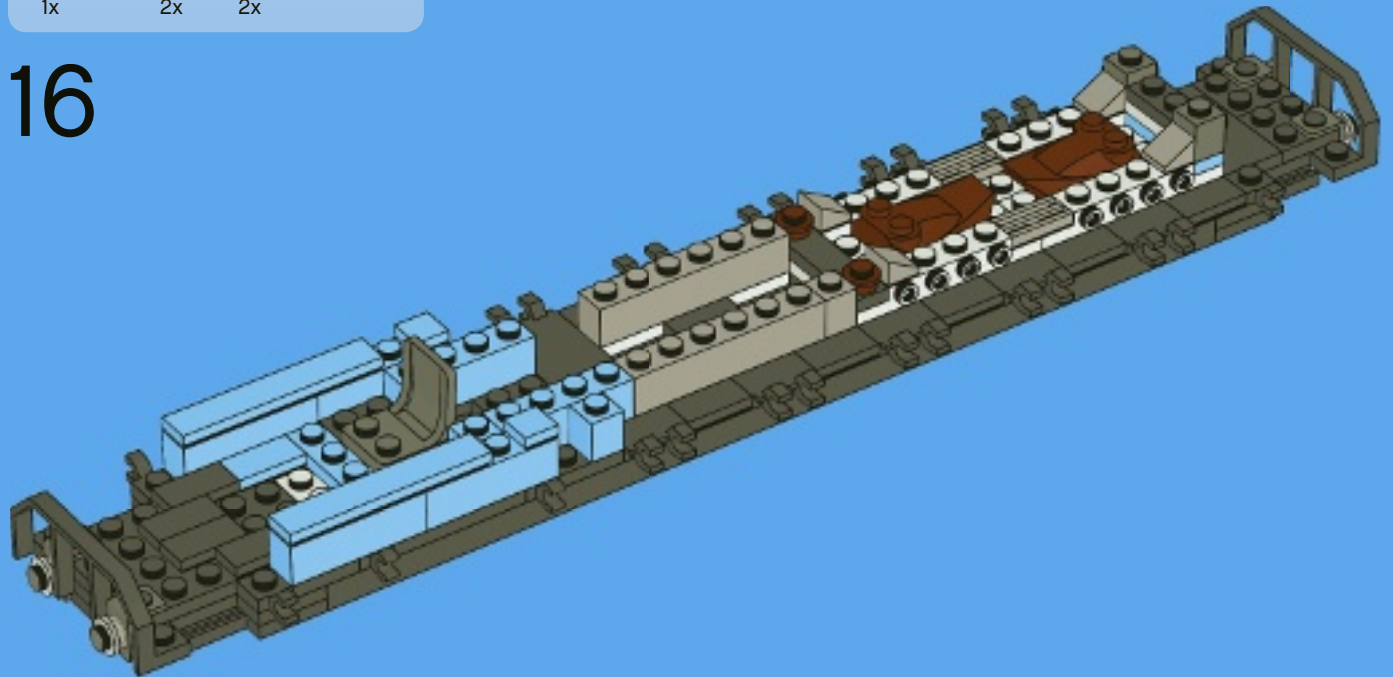

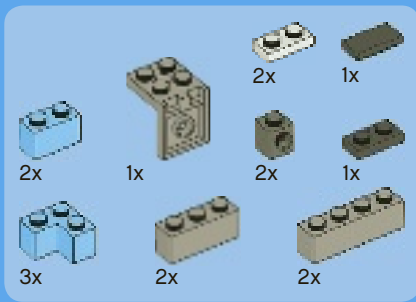

17

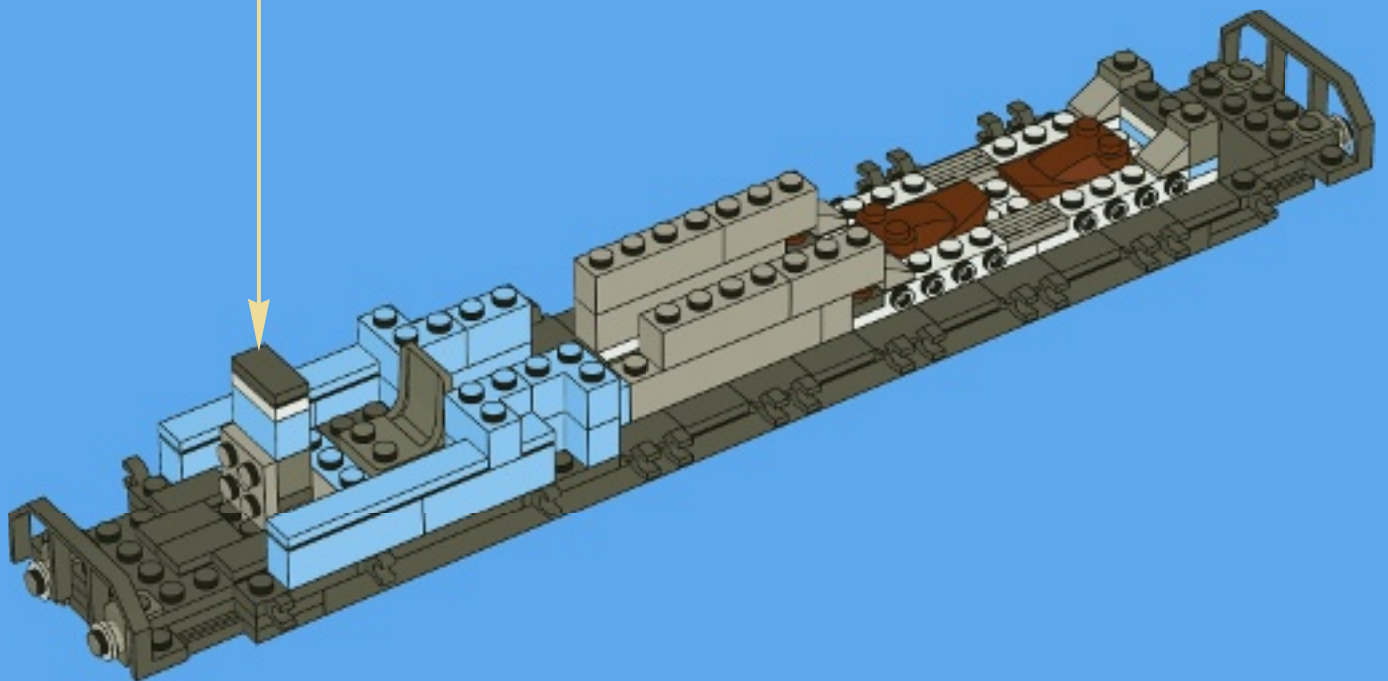
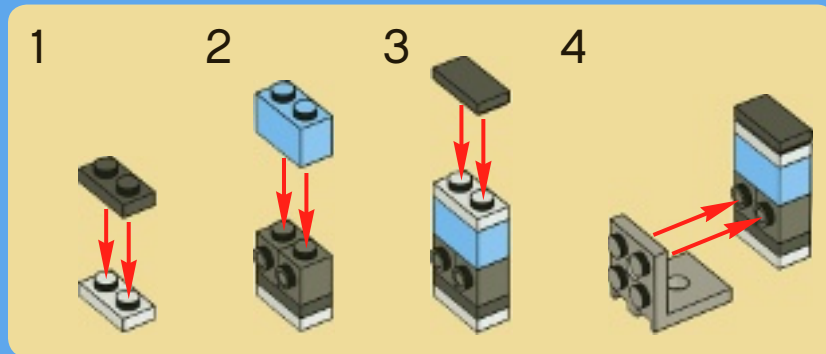

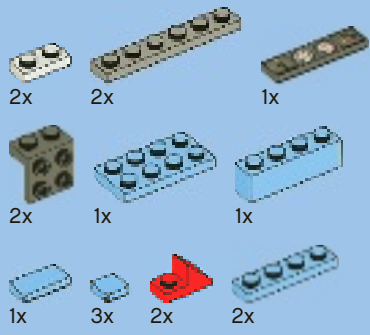

18

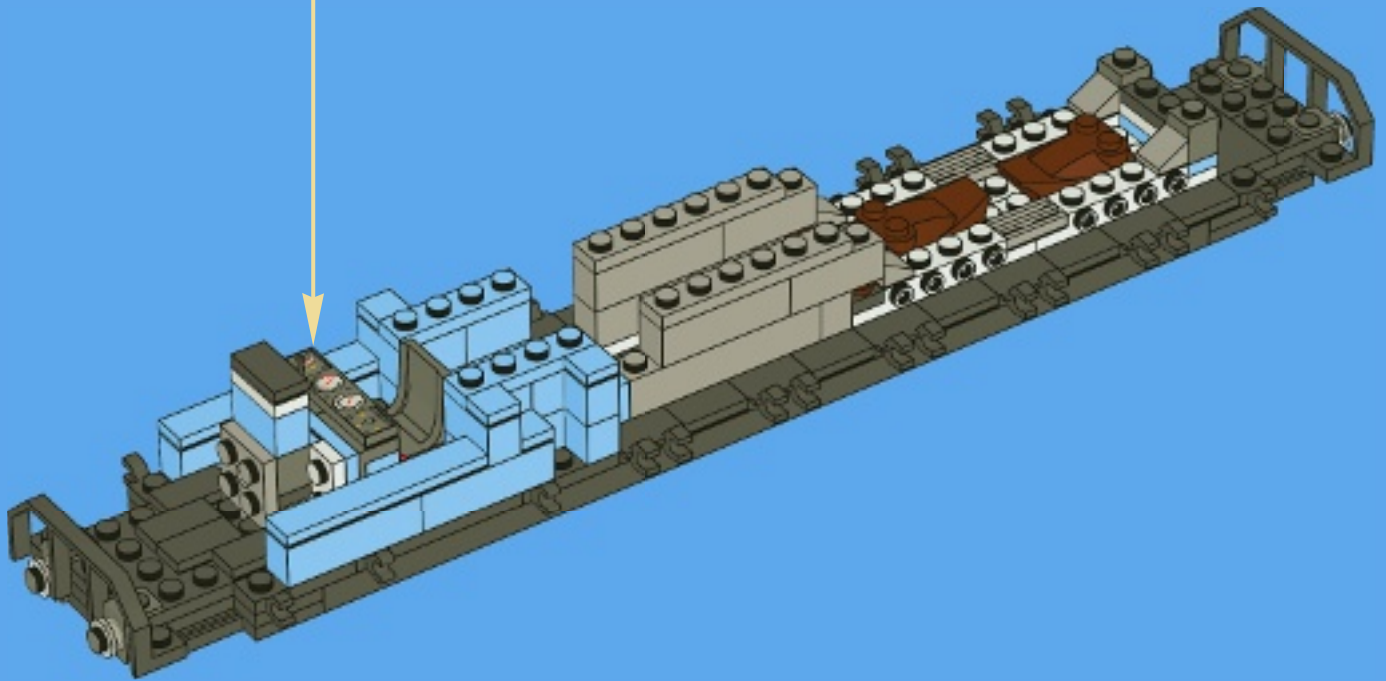
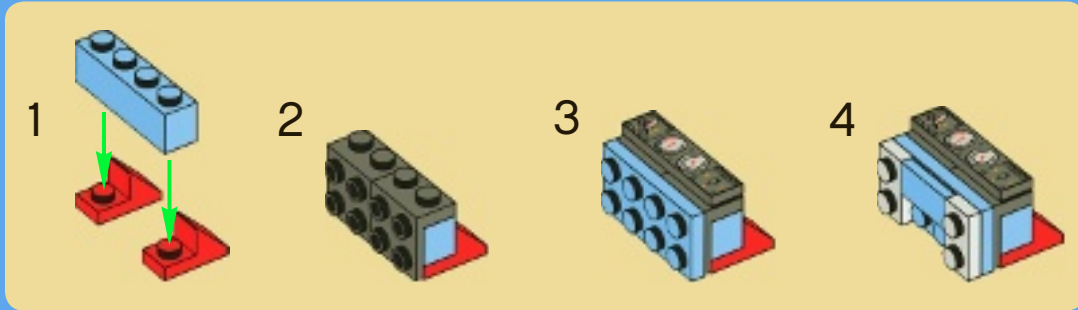



1



2

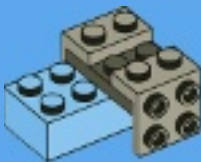

3

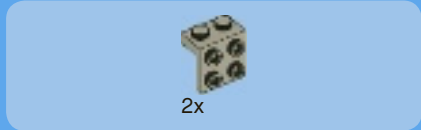
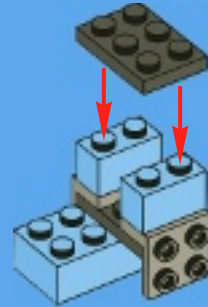

4

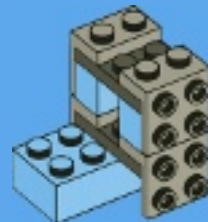



5

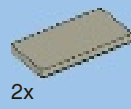
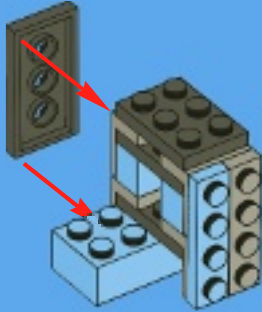

6

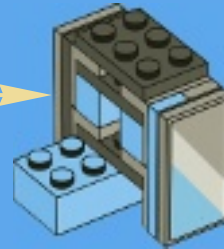
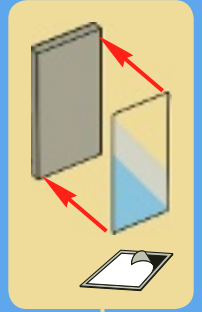
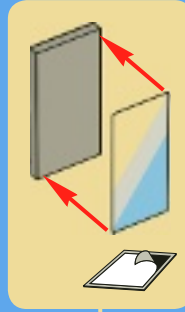

19

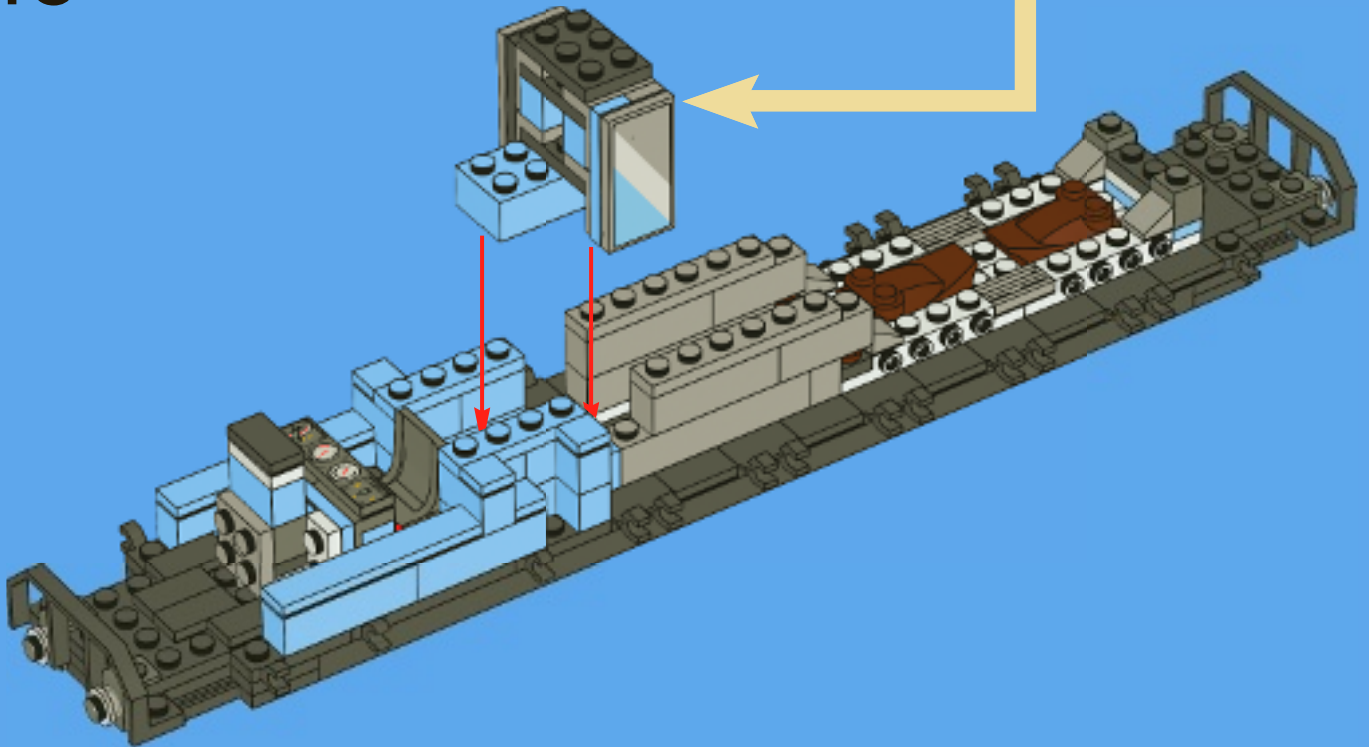



1x



1x



3x

20

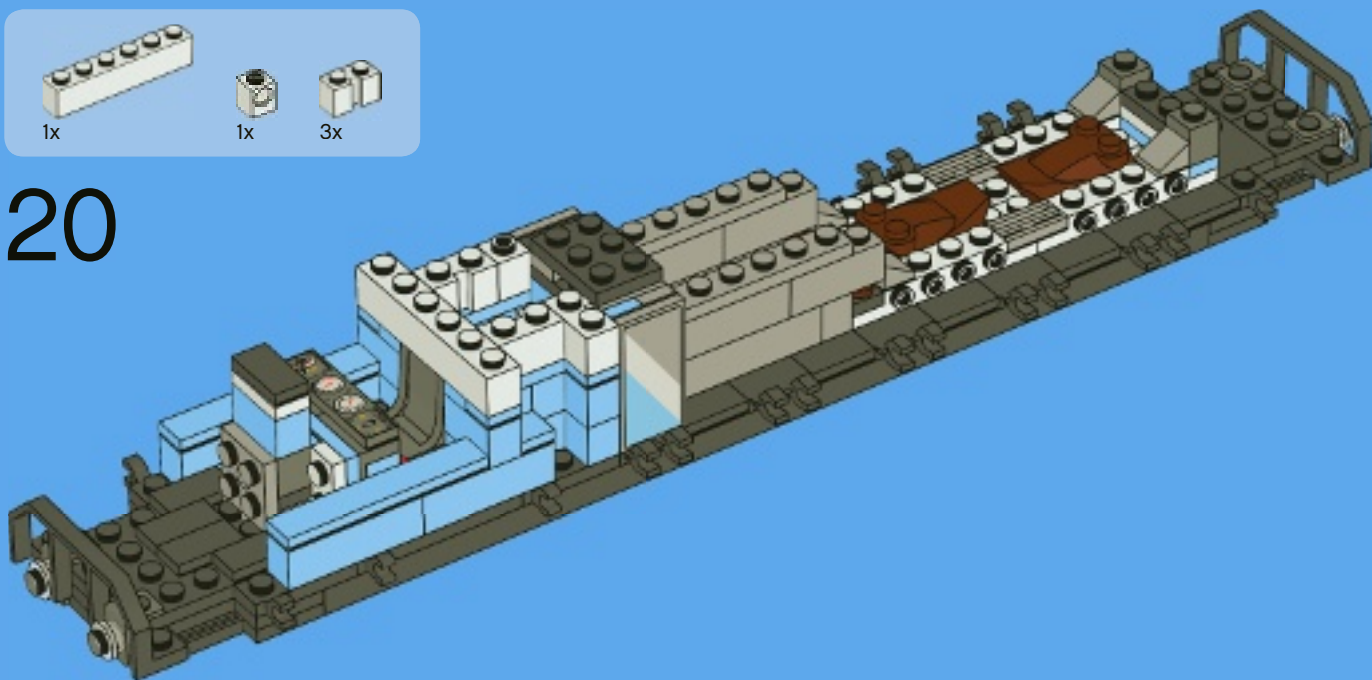

1x



1x



1x



1x



1x

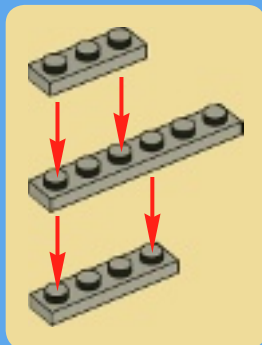

21

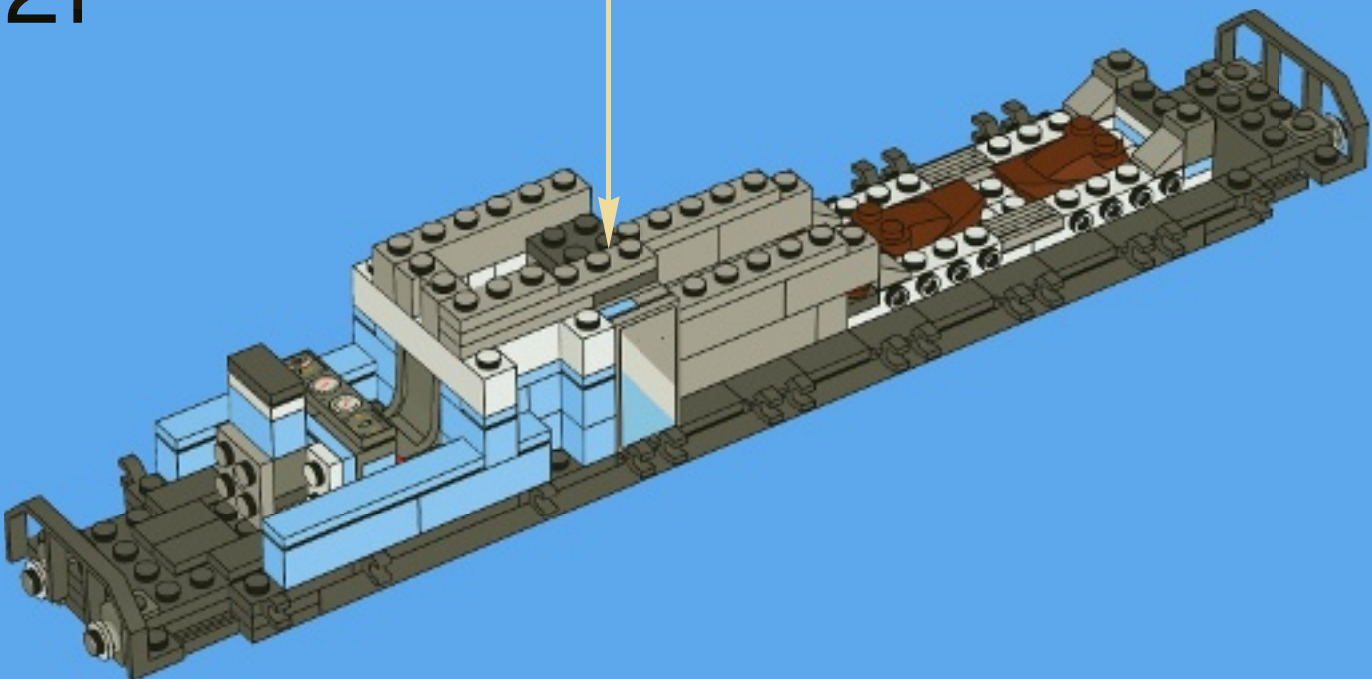



22

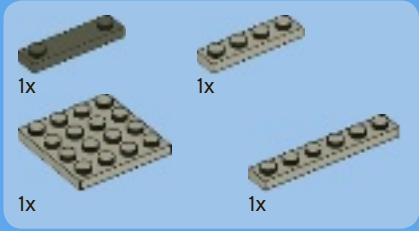
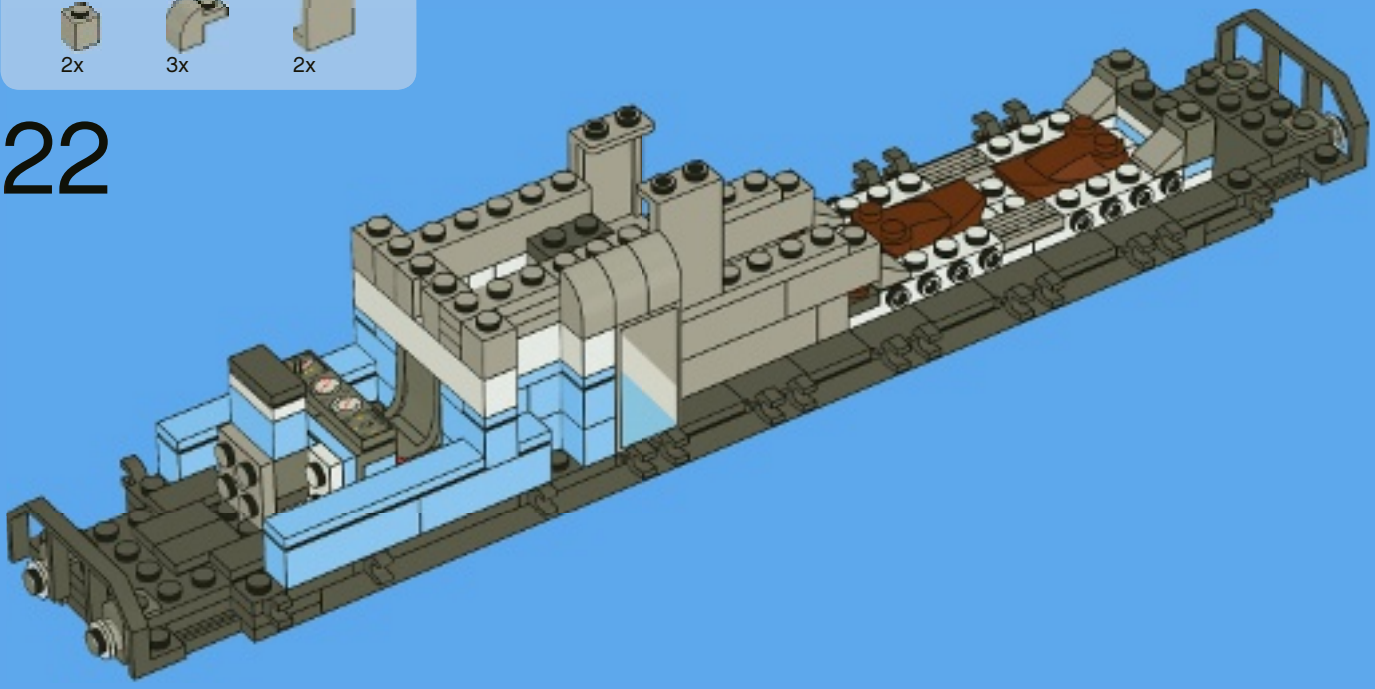

23

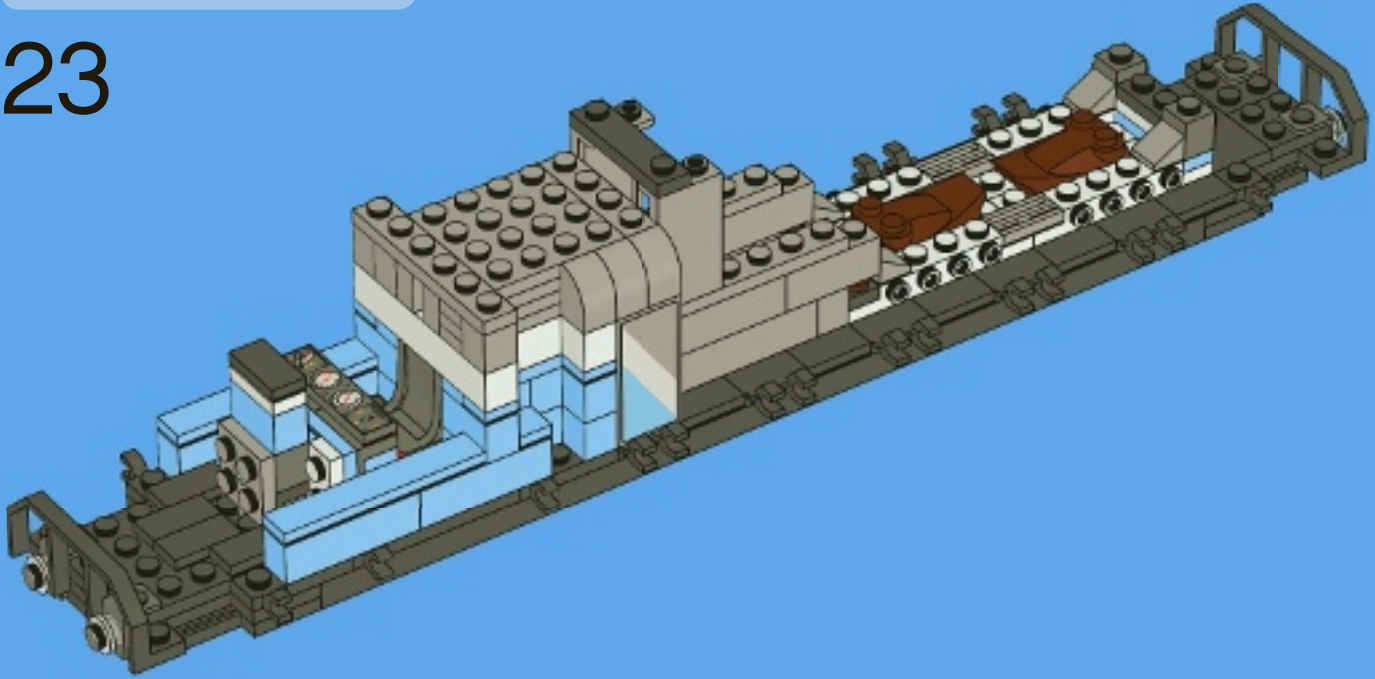



1x



1x

24

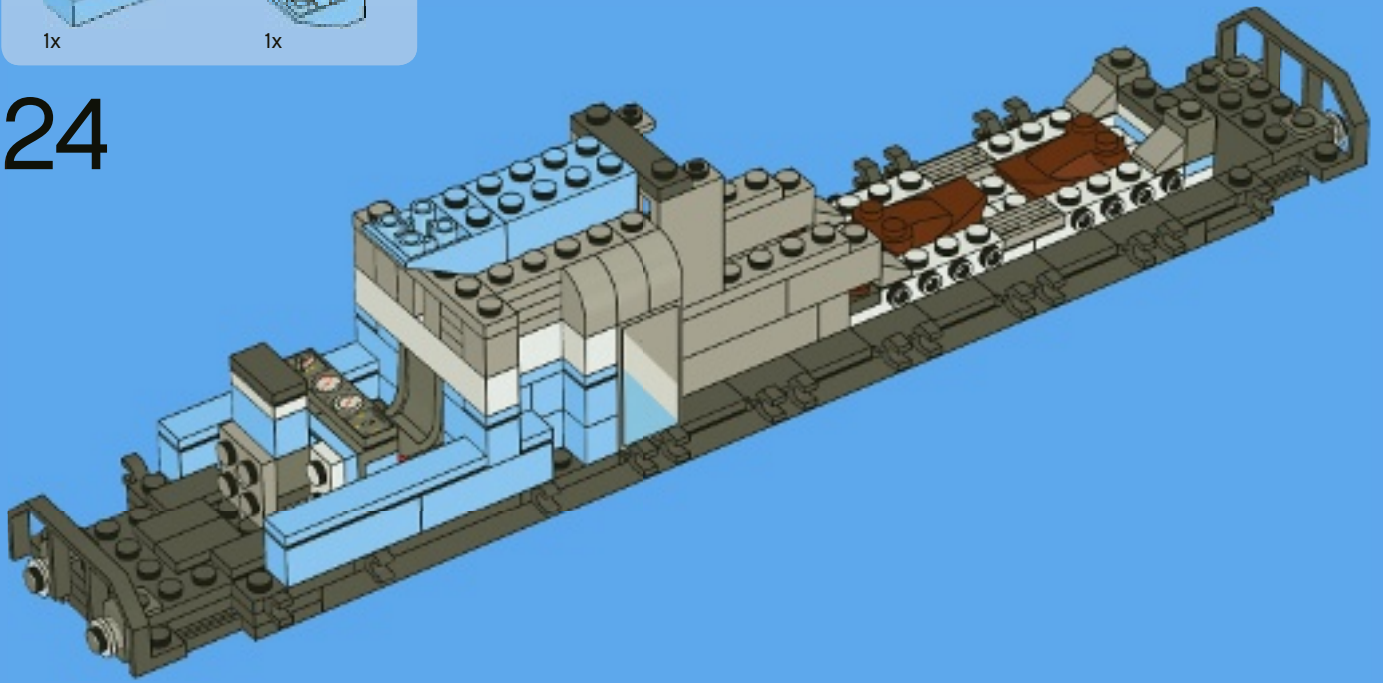

4x



2x



2x

25

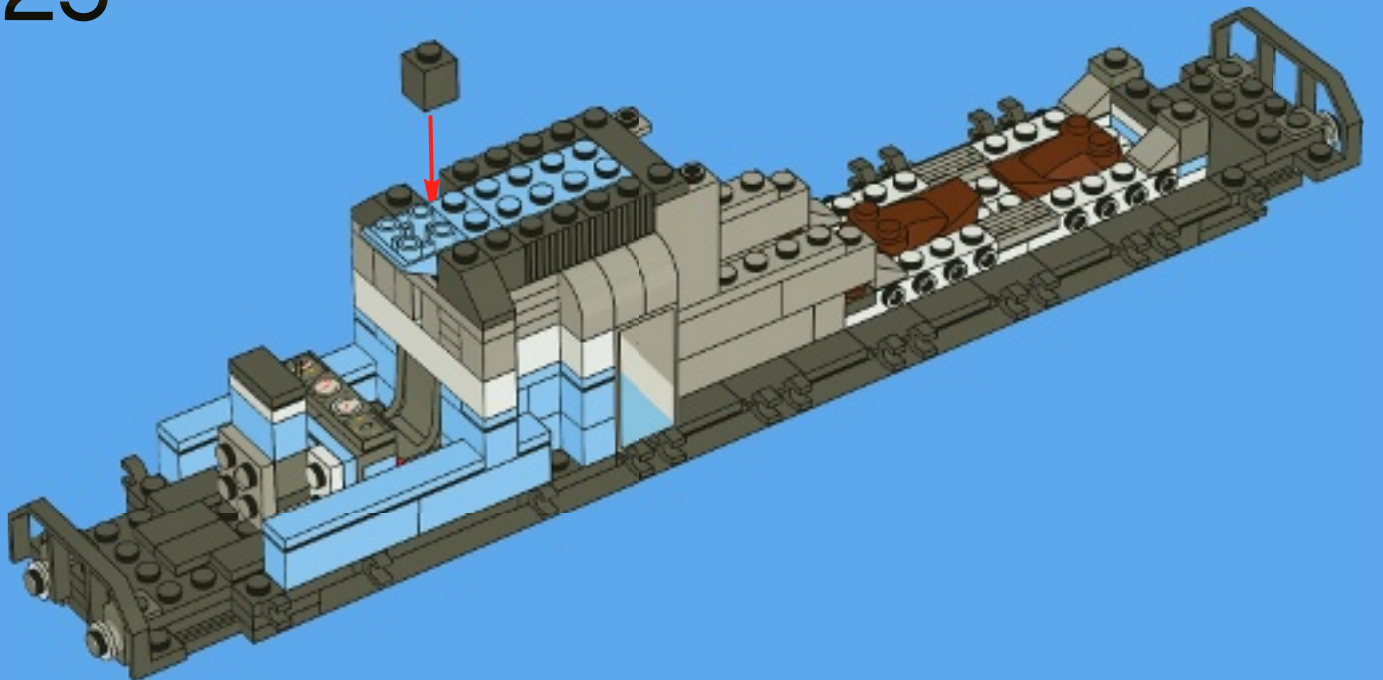

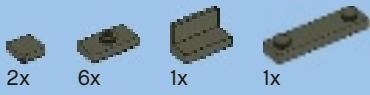

26

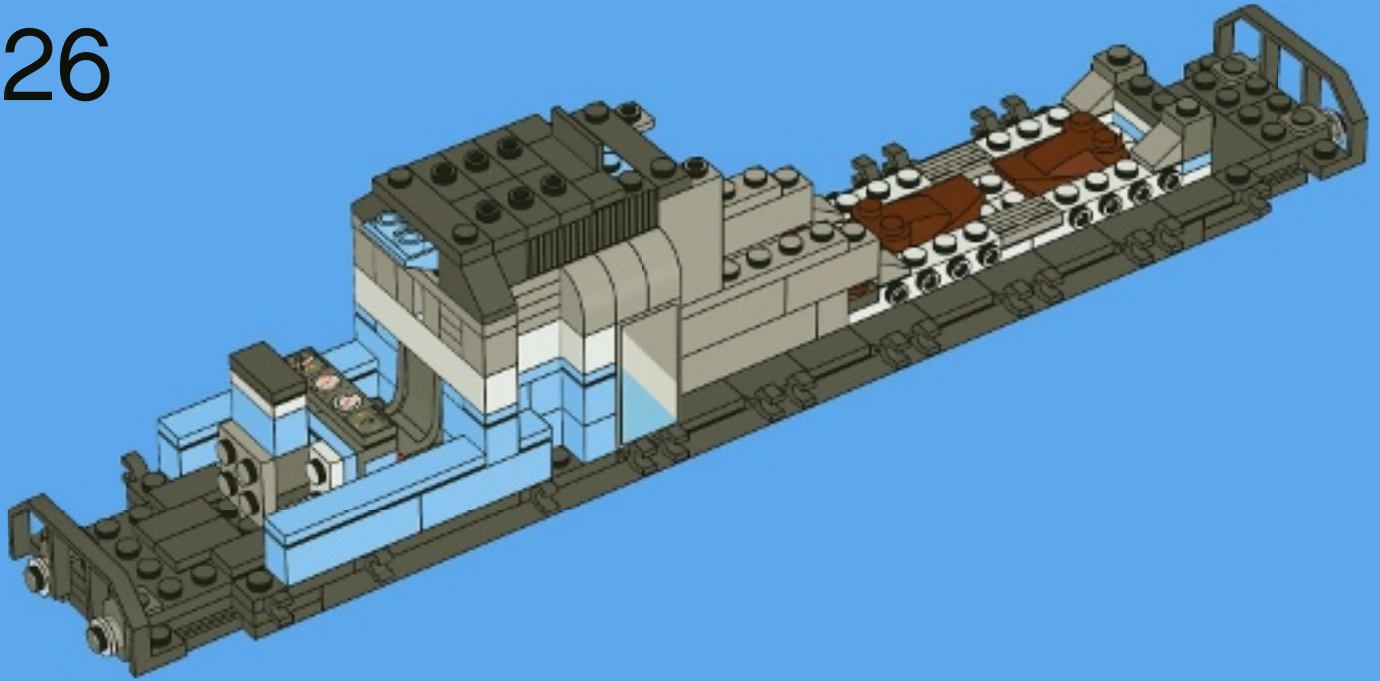

27

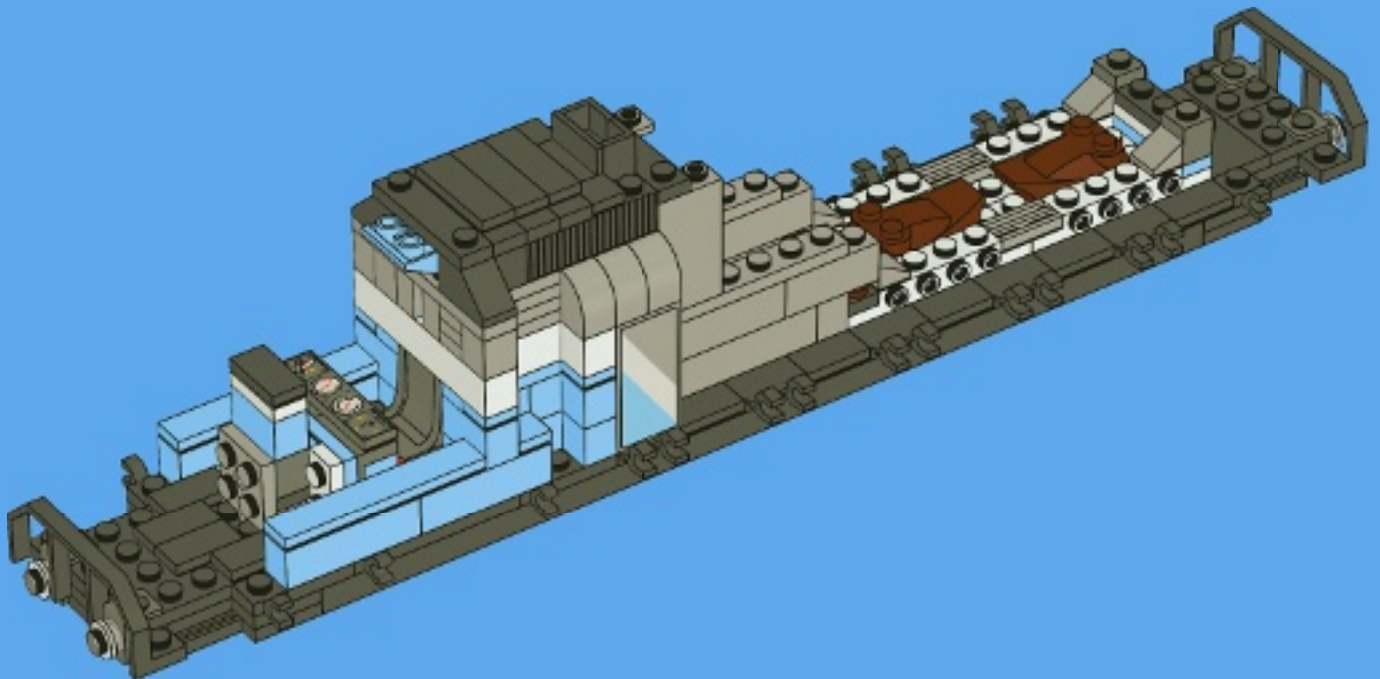



28

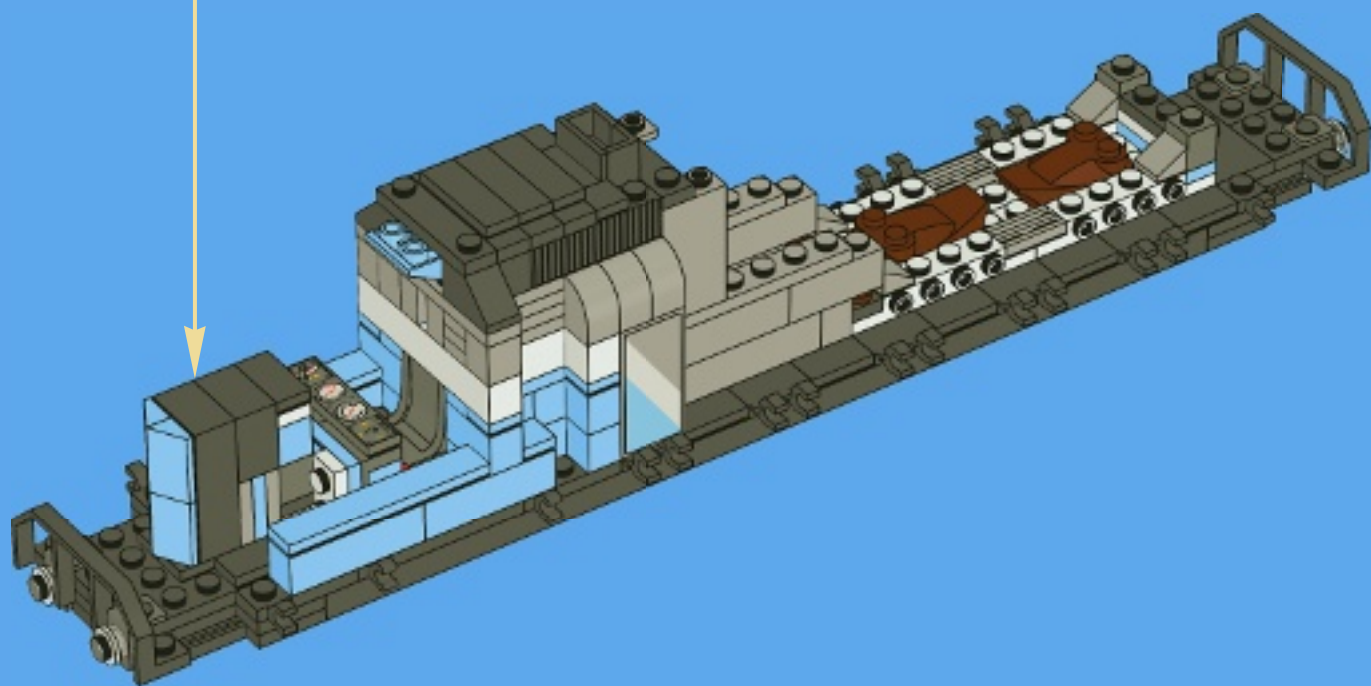
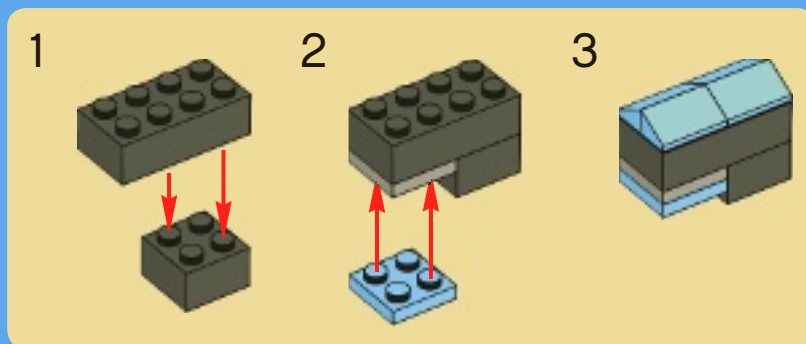

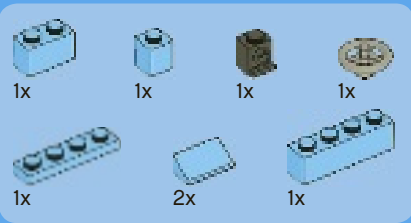

29

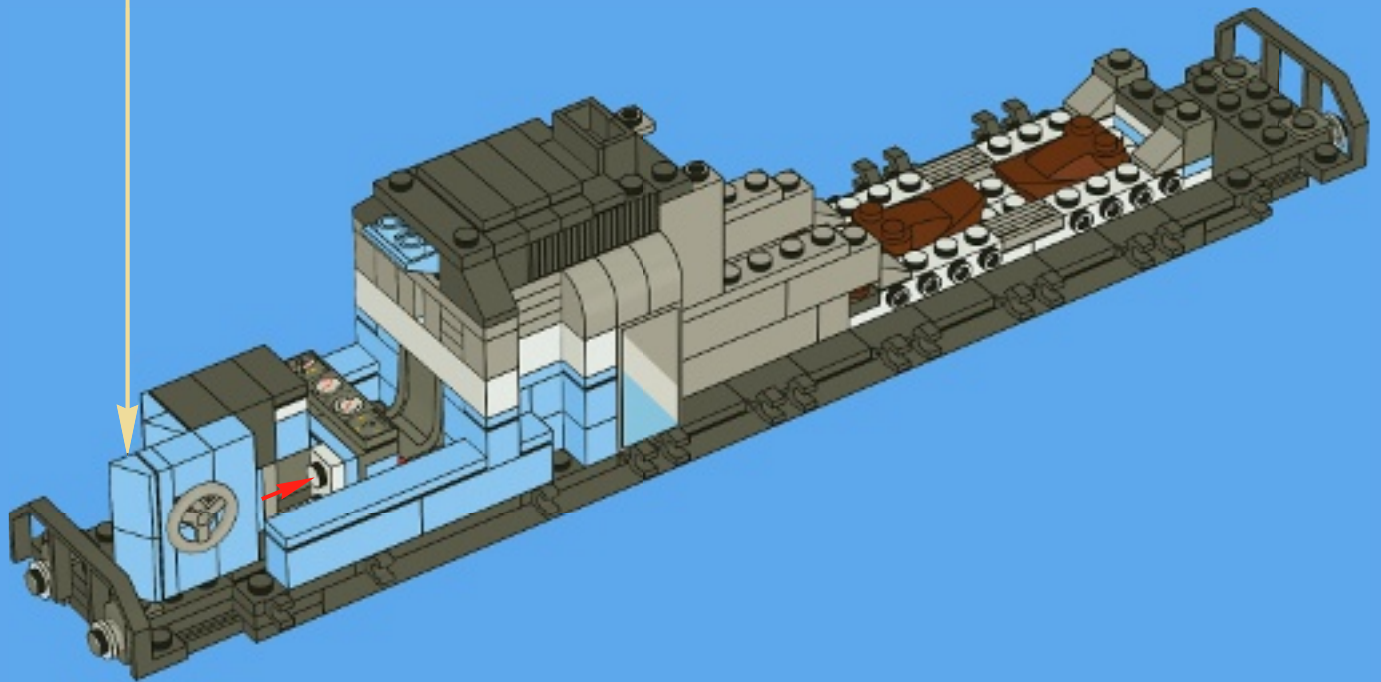
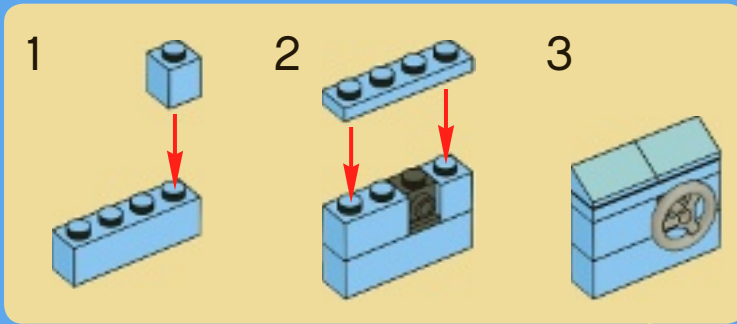

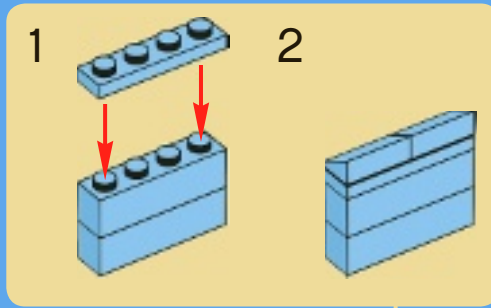
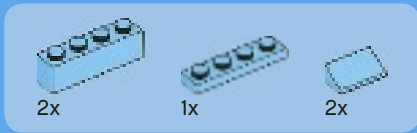

30

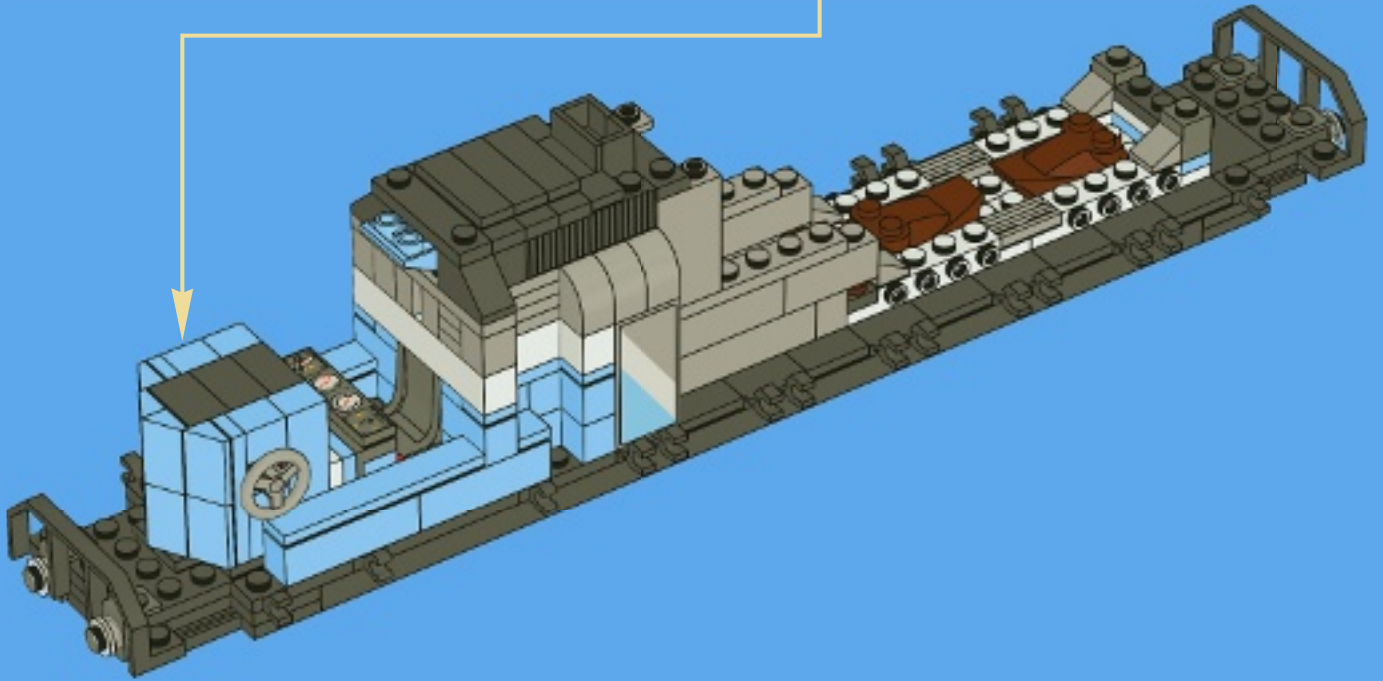

31

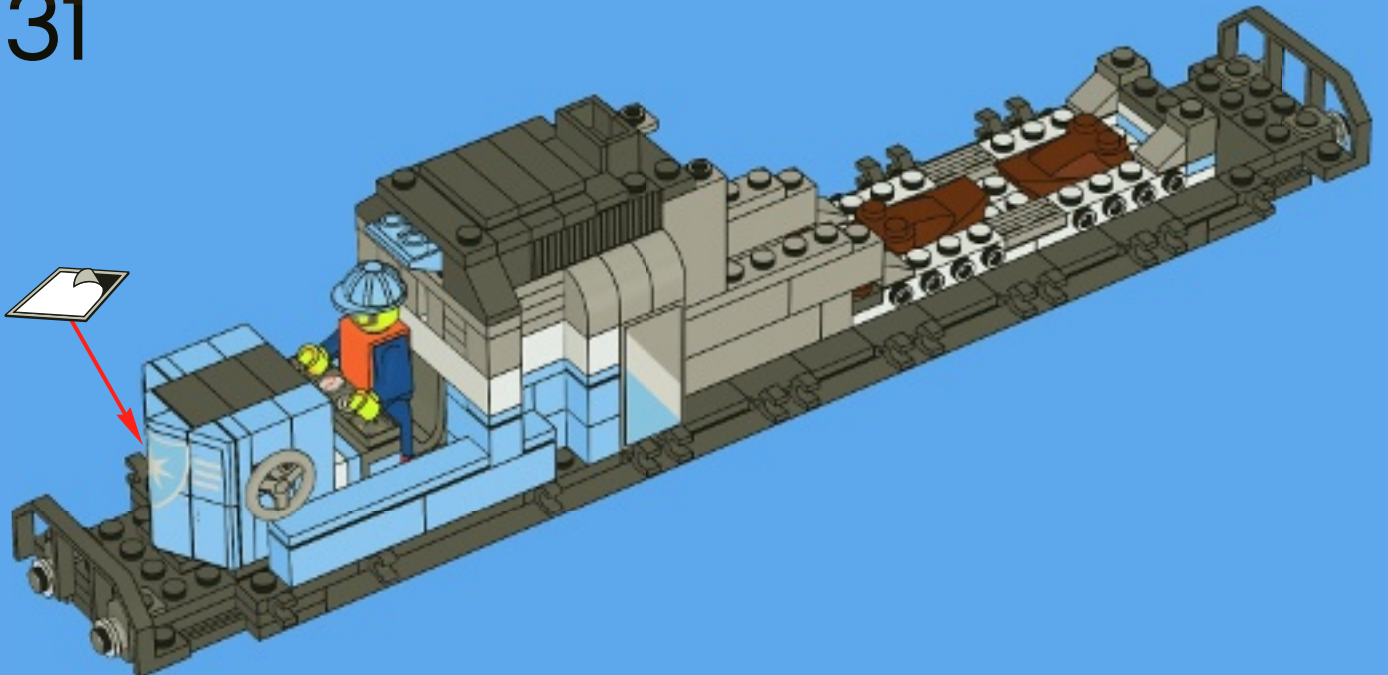

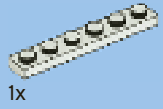

1x



1x

1

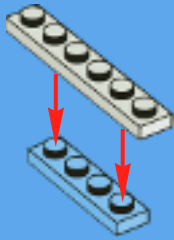

2x

2

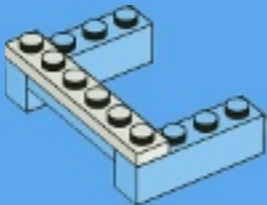

2x

3

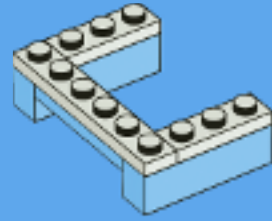

6x

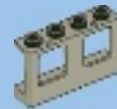

3x

4

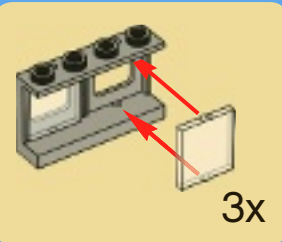

3x

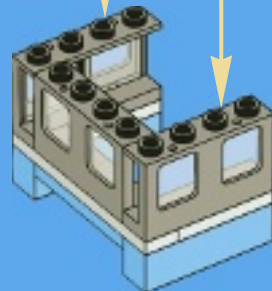



5

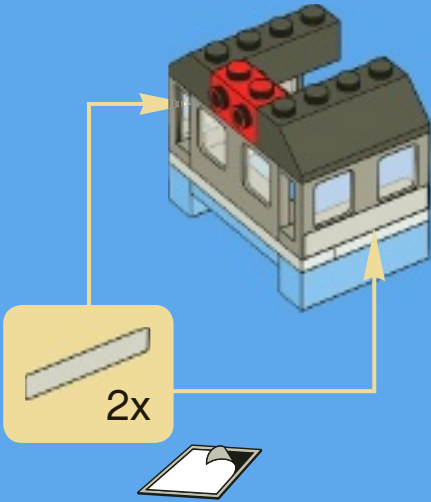

2x

1x

6

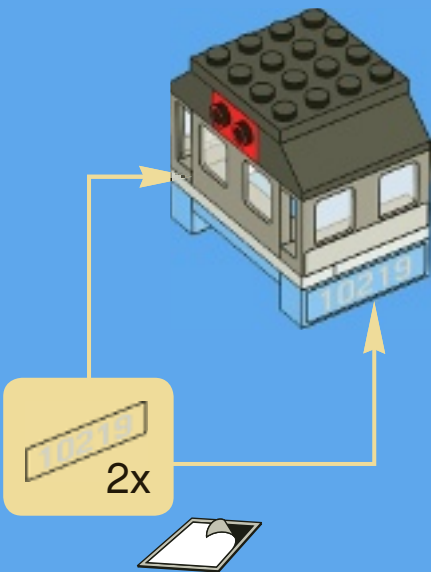

2x

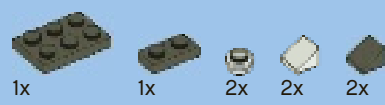

7



1

2

3

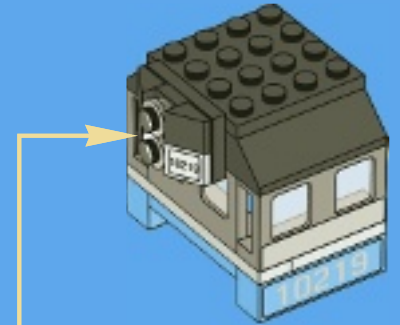

2x

2x

8

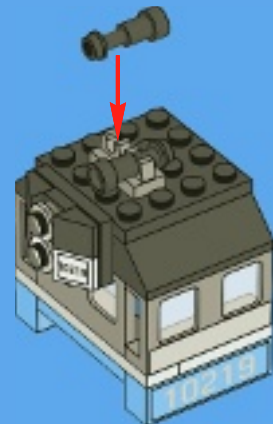

32

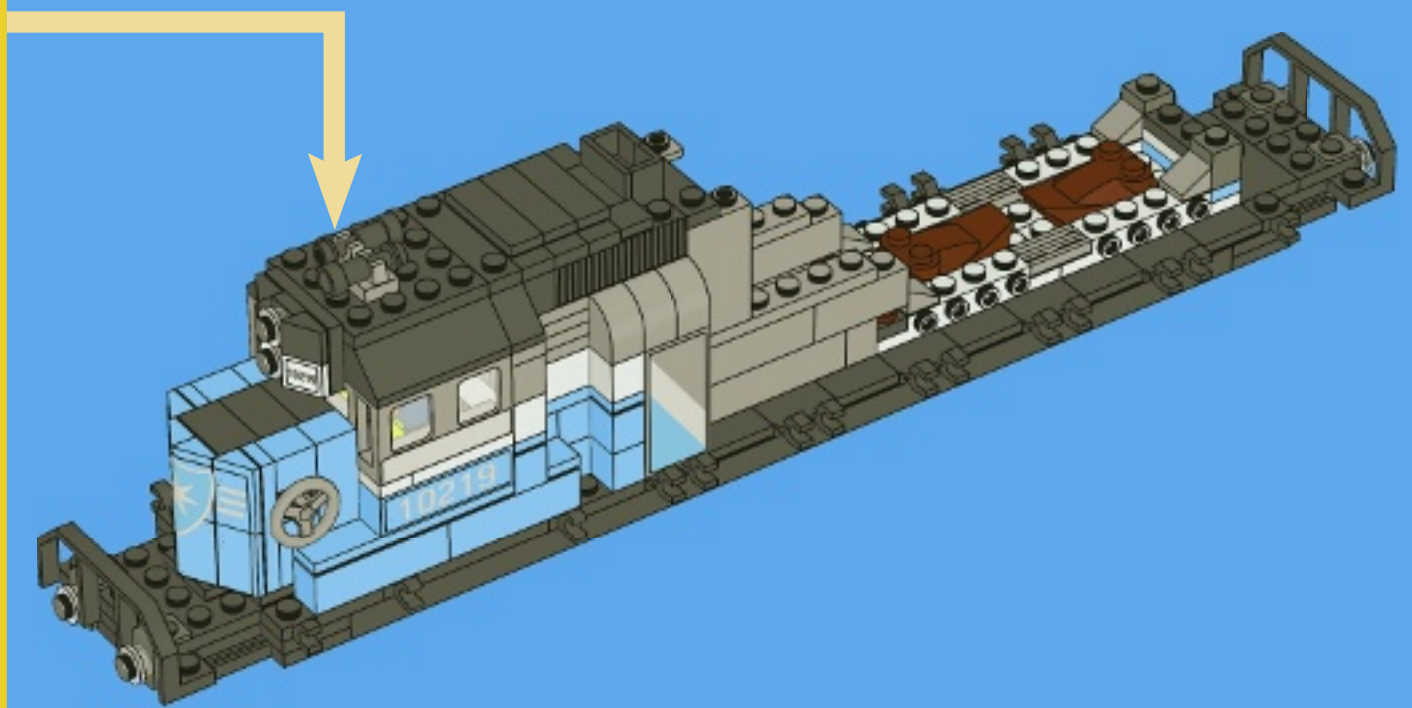

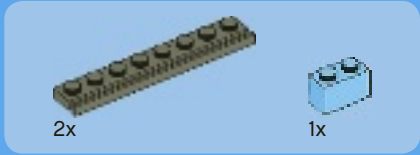
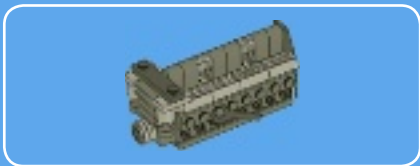

1

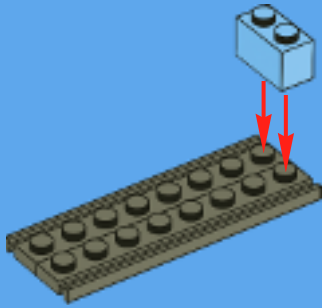

2

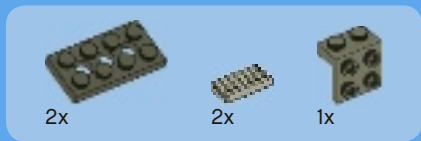
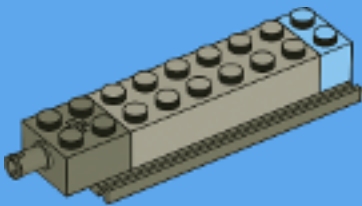

3

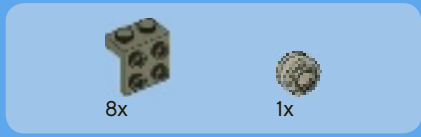
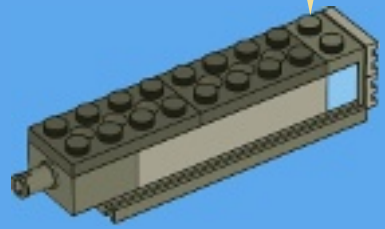
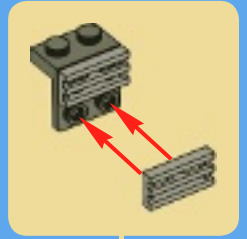

4

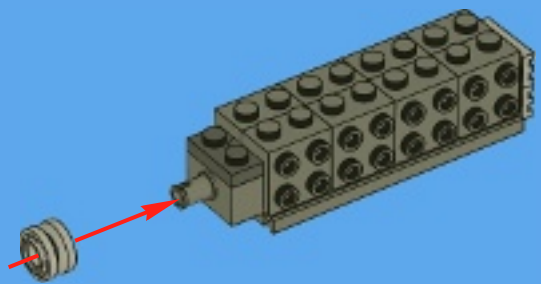



5

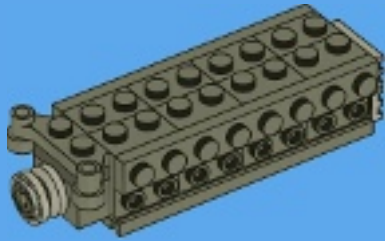

7

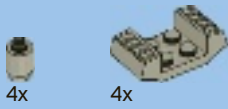
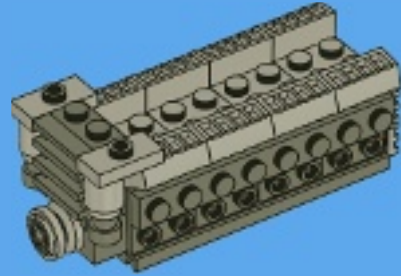

6

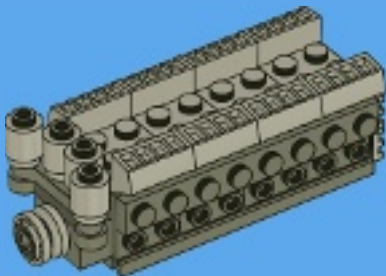

8

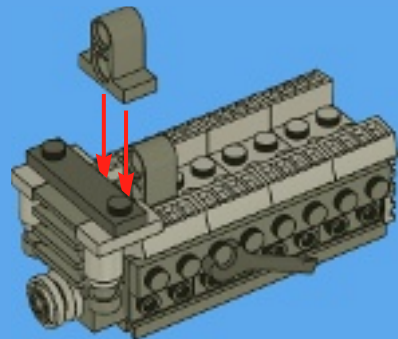



2x



4x



1x

9

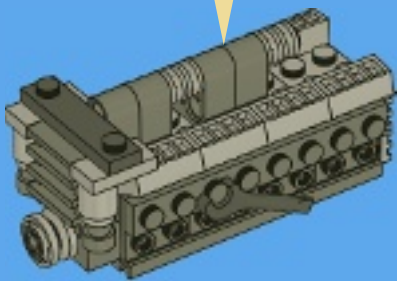
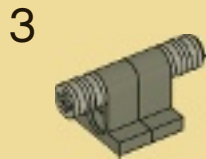
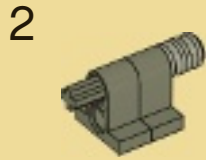
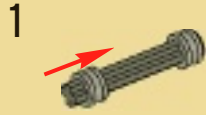

1x

10

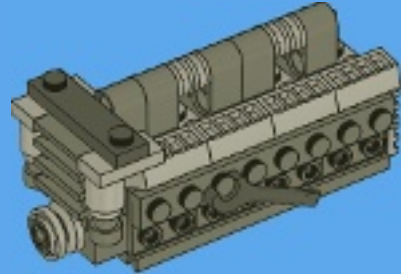

1x



2x



1x

11

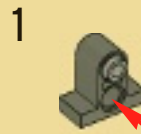

1



2

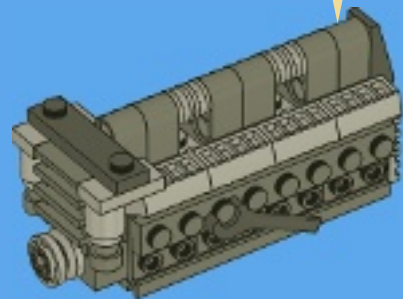

33

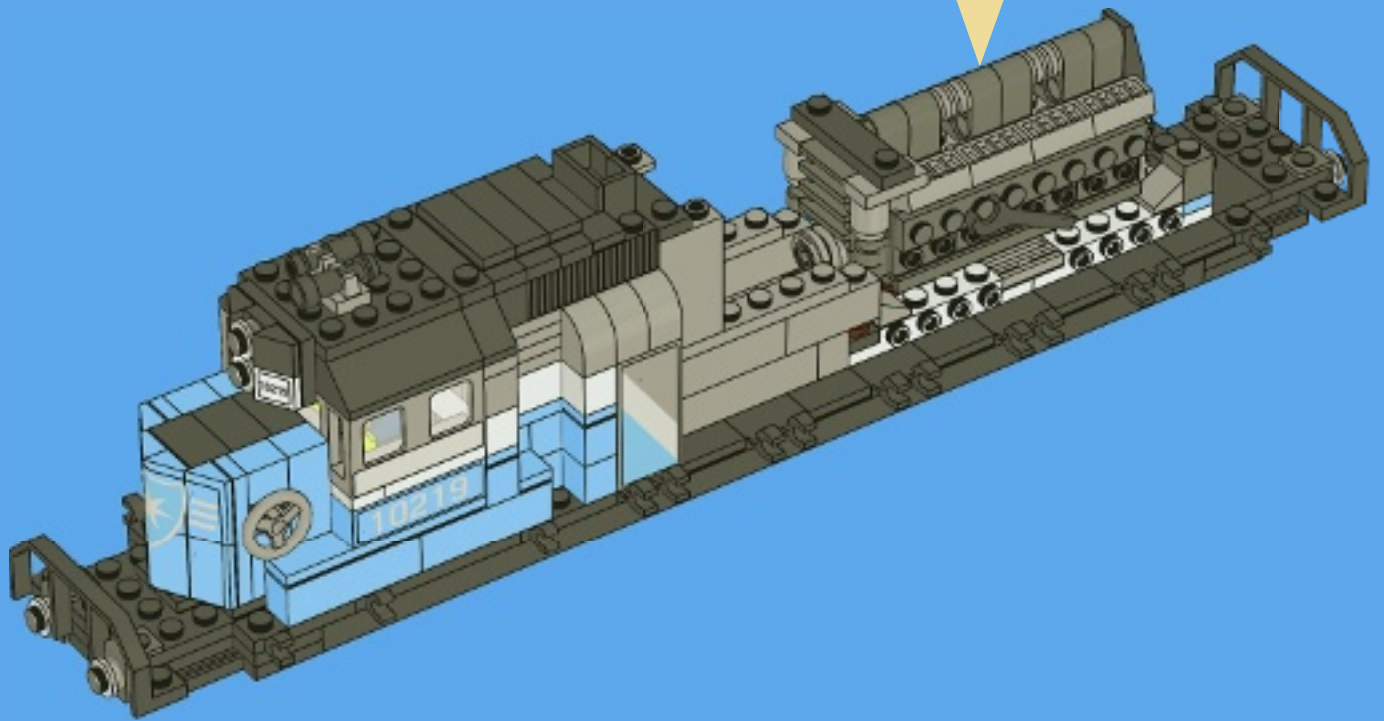



2x

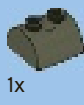

1x

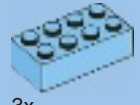

3x

34

1

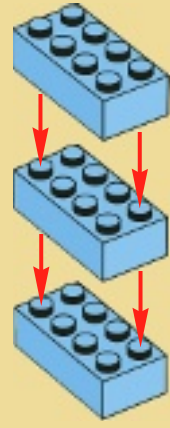

2

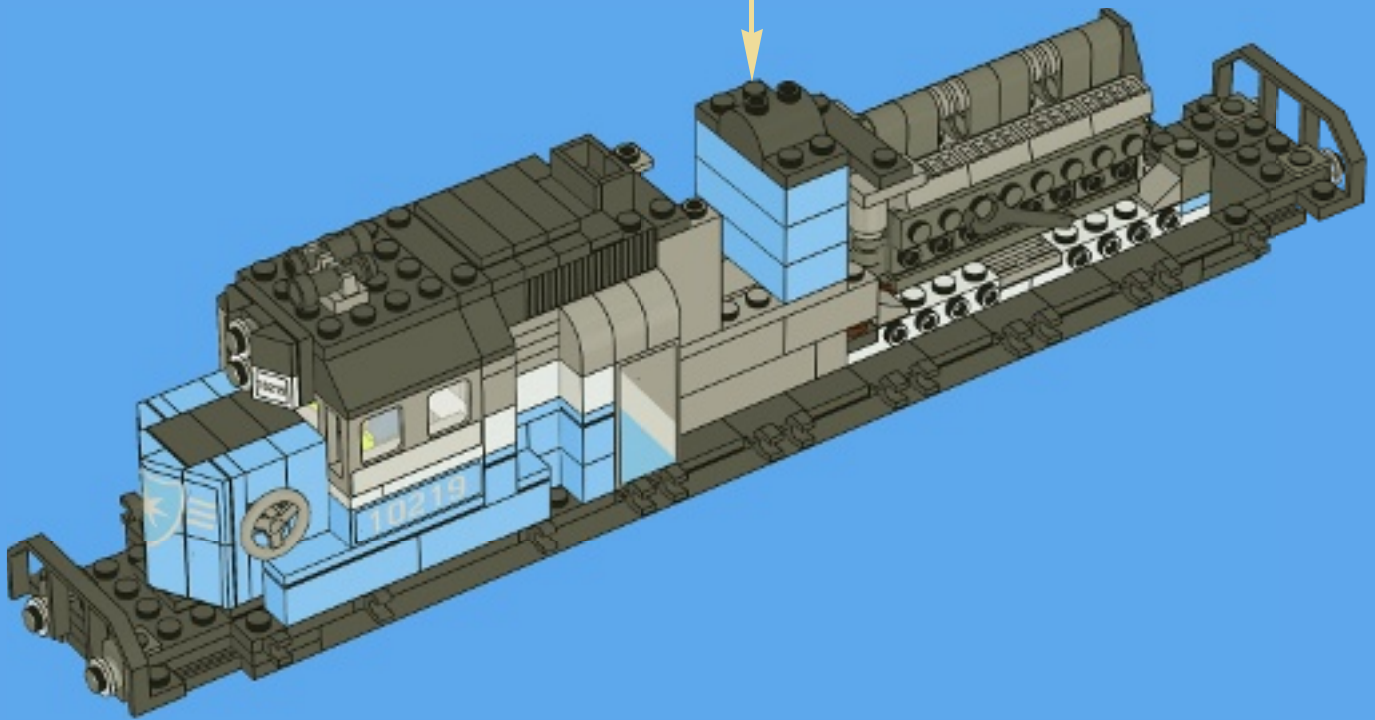
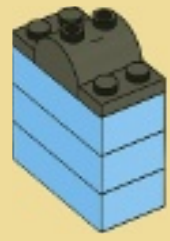



2x



3x

35

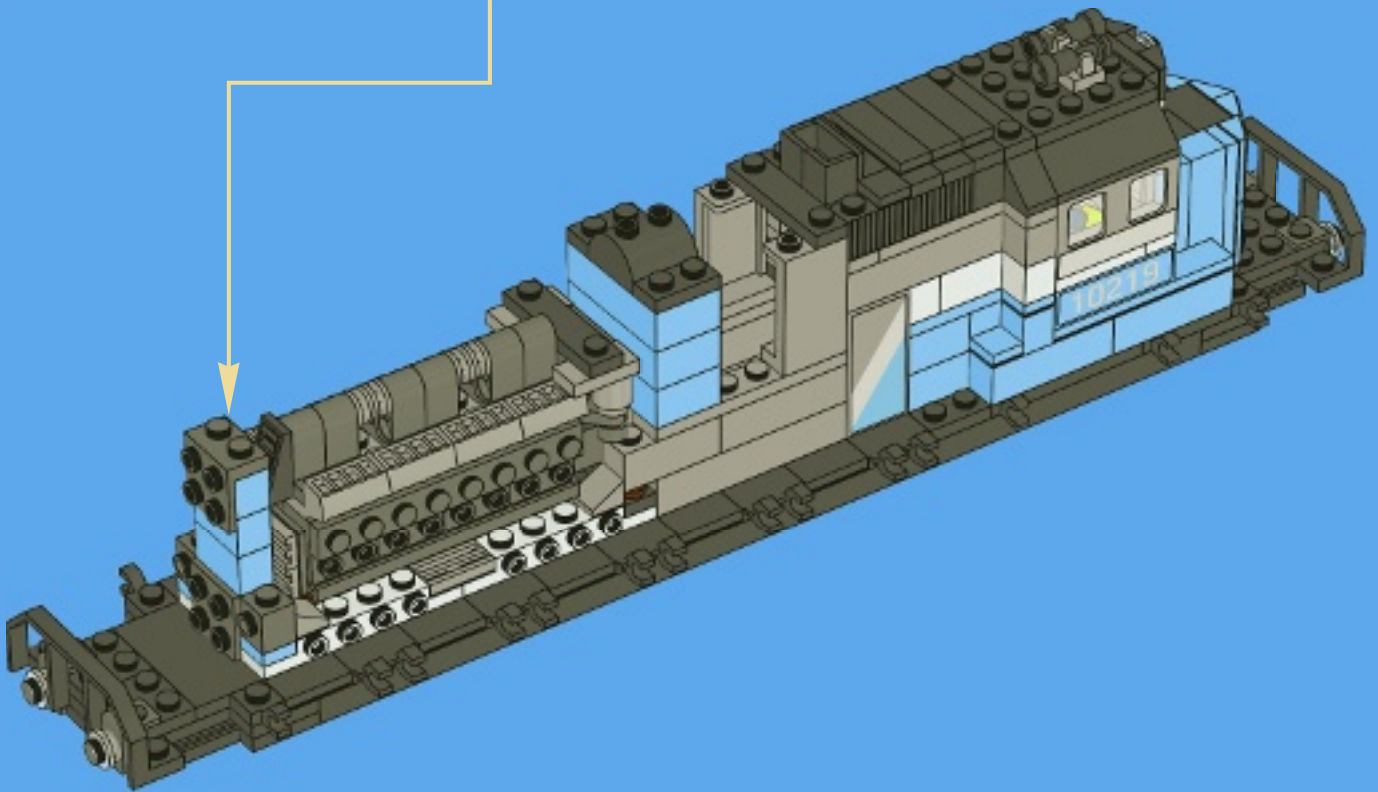
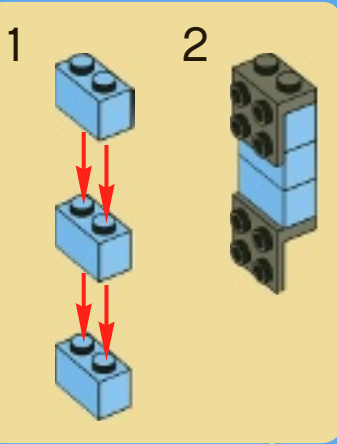



4x



4x

36

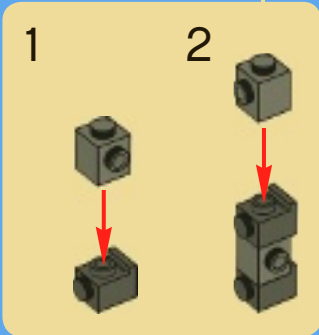
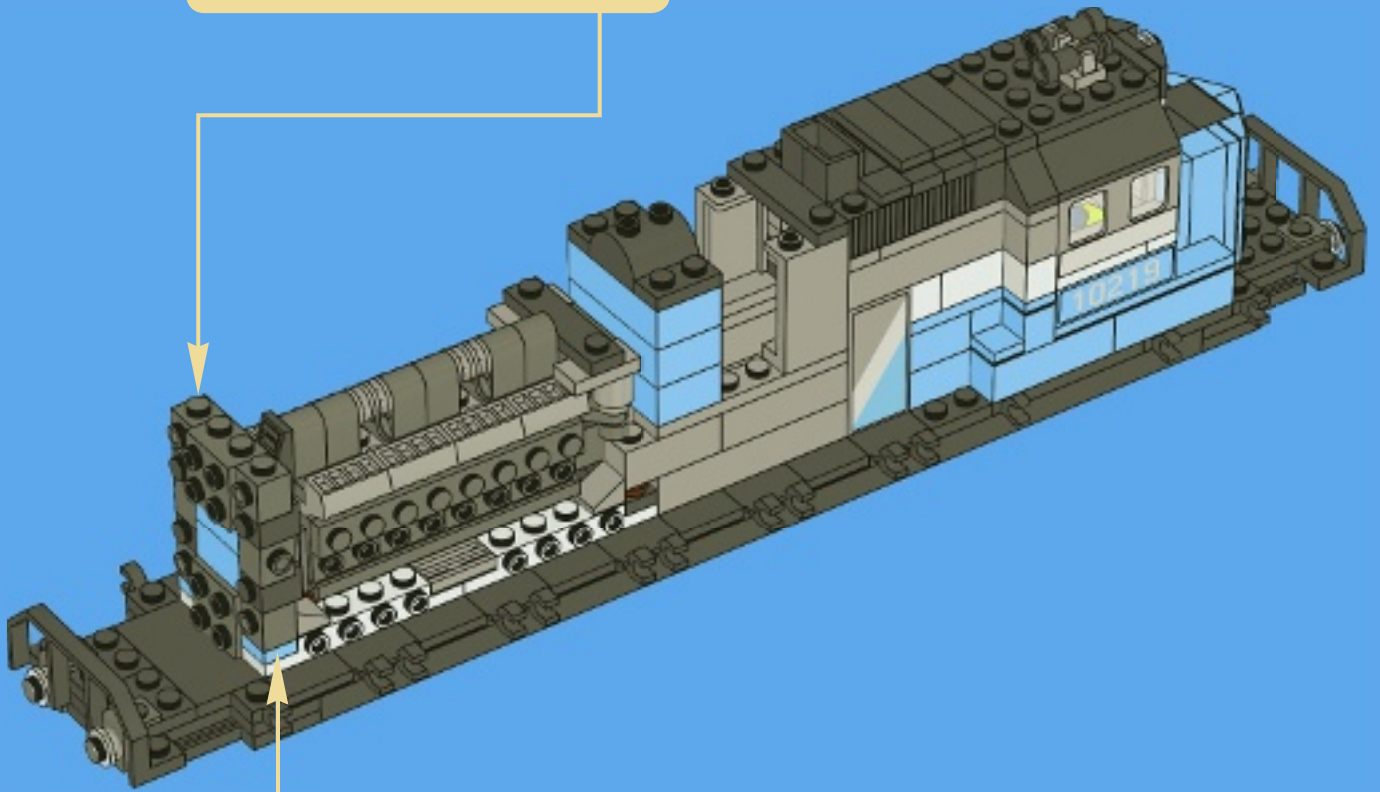
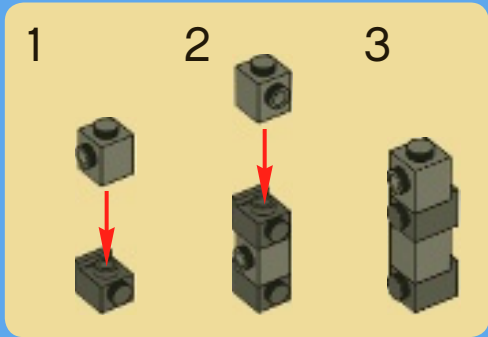



2x



1x

37

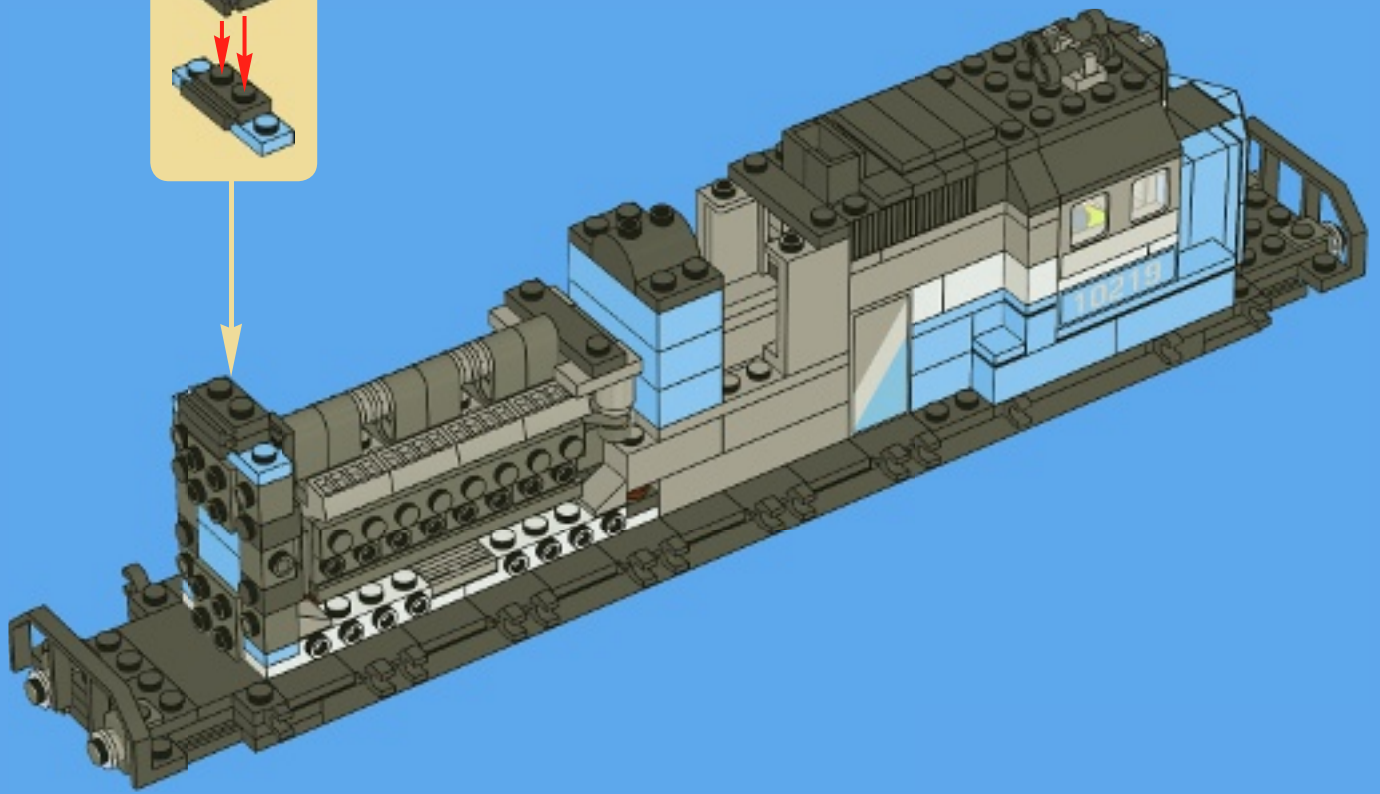
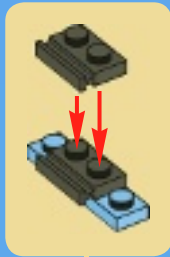

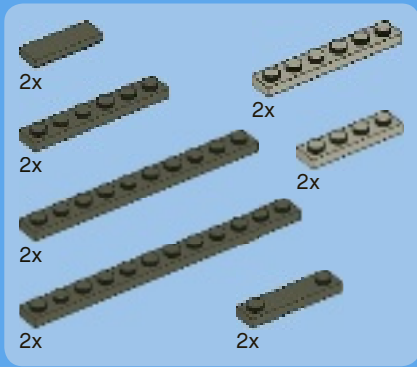

38

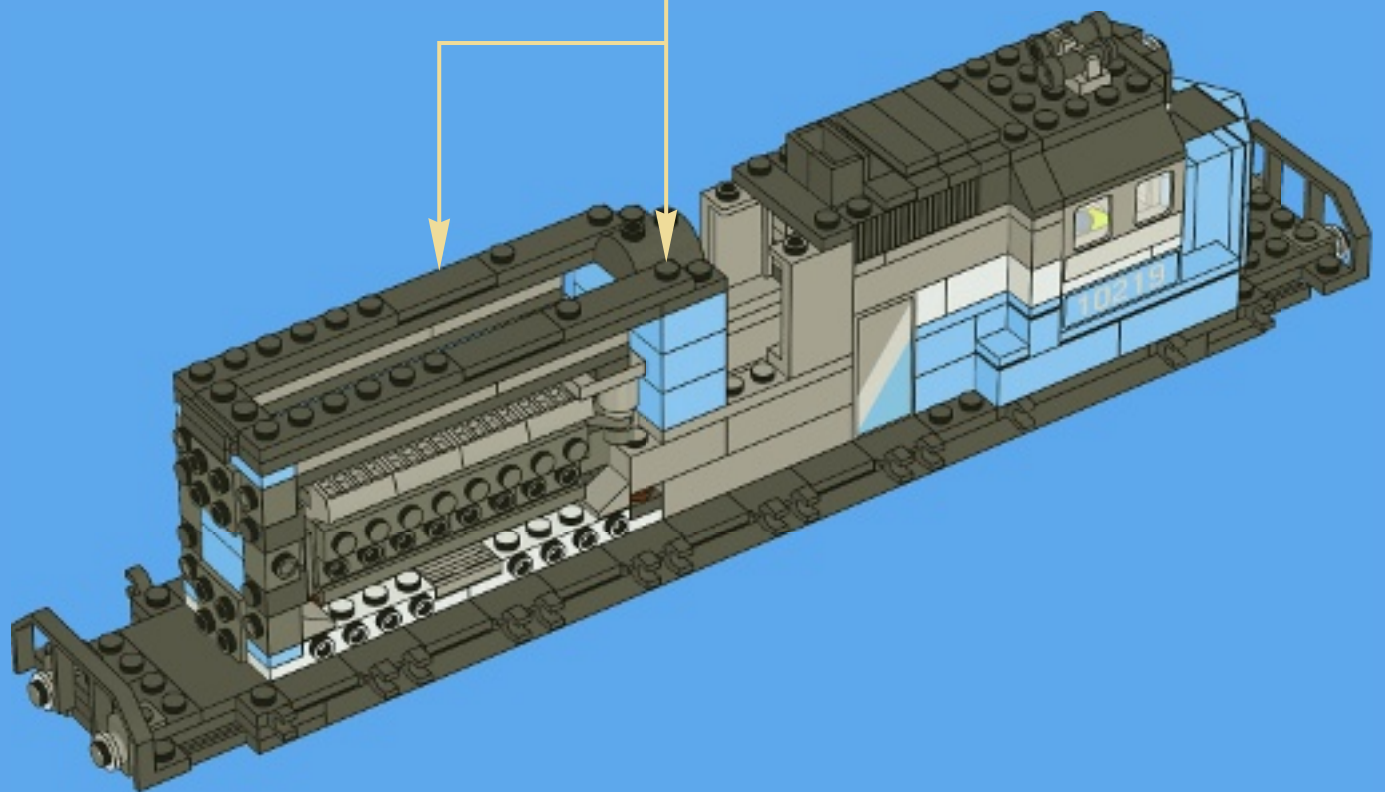
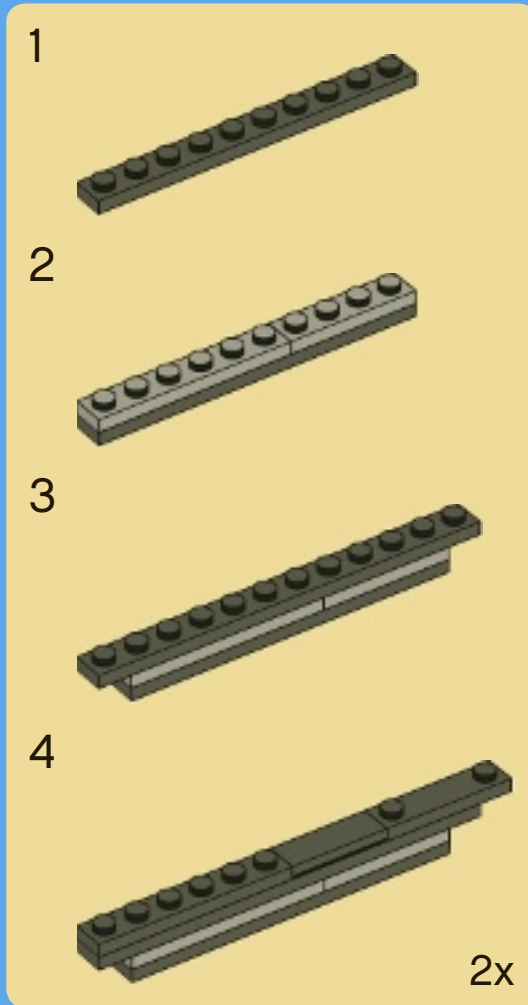

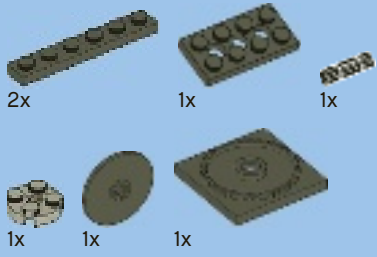

39

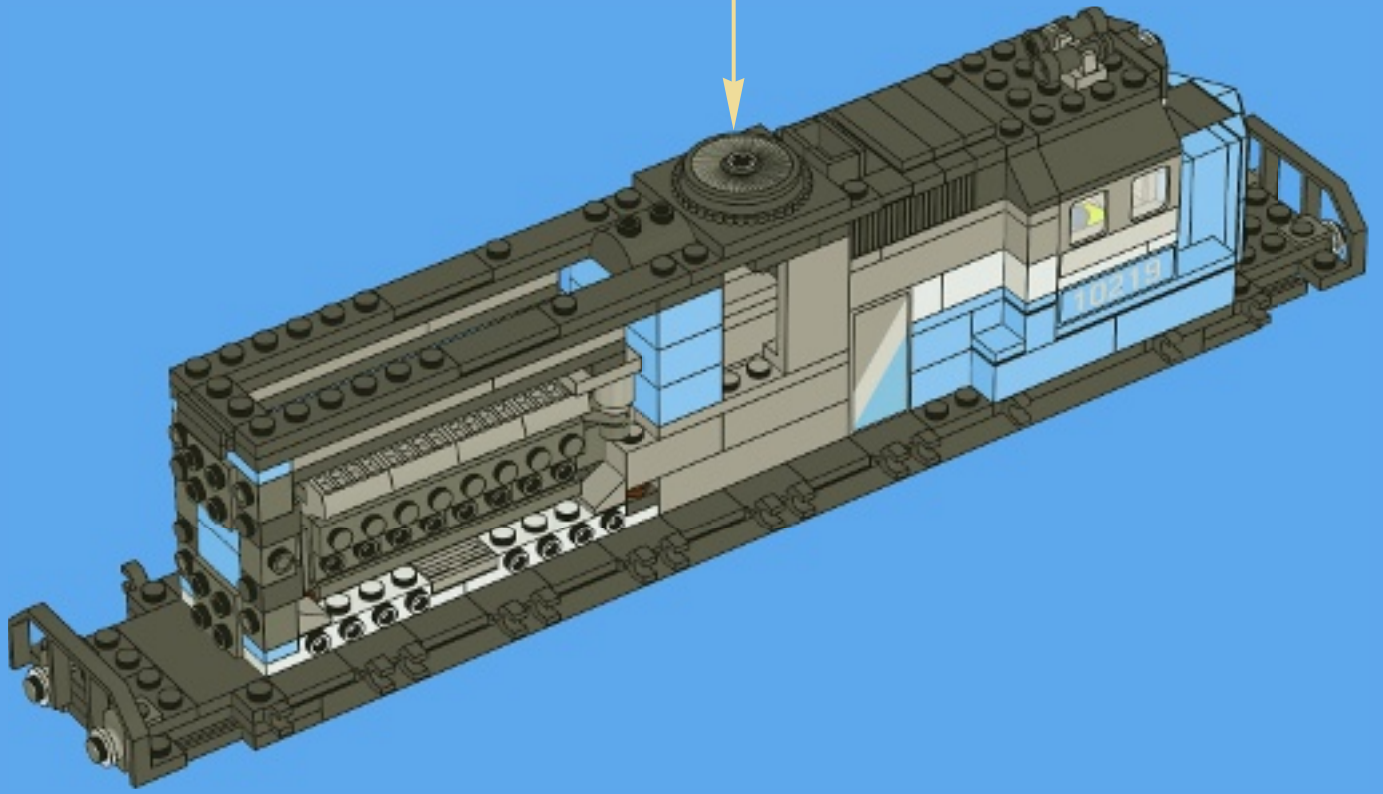
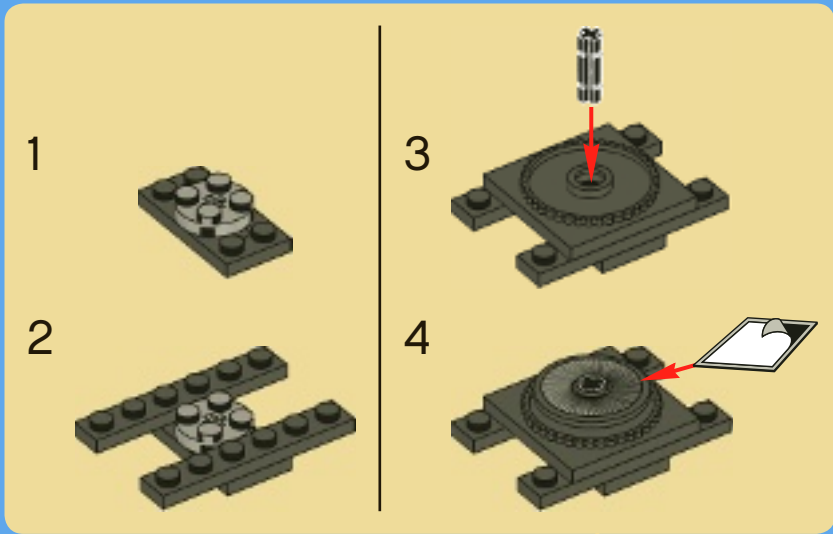

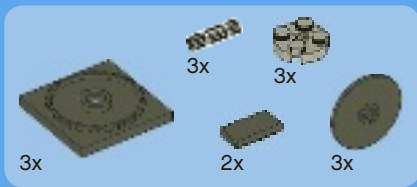

40

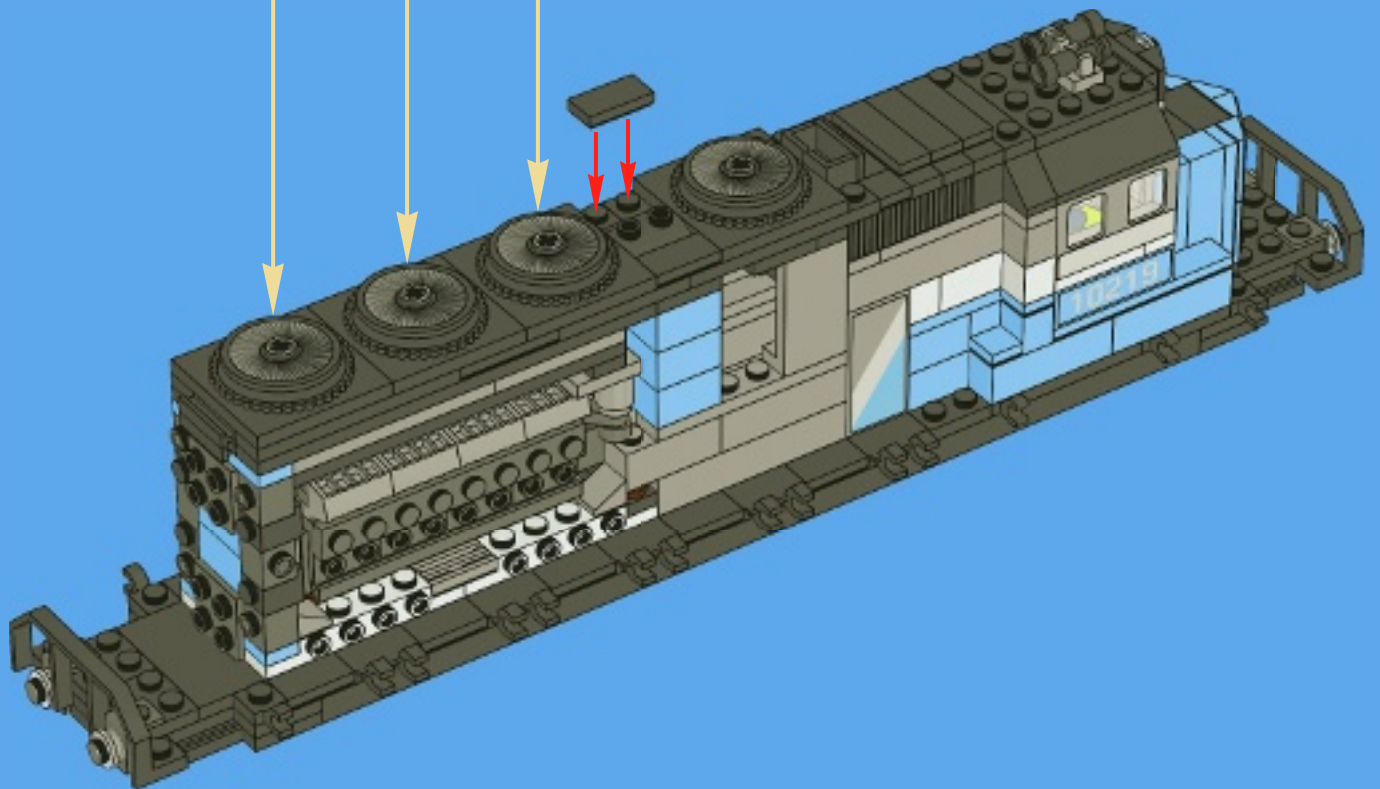
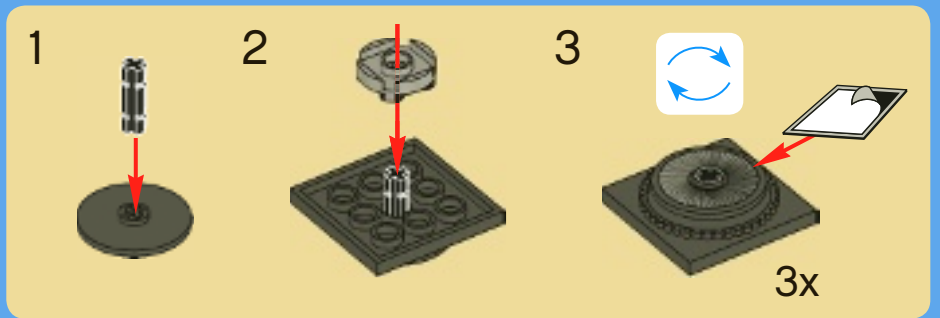

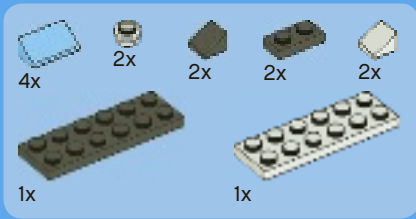

41

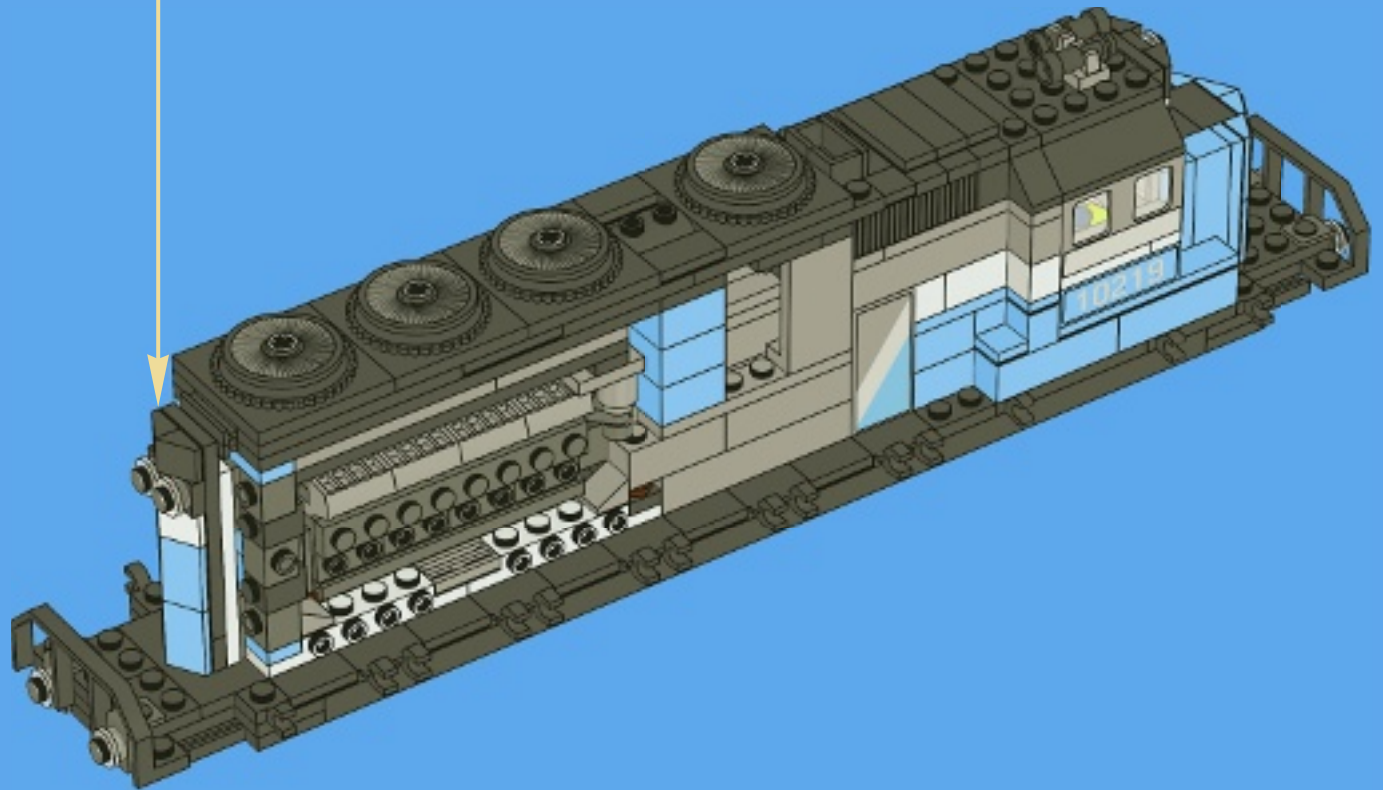
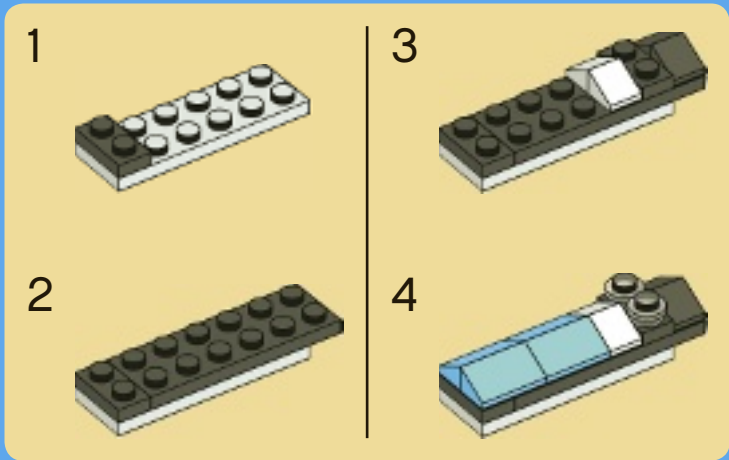



2x



4x

42

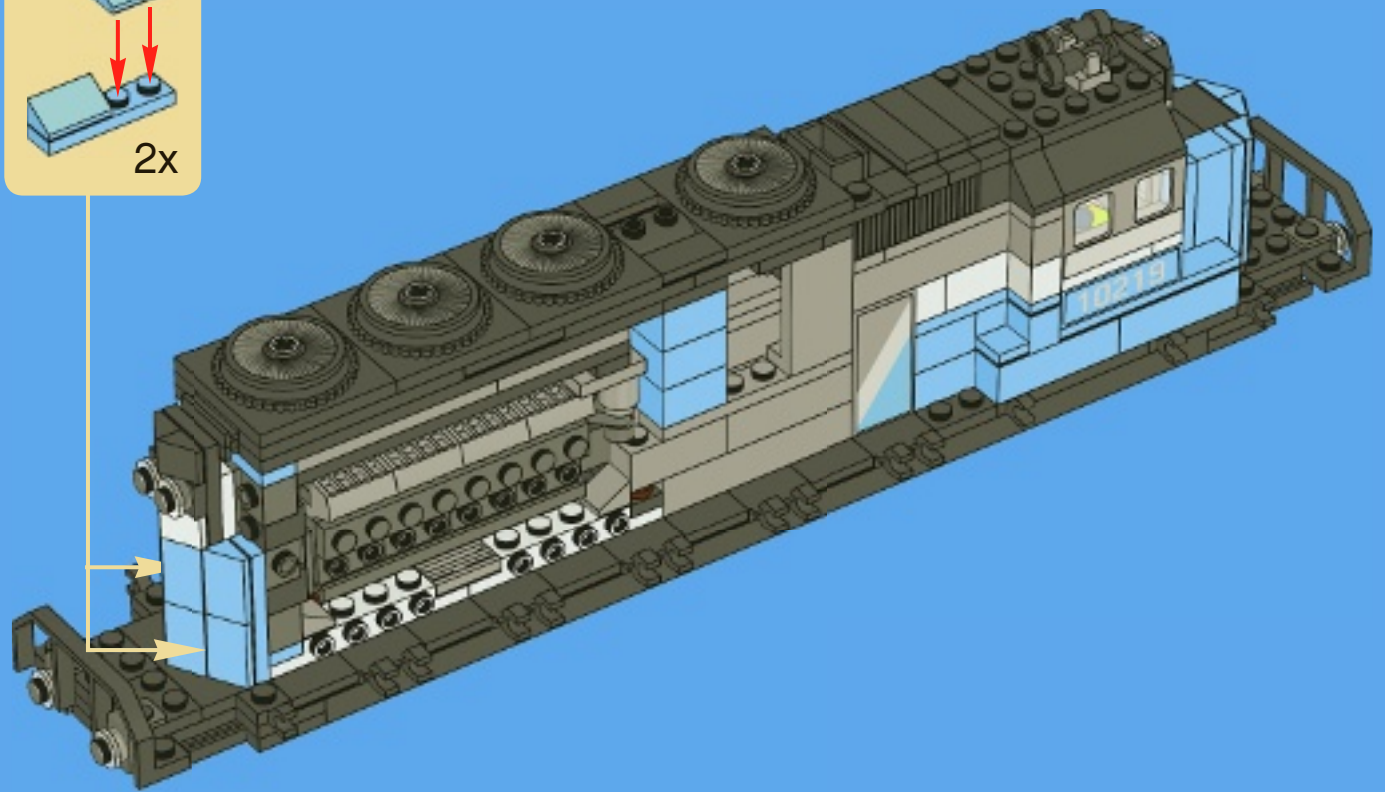
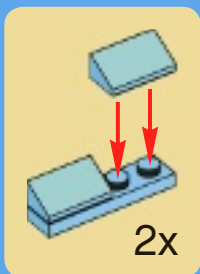



2x



2x



2x

43

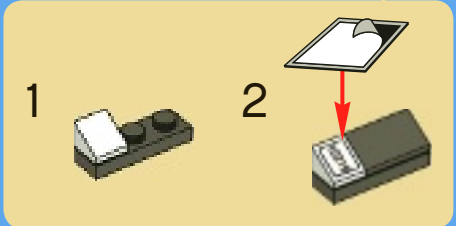
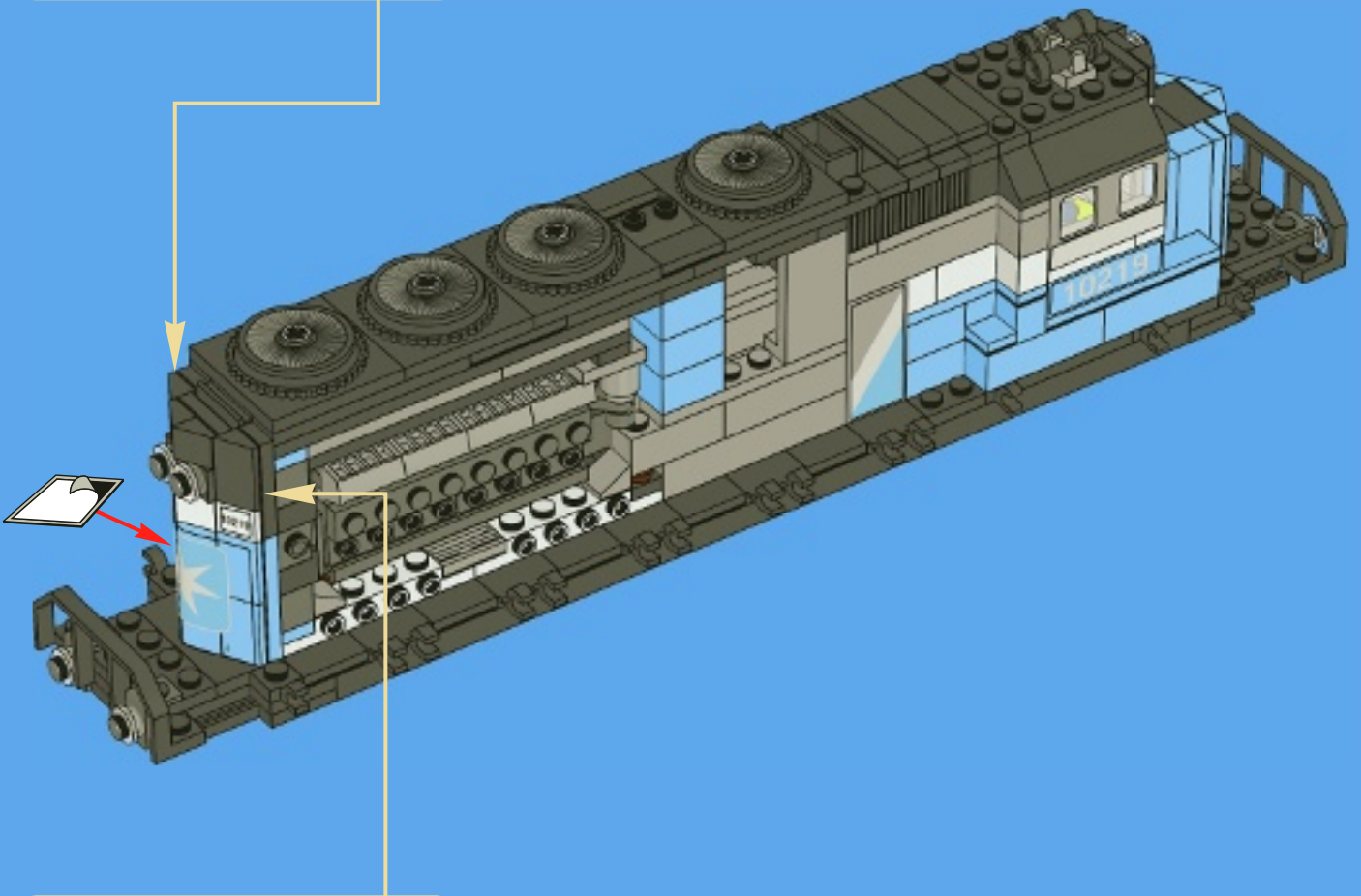
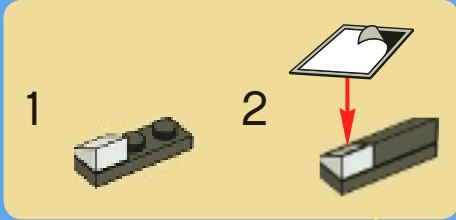

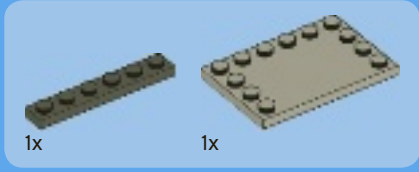
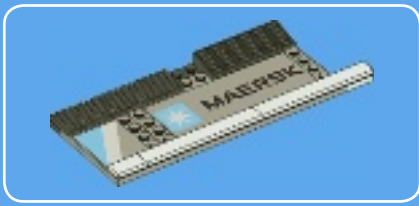

1

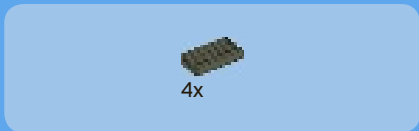

2

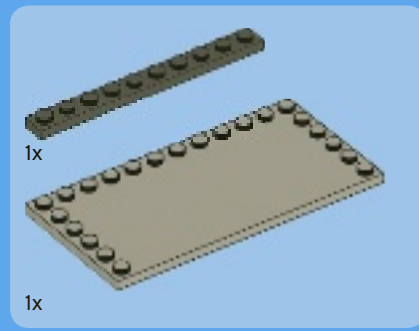

3

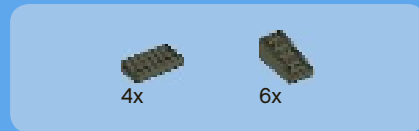
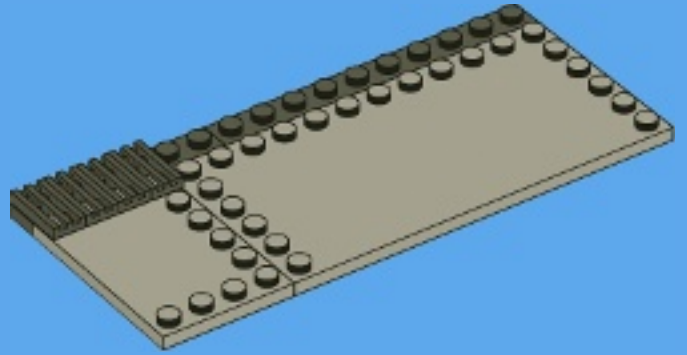

4

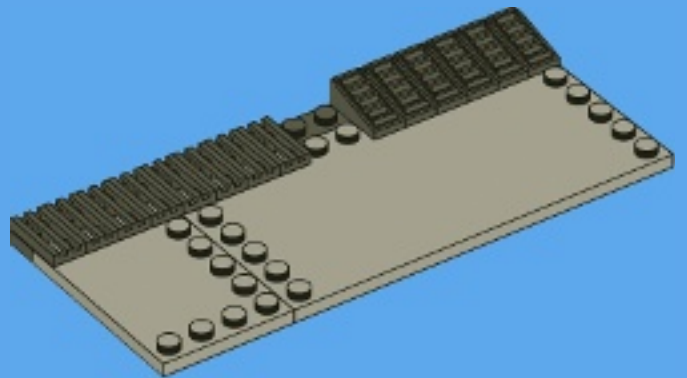

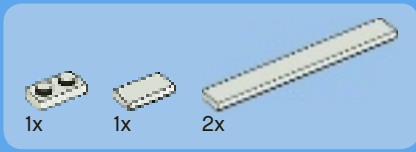

5

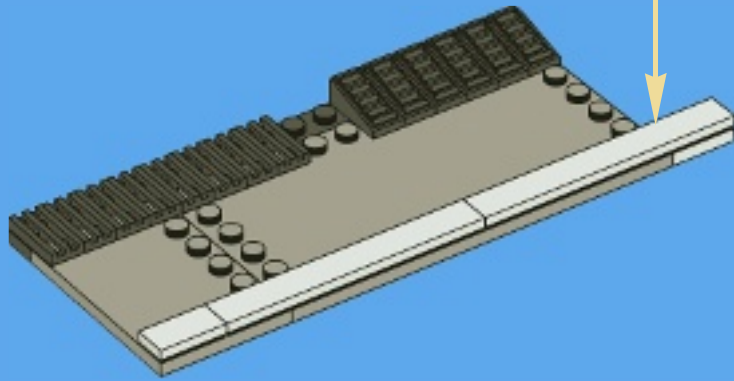
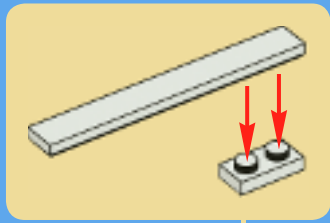

6

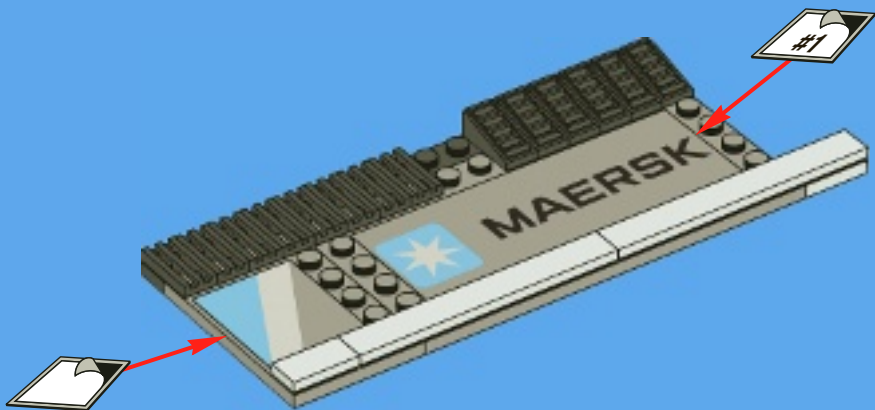

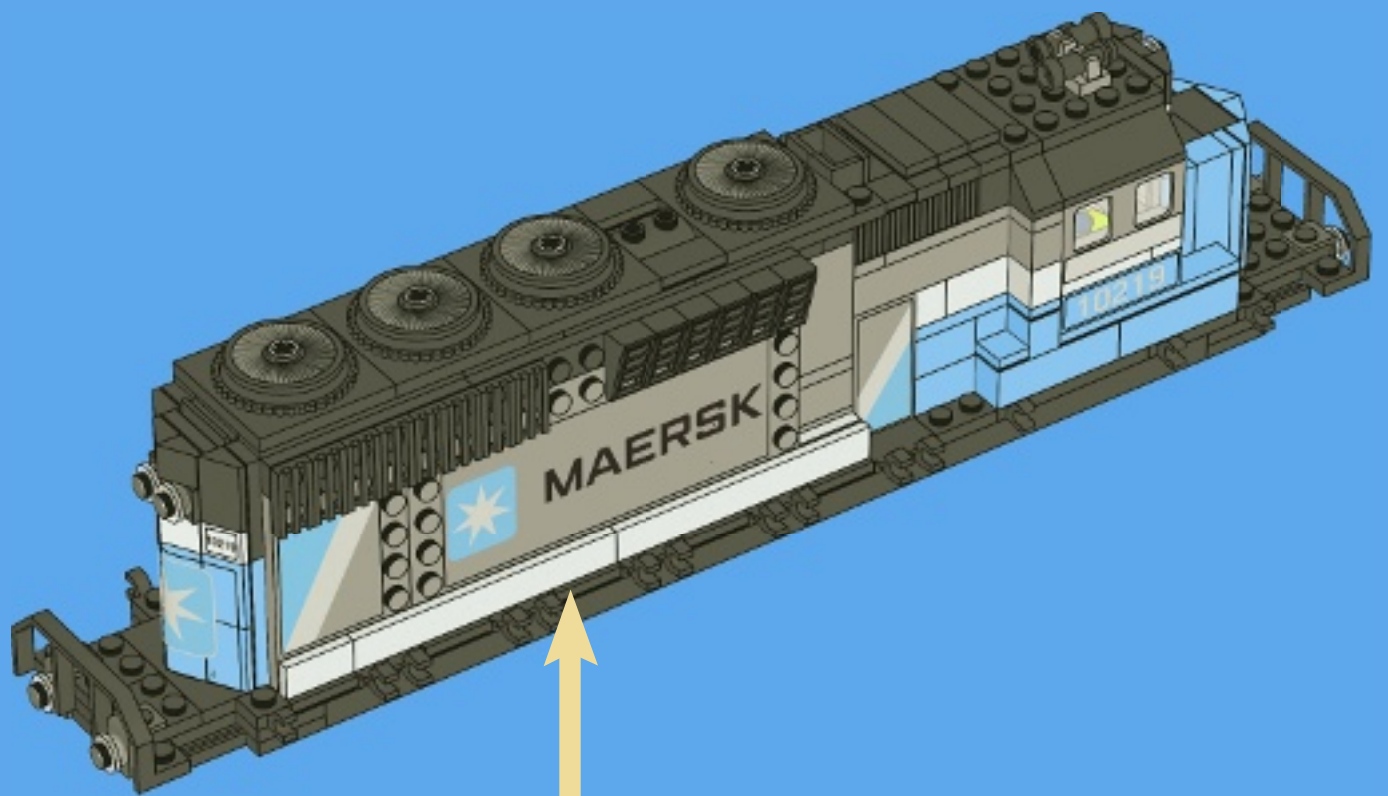



45

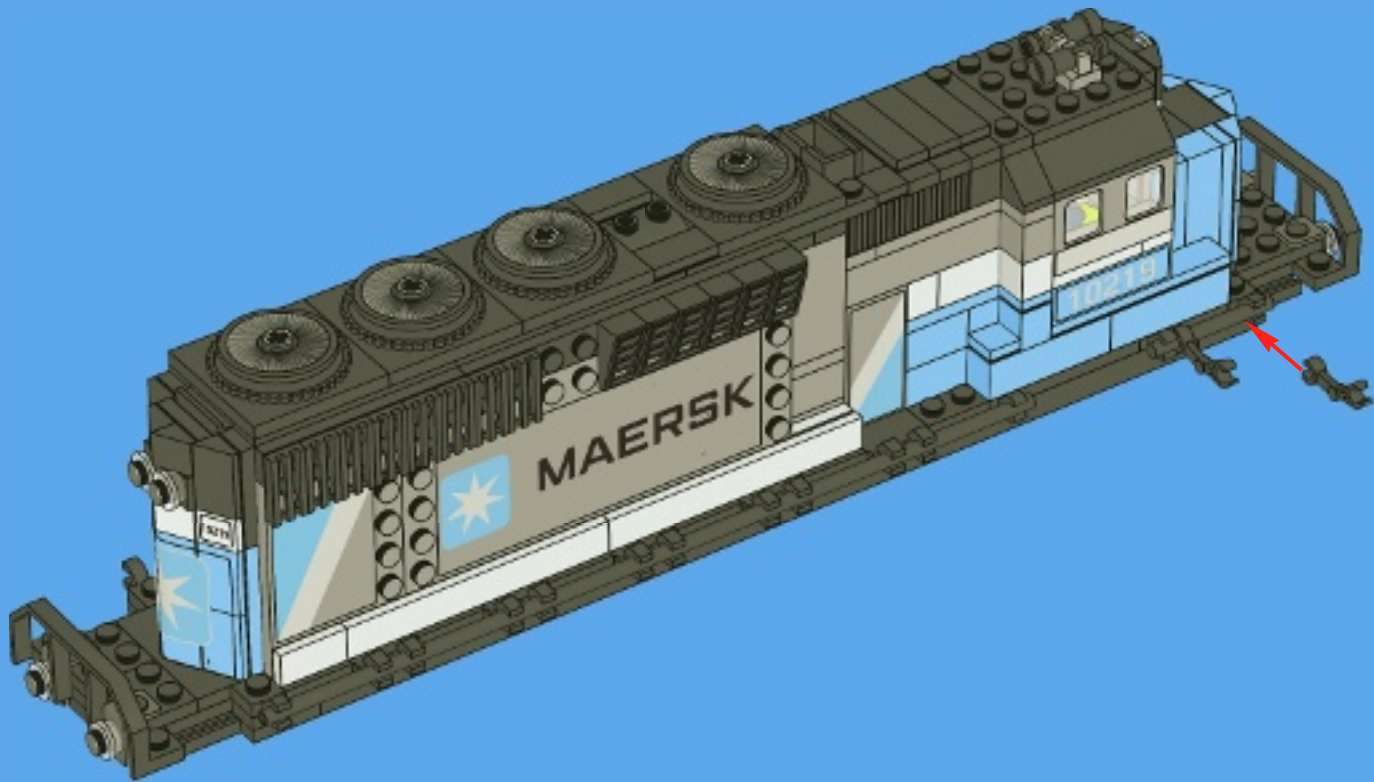



46

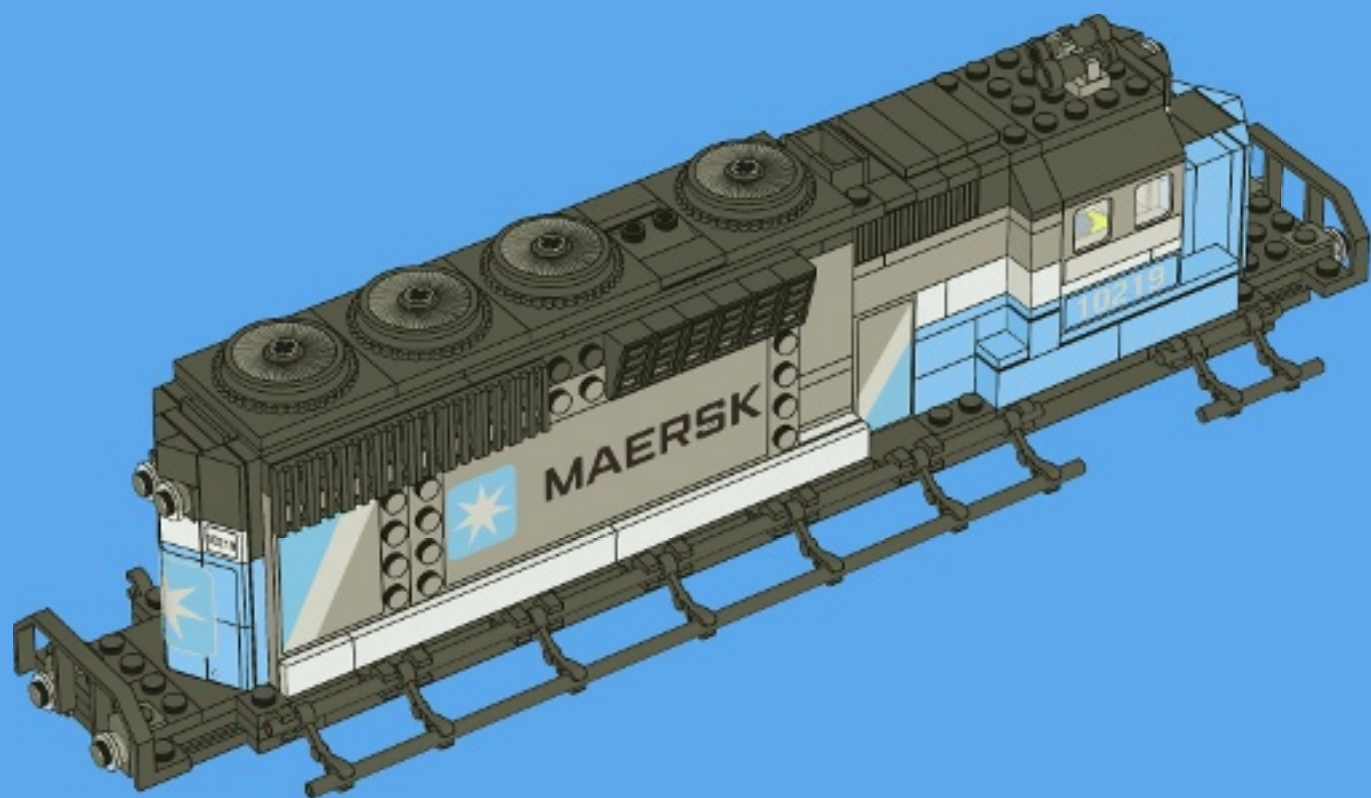

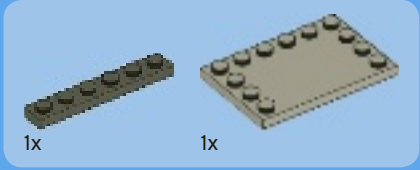
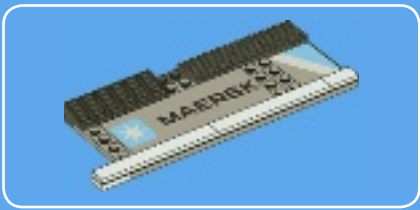

1

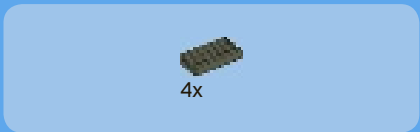

2

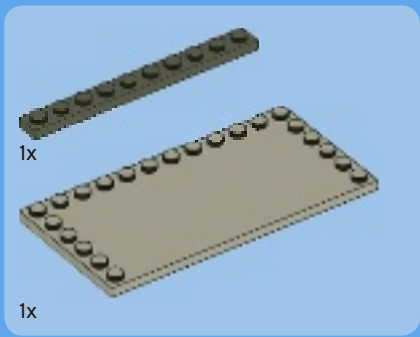
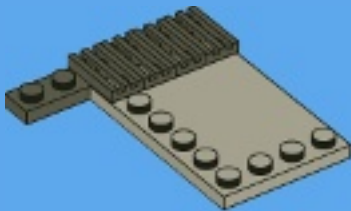

3

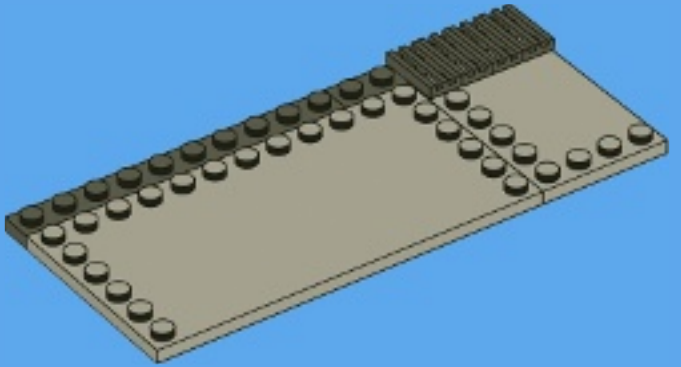

4

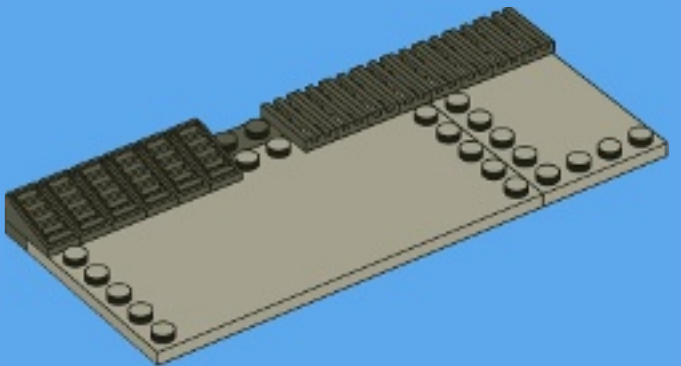

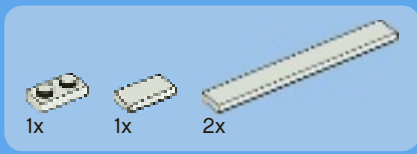

5

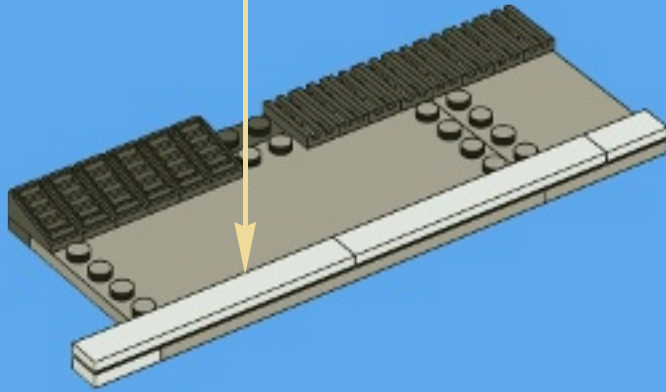
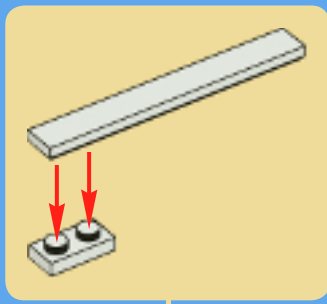

6

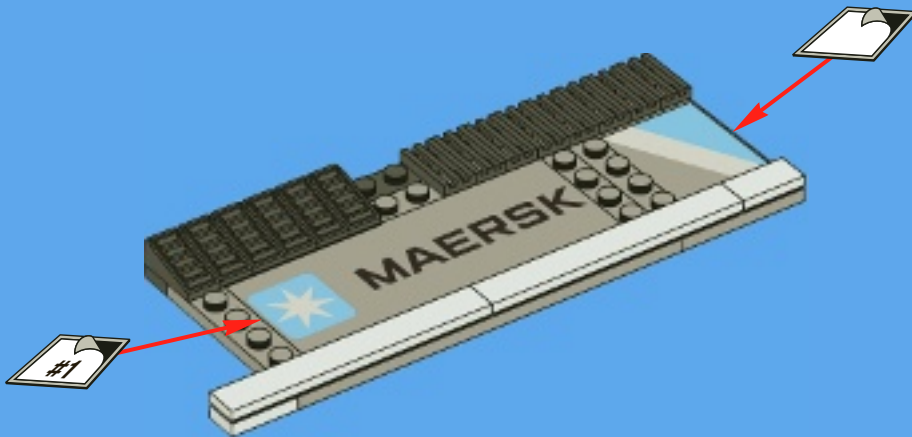

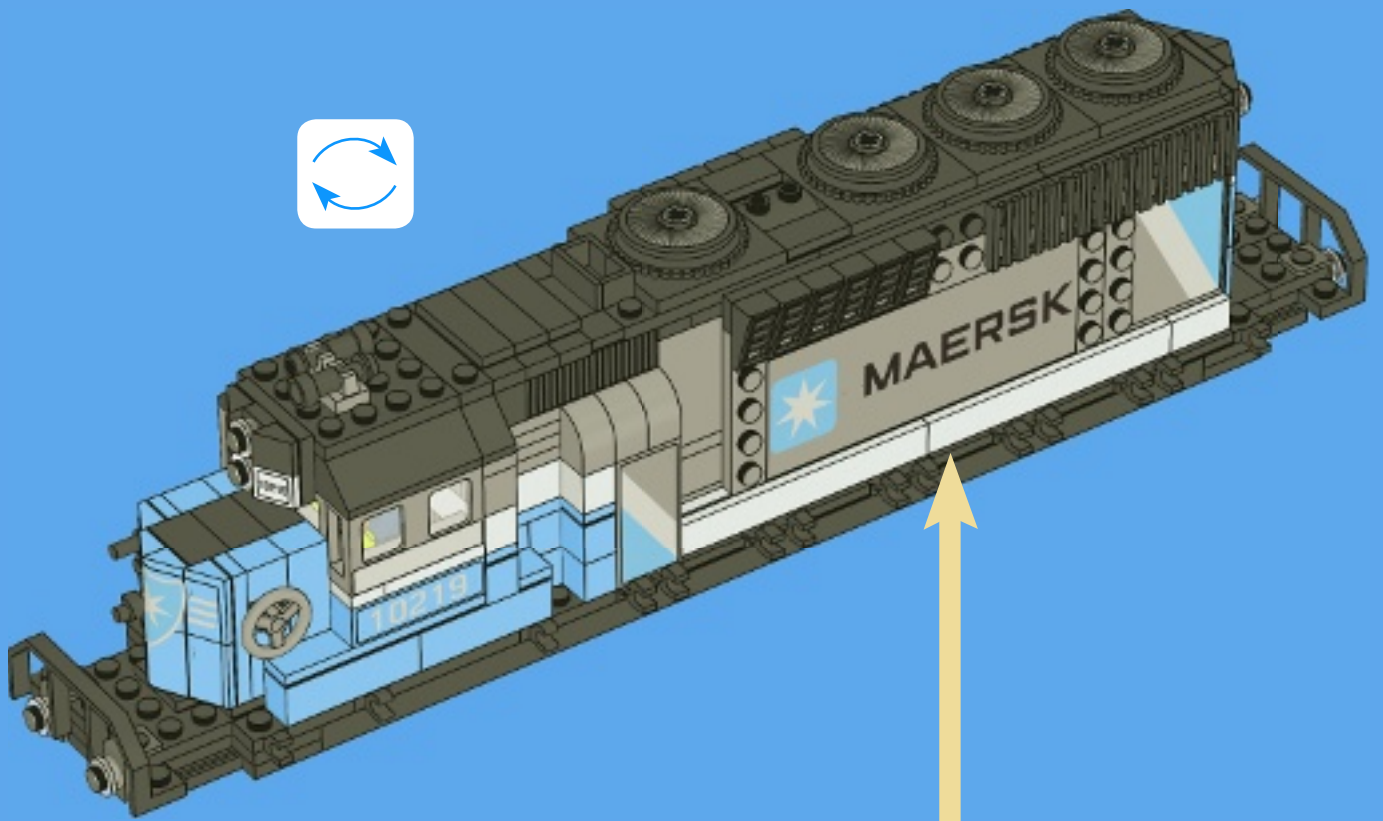



48

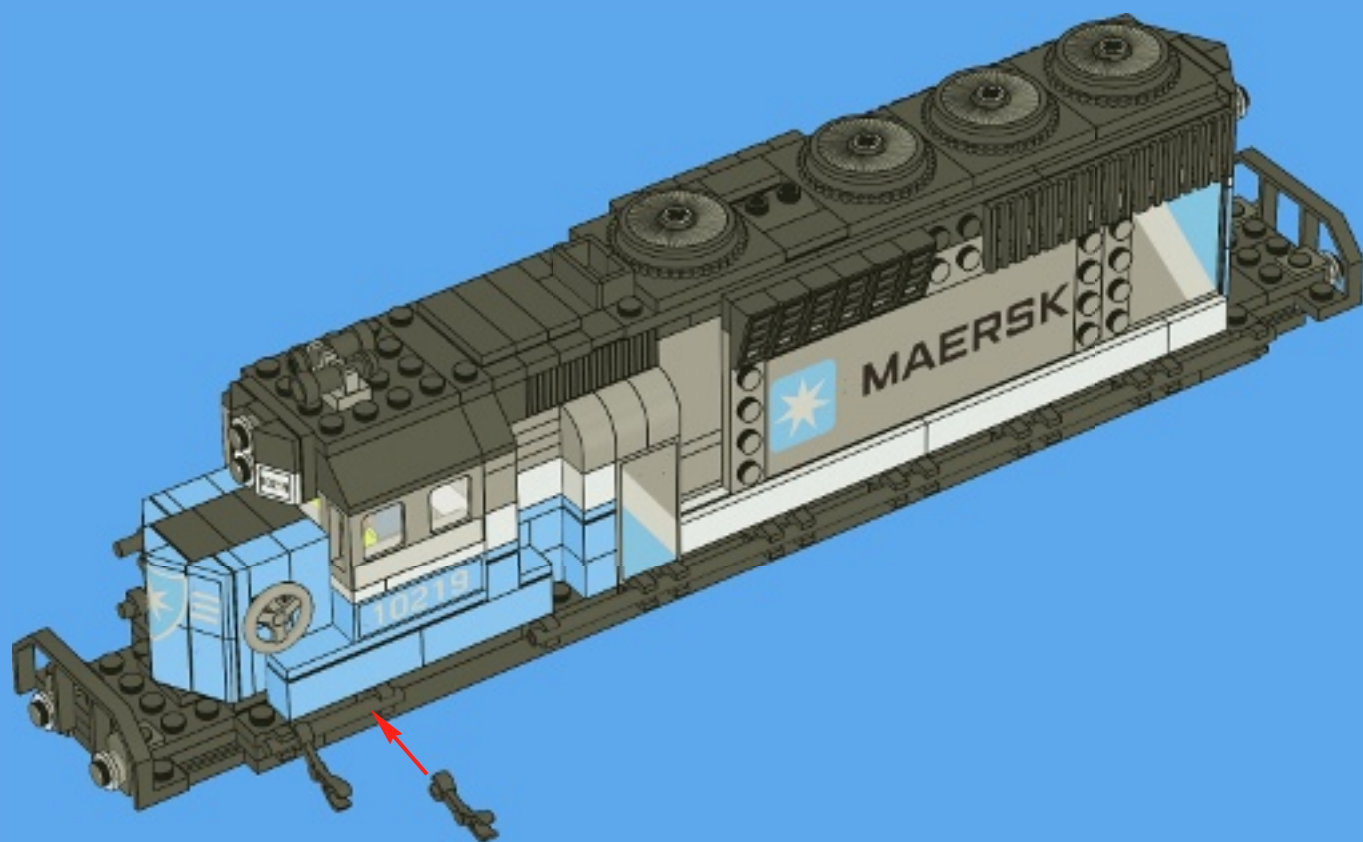



1x

7x

1x

49

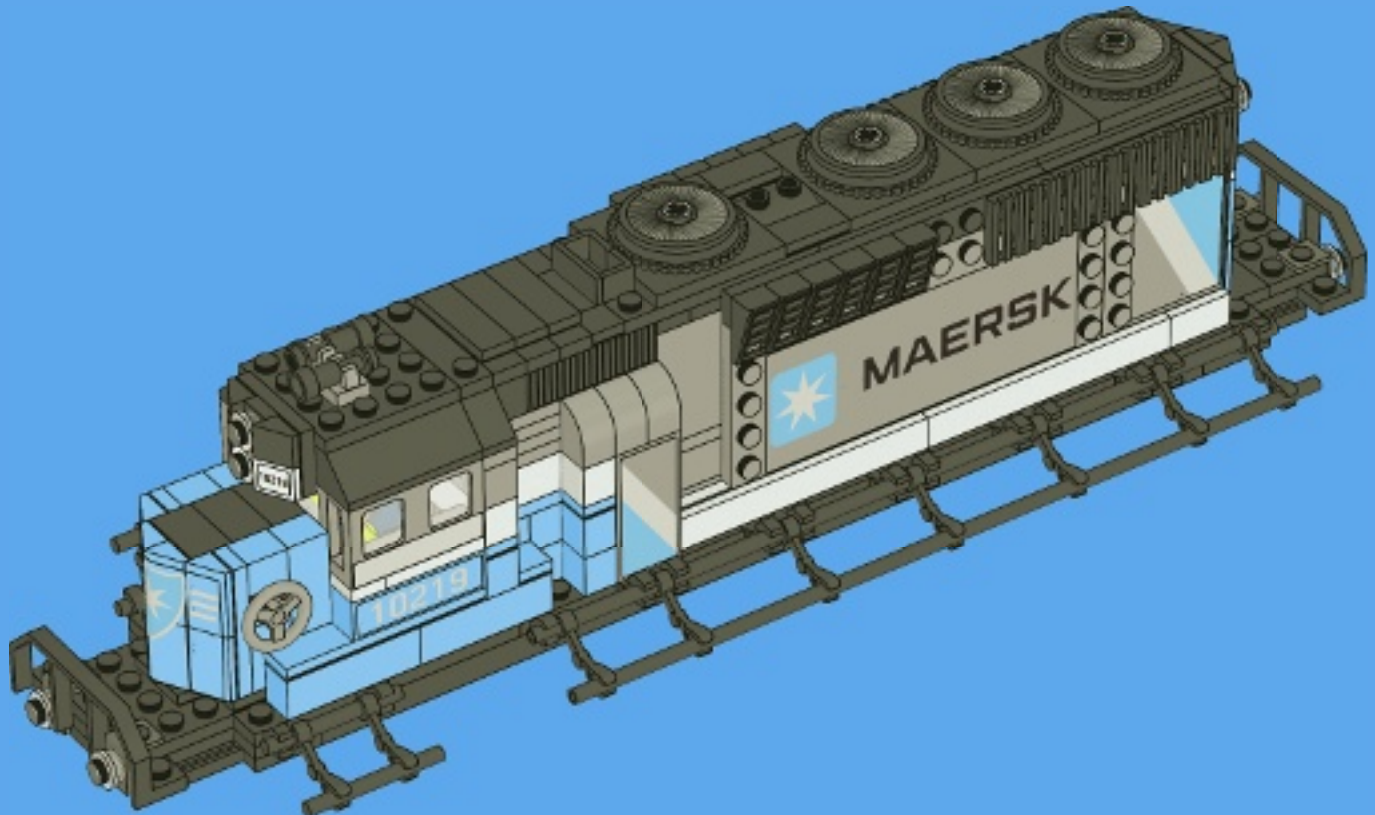

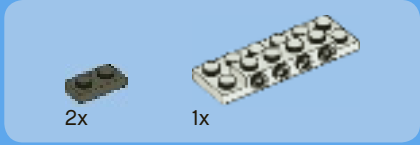

1

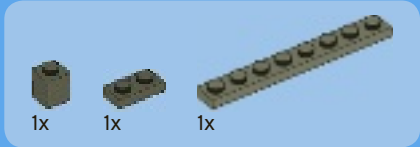

2

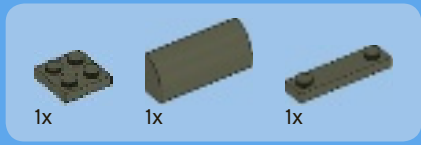

3

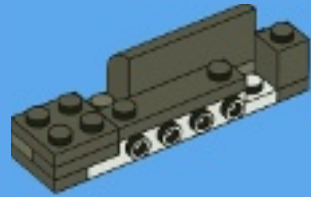

4

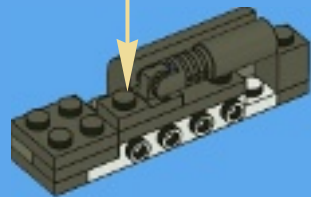
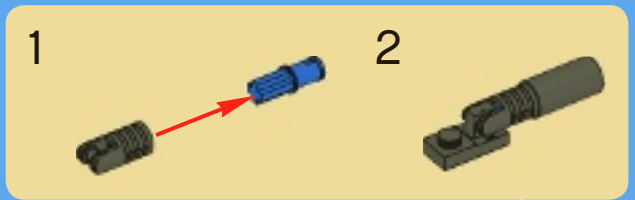



2x



1x

5

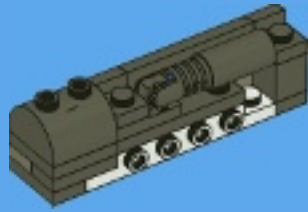

1x



1x



1x

6



2x



1x



4x

7

1

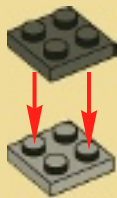

2

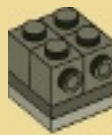

3

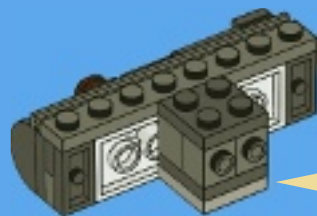

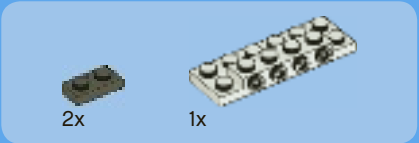

1

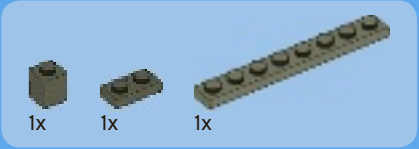

2

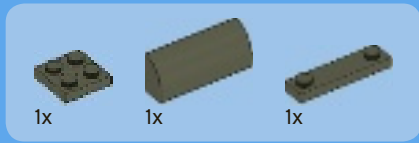
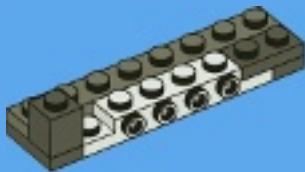

3

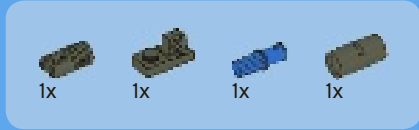
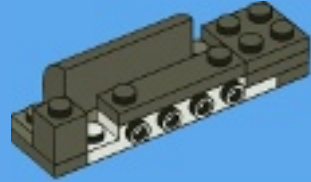

4





2x



1x

5

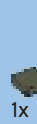
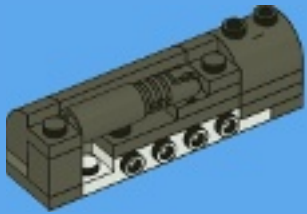

1x



1x



1x

6

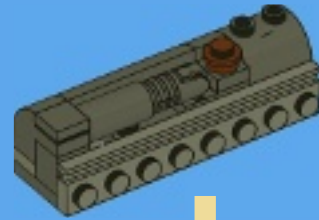

8





4x



1x

9



50

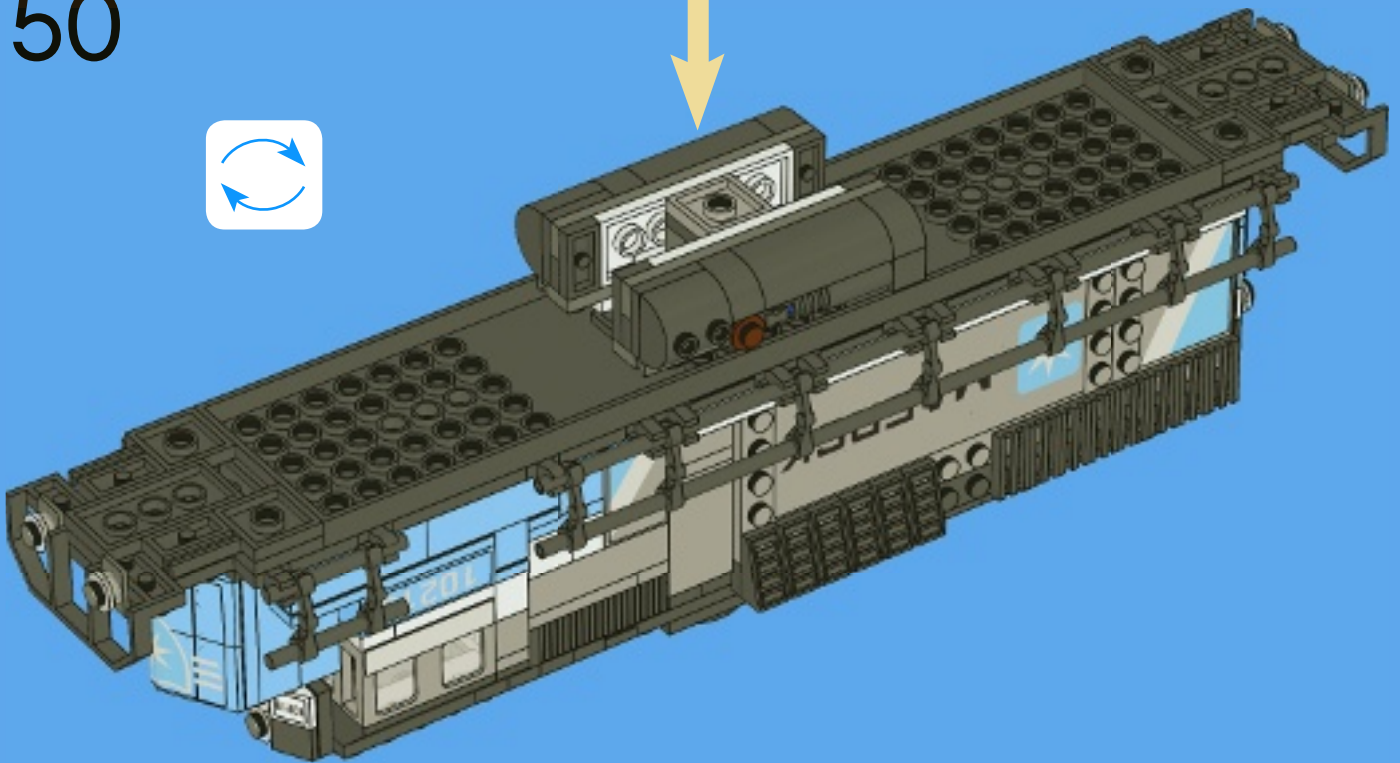

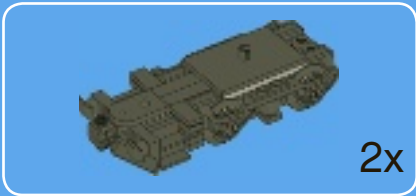

1

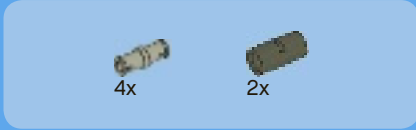
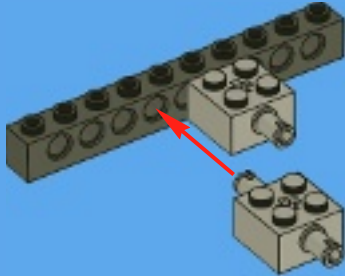

2

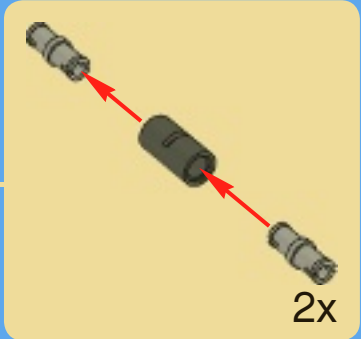
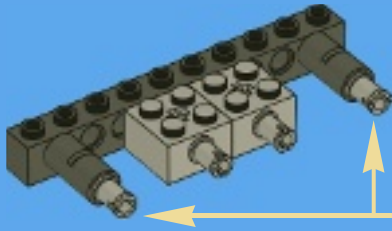

3



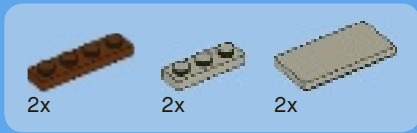

4

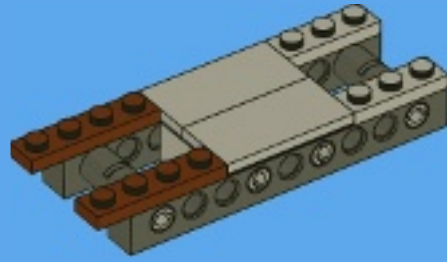

5



6

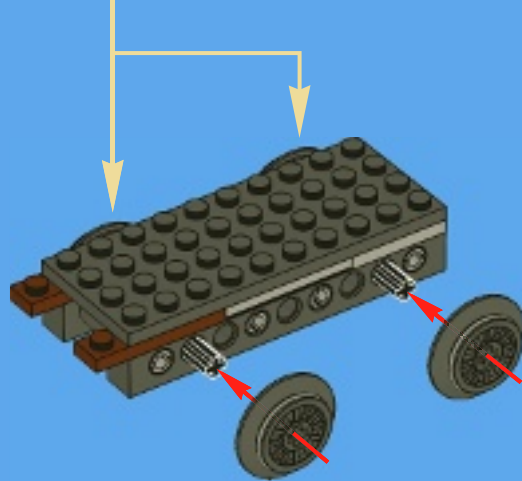
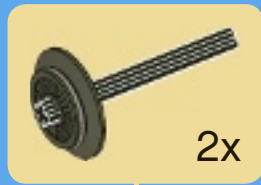



7

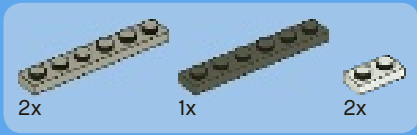

8



9



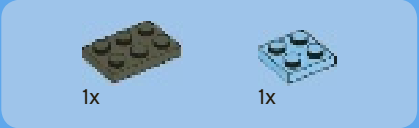

1

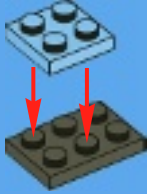

2



3

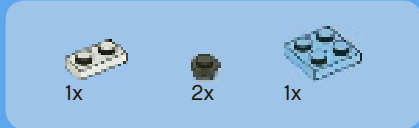

4



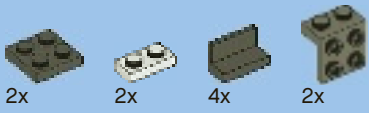

5

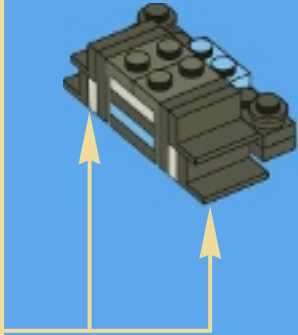
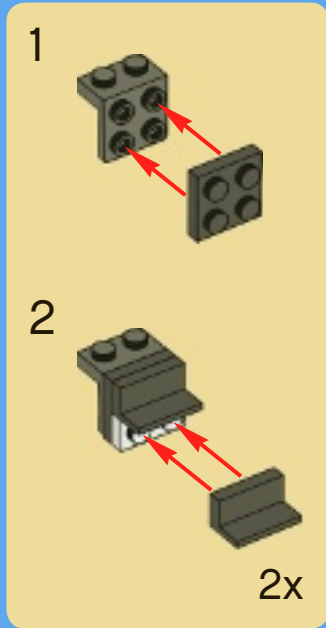

1x

6



10

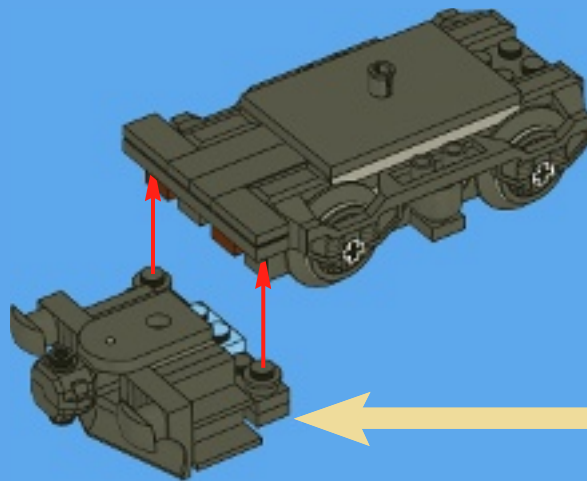

2x

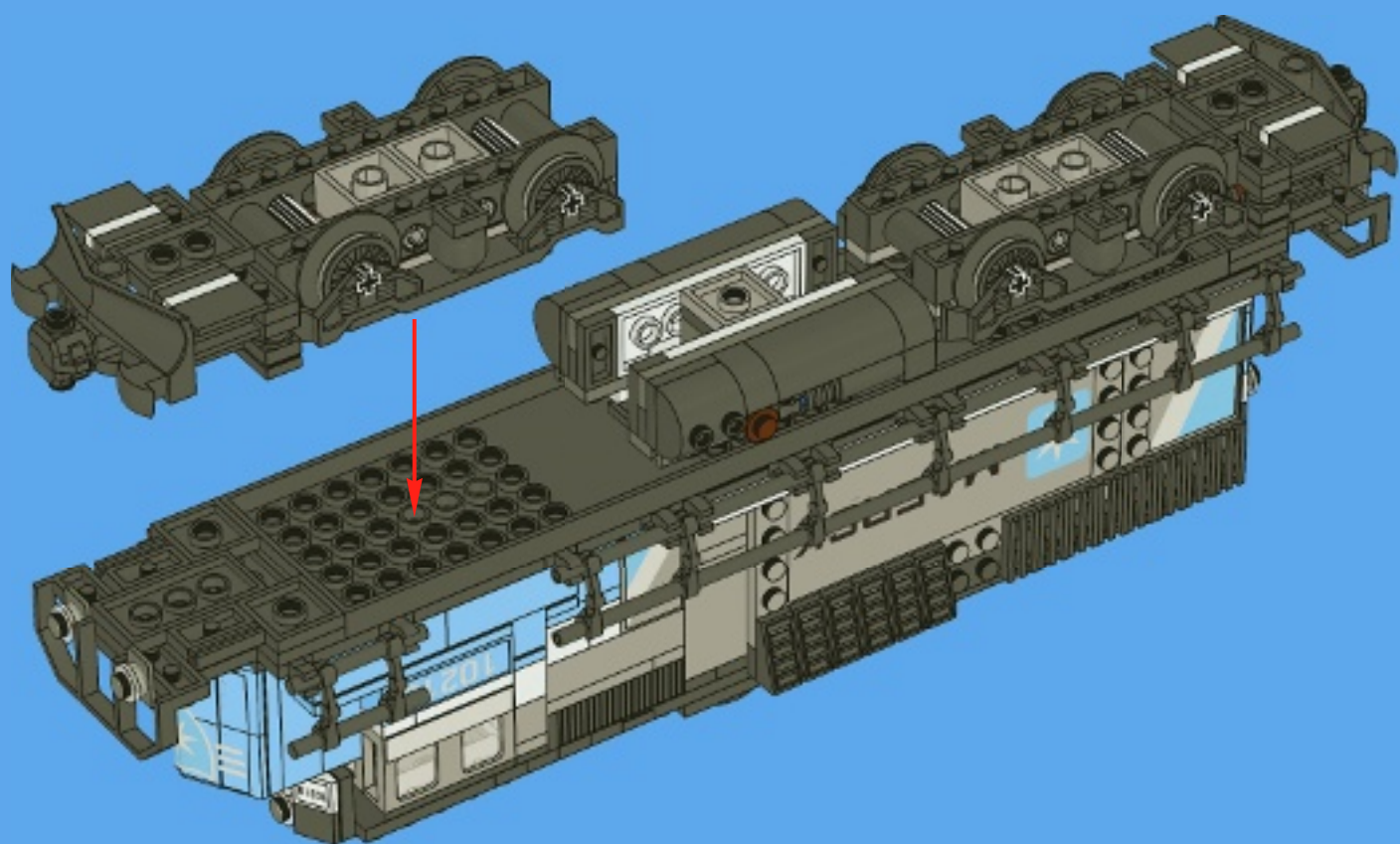

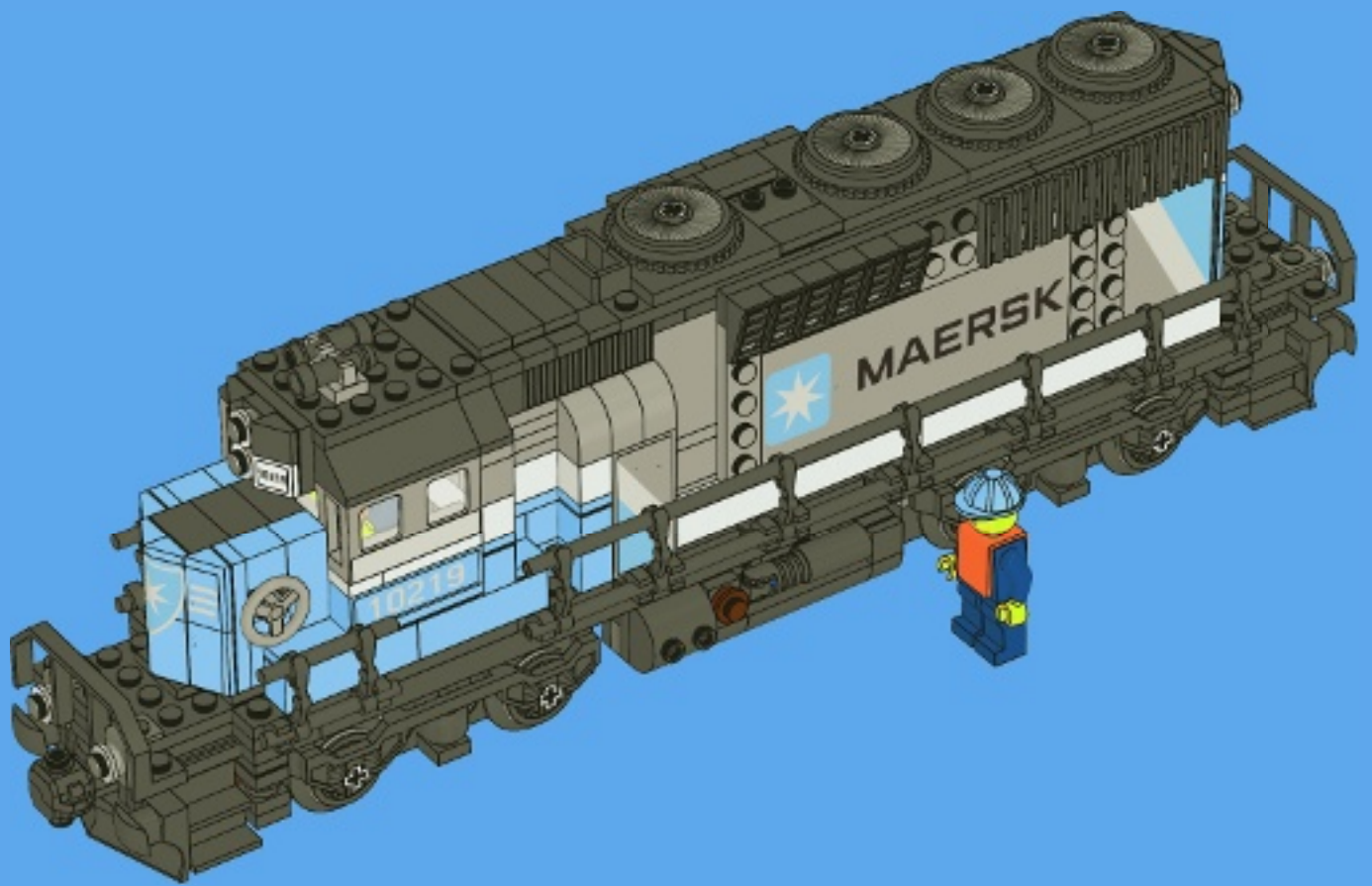

10211



10214



LEGO and the LEGO logo are trademarks of the LEGO Group. ©2011 The LEGO Group.
©2011 Lucasfilm Ltd. & TM. All rights reserved. 4654998



10219





2

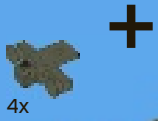

4x

+

2x

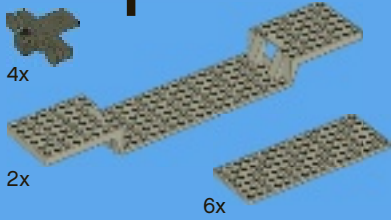

6x



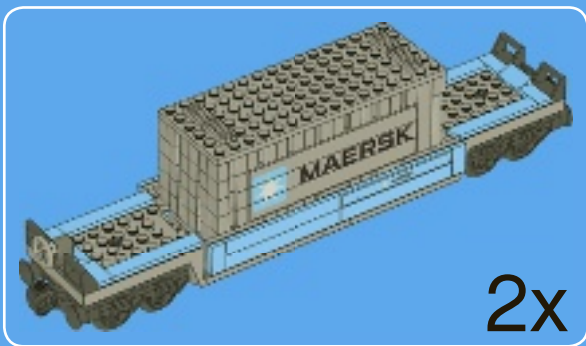

2x

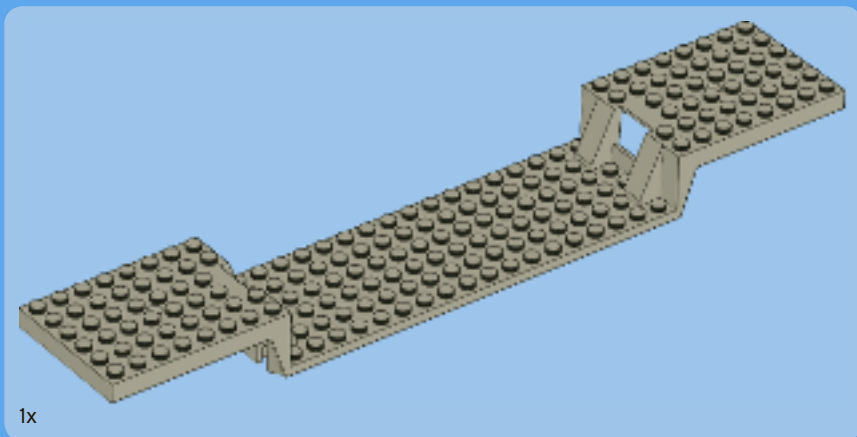

1x

1

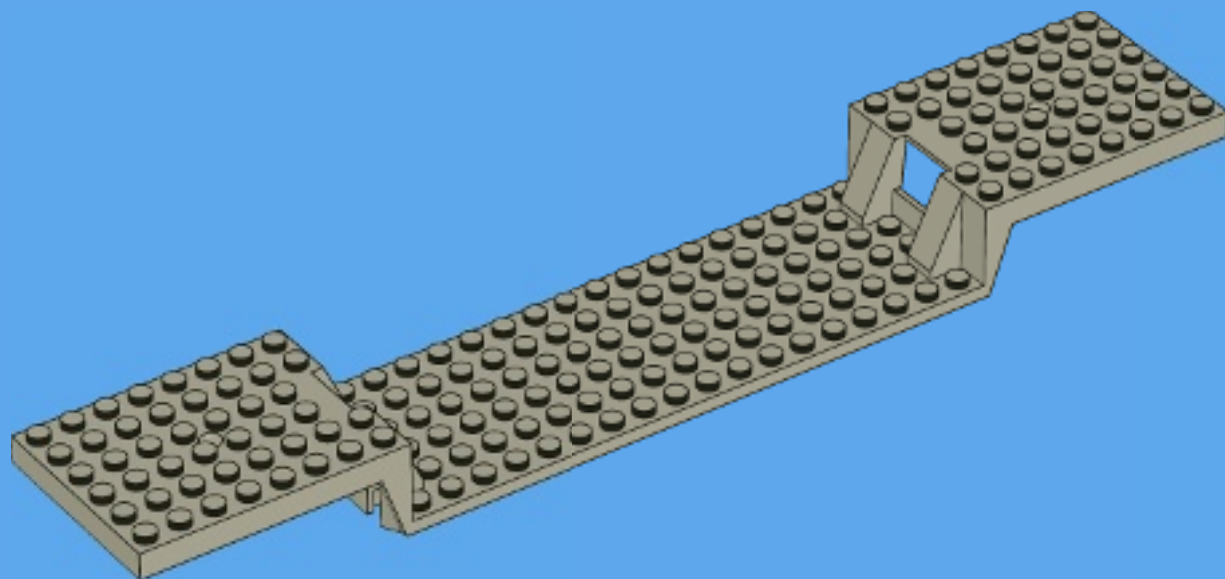



4x



2x

2

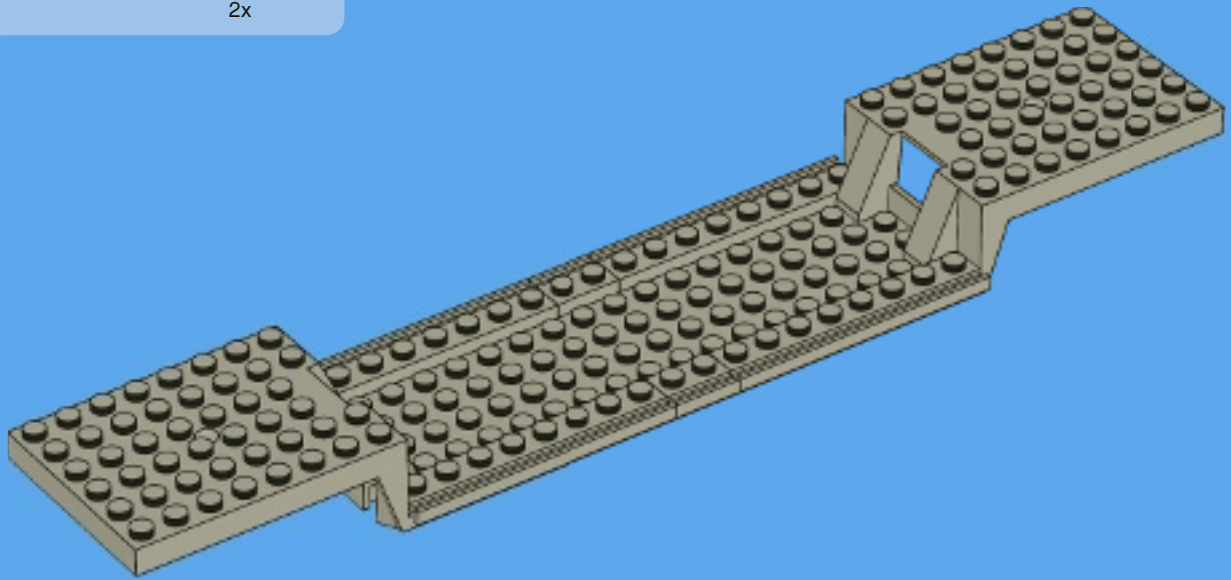

3x

3

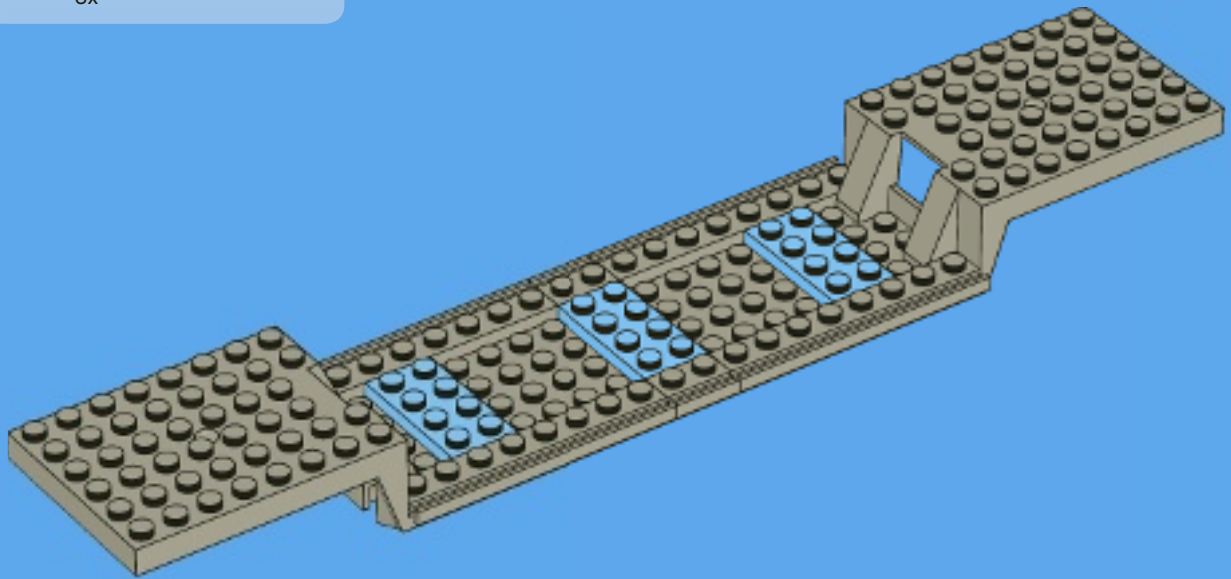



4x



4x



4x



4x

4

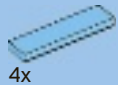
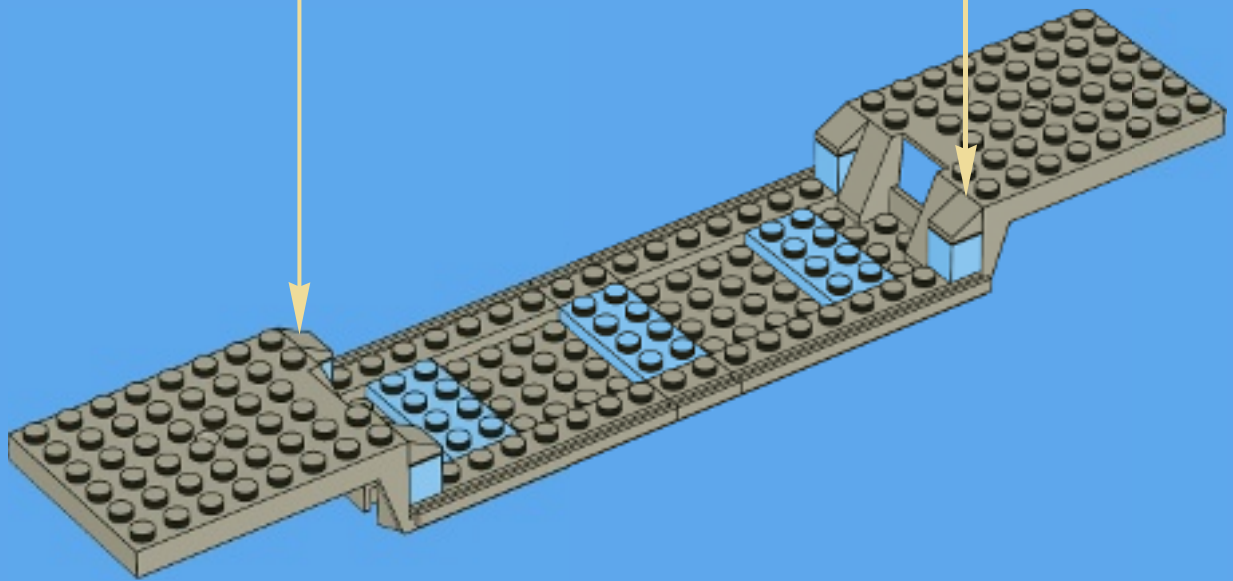

4x



4x

5

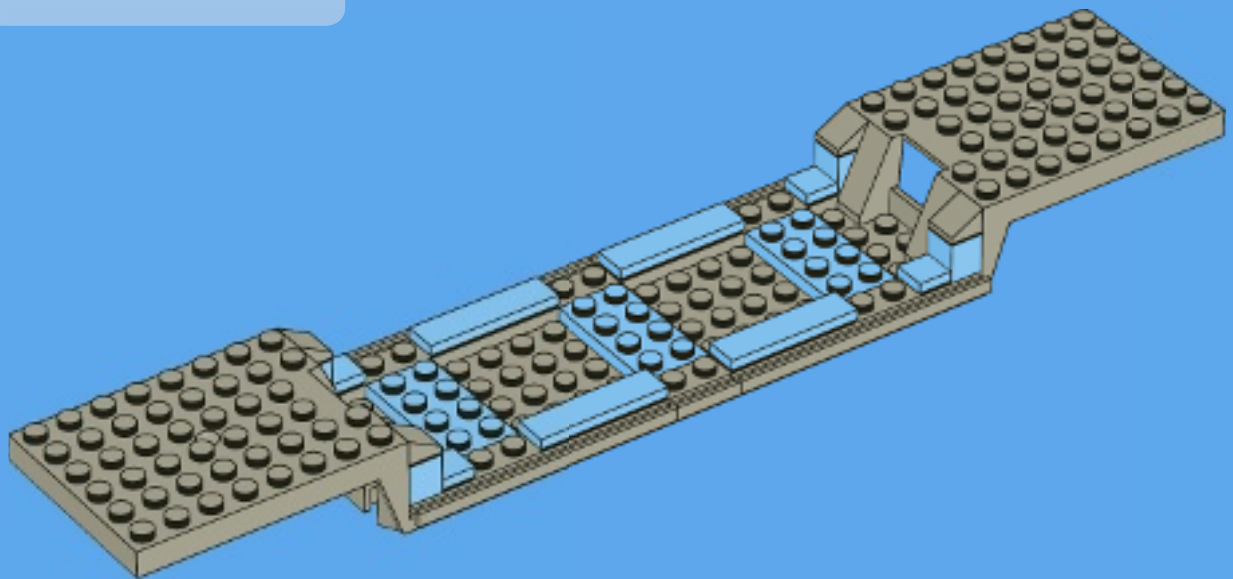



6x

6

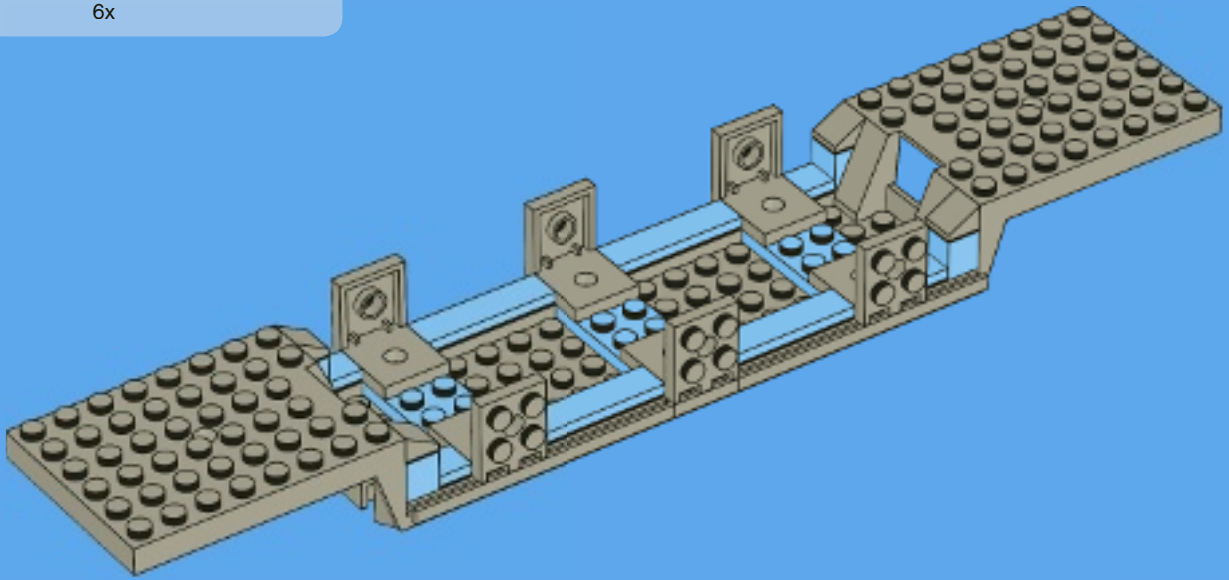

4x



4x



8x



1:1

7

1

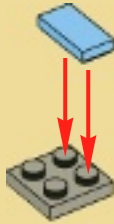

2

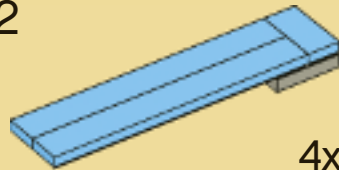

4x

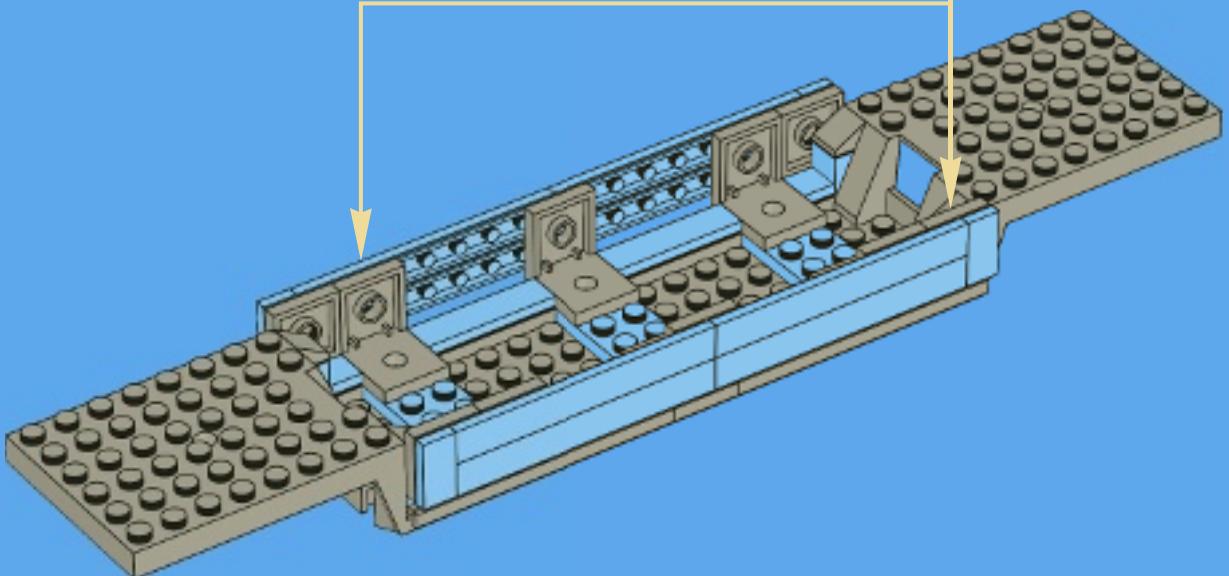

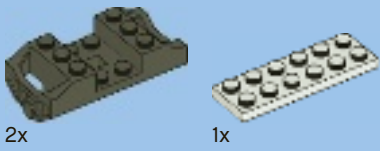

1

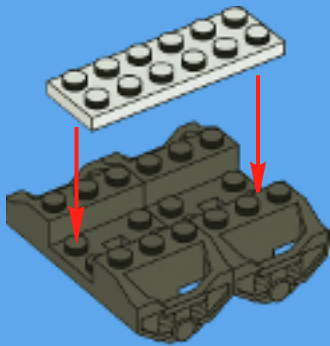

2



3

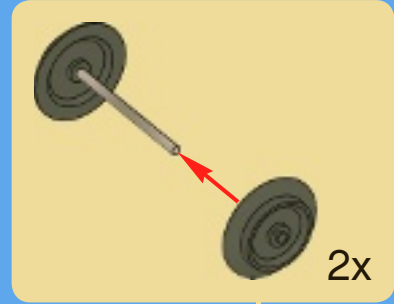

4



2x

8

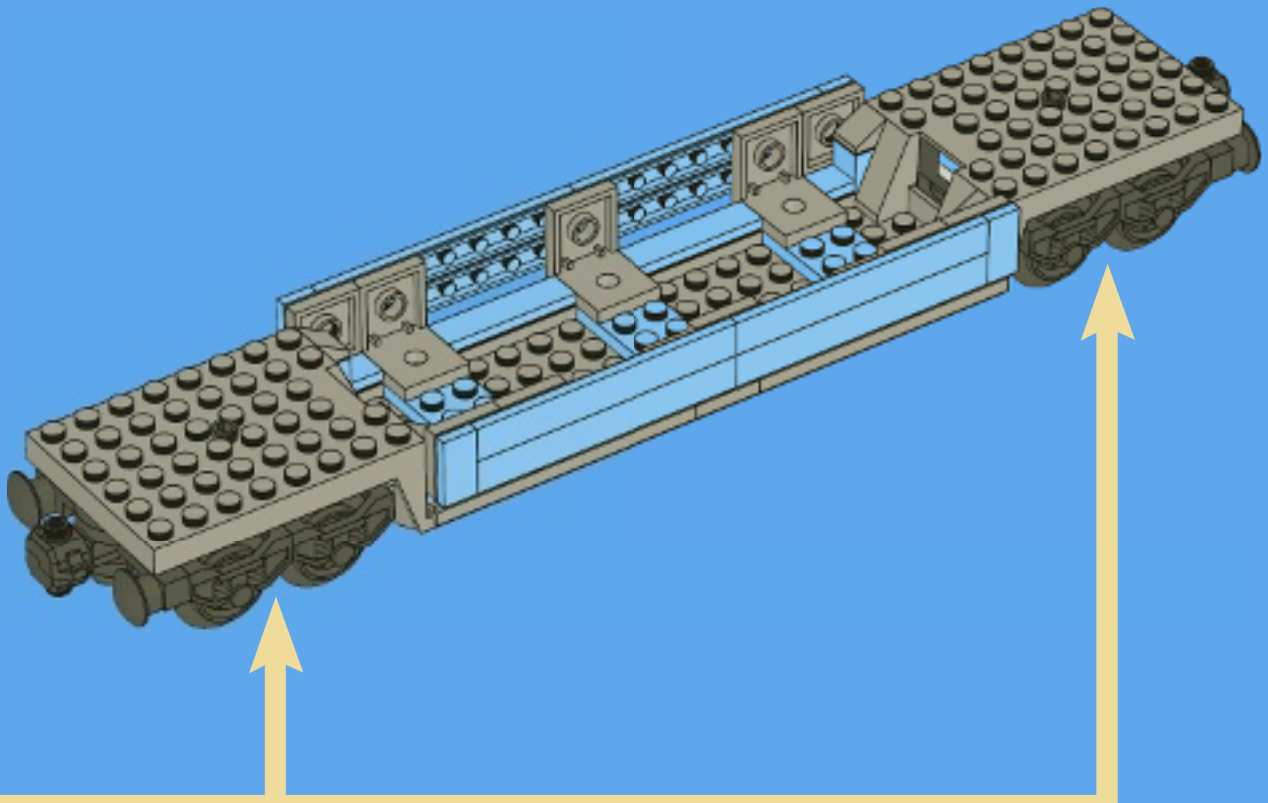

1x



2x

9

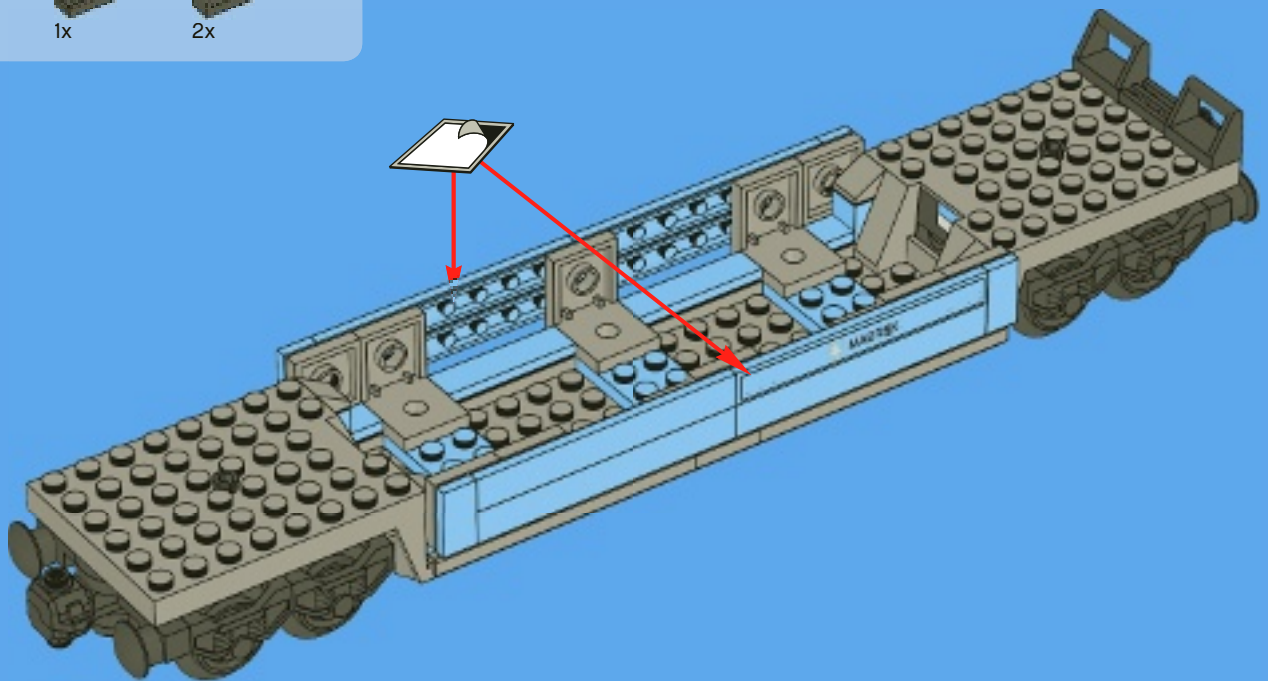



10

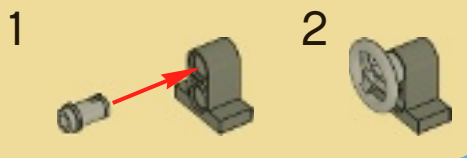
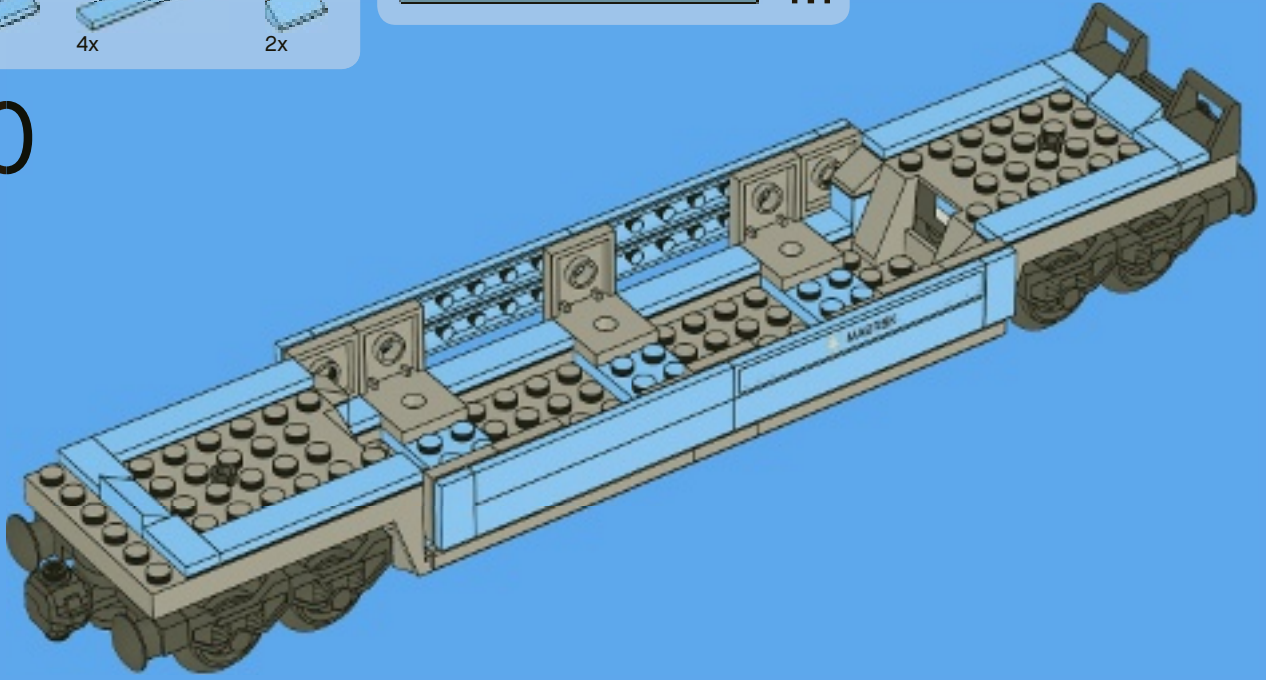

11

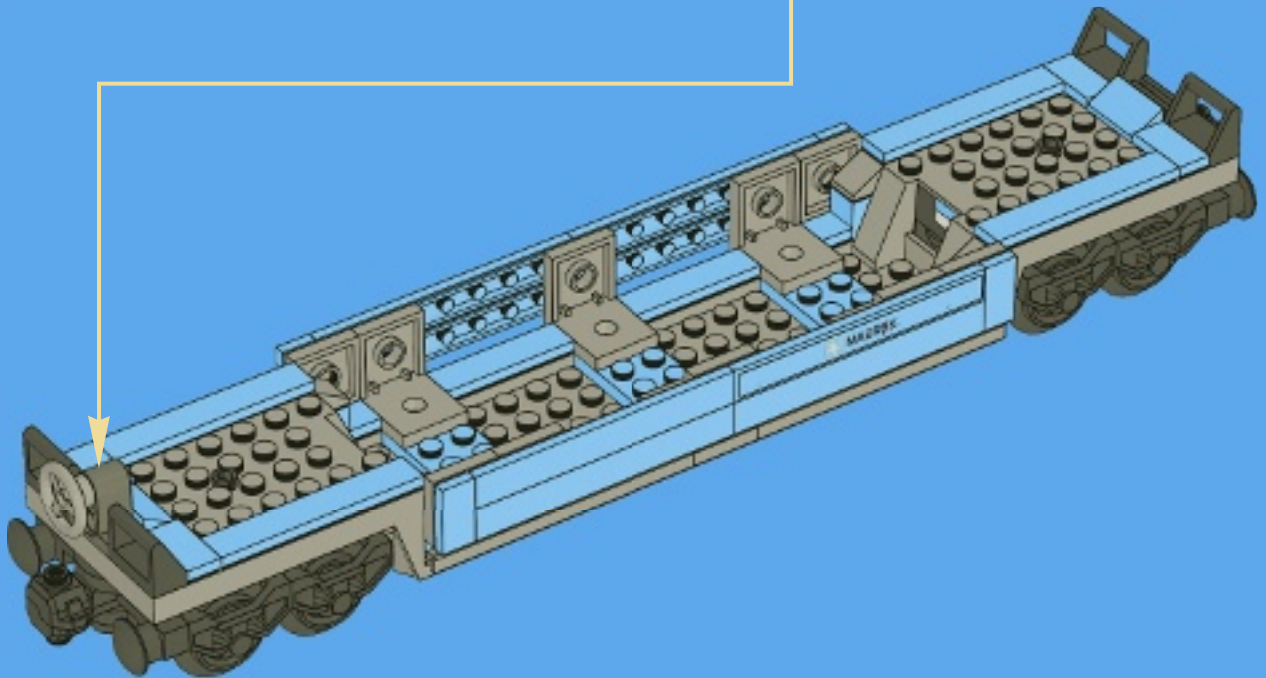

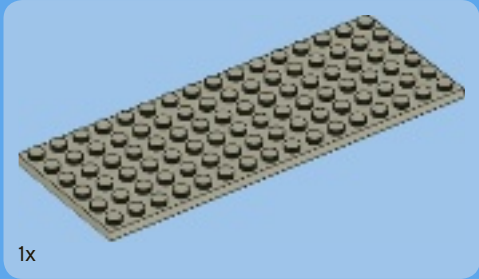

1x

1

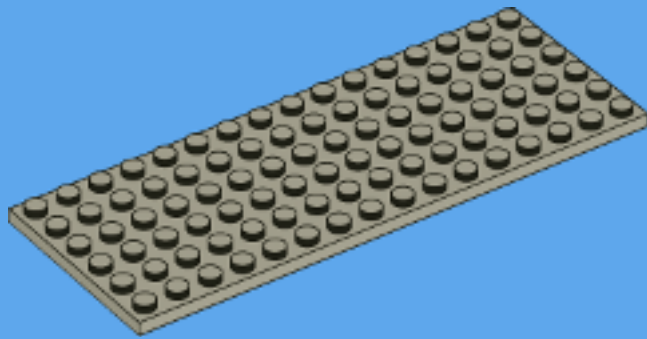

16x

2

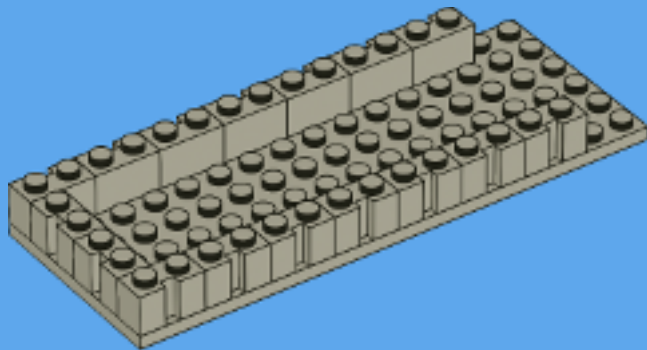

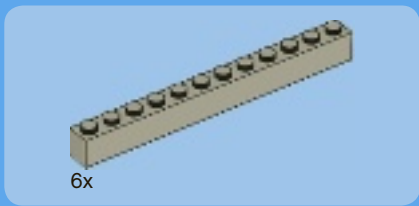

3

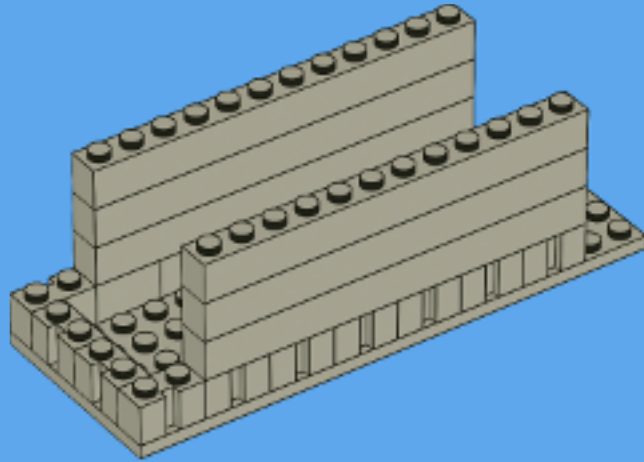

4

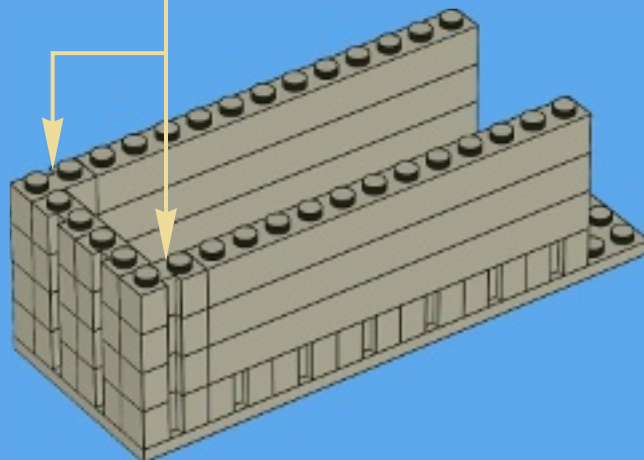
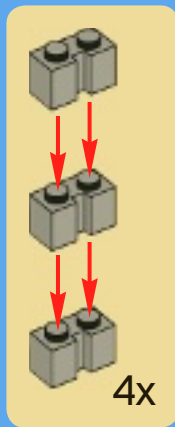

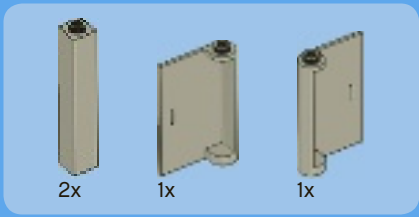

5

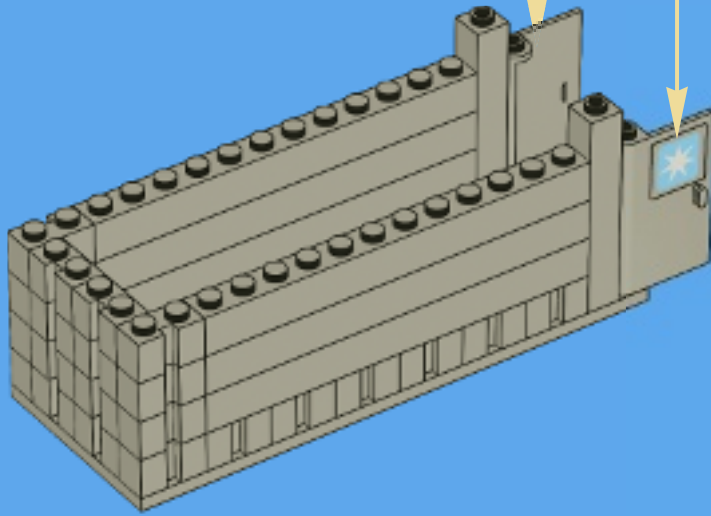
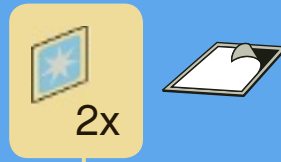

6

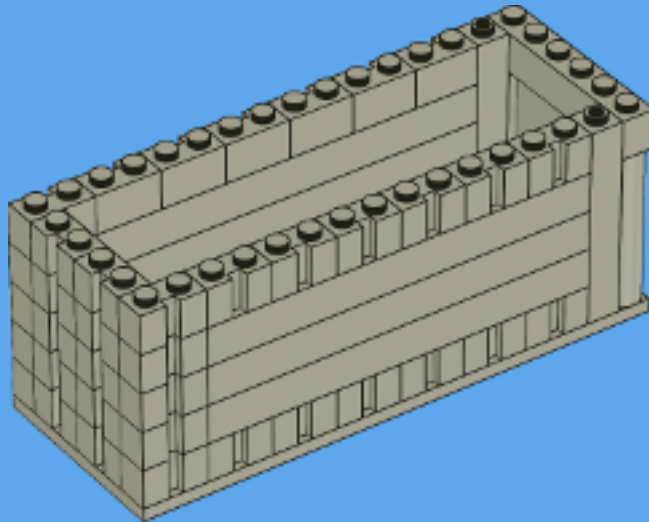

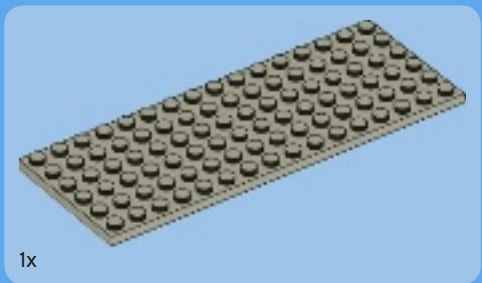

1x

7

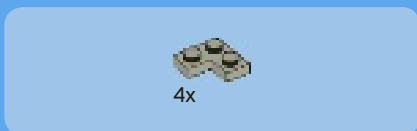
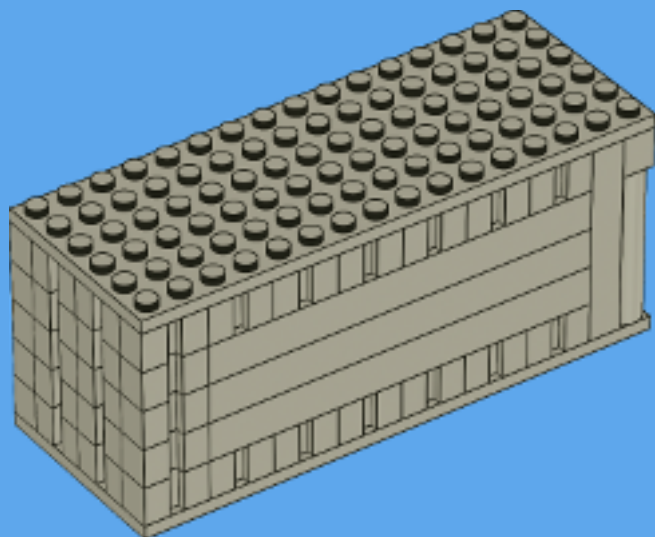

4x

8

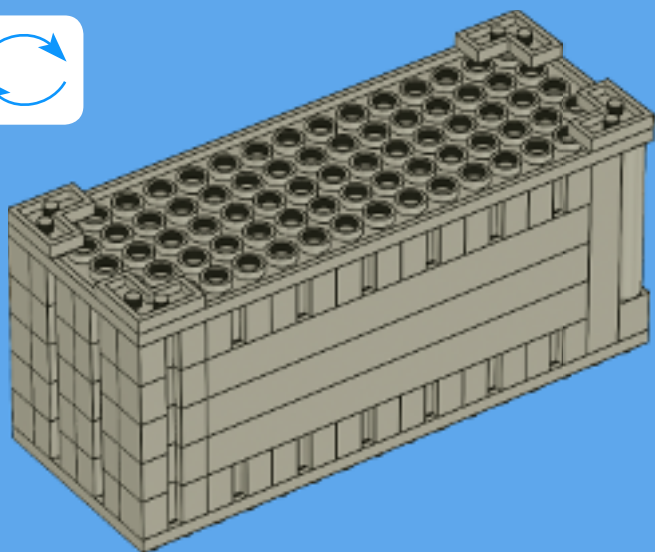



4x

9

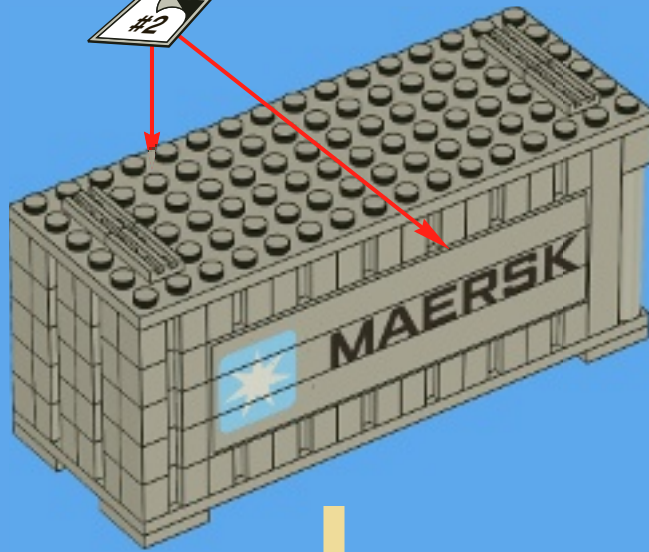

12

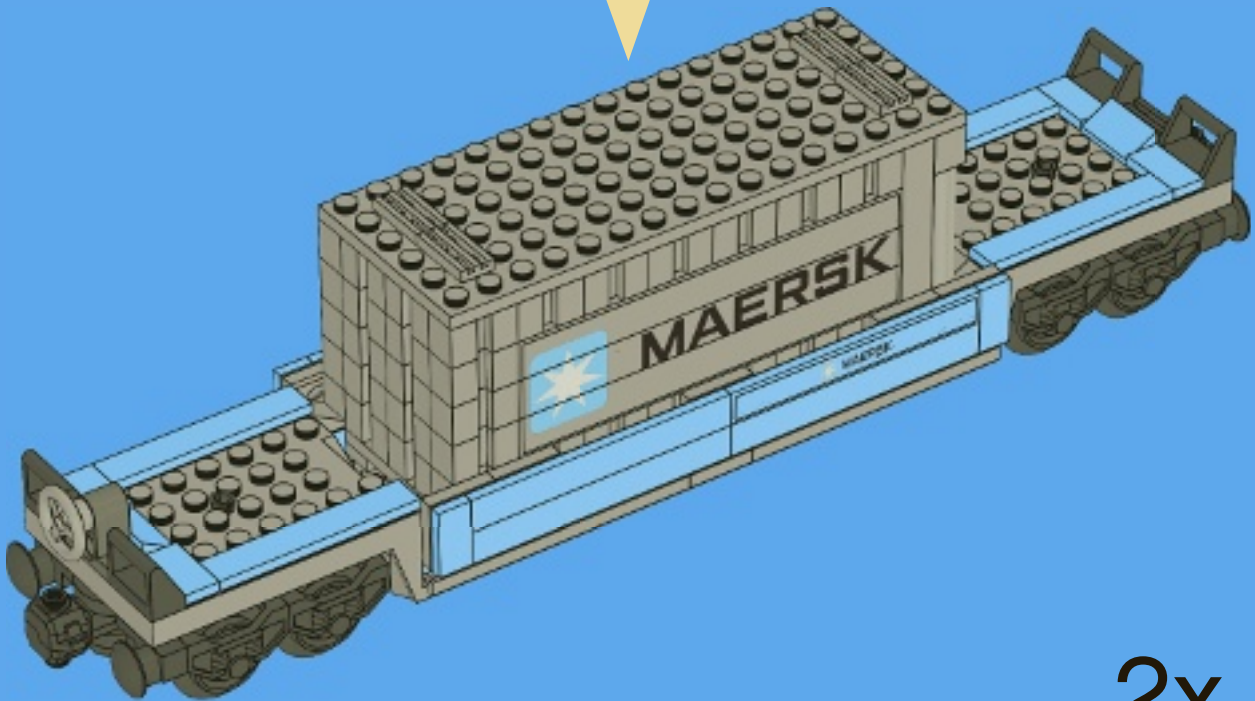

2x

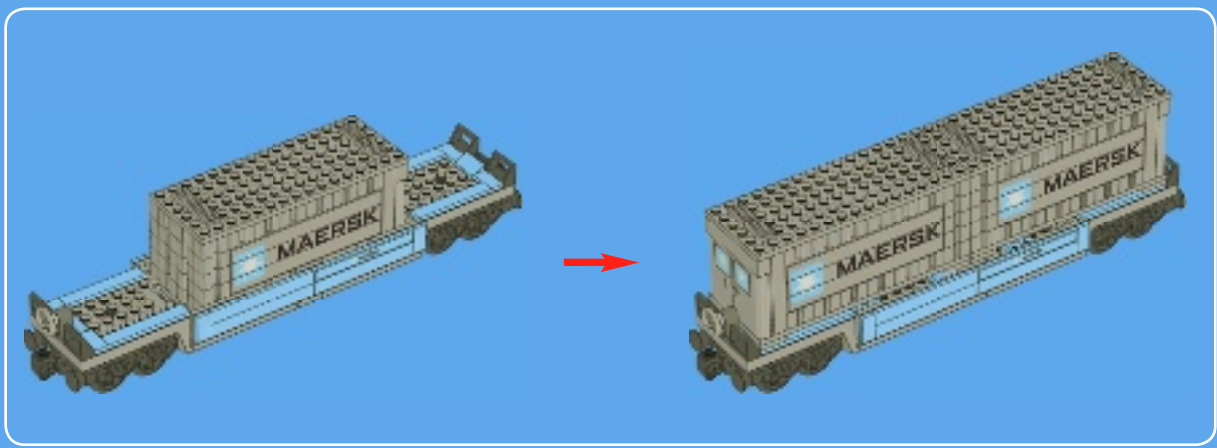

1

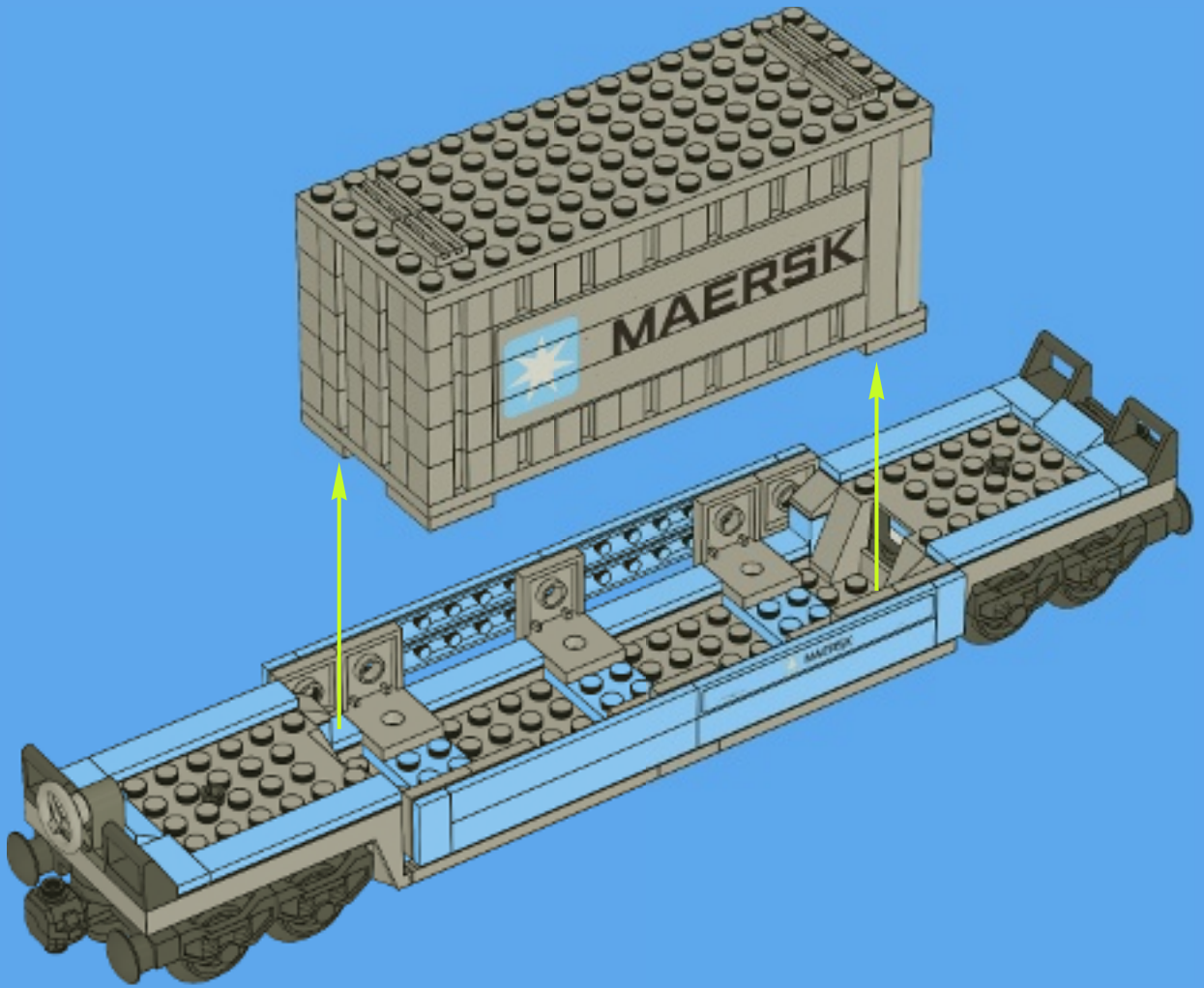



1x



2x

2

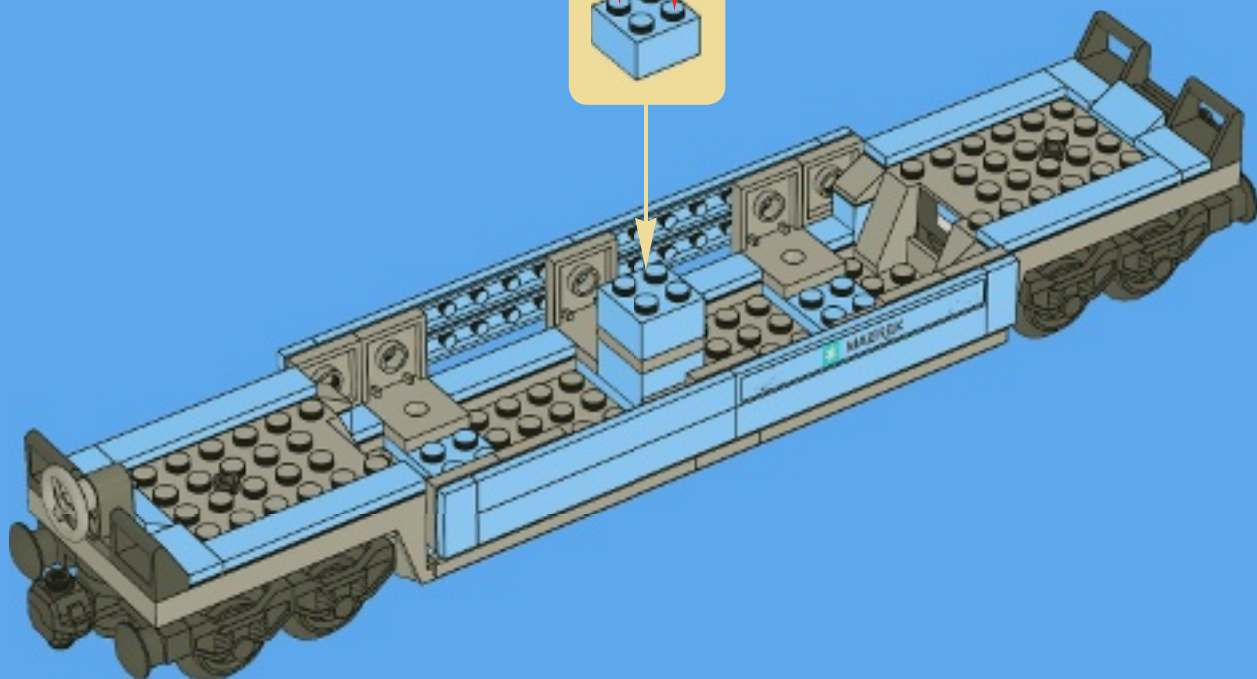
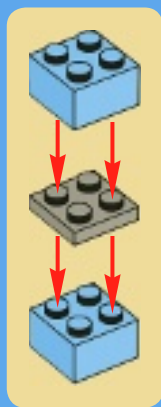

3

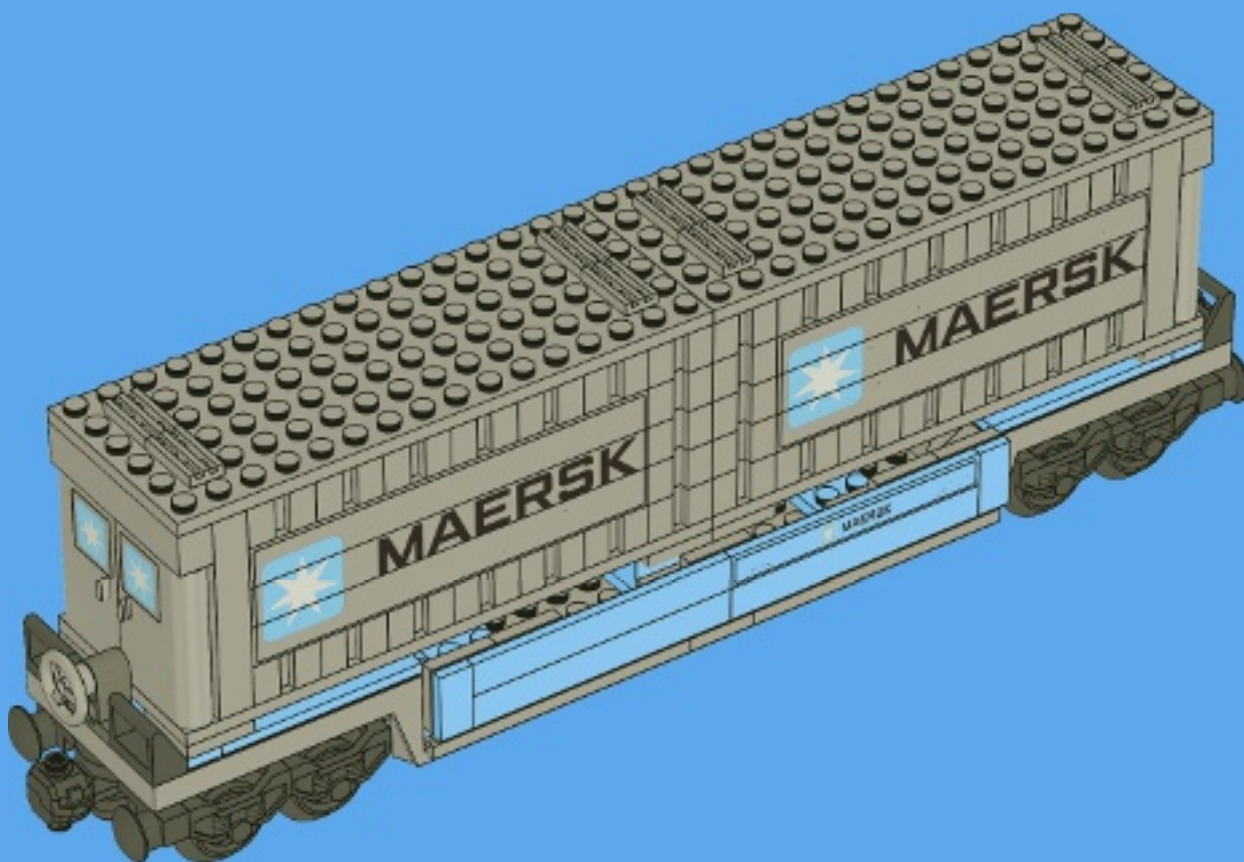



1



2

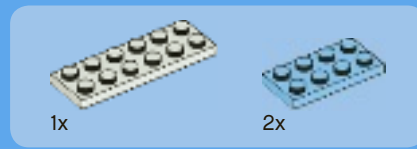
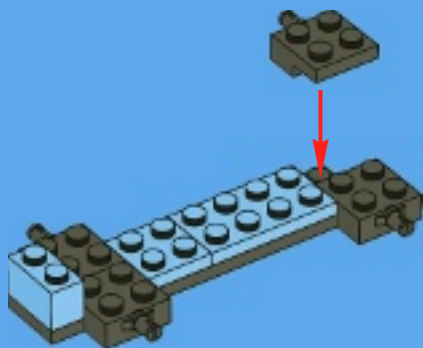

3

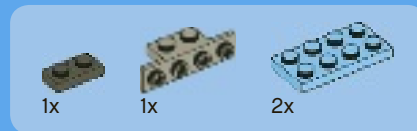
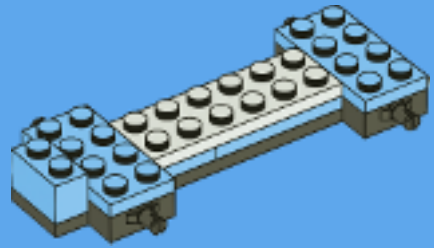

4

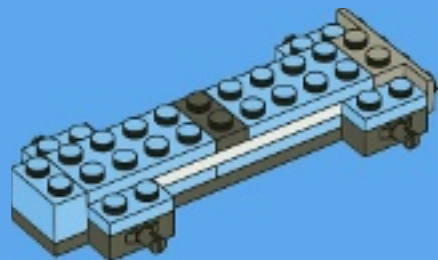

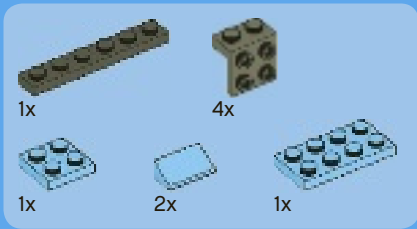

5

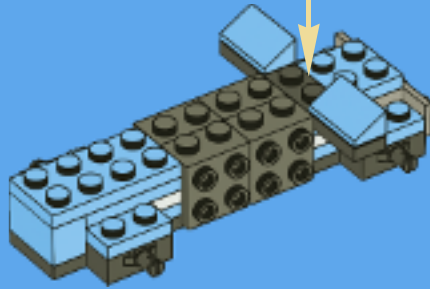
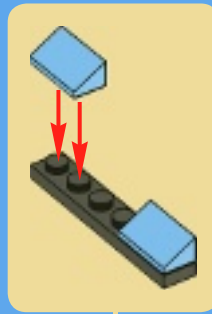

6

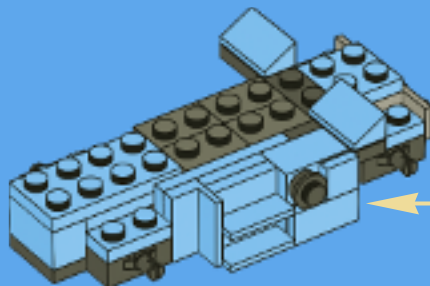
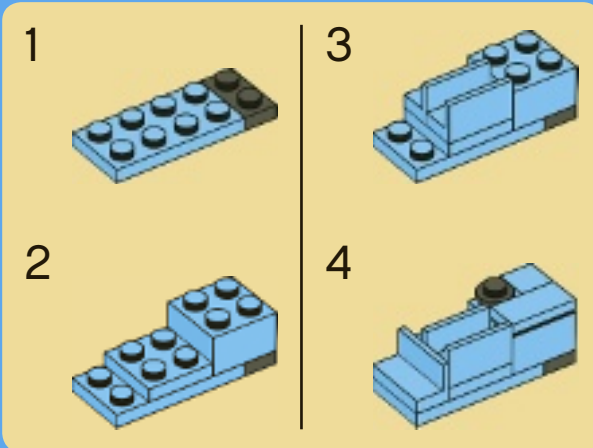

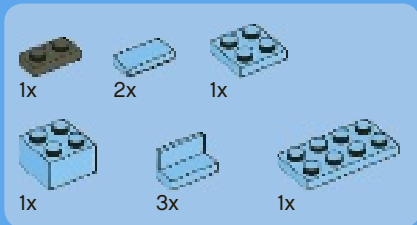

7

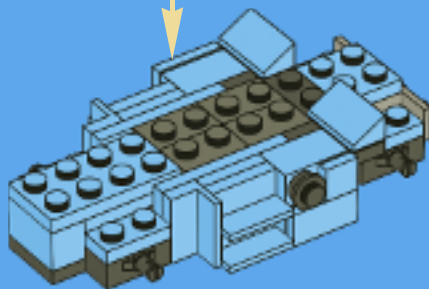
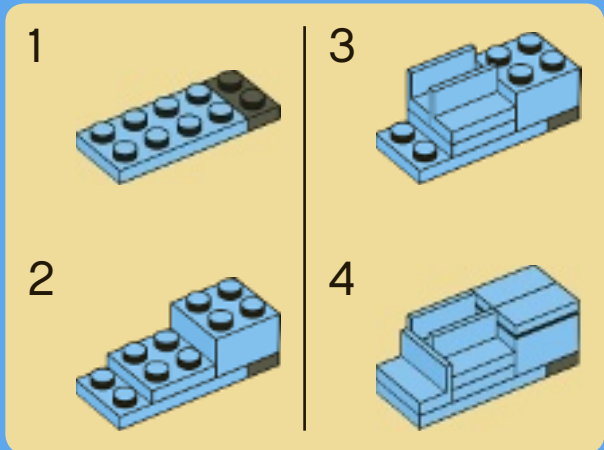

8

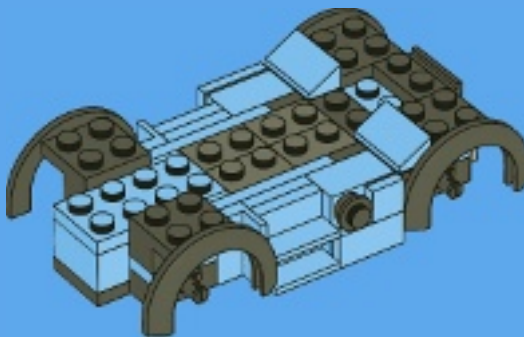

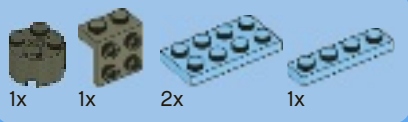

9

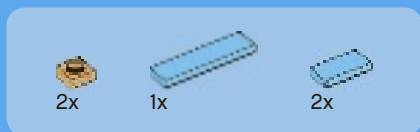
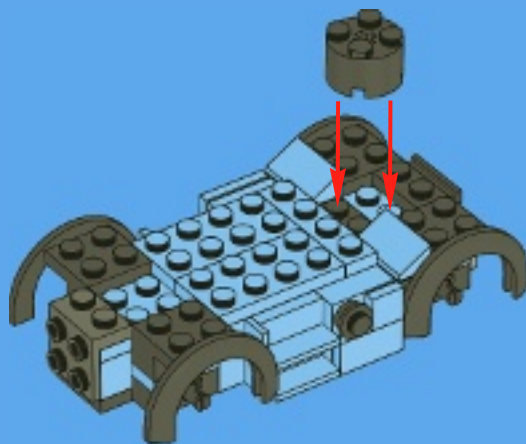

10

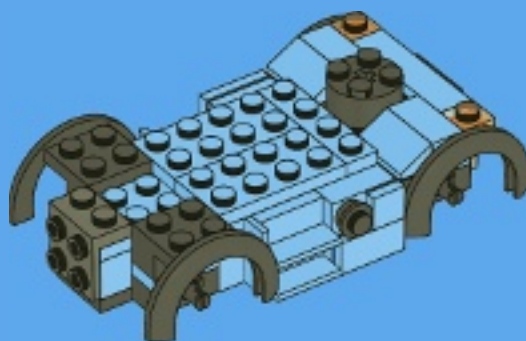



1

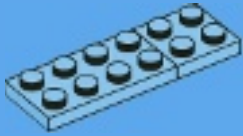

2

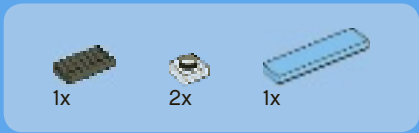
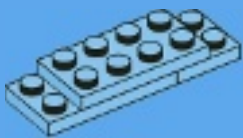

3

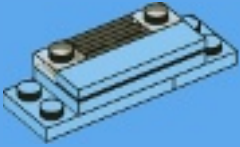

4

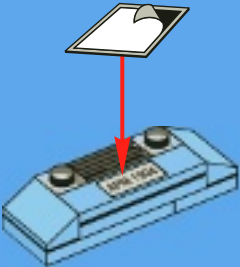



4x



2x



2x

5

1

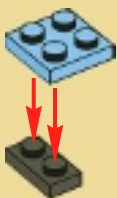

2



2x

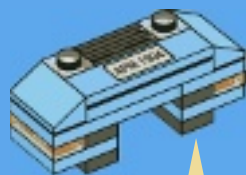

11



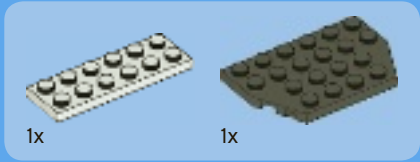
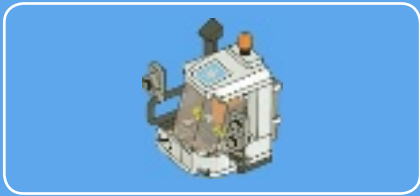

1

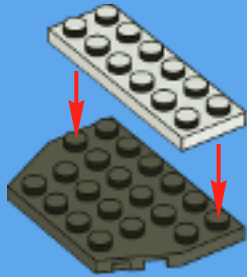

2



3

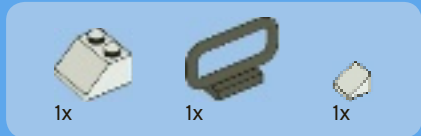
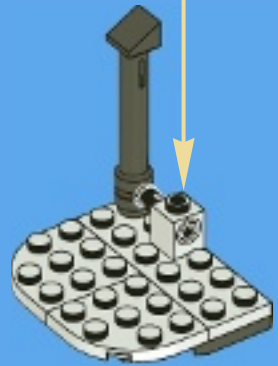
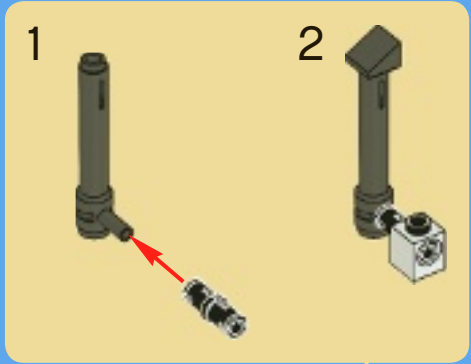

4



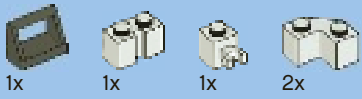

5

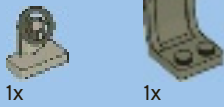
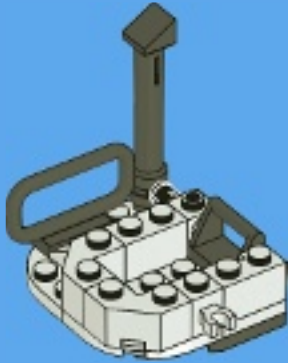

6

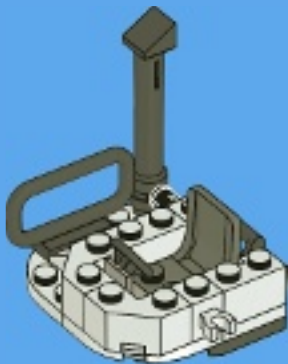

7

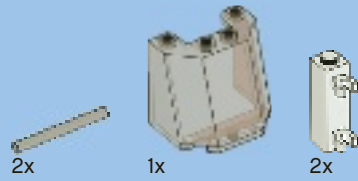

8

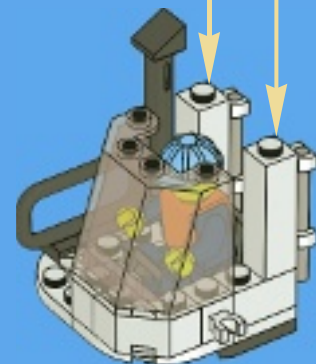
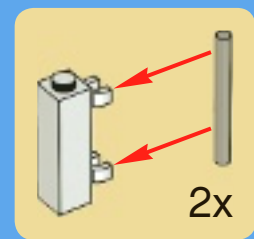



9

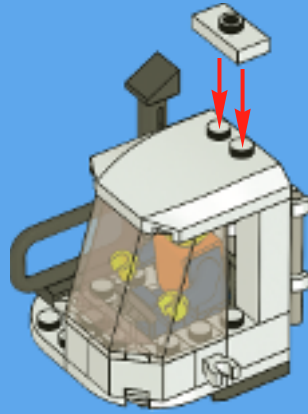

10

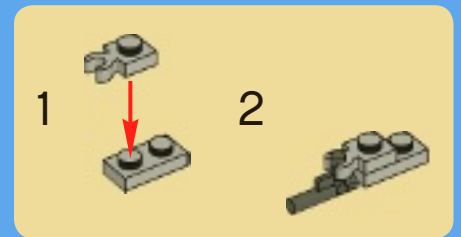
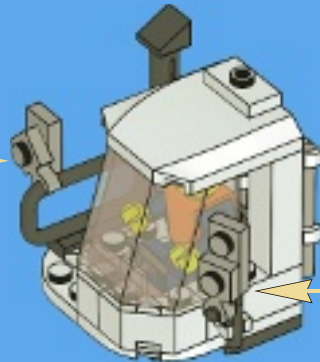
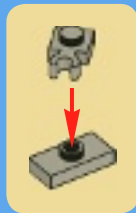

11

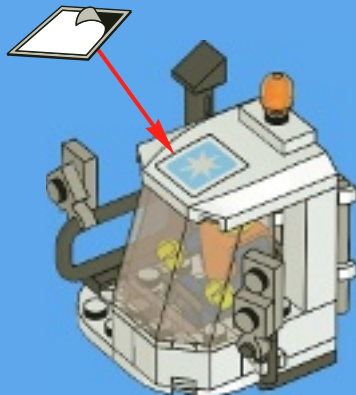

12

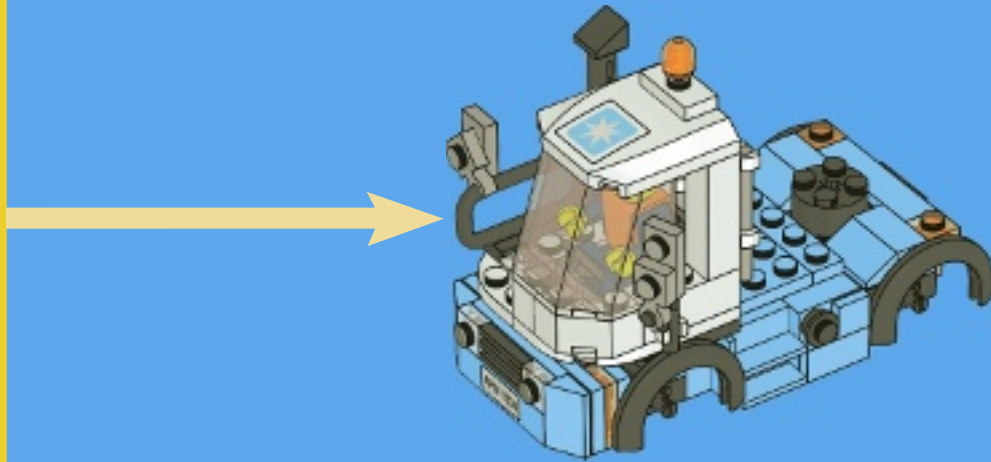

4x



4x

13



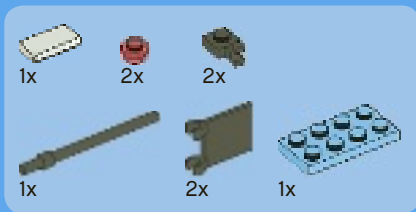

14

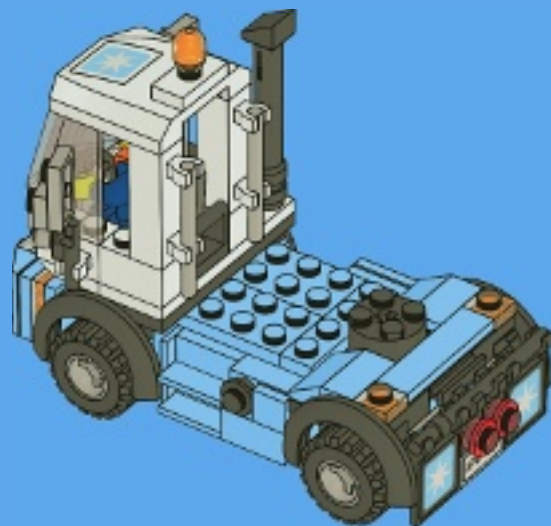

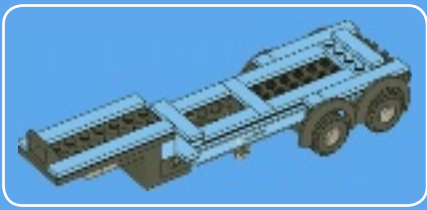

1

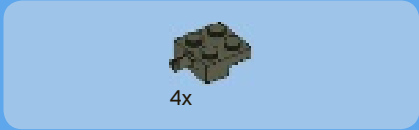
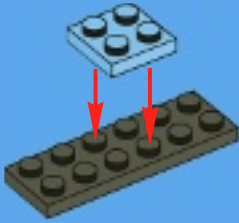

2



3



4

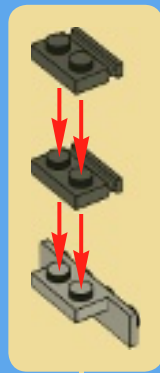



5

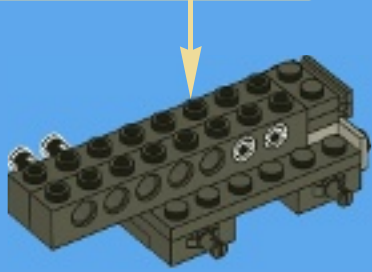
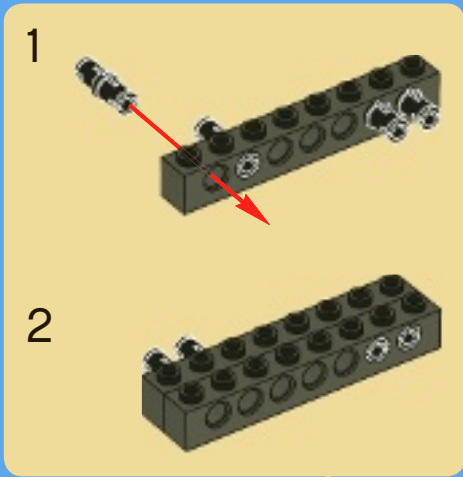

6

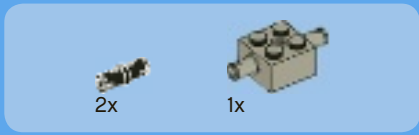

7

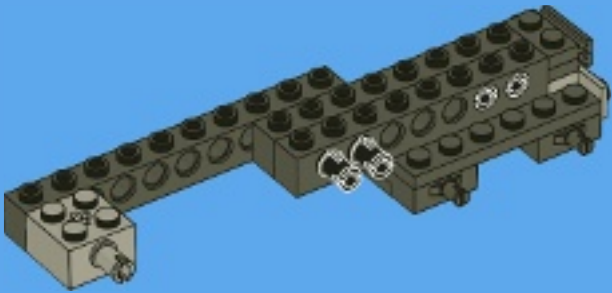

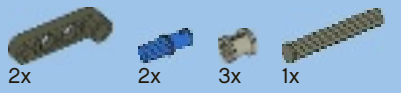

8

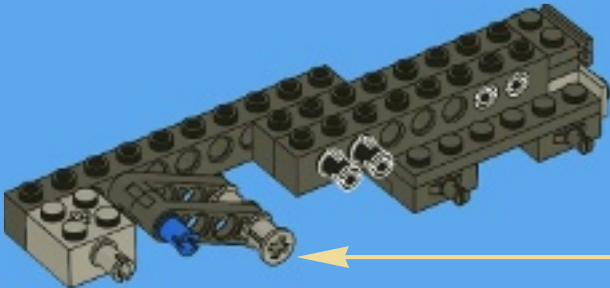

9

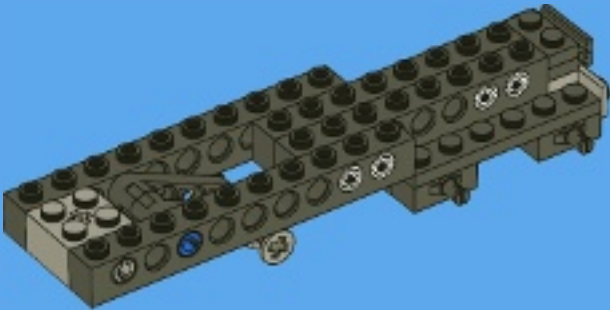



4x

10

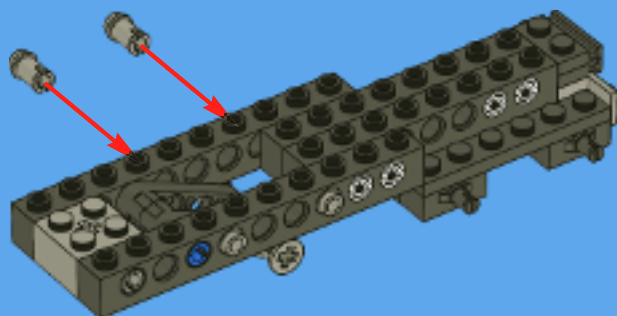

4x



2x

11

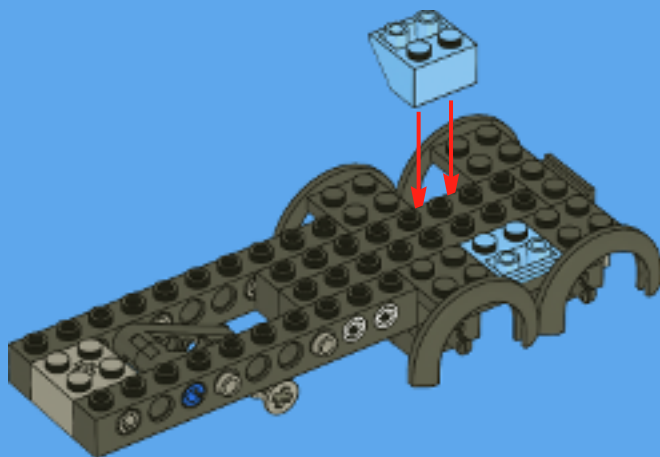

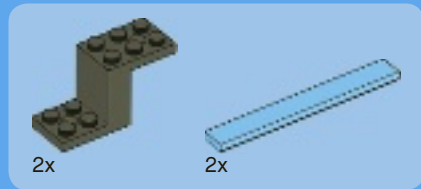

12

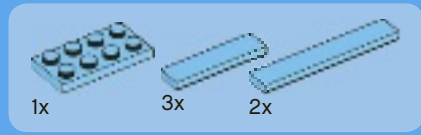
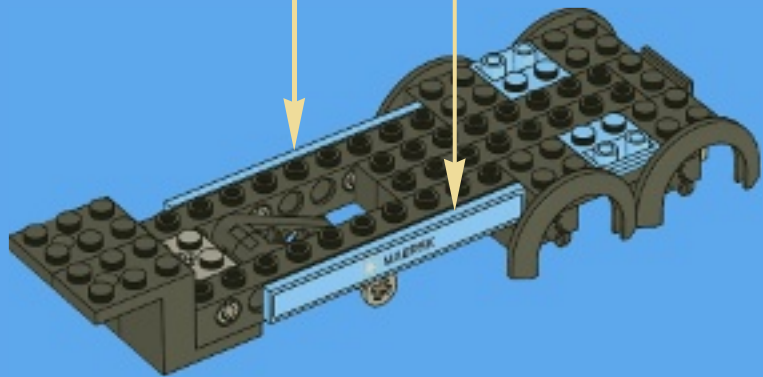
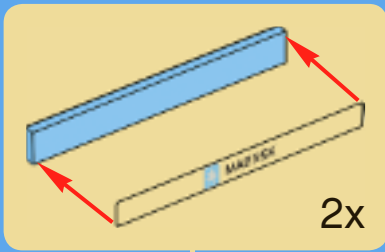

13

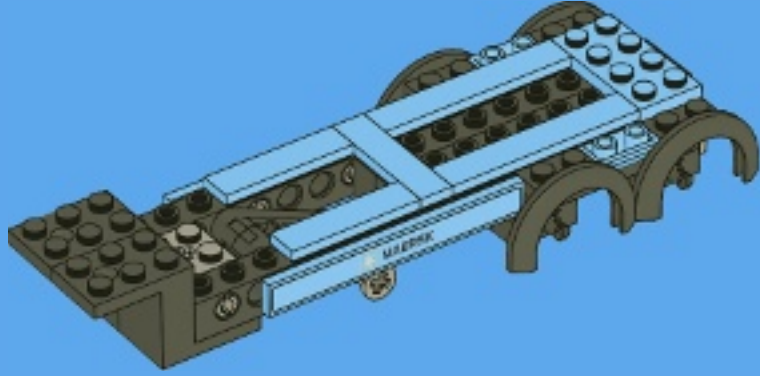

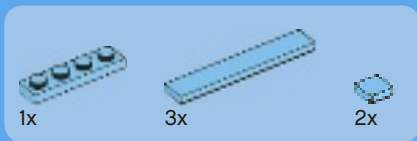

14

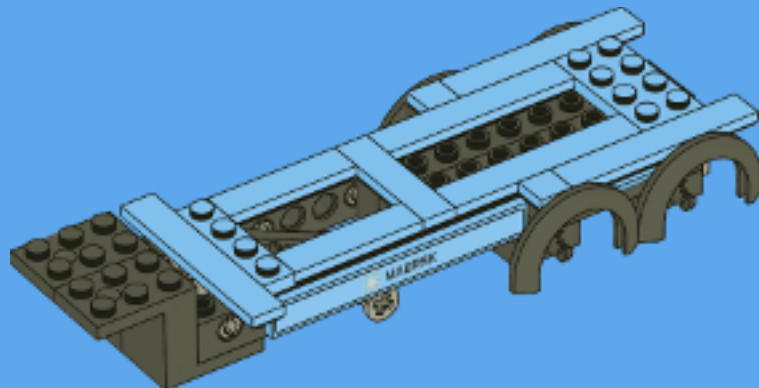

15

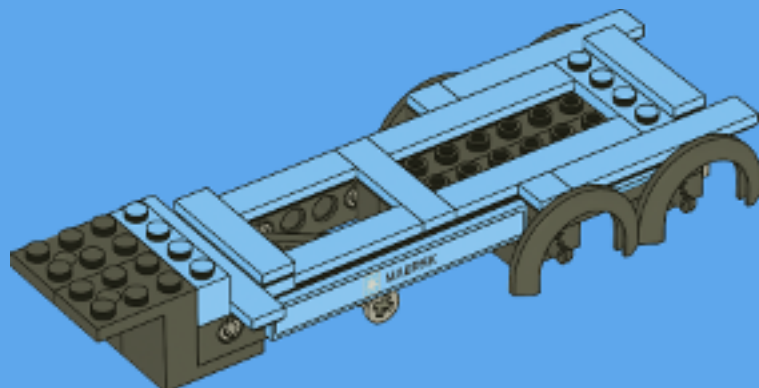



16

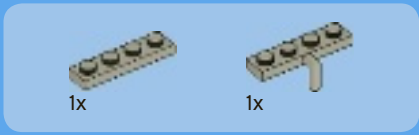
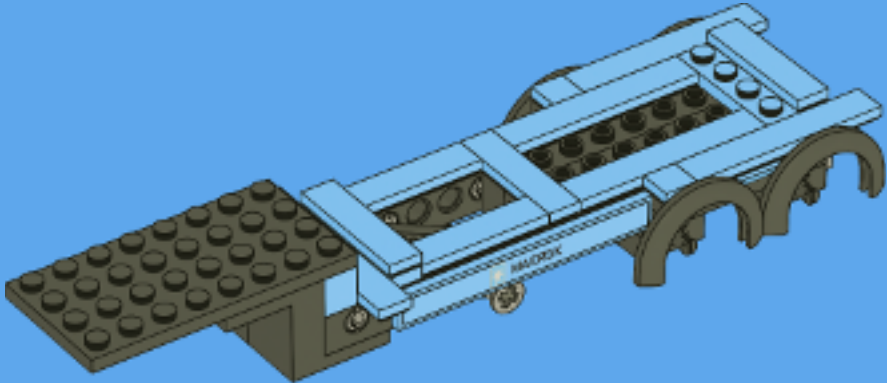

17

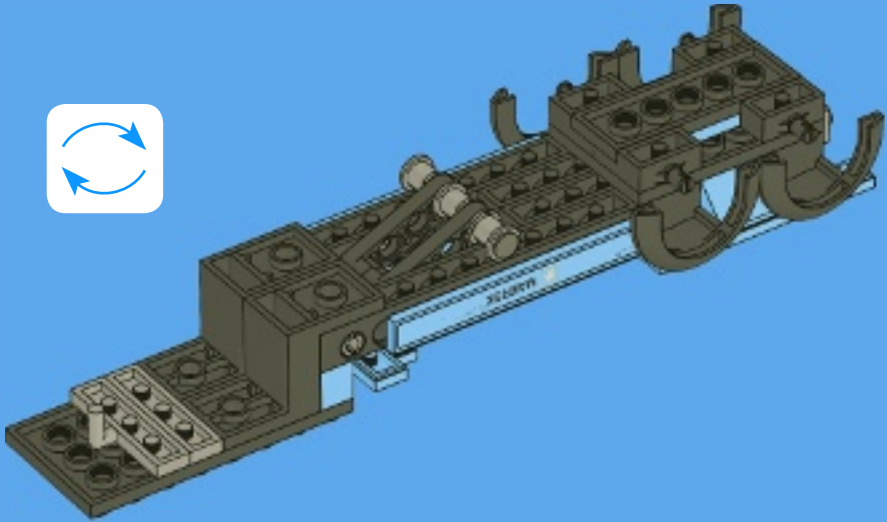



4x



4x

18

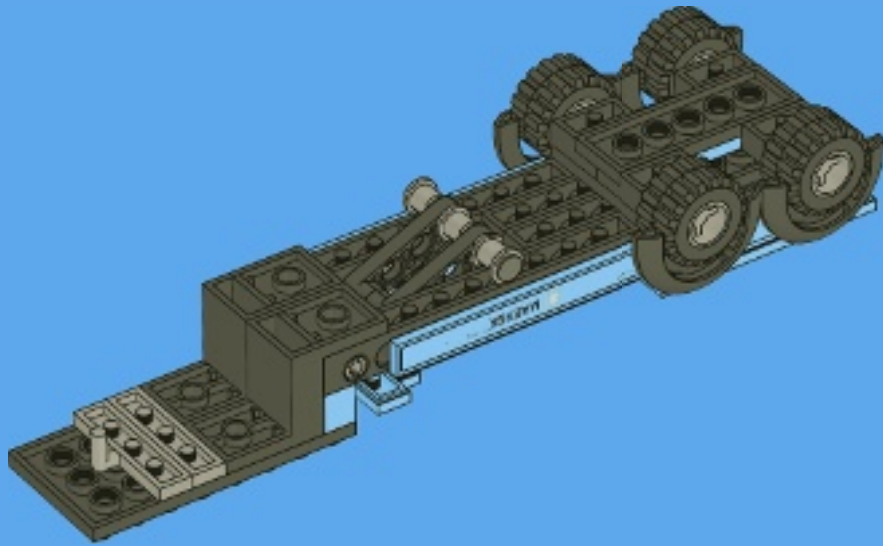

1x



2x



2x



1x



2x



1x

19

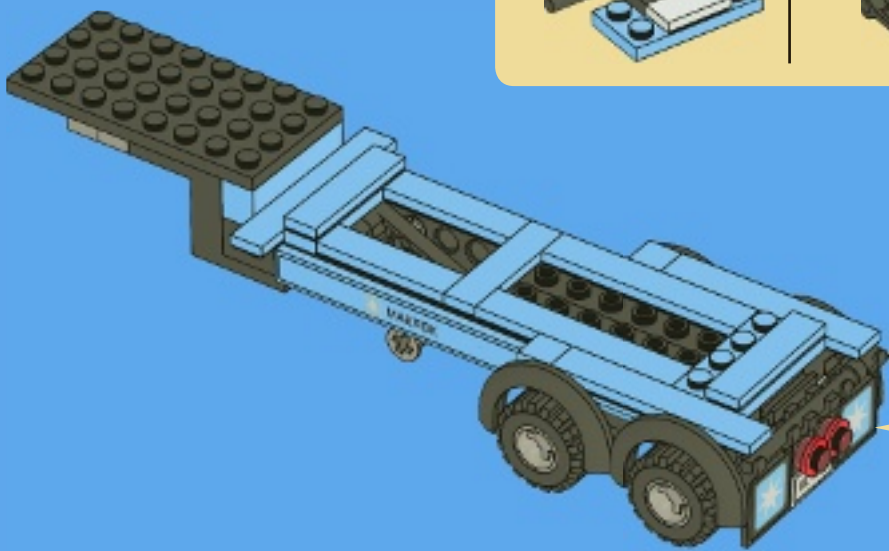

1

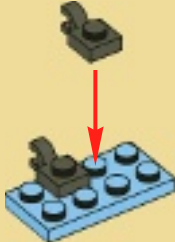

2



3



4





1x



2x



1:1

20

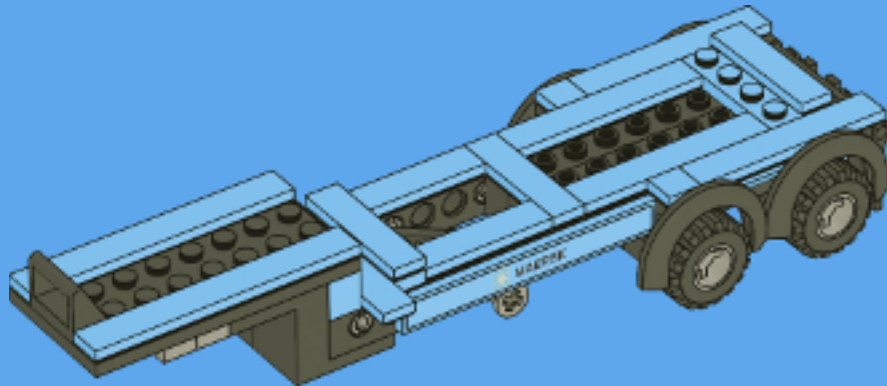

15

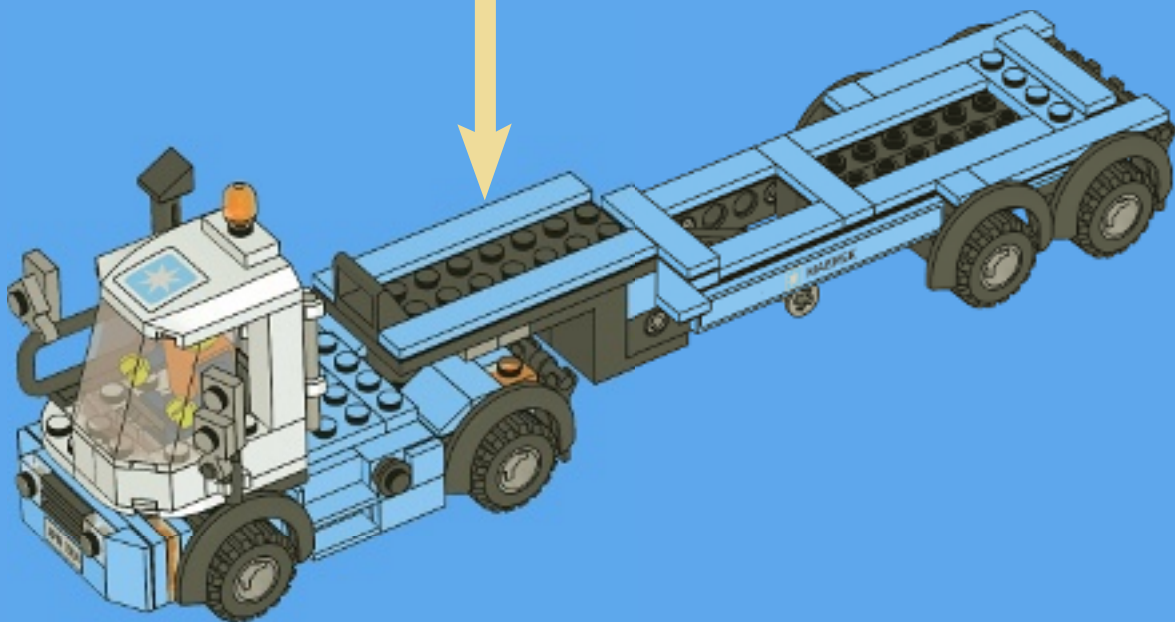

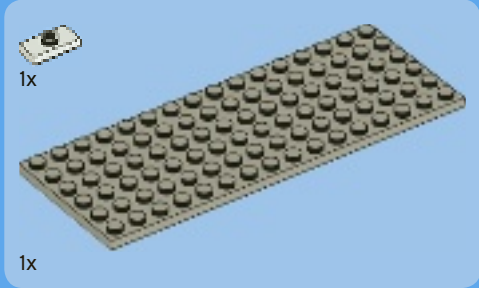

1

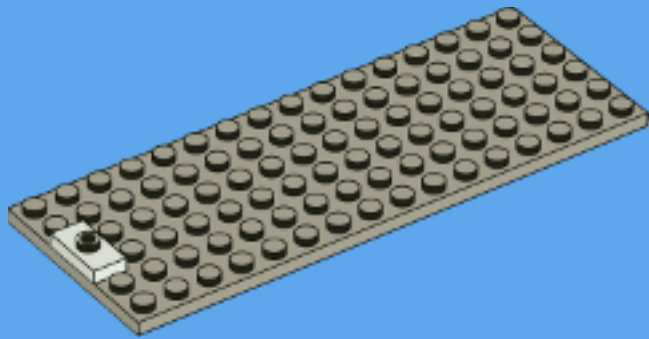

2

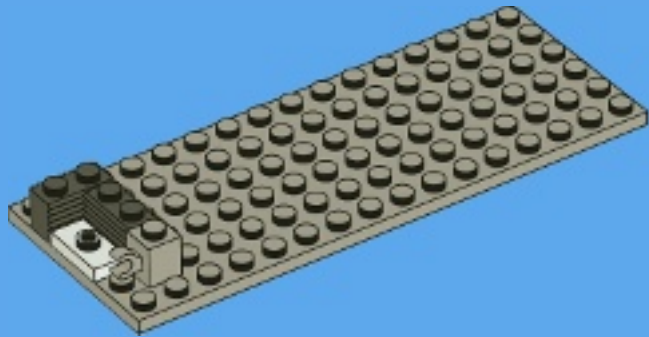



12x

3

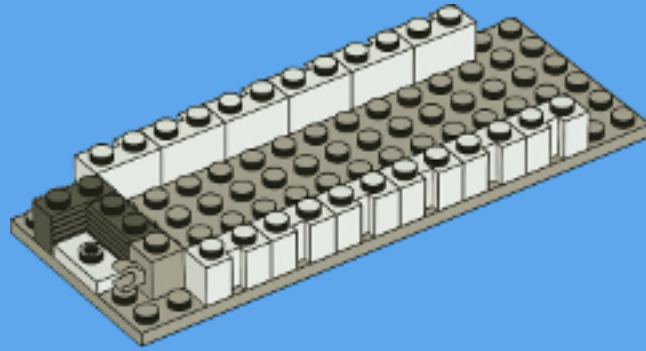

1x



1x



1x



1x

4

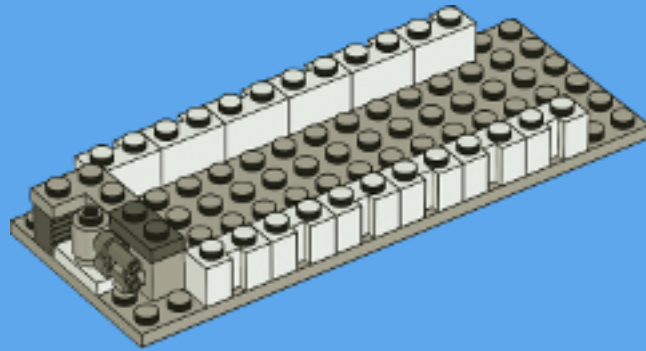

1x



1x

5

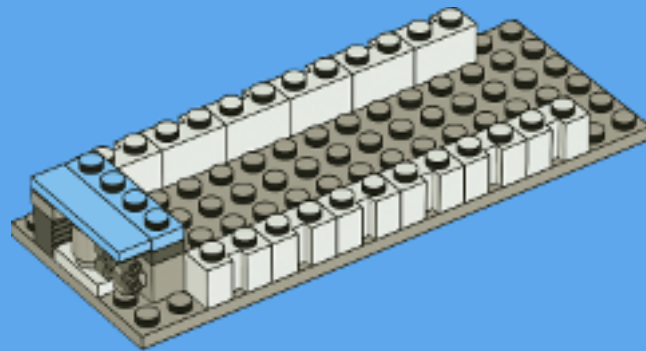

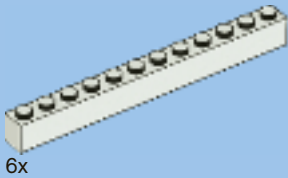

6x

6

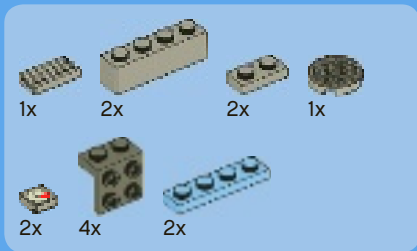
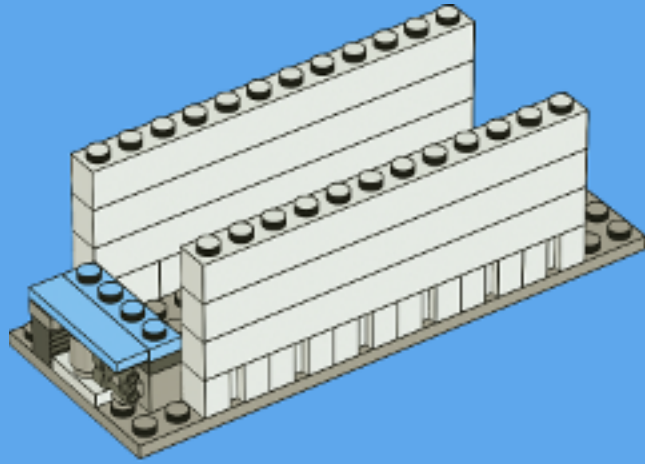

7

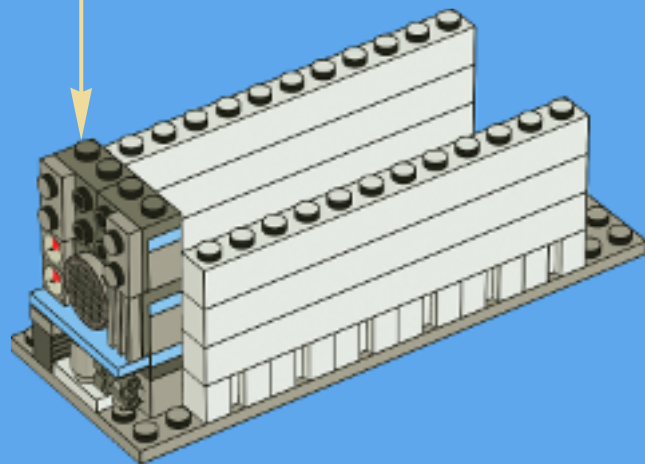
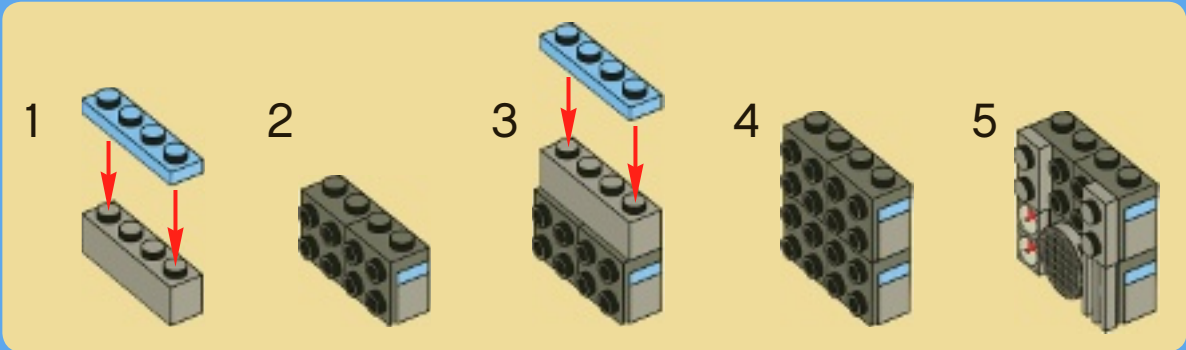

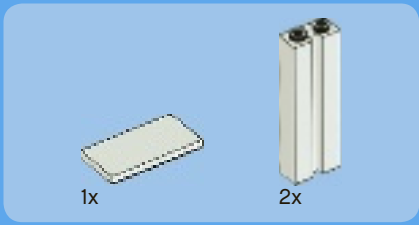

8

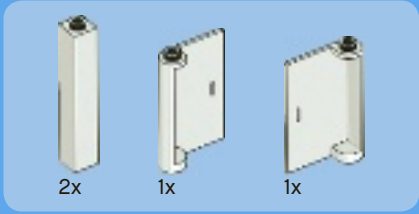
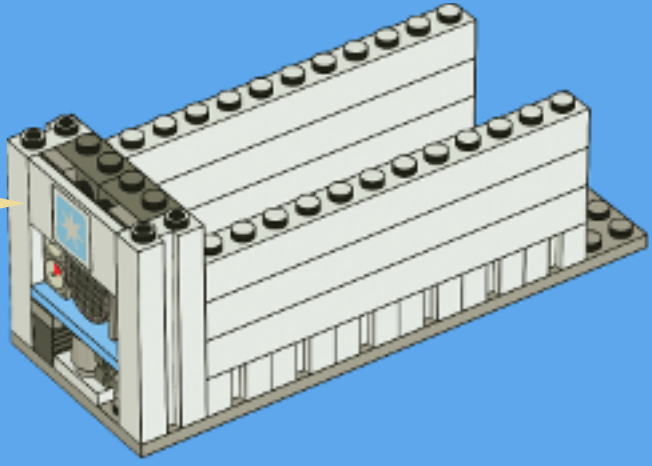
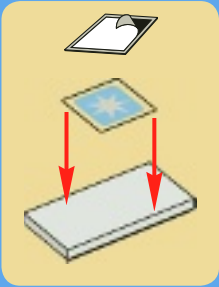

9

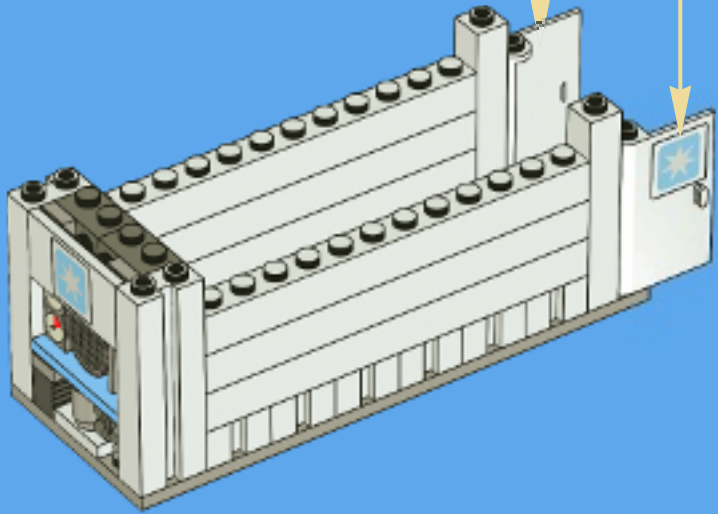
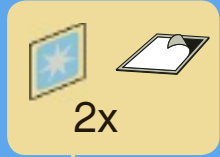



1x



12x

10

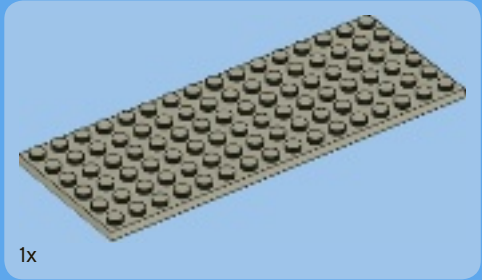
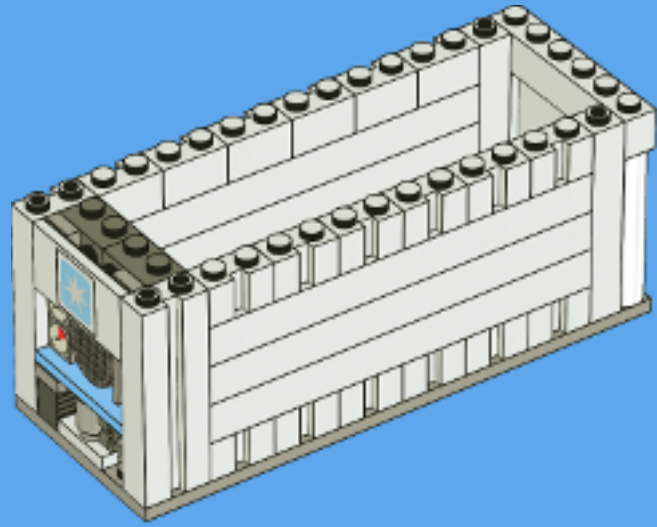

1x

11

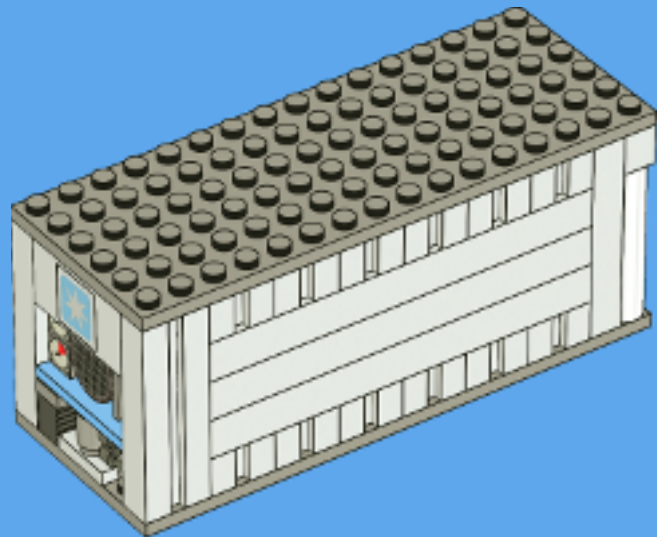



4x

12

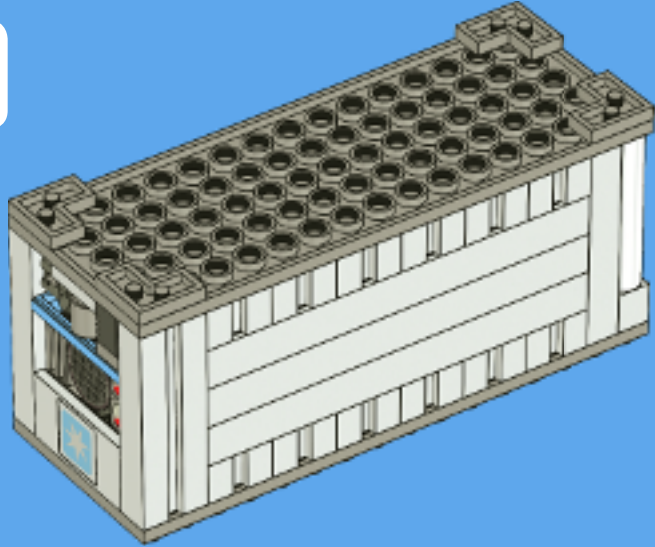

4x

13

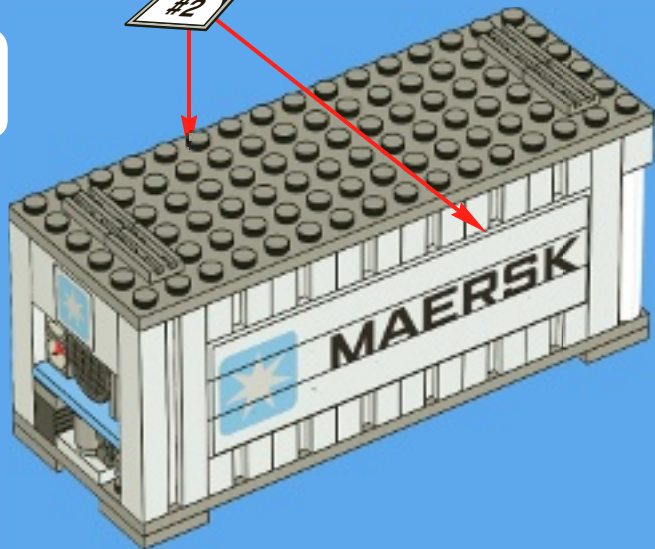

16





2x 245301
2x 300901
6x 611201
1x 4533763
2x 4563684
28x 4264360
2x 4582155
2x 4560939
2x 654101
7x 4504369
1x 303901
4x 306901
28x 302301
2x 362301
1x 4560178
1x 366601
7x 379501
4x 416201

2x 379401
6x 4560929
2x 4550745
1x 4506667
1x 4506668
1x 4193068
11x 4585671
10x 4585673
6x 4585678
3x 4585675
13x 4585667
5x 4585679
24x 4616412
2x 4585681
1x 4585682
16x 4585684
24x 4585669
17x 4585677
16x 4616411

16x 4585663
24x 4585664
15x 4585685
20x 4585686
6x 4585687
3x 4616409
1x 4569056
2x 4603263
4x 4206482
1x 4549896
1x 4194017
1x 4262093
1x 4570663
4x 300526
1x 300326
1x 300126
5x 407026
6x 287726
2x 4100423
1x 614326

2x 370226
6x 273026
5x 4504382
13x 4541191
2x 4121966
2x 4548180
2x 303726
4x 609126
3x 4200023
2x 4200031
4x 307026
21x 306926
27x 302326
14x 302226
2x 362326
9x 4558170
8x 302126
10x 4599499
11x 366626
1x 4243819

1x 617926
5x 379526
2x 303226
4x 447726
1x 303526
1x 383226
2x 4514845
2x 303026
8x 4517925
6x 379426
19x 241226
2x 4144575
9x 4107761
4x 4535739
8x 448826
10x 4297713
9x 370926

6x 402526
5x 614126
1x 4129572
2x 4106347
10x 243226
9x 486526
1x 4141349
2x 658326
2x 4538456
4x 4523405
4x 4140303
2x 4538722
18x 4223247
1x 400626
1x 4537551
8x 4514560
4x 4517986
2x 4107136
4x 4218868



4x
4581556

1x
4616992

16x
4496343

8x
4621116

2x
4589489

4x
4589495

8x
287826

4x
4493326

8x
4260488

2x
4143372

1x
4569407

4x
4109810

7x
4121715

6x
4526982

4x
370626

2x
3000840

8x
3005740

6x
4552035

4x
3005741

3x
4210280

1x
4543458

8x
4298979

3x
4162916

3x
4625068

2x
4542673

2x
4280341

1x
4524365

4x
4211190

4x
4216581

2x
4507833

4x
4211362

3x
4211389

2x
4211428

4x
4211394

5x
4211393

1x
4211795

1x
4535764

89x
4617170

5x
4211752

5x
4211412

12x
4521921

3x
4211519

2x
4255629

3x
4211398

13x
4211353

12x
4211397

5x
4211429

6x
4211445

6x
4560183

10x
4211438

1x
4243797

8x
4211498

2x
4616995

6x
4211733

2x
4211836

12x
4211522

2x
4211838

2x
4211369

2x
4594238

17x
4211350

3x
4211451

4x
4277927

4x
4211568

13x
4211472

2x
4282740

1x
4261605

4x
4211748

8x
4211807

8x
4211483

4x
4211475

1x
4221881

2x
4585429

3x
4617152

2x
4617168

2x
4617109

2x
4211628

8x
4211764

3x
4211701

1x
4226995

4x
4211573

3x
4211622

1x
4211758

26x
4277928

1x
4603504

1x
4217558

4x
4210967

2x
4524930

1x
4211051

4x
4210469

2x
4560177

12x
4558955

1x
4211046

1x
4215740

4x
4210998

8x
4210763

Customer Service
Kundenservice
Service Consommateurs
Servicio Al Consumidor

www.lego.com/service or dial



: 00800 5346 5555

: 1-800-422-5346



10219



8878 + 8887 +
8884 + 8879 + 88002

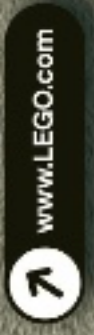
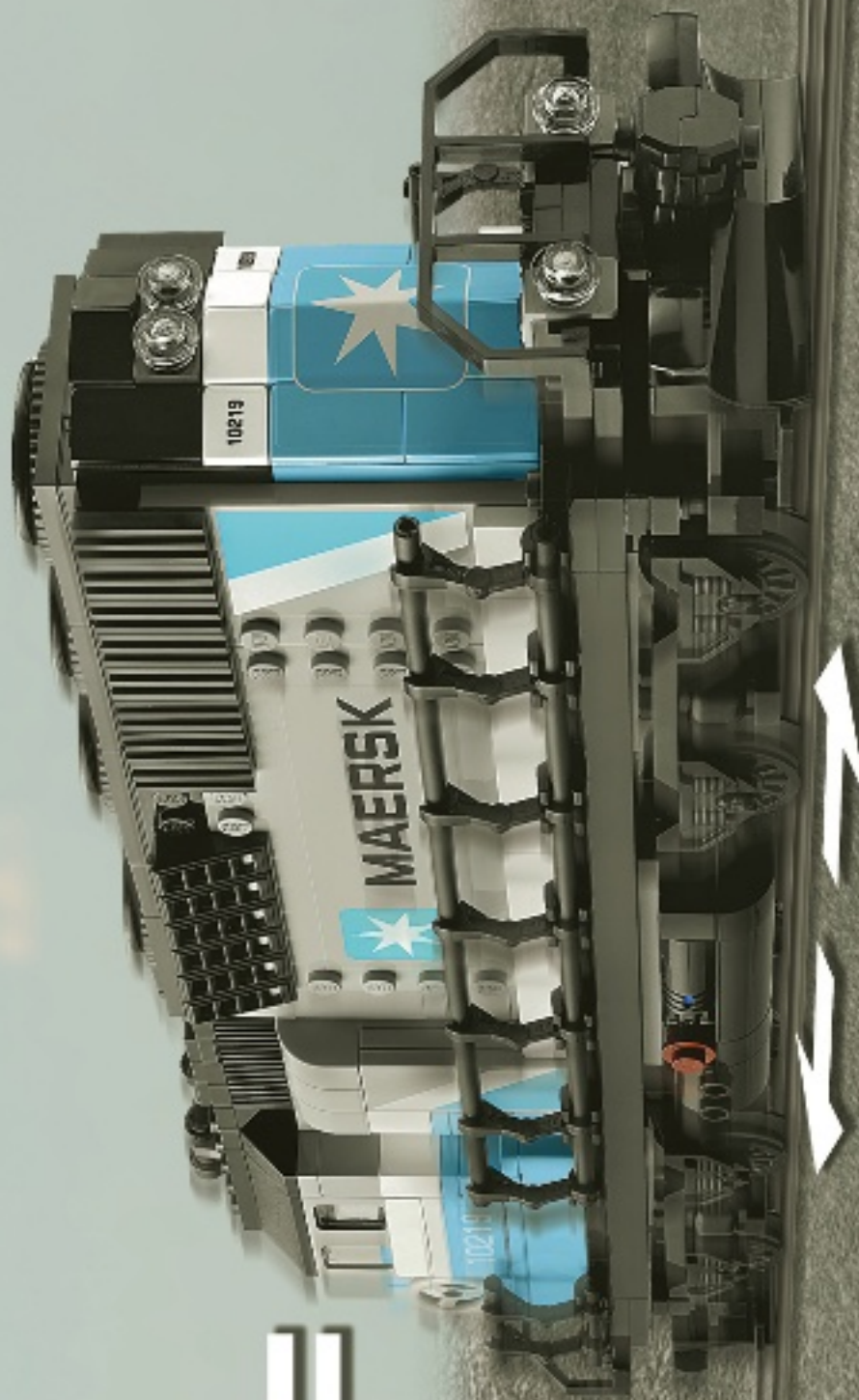

1

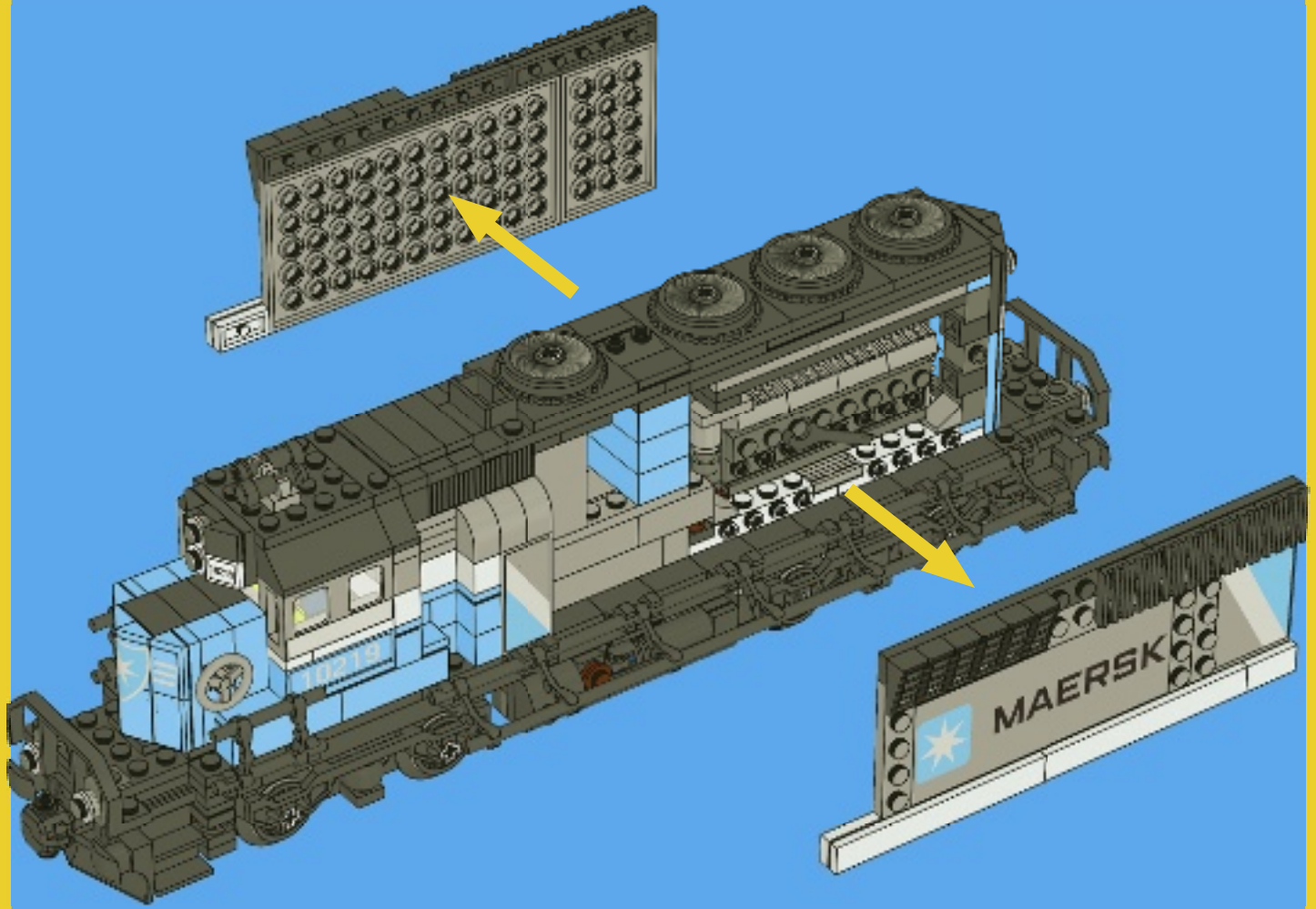

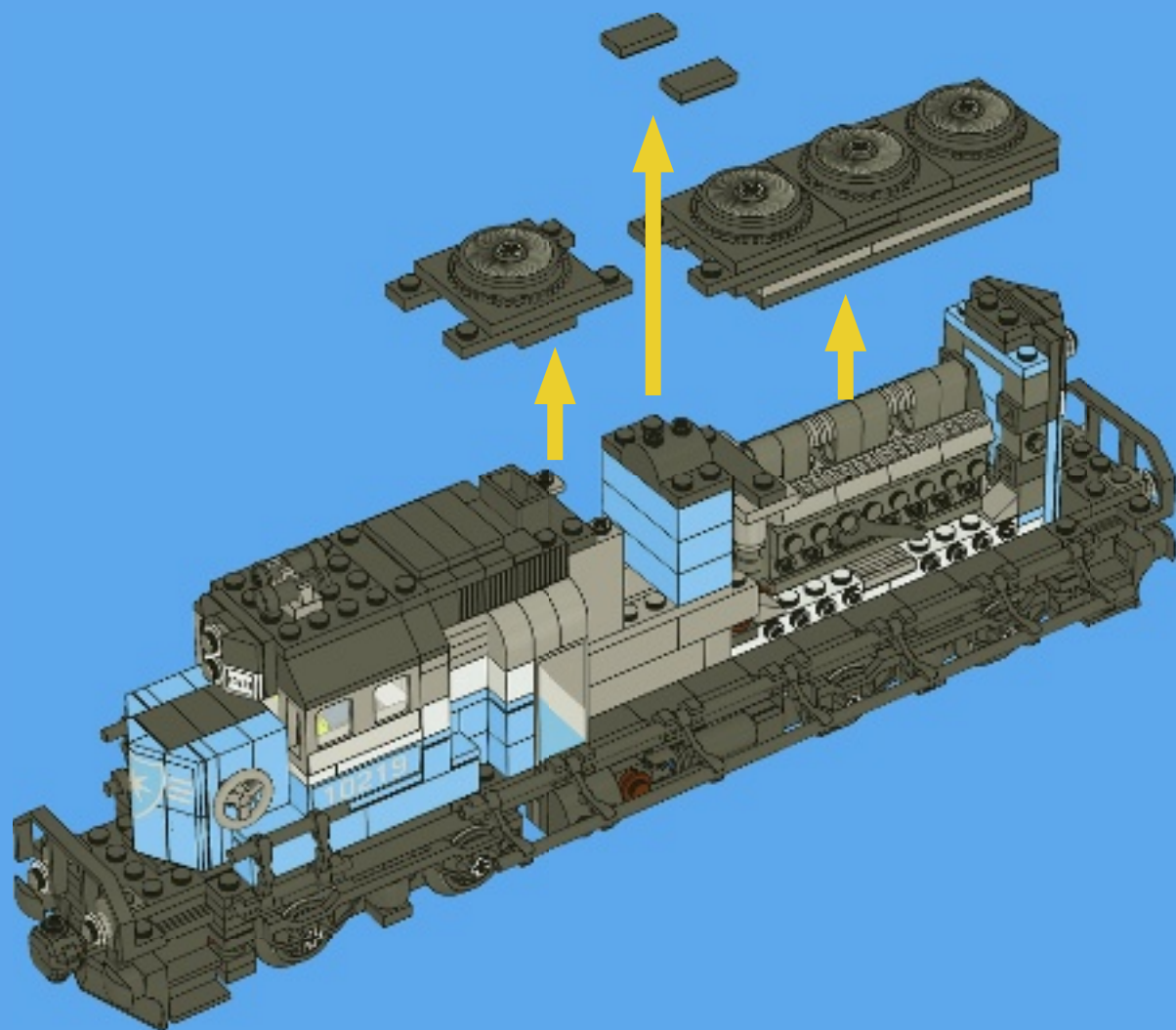

3

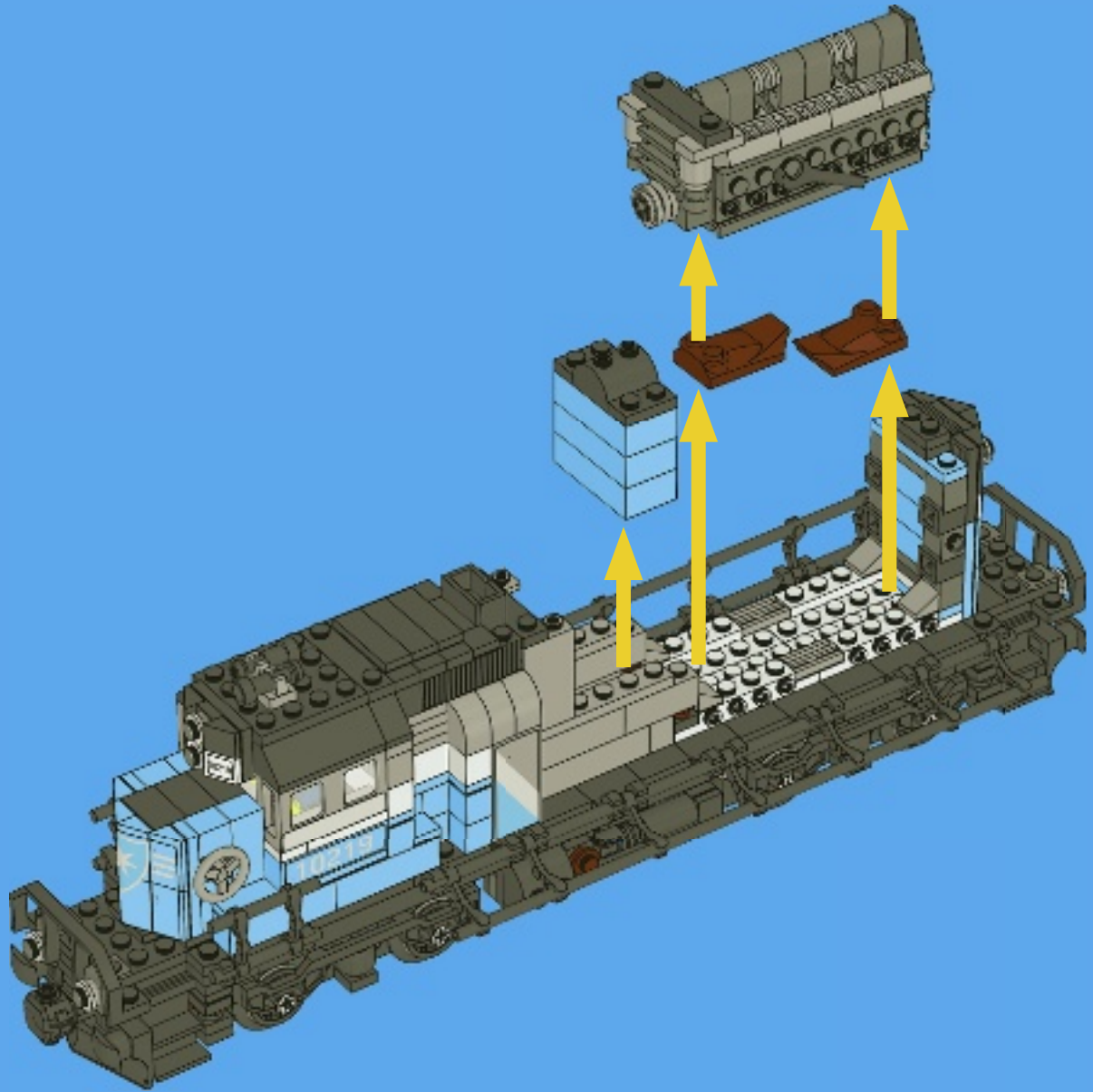

4

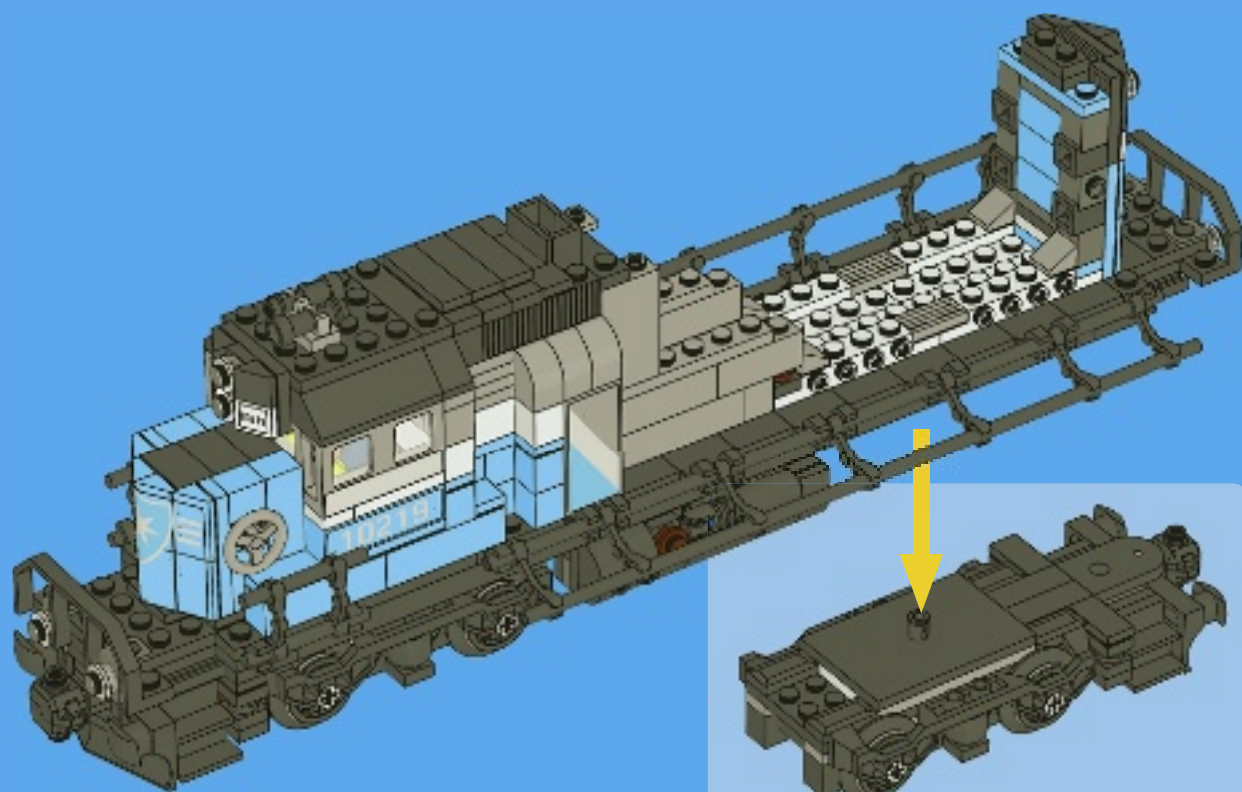

5

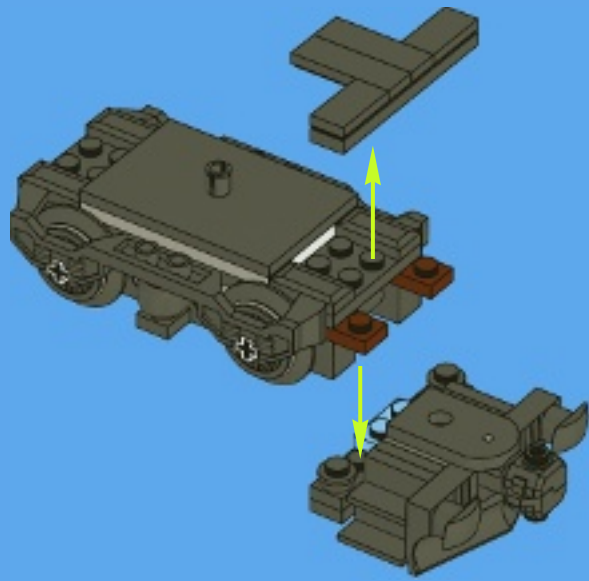

6

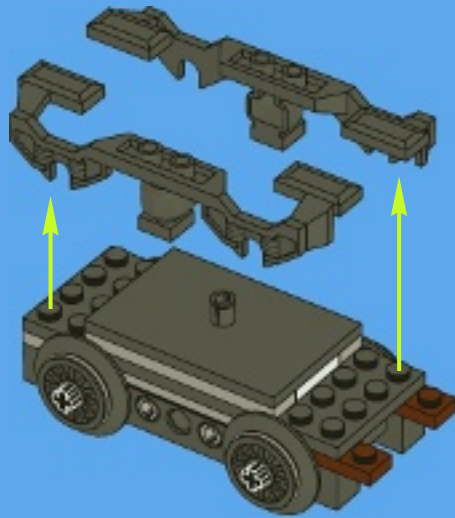

7

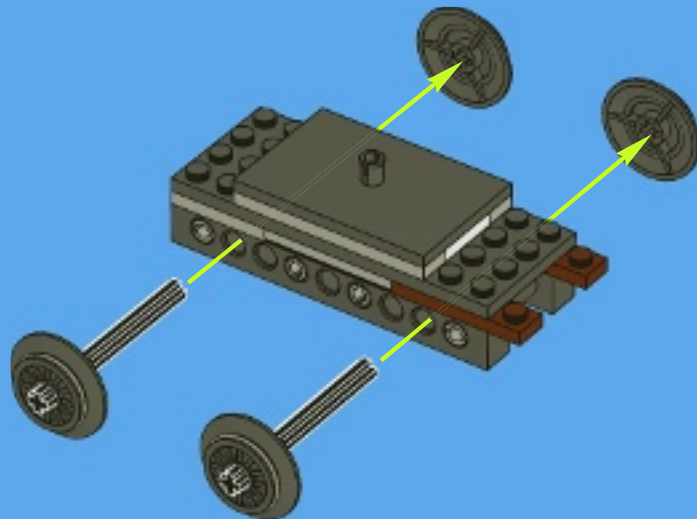

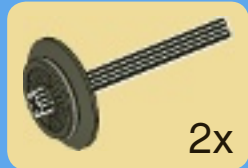
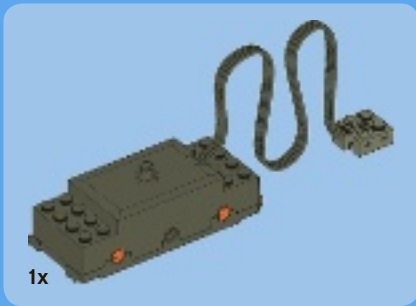

8

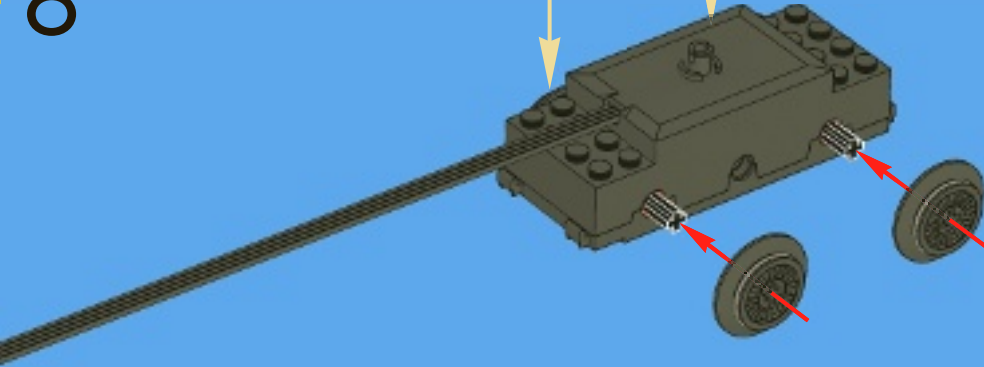

9

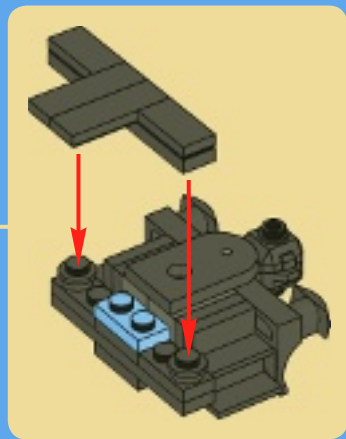
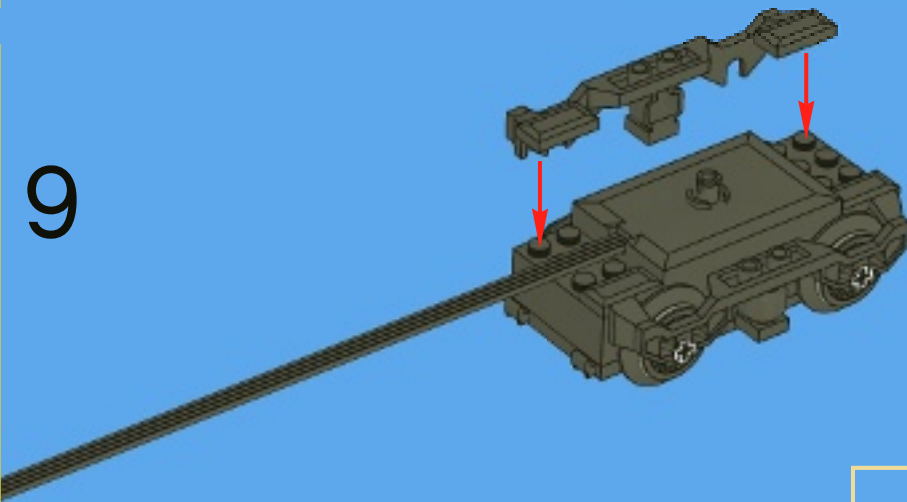

10

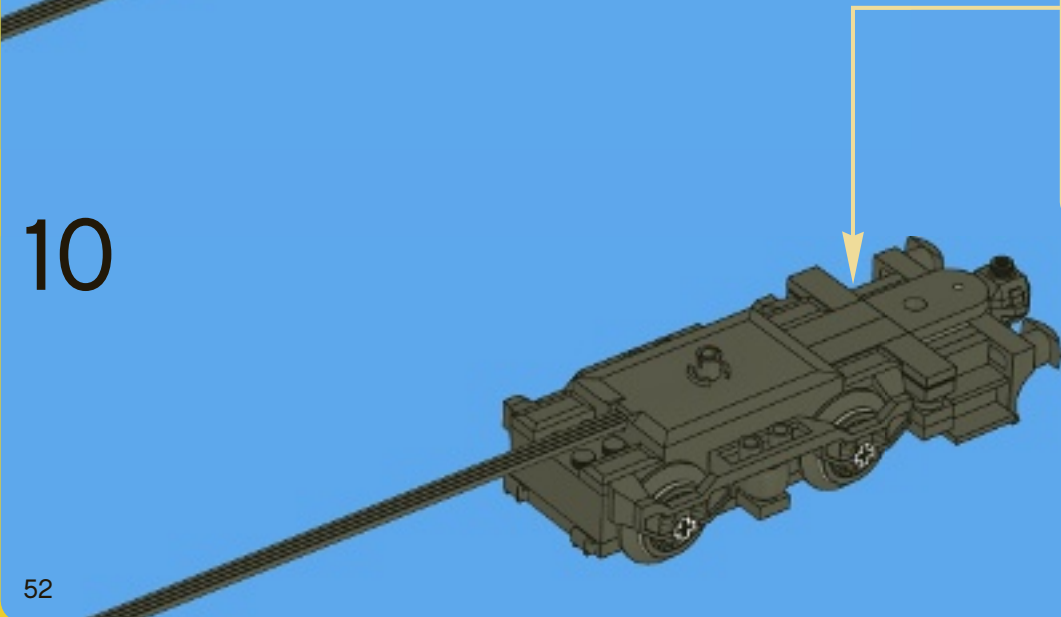

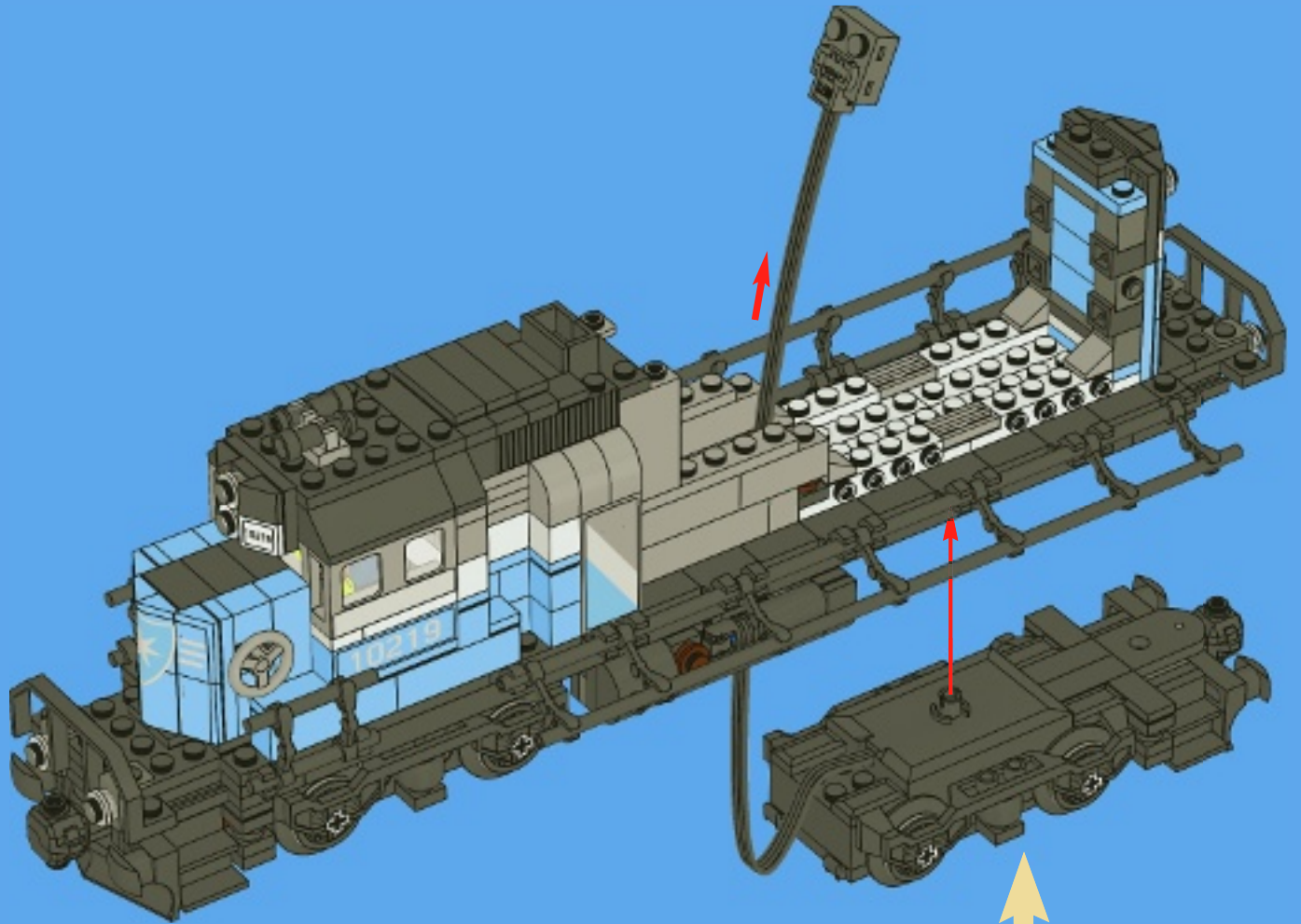

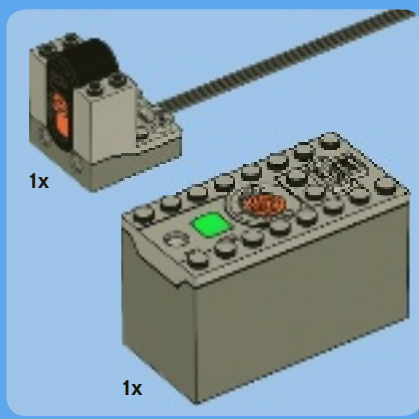

12

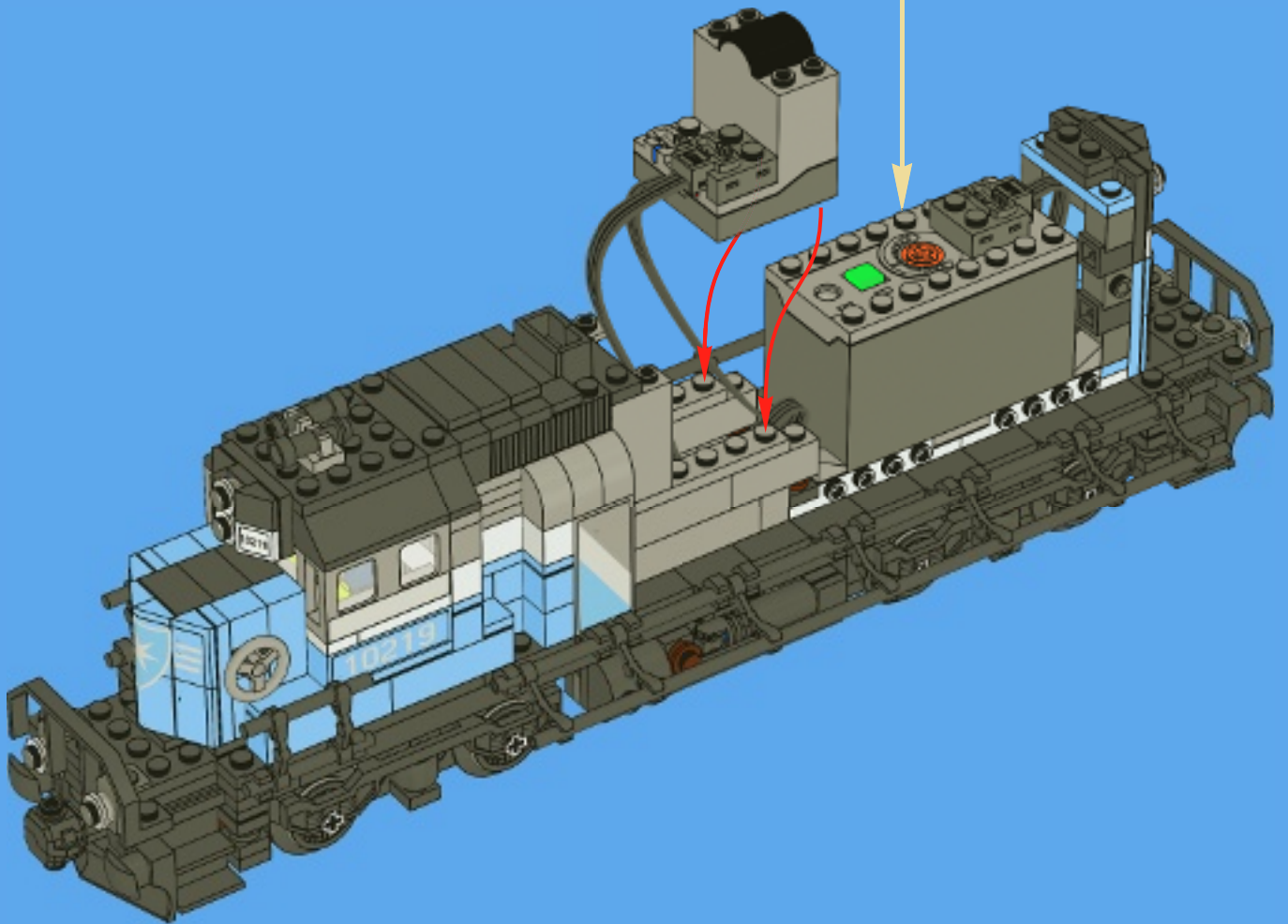
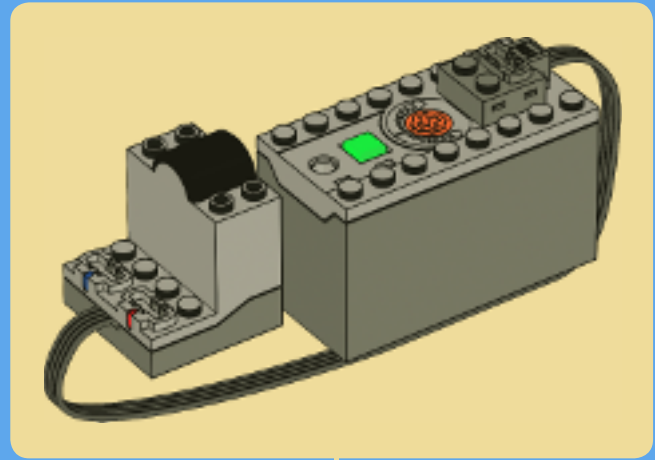

13

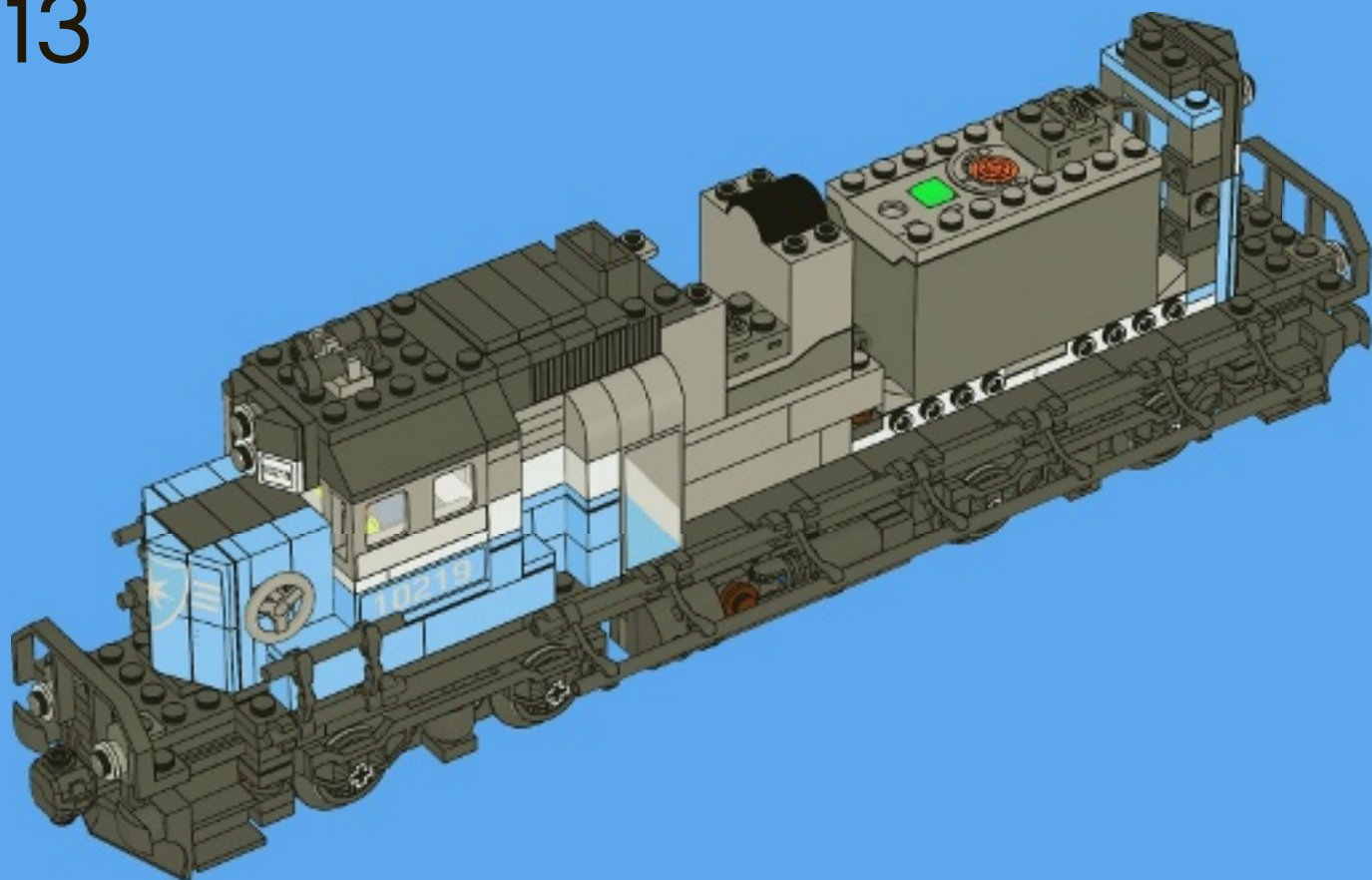

14

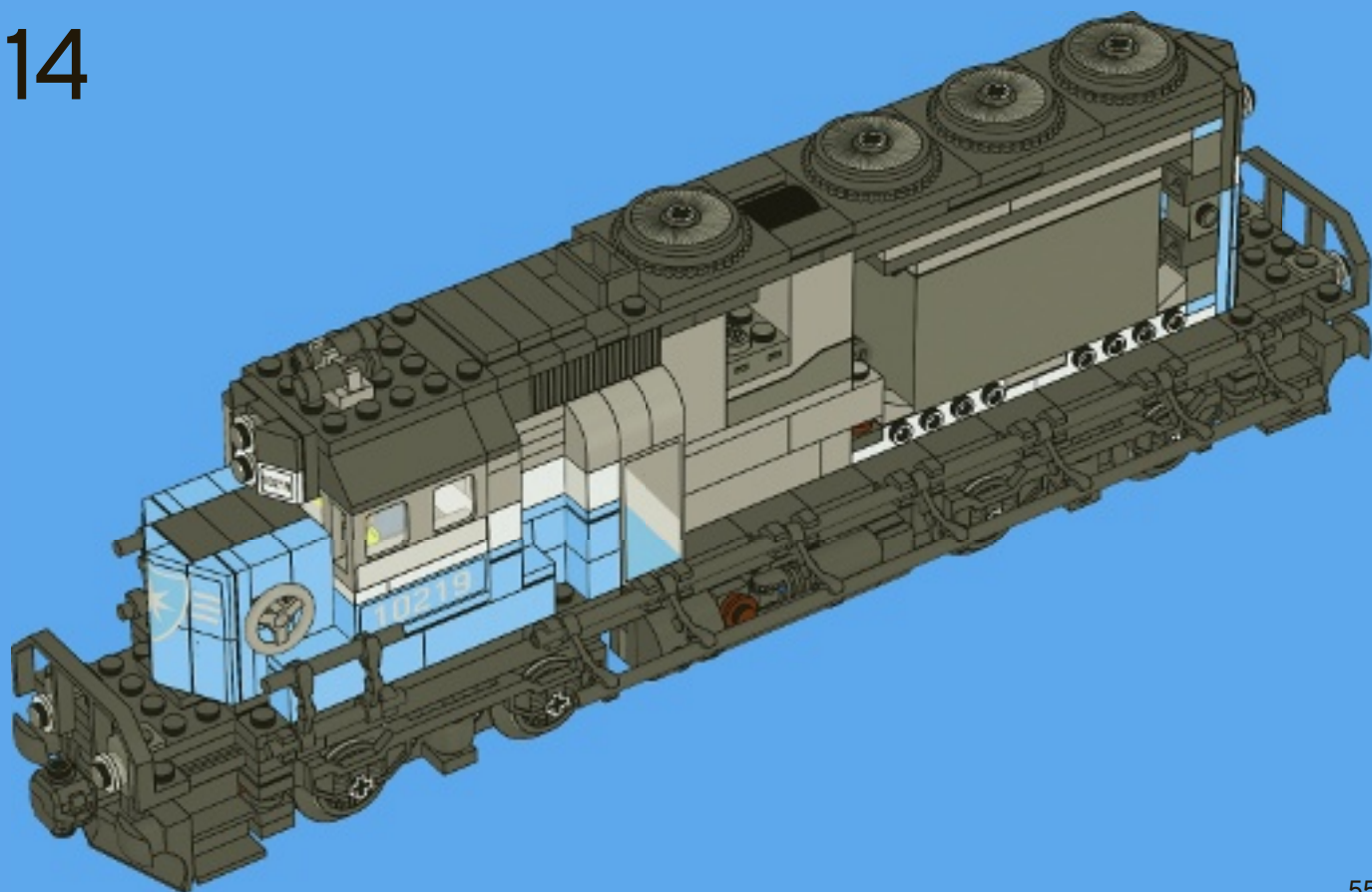

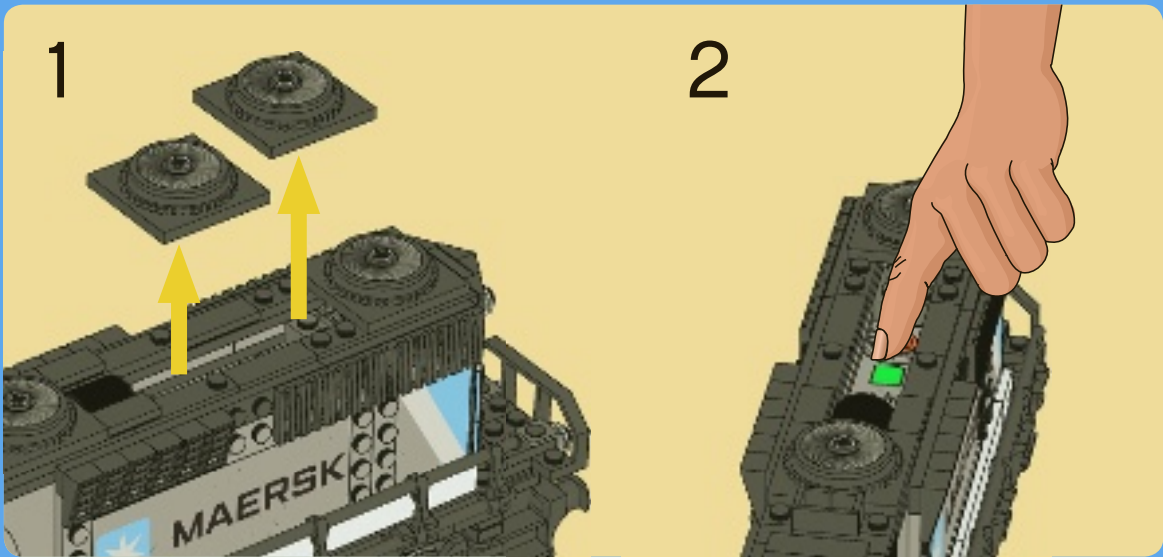
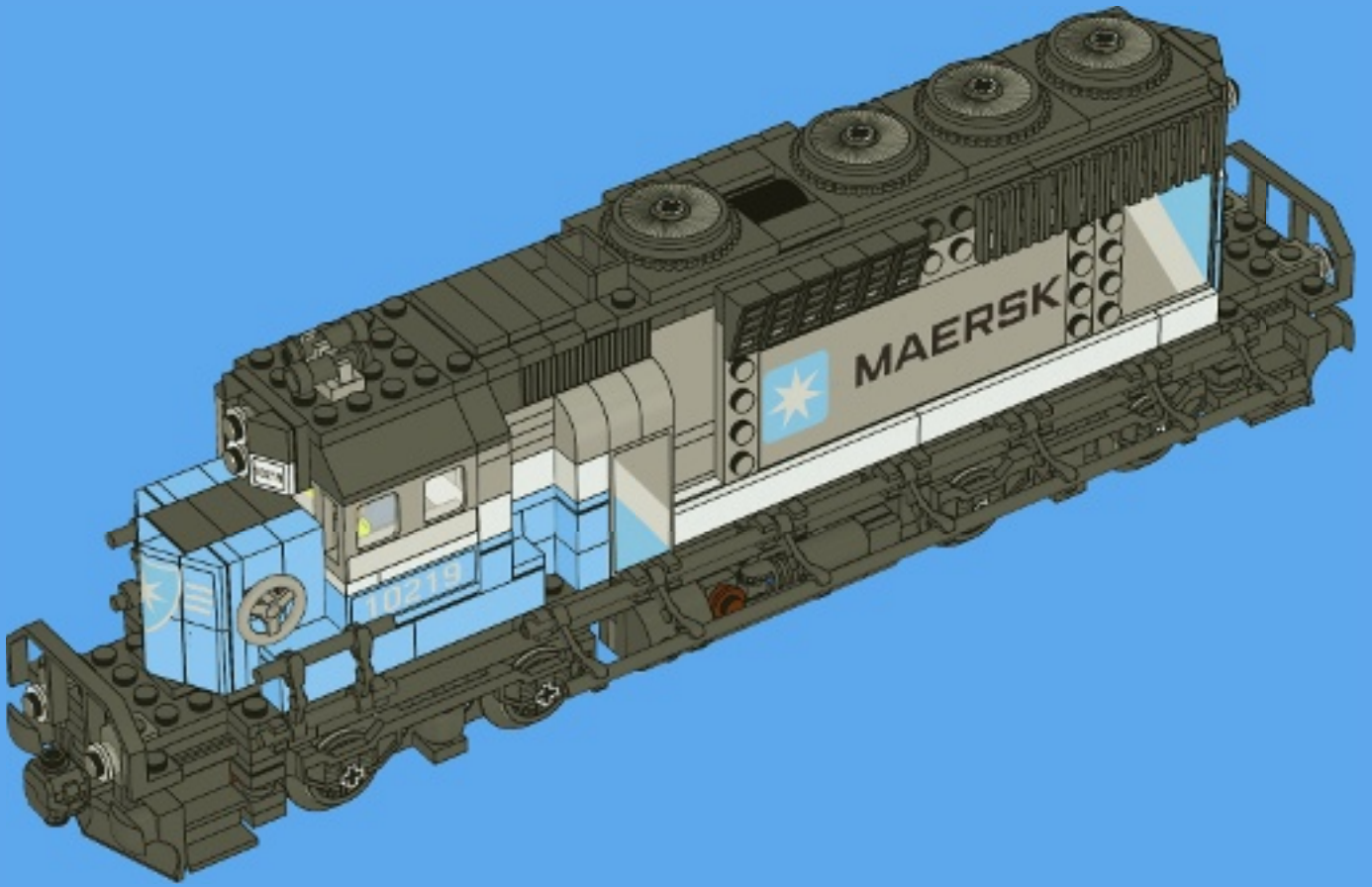

10194





10213





FREE! GRATIS! GRATUIT!

www.LEGOclub.com

LEGO Club Email

LEGO Club Magazine



VISIT THE WORLD'S BIGGEST LEGO SHOP!

www.LEGOshop.com

GO TO

www.LEGOclub.com

00800 5346 5555



1-866-534-6258 • 1-877-518-5346

US & Canada only

Canada seulement



* Freephone. Mobile charges may apply. * Numéro sans frais. Des frais peuvent s'appliquer avec les téléphones cellulaires. * Gebührenfrei. Kosten für Anrufe aus Mobilfunknetzen können abweichen. * Gratis telefonnummer vanaf vaste lijn. * Det er et gratis nummer, når du ringer fra fasttelefon. * Det är gratis, när du ringer från en fast telefon. * Numéro sans frais. Des frais peuvent s'appliquer avec les téléphones portables.

YES! I want to join the LEGO Club FREE! OUI! Je veux m'abonner au LEGO Club GRATUITEMENT! Ja! Ich möchte Mitglied im kostenlosen LEGO Club werden. Ja! Ik wil graag GRATIS lid worden van de LEGO Club. Ja! Jeg ønsker å melde meg inn i LEGO Club gratis! Ja! Jag vill gå med i LEGO Club GRATIS!

Registration form fields: First name, Last name, Date of Birth, Street, City, Zip/Postcode, Email.

Mail and postage information: Mail to, Per Post an, Stuur op naar, Send til, Skickas till, Poster à.

- Fill in your email address and we will send you a membership confirmation and monthly email newsletters. If you do not wish to receive additional mailings from the LEGO Club please tick here.

The English language version of the magazine can only be mailed to addresses in the US, Canada, the UK, and Republic of Ireland. Club membership is valid for two years and includes free copies of the LEGO Club Magazine and e-mail newsletters.

Parent's signature - Signature d'un parent ou d'un tuteur - Unterschrift Erziehungsberechtigter / Handtekening ouders - Foreldres/foresattes underskrift / Förälders / förmyndares underskrift

Date Datum Date

B116



WIN!

Go to www.LEGOsurvey.com/product to fill out a survey for a chance to win a cool LEGO® Product. No purchase necessary. Open to all residents where not prohibited.

 www.LEGO.com



www.LEGOsurvey.com/product

GEWINNE!

Nimm an der Umfrage auf www.LEGOsurvey.com/product teil und hab die Chance ein cooles LEGO® Produkt zu gewinnen! Die Teilnahme am Gewinnspiel führt zu keinerlei Kaufverpflichtungen. Teilnahme in allen nicht ausgeschlossenen Ländern möglich.

4632677

WIN!

Ga naar www.LEGOsurvey.com/product, vul een enquêteformulier in en maak kans op een cool LEGO® product.

Geen aankoopverplichting. Iedereen mag deelnemen, uitgezonderd ingezetenden van landen waar een enquêteverbod geldt.

GAGNE!











Visite www.LEGOsurvey.com/product pour répondre à un questionnaire et avoir une chance de gagner un produit LEGO® très cool!

Aucune obligation d'achat. Ouvert à tous les résidents des pays autorisés.

当てよう!

www.LEGOsurvey.com/product にアクセスして、アンケートにご記入ください。当選者にはレゴ製品を差し上げます。



お買い上げの必要はありません。禁止されていない限り、すべての皆様にご利用いただけます。

Image	Qty	Item No	Description	MID
Regular Items:				
Parts:				
	18	30377	Black Arm Mechanical, Battle Droid Catalog: Parts: Minifigure, Body Part 4223247	PG
	4	30374	Black Bar 4L (Lightsaber Blade / Wand) Catalog: Parts: Bar 6116604 or 3037426 or 4140303	PG
	2	30374	Light Bluish Gray Bar 4L (Lightsaber Blade / Wand) Catalog: Parts: Bar 6116608 or 4211628	PG
	2	63965	Black Bar 6L with Stop Ring Catalog: Parts: Bar 6170421 or 4533907 or 6081988 or 6061538 or 4613957 or 4538722	PG
	1	6187	Black Bar 1 x 4 x 2 Catalog: Parts: Bar 4141349	PG
	1	58176	Trans-Orange Bar with Light Cover / Bionicle Barraki Eye Catalog: Parts: Bar 6171764 or 4524365	PG
	2	2436	Light Bluish Gray Bracket 1 x 2 - 1 x 4 Catalog: Parts: Bracket 4211358 or 4282740	PG
	26	44728	Dark Bluish Gray Bracket 1 x 2 - 2 x 2 Catalog: Parts: Bracket 6117972 or 6048854 or 4210893 or 4277928	PG
	4	44728	Light Bluish Gray Bracket 1 x 2 - 2 x 2 Catalog: Parts: Bracket 6117967 or 6009014 or 4211811 or 4277927	PG
	13	3956	Light Bluish Gray Bracket 2 x 2 - 2 x 2 with 2 Holes Catalog: Parts: Bracket 6254807 or 6019212 or 4211472	PG
	2	6087	Black Bracket 5 x 2 x 2 1/3 with 2 Holes Catalog: Parts: Bracket 608726 or 4100423	PG

+		4	3005	Black Brick 1 x 1 Catalog: Parts: Brick 300526	PG
---	--	---	----------------------	---	--------------------

+		3	3005	Light Bluish Gray Brick 1 x 1 Catalog: Parts: Brick 4211389	PG
---	---	---	----------------------	--	--------------------

+		11	3005	Maersk Blue Brick 1 x 1 Catalog: Parts: Brick 4585671	PG
---	---	----	----------------------	--	--------------------

+		4	2453a	Light Bluish Gray Brick 1 x 1 x 5 - Blocked Open Stud or Hollow Stud Catalog: Parts: Brick 4211362	PG 1 
---	---	---	-----------------------	---	--

+		2	2453a	White Brick 1 x 1 x 5 - Blocked Open Stud or Hollow Stud Catalog: Parts: Brick 245301	PG
---	---	---	-----------------------	--	--------------------

+		10	3004	Maersk Blue Brick 1 x 2 Catalog: Parts: Brick 4585673	PG
---	--	----	----------------------	--	--------------------

+		2	3622	Light Bluish Gray Brick 1 x 3 Catalog: Parts: Brick 4211428	PG
---	---	---	----------------------	--	--------------------













+		4	3010	Light Bluish Gray Brick 1 x 4 Catalog: Parts: Brick 4211394	PG
---	---	---	----------------------	--	--------------------

+		13	3010	Maersk Blue Brick 1 x 4 Catalog: Parts: Brick 4585667	PG
---	---	----	----------------------	--	--------------------

+		5	3009	Light Bluish Gray Brick 1 x 6 Catalog: Parts: Brick 4211393	PG
---	---	---	----------------------	--	--------------------

+		2	3009	White Brick 1 x 6 Catalog: Parts: Brick 300901	PG
---	---	---	----------------------	---	--------------------

+		12	6112	Light Bluish Gray Brick 1 x 12 Catalog: Parts: Brick 4211522	PG
---	---	----	----------------------	---	--------------------

+		6	6112	White Brick 1 x 12 Catalog: Parts: Brick 611201	PG
	*				
+		1	3003	Black Brick 2 x 2 Catalog: Parts: Brick 300326	PG
	*				
+		6	3003	Maersk Blue Brick 2 x 2 Catalog: Parts: Brick 4585678	PG
	*				
+		3	2357	Maersk Blue Brick 2 x 2 Corner Catalog: Parts: Brick 4585675	PG
	*				
+		1	3001	Black Brick 2 x 4 Catalog: Parts: Brick 300126	PG
	*				
+		5	3001	Maersk Blue Brick 2 x 4 Catalog: Parts: Brick 4250614 or 4585679	PG
	*				
+		1	2456	Light Bluish Gray Brick 2 x 6 Catalog: Parts: Brick 4211795	PG
	*				
+		1	60476	Light Bluish Gray Brick, Modified 1 x 1 with Clip Horizontal Catalog: Parts: Brick, Modified 4535764	PG
	*				
+		1	30241	White Brick, Modified 1 x 1 with Clip Vertical Catalog: Parts: Brick, Modified 4533763 or 4515352	PG
	*				2 
+		5	4070	Black Brick, Modified 1 x 1 with Headlight Catalog: Parts: Brick, Modified 407026	PG
	*				
+		12	87087	Dark Bluish Gray Brick, Modified 1 x 1 with Stud on 1 Side Catalog: Parts: Brick, Modified 4558955	PG
	*				
+		2	60583b	White Brick, Modified 1 x 1 x 3 with 2 Clips Vertical - Hollow Stud Catalog: Parts: Brick, Modified 4563684	PG
	*				

+		6	2877	Black Brick, Modified 1 x 2 with Grille (Flutes)	PG
	*			Catalog: Parts: Brick, Modified 287726	
+		89	4216	Light Bluish Gray Brick, Modified 1 x 2 with Groove	PG
	*			Catalog: Parts: Brick, Modified 4617170 or 4541224	
+		28	4216	White Brick, Modified 1 x 2 with Groove	PG
	*			Catalog: Parts: Brick, Modified 4264360	
+		1	52107	Red Brick, Modified 1 x 2 with Studs on 2 Sides	PG
	*			Catalog: Parts: Brick, Modified 4569056	
+		4	6091	Black Brick, Modified 1 x 2 x 1 1/3 with Curved Top	PG
	*			Catalog: Parts: Brick, Modified 6184784 or 609126	
+		3	6091	Light Bluish Gray Brick, Modified 1 x 2 x 1 1/3 with Curved Top	PG
	*			Catalog: Parts: Brick, Modified 6285778 or 4211519	
+		2	88393	White Brick, Modified 1 x 2 x 5 with Groove	PG
	*			Catalog: Parts: Brick, Modified 4582155	
+		2	6191	Black Brick, Modified 1 x 4 x 1 1/3 No Studs, Curved Top	PG
	*			Catalog: Parts: Brick, Modified 6019726 or 4200031	
+		3	30165	Black Brick, Modified 2 x 2 Curved Top with 2 Top Studs	PG
	*			Catalog: Parts: Brick, Modified 4113231 or 4200023	
+		1	6232	Dark Bluish Gray Brick, Modified 2 x 2 with Pin and Axle Hole	PG
	*			Catalog: Parts: Brick, Modified 4211046	
+		5	30000	Light Bluish Gray Brick, Modified 2 x 2 with Pins and Axle Hole	PG
	*			Catalog: Parts: Brick, Modified 4211752	
+		2	47456	Reddish Brown Brick, Modified 2 x 3 x 2/3 Two Studs, Wing End	PG
	*			Catalog: Parts: Brick, Modified 4507833	

+



*

2

[87620](#)

White Brick, Modified Facet 2 x 2

[Catalog: Parts: Brick, Modified](#)
6137926 or 4560939

[PG](#)

+



*

5

[3062b](#)

Light Bluish Gray Brick, Round 1 x 1 Open Stud

[Catalog: Parts: Brick, Round](#)
4211412

[PG](#)

+



*

1

[3941](#)

Black Brick, Round 2 x 2 with Axle Hole

[Catalog: Parts: Brick, Round](#)
614326

[PG](#)

+



*

1

[87617](#)

Black Cylinder 1 x 5 1/2 with Handle (Friction Cylinder)

[Catalog: Parts: Cylinder](#)
6195916 or 4569407

[PG](#)

+



*

2

[58381](#)

Light Bluish Gray Door 1 x 3 x 4 Left - Open Between Top and Bottom Hinge

[Catalog: Parts: Door](#)
4617109

[PG](#)

+



*

1

[58381](#)

White Door 1 x 3 x 4 Left - Open Between Top and Bottom Hinge

[Catalog: Parts: Door](#)
4506668 or 4501778

[PG](#)

+



*

2

[58380](#)

Light Bluish Gray Door 1 x 3 x 4 Right - Open Between Top and Bottom Hinge

[Catalog: Parts: Door](#)
4617168

[PG](#)

+



*

1

[58380](#)

White Door 1 x 3 x 4 Right - Open Between Top and Bottom Hinge

[Catalog: Parts: Door](#)
4506667

[PG](#)

+



*

4

[2335](#)

Black Flag 2 x 2 Square

[Catalog: Parts: Flag](#)
6011815 or 4523405 or 233526

[PG](#)

+



*

6

[60601](#)

Trans-Clear Glass for Window 1 x 2 x 2 Flat Front

[Catalog: Parts: Glass](#)
6254552 or 4537946 or 4542078 or 6024020 or 4521209 or 4552035

[PG](#)

+



*

2

[30553](#)

Black Hinge Cylinder 1 x 2 Locking with 2 Fingers and Axle Hole on Ends

[Catalog: Parts: Hinge](#)
4143372

[PG](#)

+



*













2

[30383](#)

Black Hinge Plate 1 x 2 Locking with 1 Finger On Top

[Catalog: Parts: Hinge](#)
3038326 or 4142992 or 4144575

[PG](#)

+	 *	4	75c24	Black Hose, Rigid 3mm D. 24L / 19.2cm Catalog: Parts: Hose, Rigid 3mm D. 4581556	PG
+	 *	4	42446	Dark Bluish Gray Minifigure, Neck Bracket with Back Stud - Thin Back Wall Catalog: Parts: Minifigure, Body Wear 4210469	PG
+	 *	1	30162	Dark Bluish Gray Minifigure, Utensil Binoculars Town Catalog: Parts: Minifigure, Utensil 4587887 or 4211051	PG
+	 *	1	60849	Black Minifigure, Utensil Hose Nozzle Elaborate Catalog: Parts: Minifigure, Utensil 4537551	PG
+	 *	2	4079b	Dark Bluish Gray Minifigure, Utensil Seat (Chair) 2 x 2 with Center Sprue Mark Catalog: Parts: Minifigure, Utensil 4524930	PG
+	 *	2	64644	Black Minifigure, Utensil Telescope Catalog: Parts: Minifigure, Utensil 4538456	PG
+	 *	1	4006	Black Minifigure, Utensil Tool Spanner Wrench / Screwdriver Catalog: Parts: Minifigure, Utensil 4569095 or 400626	PG
+	 *	2	6231	Black Panel 1 x 1 x 1 Corner Catalog: Parts: Panel 4106347	PG
+	 *	9	4865b	Black Panel 1 x 2 x 1 with Rounded Corners Catalog: Parts: Panel 6146220 or 486526	PG
+	 *	6	4865b	Maersk Blue Panel 1 x 2 x 1 with Rounded Corners Catalog: Parts: Panel 4585687	PG
+	 *	2	87544	Light Bluish Gray Panel 1 x 2 x 3 with Side Supports - Hollow Studs Catalog: Parts: Panel 4585429	PG
+	 *	2	3024	Trans-Clear Plate 1 x 1 Catalog: Parts: Plate 6252041 or 3000840	PG

+		2	3024	Trans-Orange Plate 1 x 1 Catalog: Parts: Plate 6252040 or 4542673	PG
---	--	---	----------------------	--	--------------------

+		27	3023	Black Plate 1 x 2 Catalog: Parts: Plate 302326	PG
---	---	----	----------------------	---	--------------------

+		3	3023	Light Bluish Gray Plate 1 x 2 Catalog: Parts: Plate 3023194 or 4211398	PG
---	---	---	----------------------	---	--------------------

+		2	3023	Trans-Orange Plate 1 x 2 Catalog: Parts: Plate 6240217 or 4280341	PG
---	---	---	----------------------	--	--------------------

+		28	3023	White Plate 1 x 2 Catalog: Parts: Plate 302301	PG
---	---	----	----------------------	---	--------------------

+		2	3623	Black Plate 1 x 3 Catalog: Parts: Plate 362326	PG
---	--	---	----------------------	---	--------------------

+		5	3623	Light Bluish Gray Plate 1 x 3 Catalog: Parts: Plate 4211429 or 3623194	PG
---	---	---	----------------------	---	--------------------

+		2	3623	White Plate 1 x 3 Catalog: Parts: Plate 362301	PG
---	---	---	----------------------	---	--------------------

+		6	3710	Light Bluish Gray Plate 1 x 4 Catalog: Parts: Plate 4211445	PG
---	---	---	----------------------	--	--------------------

+		16	3710	Maersk Blue Plate 1 x 4 Catalog: Parts: Plate 4616411	PG
---	---	----	----------------------	--	--------------------

+		4	3710	Reddish Brown Plate 1 x 4 Catalog: Parts: Plate 4211190	PG
---	---	---	----------------------	--	--------------------

+		11	3666	Black Plate 1 x 6 Catalog: Parts: Plate 366626	PG
---	---	----	----------------------	---	--------------------

+		10	3666	Light Bluish Gray Plate 1 x 6 Catalog: Parts: Plate 4211438	PG
---	--	----	----------------------	--	--------------------

+		1	3666	White Plate 1 x 6 Catalog: Parts: Plate 366601	PG
---	---	---	----------------------	---	--------------------

+		4	3460	Dark Bluish Gray Plate 1 x 8 Catalog: Parts: Plate 4210998	PG
---	---	---	----------------------	---	--------------------

+		4	4477	Black Plate 1 x 10 Catalog: Parts: Plate 447726	PG
---	---	---	----------------------	--	--------------------

+		2	60479	Black Plate 1 x 12 Catalog: Parts: Plate 4514845	PG
---	---	---	-----------------------	---	--------------------

+		14	3022	Black Plate 2 x 2 Catalog: Parts: Plate 302226	PG
---	---	----	----------------------	---	--------------------

+		12	3022	Light Bluish Gray Plate 2 x 2 Catalog: Parts: Plate 4211397	PG
---	---	----	----------------------	--	--------------------

+		17	3022	Maersk Blue Plate 2 x 2 Catalog: Parts: Plate 4585677	PG
---	---	----	----------------------	--	--------------------

+		13	2420	Light Bluish Gray Plate 2 x 2 Corner Catalog: Parts: Plate 4211353	PG
---	---	----	----------------------	---	--------------------

+		8	3021	Black Plate 2 x 3 Catalog: Parts: Plate 302126	PG
---	---	---	----------------------	---	--------------------

+		24	3020	Maersk Blue Plate 2 x 4 Catalog: Parts: Plate 4585664	PG
---	---	----	----------------------	--	--------------------

+		5	3795	Black Plate 2 x 6 Catalog: Parts: Plate 379526	PG
---	---	---	----------------------	---	--------------------

+		7	3795	White Plate 2 x 6 Catalog: Parts: Plate 379501	PG
	*				
+		1	3832	Black Plate 2 x 10 Catalog: Parts: Plate 383226	PG
	*				
+		1	3031	Black Plate 4 x 4 Catalog: Parts: Plate 303126 or 4243819	PG
	*				
+		1	3031	Light Bluish Gray Plate 4 x 4 Catalog: Parts: Plate 4211403 or 4243797	PG
	*				
+		2	3032	Black Plate 4 x 6 Catalog: Parts: Plate 303226	PG
	*				
+		1	3035	Black Plate 4 x 8 Catalog: Parts: Plate 303526	PG
	*				
+		2	3030	Black Plate 4 x 10 Catalog: Parts: Plate 303026	PG
	*				
+		6	3027	Light Bluish Gray Plate 6 x 16 Catalog: Parts: Plate 4211733	PG
	*				
+		8	61252	Black Plate, Modified 1 x 1 with Clip Horizontal (thick open O clip) Catalog: Parts: Plate, Modified 4517925	PG
	*				
+		2	4085d	Light Bluish Gray Plate, Modified 1 x 1 with Clip Vertical - Type 4 (thick open O clip) Catalog: Parts: Plate, Modified 6296894 or 4613956 or 4594238	PG 3 
	*				
+		6	3794a	Black Plate, Modified 1 x 2 with 1 Stud without Groove (Jumper) Catalog: Parts: Plate, Modified 379426	PG 4 
	*				
+		3	3794a	Light Bluish Gray Plate, Modified 1 x 2 with 1 Stud without Groove (Jumper) Catalog: Parts: Plate, Modified 4211451	PG
	*				

+	 *	2	3794a	White Plate, Modified 1 x 2 with 1 Stud without Groove (Jumper) Catalog: Parts: Plate, Modified 379401	PG
+	 *	4	63868	Black Plate, Modified 1 x 2 with Clip Horizontal on End Catalog: Parts: Plate, Modified 4535739	PG
+	 *	9	32028	Black Plate, Modified 1 x 2 with Door Rail Catalog: Parts: Plate, Modified 4107761	PG
+	 *	4	32028	Light Bluish Gray Plate, Modified 1 x 2 with Door Rail Catalog: Parts: Plate, Modified 4211568	PG
+	 *	1	4175	Dark Bluish Gray Plate, Modified 1 x 2 with Ladder Catalog: Parts: Plate, Modified 6285244 or 6179567 or 4603504 or 4210801	PG
+	 *	1	4590	Dark Bluish Gray Plate, Modified 1 x 4 Offset Catalog: Parts: Plate, Modified 6086709 or 4217558	PG
+	 *	10	92593	Black Plate, Modified 1 x 4 with 2 Studs without Groove Catalog: Parts: Plate, Modified 4599499	PG
+	 *	1	30043	Light Bluish Gray Plate, Modified 1 x 4 with Arm Down Catalog: Parts: Plate, Modified 6173095 or 4261605	PG
+	 *	2	6583	Black Plate, Modified 1 x 6 with Train Wagon End Catalog: Parts: Plate, Modified 658326	PG
+	 *	4	4510	Dark Bluish Gray Plate, Modified 1 x 8 with Door Rail Catalog: Parts: Plate, Modified 4210967	PG
+	 *	8	4510	Light Bluish Gray Plate, Modified 1 x 8 with Door Rail Catalog: Parts: Plate, Modified 4211498	PG
+	 *	4	41862	Light Bluish Gray Plate, Modified 2 x 2 with Grills Catalog: Parts: Plate, Modified 4211748	PG

+	 *	8	4488	Black Plate, Modified 2 x 2 with Wheel Holder Catalog: Parts: Plate, Modified 6092658 or 448826	PG
---	---	---	----------------------	--	--------------------

+	 *	6	87609	White Plate, Modified 2 x 6 x 2/3 with 4 Studs on Side Catalog: Parts: Plate, Modified 4560929	PG
---	--	---	-----------------------	---	--------------------

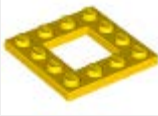
+	 *	1	64799	Yellow Plate, Modified 4 x 4 with 2 x 2 Cutout Catalog: Parts: Plate, Modified 4549896	PG
---	--	---	-----------------------	---	--------------------

+	 *	5	4073	Black Plate, Round 1 x 1 Catalog: Parts: Plate, Round 614126	PG
---	--	---	----------------------	---	--------------------

+	 *	4	4073	Reddish Brown Plate, Round 1 x 1 Catalog: Parts: Plate, Round 4216581	PG
---	--	---	----------------------	--	--------------------

+	 *	8	4073	Trans-Clear Plate, Round 1 x 1 Catalog: Parts: Plate, Round 6240030 or 3005740	PG
---	---	---	----------------------	---	--------------------

+	 *	4	4073	Trans-Red Plate, Round 1 x 1 Catalog: Parts: Plate, Round 6208450 or 3005741	PG
---	--	---	----------------------	---	--------------------

+	 *	4	4032	Light Bluish Gray Plate, Round 2 x 2 with Axle Hole Catalog: Parts: Plate, Round 4211475	PG
---	--	---	----------------------	---	--------------------

+	 *	2	30357	White Plate, Round Corner 3 x 3 Catalog: Parts: Plate, Round 4550745	PG
---	--	---	-----------------------	---	--------------------

+	 *	13	61409	Black Slope 18 2 x 1 x 2/3 with 4 Slots Catalog: Parts: Slope 4541191	PG
---	--	----	-----------------------	--	--------------------

+	 *	5	54200	Black Slope 30 1 x 1 x 2/3 Catalog: Parts: Slope 4287159 or 4504382	PG
---	--	---	-----------------------	--	--------------------

+	 *	12	54200	Light Bluish Gray Slope 30 1 x 1 x 2/3 Catalog: Parts: Slope 4521921	PG
---	--	----	-----------------------	---	--------------------

+		7	54200	White Slope 30 1 x 1 x 2/3 Catalog: Parts: Slope 4244370 or 4504369	PG
---	--	---	-----------------------	--	--------------------

+		2	85984	Black Slope 30 1 x 2 x 2/3 Catalog: Parts: Slope 4548180	PG
---	---	---	-----------------------	---	--------------------

+		24	85984	Maersk Blue Slope 30 1 x 2 x 2/3 Catalog: Parts: Slope 4616412	PG
---	---	----	-----------------------	---	--------------------

+		2	3040	Black Slope 45 2 x 1 Catalog: Parts: Slope 304026 or 4121966	PG
---	---	---	----------------------	---	--------------------

+		2	92946	Red Slope 45 2 x 1 with 2/3 Cutout Catalog: Parts: Slope 6053011 or 4603263	PG
---	---	---	-----------------------	--	--------------------

+		1	3039	White Slope 45 2 x 2 Catalog: Parts: Slope 303901	PG
---	---	---	----------------------	--	--------------------

+		2	3037	Black Slope 45 2 x 4 Catalog: Parts: Slope 303726	PG
---	---	---	----------------------	--	--------------------













+		1	3747b	Maersk Blue Slope, Inverted 33 3 x 2 with Connections between Studs Catalog: Parts: Slope, Inverted 4585682	PG
---	---	---	-----------------------	--	--------------------











+		2	3660	Maersk Blue Slope, Inverted 45 2 x 2 Catalog: Parts: Slope, Inverted 4585681	PG
---	---	---	----------------------	---	--------------------



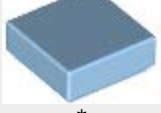

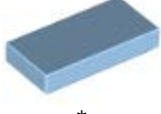







+		1	10219stk01	Sticker for Set 10219 - (94765/4616559) Catalog: Parts: Sticker 4616559	PG
---	---	---	----------------------------	--	--------------------









+		3	3713	Light Bluish Gray Technic Bush Catalog: Parts: Technic 6275844 or 4211622	PG
---	---	---	----------------------	--	--------------------











+		4	4265c	Light Bluish Gray Technic Bush 1/2 Smooth Catalog: Parts: Technic 6271165 or 4211573	PG
---	---	---	-----------------------	---	--------------------

+	 *	4	32062	Black Technic, Axle 2 Notched Catalog: Parts: Technic, Axle 3206226 or 4109810	PG
+	 *	2	87083	Dark Bluish Gray Technic, Axle 4 with Stop Catalog: Parts: Technic, Axle 6083620 or 4560177	PG
+	 *	4	3706	Black Technic, Axle 6 Catalog: Parts: Technic, Axle 370626	PG
+	 *	4	43093	Blue Technic, Axle Pin with Friction Ridges Lengthwise Catalog: Parts: Technic, Axle 4309323 or 4206482	PG
+	 *	2	6541	White Technic, Brick 1 x 1 with Hole Catalog: Parts: Technic, Brick 65411 or 654101	PG
+	 *	2	3702	Black Technic, Brick 1 x 8 with Holes Catalog: Parts: Technic, Brick 370226	PG
+	 *	6	2730	Black Technic, Brick 1 x 10 with Holes Catalog: Parts: Technic, Brick 273026	PG
+	 *	4	2958	Black Technic, Disk 3 x 3 Catalog: Parts: Technic, Disk 4218868	PG
+	 *	2	2825	Black Technic, Liftarm 1 x 4 Thin with Stud Connector Catalog: Parts: Technic, Liftarm 3200626 or 4107136	PG
+	 *	8	4274	Light Bluish Gray Technic, Pin 1/2 Catalog: Parts: Technic, Pin 4211483 or 4274194	PG
+	 *	8	32530	Dark Bluish Gray Technic, Pin Connector Plate 1 x 2 x 1 2/3 with 2 Holes (Double on Top) Catalog: Parts: Technic, Connector 4210763	PG
+	 *	6	62462	Black Technic, Pin Connector Round 2L with Slot (Pin Joiner Round) Catalog: Parts: Technic, Connector 6173119 or 4526982	PG

+		7	2780	Black Technic, Pin with Friction Ridges Lengthwise WITH Center Slots Catalog: Parts: Technic, Pin 4121715 or 278026	PG
+		8	3673	Light Bluish Gray Technic, Pin without Friction Ridges Lengthwise Catalog: Parts: Technic, Pin 3673194 or 4211807	PG
+		9	3709b	Black Technic, Plate 2 x 4 with 3 Holes Catalog: Parts: Technic, Plate 370926	PG
+		4	3070b	Black Tile 1 x 1 with Groove (3070) Catalog: Parts: Tile 307026	PG
+		16	3070b	Maersk Blue Tile 1 x 1 with Groove (3070) Catalog: Parts: Tile 4585684	PG
+		2	3070bp07	Light Bluish Gray Tile 1 x 1 with Groove with White and Red Gauge Pattern Catalog: Parts: Tile, Decorated 4255629	PG
+		21	3069b	Black Tile 1 x 2 with Groove Catalog: Parts: Tile 306926	PG
+		24	3069b	Maersk Blue Tile 1 x 2 with Groove Catalog: Parts: Tile 4585669	PG
+		4	3069b	White Tile 1 x 2 with Groove Catalog: Parts: Tile 306901	PG
+		9	63864	Black Tile 1 x 3 Catalog: Parts: Tile 4558170	PG
+		16	2431	Maersk Blue Tile 1 x 4 Catalog: Parts: Tile 4250597 or 4585663	PG
+		1	2431px17	Dark Bluish Gray Tile 1 x 4 with Light Switch, 2 White Gauges and Train Throttle Pattern Catalog: Parts: Tile, Decorated 6020825 or 4215740	PG

+	 *	15	6636	Maersk Blue Tile 1 x 6 Catalog: Parts: Tile 4250620 or 4585685	PG
+	 *	20	4162	Maersk Blue Tile 1 x 8 Catalog: Parts: Tile 4585686	PG
+	 *	4	4162	White Tile 1 x 8 Catalog: Parts: Tile 416201	PG
+	 *	6	87079	Light Bluish Gray Tile 2 x 4 Catalog: Parts: Tile 4560183	PG
+	 *	1	87079	White Tile 2 x 4 Catalog: Parts: Tile 4560178	PG
+	 *	2	2555	Light Bluish Gray Tile, Modified 1 x 1 with Clip Catalog: Parts: Tile, Modified 6030711 or 2555194 or 4211369	PG
+	 *	19	2412b	Black Tile, Modified 1 x 2 Grille with Bottom Groove / Lip Catalog: Parts: Tile, Modified 241226	PG
+	 *	17	2412b	Light Bluish Gray Tile, Modified 1 x 2 Grille with Bottom Groove / Lip Catalog: Parts: Tile, Modified 4211350	PG
+	 *	10	2432	Black Tile, Modified 1 x 2 with Handle Catalog: Parts: Tile, Modified 243226	PG
+	 *	10	30350c	Black Tile, Modified 2 x 3 with 2 Clips (thick U clips) Catalog: Parts: Tile, Modified 4297713	PG
+	 *	1	6179	Black Tile, Modified 4 x 4 with Studs on Edge Catalog: Parts: Tile, Modified 617926	PG
+	 *	2	6180	Light Bluish Gray Tile, Modified 4 x 6 with Studs on Edges Catalog: Parts: Tile, Modified 4211838	PG

+		2	6178	Light Bluish Gray Tile, Modified 6 x 12 with Studs on Edges Catalog: Parts: Tile, Modified 4211836	PG
*					
+		1	4150ps4	Light Bluish Gray Tile, Round 2 x 2 with Grille Fine Mesh Pattern Catalog: Parts: Tile, Round, Decorated 4221881	PG
*					
+		8	87697	Black Tire 21mm D. x 12mm - Offset Tread Small Wide, Band Around Center of Tread Catalog: Parts: Tire & Tread 4568644	PG
*					5
+		1	92339	Black Train Base 6 x 28 with 2 Square Cutouts and 3 Round Holes Each End Catalog: Parts: Train 4616992	PG
*					
+		2	87058	Light Bluish Gray Train Base 6 x 34 Split-Level without Bottom Tubes Catalog: Parts: Train 4616995	PG
*					
+		6	4025	Black Train Bogie Plate (Tile, Modified 6 x 4 with 5mm Pin) Catalog: Parts: Train 6096842 or 6051914 or 402526	PG
*					
+		4	91968c01	Black Train Buffer Beam with Sealed Magnets - Type 2 (flat open bottom) Catalog: Parts: Train 6125770 or 4589495	PG
*					
+		2	64415c01	Black Train Buffer Beam with Sealed Magnets and Plow Catalog: Parts: Train 6172142 or 6125768 or 4589489 or 4537293	PG
*					
+		4	2871b	Black Train Motor 9V Decorative Side with OPEN hub points (for RC Train motor) Catalog: Parts: Train 4493326	PG
*					
+		16	57878	Black Train Wheel RC Train Catalog: Parts: Wheel 4496343	PG
*					
+		8	2878	Black Train Wheel RC Train, Holder Catalog: Parts: Wheel 287826	PG
*					
+		8	x1687	Chrome Silver Train Wheel RC Train, Metal Axle Catalog: Parts: Wheel, Accessory 4298979	PG
*					

+	 *	8	55423c01	Black Train Wheel RC Train, Spoked with Technic Axle Hole and Rubber Friction Band Catalog: Parts: Wheel 4621116 or 4582034 or 4289864	PG
+	 *	4	61485	Black Turntable 4 x 4 Square Base, Locking Catalog: Parts: Turntable 4517986	PG
+	 *	8	50745	Black Vehicle, Mudguard 4 x 2 1/2 x 1 2/3 with Arch Round Catalog: Parts: Vehicle, Mudguard 4260488	PG
+	 *	1	3829c01	Light Bluish Gray Vehicle, Steering Stand 1 x 2 with Black Steering Wheel Catalog: Parts: Vehicle 4226995	PG
+	 *	3	30663	Light Bluish Gray Vehicle, Steering Wheel Small, 2 Studs Diameter Catalog: Parts: Vehicle 6092956 or 30663194 or 4211701	PG
+	 *	1	45677	White Wedge 4 x 4 x 2/3 Triple Curved Catalog: Parts: Wedge 456771 or 4193068	PG
+	 *	1	32059	Black Wedge, Plate 4 x 6 Cut Corners Catalog: Parts: Wedge, Plate 4129572	PG
+	 *	8	6014b	Light Bluish Gray Wheel 11mm D. x 12mm, Hole Notched for Wheels Holder Pin Catalog: Parts: Wheel 4211764	PG
+	 *	1	42610	Light Bluish Gray Wheel 11mm D. x 8mm with Center Groove Catalog: Parts: Wheel 4211758	PG
+	 *	3	61345	Light Bluish Gray Window 1 x 4 x 2 Plane, Single Hole Top and Bottom for Glass Catalog: Parts: Window 6115443 or 4617152	PG
+	 *	1	84954	Trans-Black Windscreen 3 x 4 x 3 Catalog: Parts: Windscreen 6244759 or 4543458	PG

Minifigs:

+		1	trn149(inv)	Maersk Train Workman 1 - Gray Beard	PG
---	--	---	-----------------------------	--	--------------------



*

[Catalog: Minifigs: Train](#)

+



*

1 [trn150\(inv\)](#) **Maersk Train Workman 2 - Silver Sunglasses**

[Catalog: Minifigs: Train](#)

[PG](#)

+



*

1 [trn151\(inv\)](#) **Maersk Train Workman 3 - Smile and White Glasses**

[Catalog: Minifigs: Train](#)

[PG](#)

Extra Items:

Parts:

+



*

2 [30377](#) **Black Arm Mechanical, Battle Droid**

[Catalog: Parts: Minifigure, Body Part](#)
4223247

[PG](#)

+



*

1 [32028](#) **Black Plate, Modified 1 x 2 with Door Rail**

[Catalog: Parts: Plate, Modified](#)
4107761

[PG](#)

+



*

2 [4073](#) **Black Plate, Round 1 x 1**

[Catalog: Parts: Plate, Round](#)
614126

[PG](#)

+



*

2 [4073](#) **Reddish Brown Plate, Round 1 x 1**

[Catalog: Parts: Plate, Round](#)
4216581

[PG](#)

+



*

2 [4073](#) **Trans-Clear Plate, Round 1 x 1**

[Catalog: Parts: Plate, Round](#)
6240030 or 3005740

[PG](#)

+



*

2 [4073](#) **Trans-Red Plate, Round 1 x 1**

[Catalog: Parts: Plate, Round](#)
6208450 or 3005741

[PG](#)

+



*

2 [54200](#) **Black Slope 30 1 x 1 x 2/3**

[Catalog: Parts: Slope](#)
4287159 or 4504382

[PG](#)

+

4 [54200](#) **Light Bluish Gray Slope 30 1 x 1 x 2/3**

[Catalog: Parts: Slope](#)

[PG](#)



*

4521921

+



*

3

[54200](#)**White Slope 30 1 x 1 x 2/3**Catalog: [Parts: Slope](#)
4244370 or 4504369[PG](#)

+



*

1

[3713](#)**Light Bluish Gray Technic Bush**Catalog: [Parts: Technic](#)
6275844 or 4211622[PG](#)

+



*

1

[4265c](#)**Light Bluish Gray Technic Bush 1/2 Smooth**Catalog: [Parts: Technic](#)
6271165 or 4211573[PG](#)

+



*

3

[4274](#)**Light Bluish Gray Technic, Pin 1/2**Catalog: [Parts: Technic, Pin](#)
4211483 or 4274194[PG](#)

+



*

3

[2780](#)**Black Technic, Pin with Friction Ridges Lengthwise WITH Center Slots**Catalog: [Parts: Technic, Pin](#)
4121715 or 278026[PG](#)

+



*

2

[3673](#)**Light Bluish Gray Technic, Pin without Friction Ridges Lengthwise**Catalog: [Parts: Technic, Pin](#)
3673194 or 4211807[PG](#)

+



*

1

[3070b](#)**Black Tile 1 x 1 with Groove (3070)**Catalog: [Parts: Tile](#)
307026[PG](#)

+

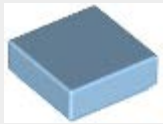

*

6

[3070b](#)**Maersk Blue Tile 1 x 1 with Groove (3070)**Catalog: [Parts: Tile](#)
4585684[PG](#)

+



*

1

[3070bp07](#)**Light Bluish Gray Tile 1 x 1 with Groove with White and Red Gauge Pattern**Catalog: [Parts: Tile, Decorated](#)
4255629[PG](#)**Counterparts:**

+

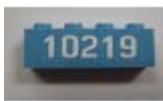

*

2

[3010pb134](#)**Maersk Blue Brick 1 x 4 with White '10219' Pattern (Sticker) - Set 10219**Catalog: [Parts: Brick, Decorated](#)
Part Color Code Missing[PG](#)

+

Light Bluish Gray Door 1 x 3 x 4 Left - Open Between Top and Bottom Hinge (New Type) with Maersk Logo Pattern (Sticker) - Set 10219

2

[58381pb02](#)[PG](#)



*

Catalog: [Parts: Door, Decorated](#)
Part Color Code Missing

+



*

1

[58381pb02](#)

White Door 1 x 3 x 4 Left - Open Between Top and Bottom Hinge (New Type) with Maersk Logo Pattern (Sticker) - Set 10219

Catalog: [Parts: Door, Decorated](#)
Part Color Code Missing

[PG](#)

+



*

2

[58380pb02](#)

Light Bluish Gray Door 1 x 3 x 4 Right - Open Between Top and Bottom Hinge (New Type) with Maersk Logo Pattern (Sticker) - Set 10219

Catalog: [Parts: Door, Decorated](#)
Part Color Code Missing

[PG](#)

+



*

1

[58380pb02](#)

White Door 1 x 3 x 4 Right - Open Between Top and Bottom Hinge (New Type) with Maersk Logo Pattern (Sticker) - Set 10219

Catalog: [Parts: Door, Decorated](#)
Part Color Code Missing

[PG](#)

+



*

4

[2335pb073](#)

Black Flag 2 x 2 Square with Maersk Logo Pattern (Sticker) - Set 10219

Catalog: [Parts: Flag, Decorated](#)
Part Color Code Missing

[PG](#)

+



*

2

[54200pb024L](#)

White Slope 30 1 x 1 x 2/3 with Black '10219' Pattern Left (Sticker) - Set 10219

Catalog: [Parts: Slope, Decorated](#)
Part Color Code Missing

[PG](#)

+



*

2

[54200pb024R](#)

White Slope 30 1 x 1 x 2/3 with Black '10219' Pattern Right (Sticker) - Set 10219

Catalog: [Parts: Slope, Decorated](#)
Part Color Code Missing

[PG](#)

+



*

4

[BA30pb01](#)

Light Bluish Gray Stickered Assembly 12 x 1 x 3 with Maersk Logo and 'MAERSK' Pattern (Sticker) - Set 10219 - 3 Bricks 1 x 12

Catalog: [Parts: Sticker Over Assembly](#)
Part Color Code Missing

[PG](#)

+



*

2

[BA30pb01](#)

White Stickered Assembly 12 x 1 x 3 with Maersk Logo and 'MAERSK' Pattern (Sticker) - Set 10219 - 3 Bricks 1 x 12

Catalog: [Parts: Sticker Over Assembly](#)
Part Color Code Missing

[PG](#)

+



*

4

[2958pb041](#)

Black Technic, Disk 3 x 3 with Black and Silver Mesh Pattern (Sticker) - Locomotive Fan

Catalog: [Parts: Technic, Disk](#)
Part Color Code Missing

[PG](#)

+



*

1

[3069bpb159](#)

White Tile 1 x 2 with Groove with 'APM 1904' Pattern (Sticker) - Set 10219

Catalog: [Parts: Tile, Decorated](#)
Part Color Code Missing

[PG](#)

+



*













1

[3069bpb160](#)

White Tile 1 x 2 with Groove with 'ML 1928' Pattern (Sticker) - Set 10219

Catalog: [Parts: Tile, Decorated](#)
Part Color Code Missing

[PG](#)

+		1	2431pb156	Maersk Blue Tile 1 x 4 with 'APM 1904' Pattern (Sticker) - Set 10219 Catalog: Parts: Tile_Decorated Part Color Code Missing	PG
+		4	4162pb060a	Maersk Blue Tile 1 x 8 with Maersk Logo and Large 'MAERSK' Pattern (Sticker) - Set 10219 Catalog: Parts: Tile_Decorated Part Color Code Missing	PG
+		2	4162pb060b	Maersk Blue Tile 1 x 8 with Maersk Logo and Small 'MAERSK' Pattern (Sticker) - Set 10219 Catalog: Parts: Tile_Decorated Part Color Code Missing	PG
+		1	87079pb027	White Tile 2 x 4 with Maersk Logo Pattern (Sticker) - Set 10219 Catalog: Parts: Tile_Decorated Part Color Code Missing	PG
+		1	87079pb028L	Light Bluish Gray Tile 2 x 4 with White Diagonal Stripe Left and Maersk Blue Pattern (Sticker) - Set 10219 Catalog: Parts: Tile_Decorated Part Color Code Missing	PG
+		1	87079pb028R	Light Bluish Gray Tile 2 x 4 with White Diagonal Stripe Right and Maersk Blue Pattern (Sticker) - Set 10219 Catalog: Parts: Tile_Decorated Part Color Code Missing	PG
+		1	6180pb040L	Light Bluish Gray Tile, Modified 4 x 6 with Studs on Edges with White Diagonal Stripe Left and Maersk Blue Pattern (Sticker) - Set 10219 Catalog: Parts: Tile_Modified_Decorated Part Color Code Missing	PG
+		1	6180pb040R	Light Bluish Gray Tile, Modified 4 x 6 with Studs on Edges with White Diagonal Stripe Right and Maersk Blue Pattern (Sticker) - Set 10219 Catalog: Parts: Tile_Modified_Decorated Part Color Code Missing	PG
+		2	6178pb006	Light Bluish Gray Tile, Modified 6 x 12 with Studs on Edges with 'MAERSK' and Maersk Logo Pattern (Sticker) - Set 10219 Catalog: Parts: Tile_Modified_Decorated Part Color Code Missing	PG
+		8	2878c02(inv)	Black Train Wheel RC Train, Holder with 2 Black Train Wheel RC Train and Chrome Silver Train Wheel RC Train, Metal Axle (2878 / 57878 / x1687) Catalog: Parts: Wheel Part Color Code Missing	PG
+		1	45677pb041	White Wedge 4 x 4 x 2/3 Triple Curved with Maersk Logo Pattern (Sticker) - Set 10219 Catalog: Parts: Wedge_Decorated Part Color Code Missing	PG
+		8	6014bc05(inv)	Light Bluish Gray Wheel 11mm D. x 12mm, Hole Notched for Wheels Holder Pin with Black Tire Offset Tread Small Wide, Band Around Center of Tread (6014b / 87697) Catalog: Parts: Wheel & Tire_Assembly Part Color Code Missing	PG



+  8 [6014bc03\(inv\)](#) **Light Bluish Gray Wheel 11mm D. x 12mm, Hole Notched for Wheels Holder Pin with Black Tire Offset Tread Small Wider, Beveled Tread Edge (6014b / 60700)** [PG](#)
 * [Catalog: Parts: Wheel & Tire Assembly](#)
 Part Color Code Missing

+  2 [61345pb01](#) **Light Bluish Gray Window 1 x 4 x 2 Plane, Single Hole Top and Bottom with White Stripe Pattern (Sticker) - Set 10219** [PG](#)
 * [Catalog: Parts: Window, Decorated](#)
 Part Color Code Missing



Alternate Items:

+  4 [2453b](#) **Light Bluish Gray Brick 1 x 1 x 5 - Solid Stud** [PG](#) 1 
 * [Catalog: Parts: Brick](#)
 4211362

+  1 [30241b](#) **White Brick, Modified 1 x 1 with Clip Vertical (open O clip) - Hollow Stud** [PG](#) 2 
 * [Catalog: Parts: Brick, Modified](#)
 4533763

+  1 [3626cpb0331](#) **Yellow Minifigure, Head Glasses with Gray Frame Sides, Brown Eyebrows and Open Smile Pattern - Hollow Stud** [PG](#) 6 
 * [Catalog: Parts: Minifigure, Head](#)
 4570663

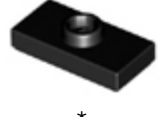
+  2 [4085b](#) **Light Bluish Gray Plate, Modified 1 x 1 with Clip Vertical - Type 2 (thin U clip)** [PG](#) 3 
 * [Catalog: Parts: Plate, Modified](#)
 4542317 or 4517961

+  6 [3794b](#) **Black Plate, Modified 1 x 2 with 1 Stud with Groove (Jumper)** [PG](#) 4 
 * [Catalog: Parts: Plate, Modified](#)
 379426

+  8 [60700](#) **Black Tire 21mm D. x 12mm - Offset Tread Small Wide, Beveled Tread Edge** [PG](#) 5 
 * [Catalog: Parts: Tire & Tread](#)
 4514560

Summary:

Type	Unique Lots	Total Qty
Regular Items:		
Parts	202	1218
Minifigs	3	3
Extra Items:		
Parts	17	38
Counterparts:		
Parts	27	69
Alternative Items:		
Parts	6	22

Source:

Sealed Set Contents

[ash_274 \(2444\)](#)  inventoried this Set on Apr 2, 2011, inventory last updated on Oct 6, 2019.