

# 8054

# Technic

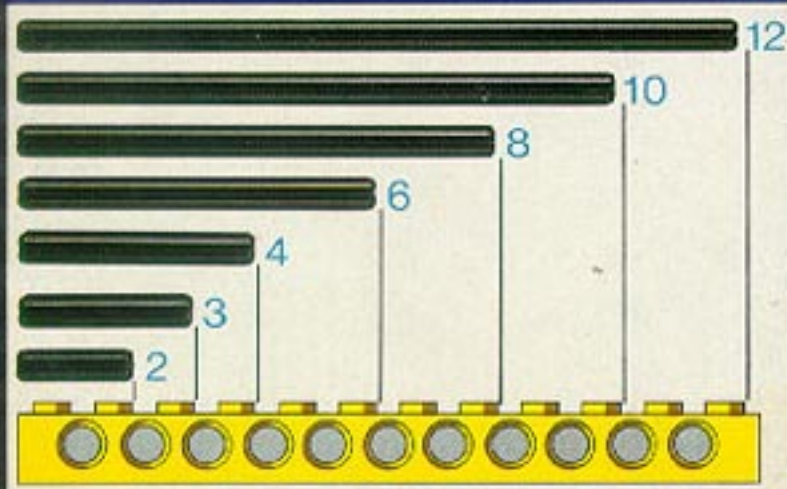
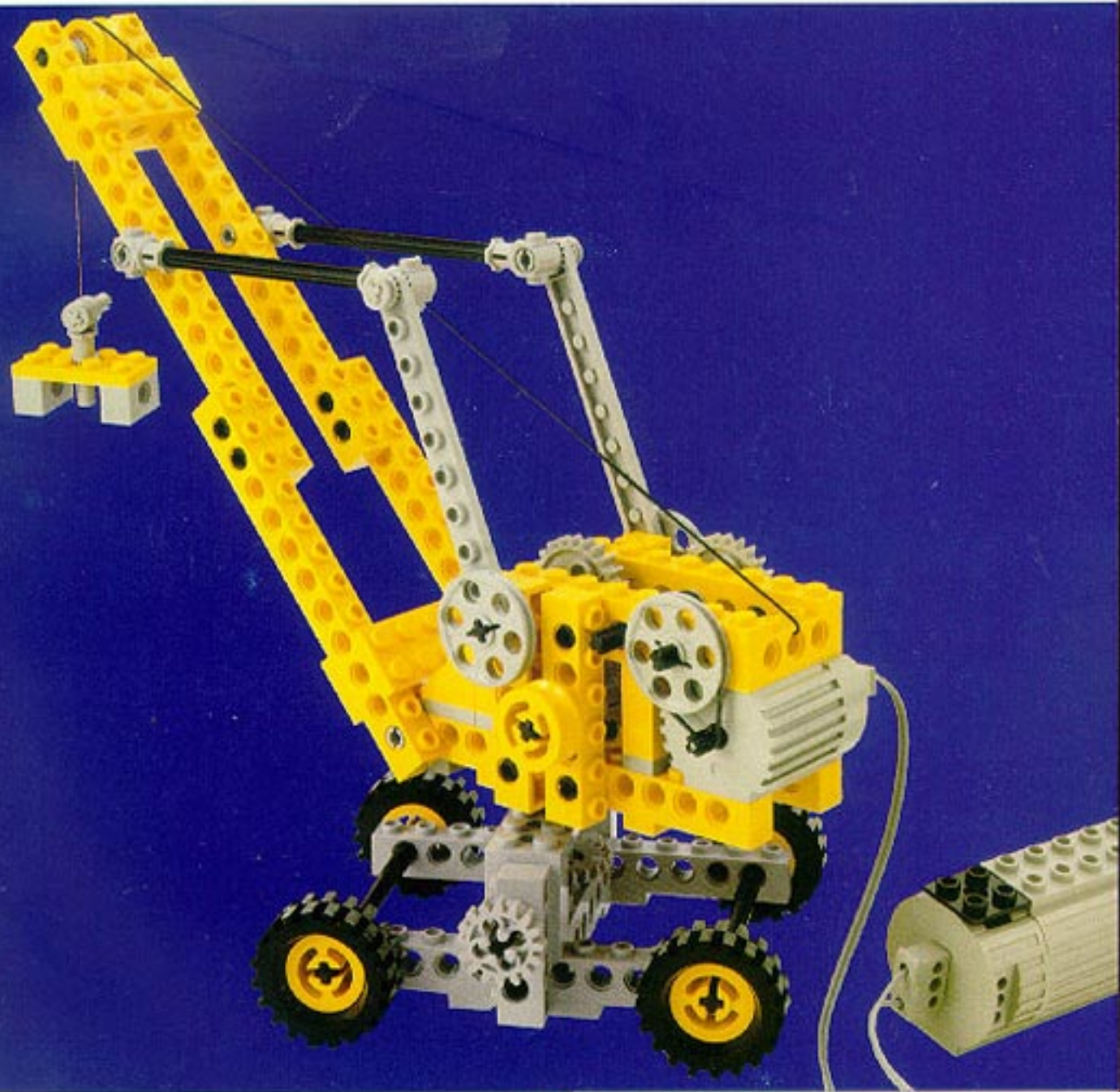

**Here's How to Operate  
Your 4.5 Volt Motor and  
Battery Control Unit.**

**Voici comment faire  
fonctionner votre  
moteur 4,5 V et son  
boîtier de contrôle.**

**Zo laat je de 4.5 Volt  
(batterij-) motor  
werken**

Lift off the lid of the battery box  
and insert 3 C-size batteries  
end-to-end as shown.  
Replace lid.  
(Batteries not included)

Soulevez le couvercle du boîtier  
et placez à l'intérieur 3 piles  
1,5 V bout à bout, comme illustré.  
Remplacez le couvercle.  
(les piles ne sont pas fournies).

Verwijder de afsluitdeksel van de  
batterijhouder. Koop 3 gelijke en  
passende staafbatterijen, (maat  
C) van elk 1,5 Volt en plaats die  
er (kop-aan-staart) in. Zet dan  
de afsluitdeksel weer op de hou-  
der.

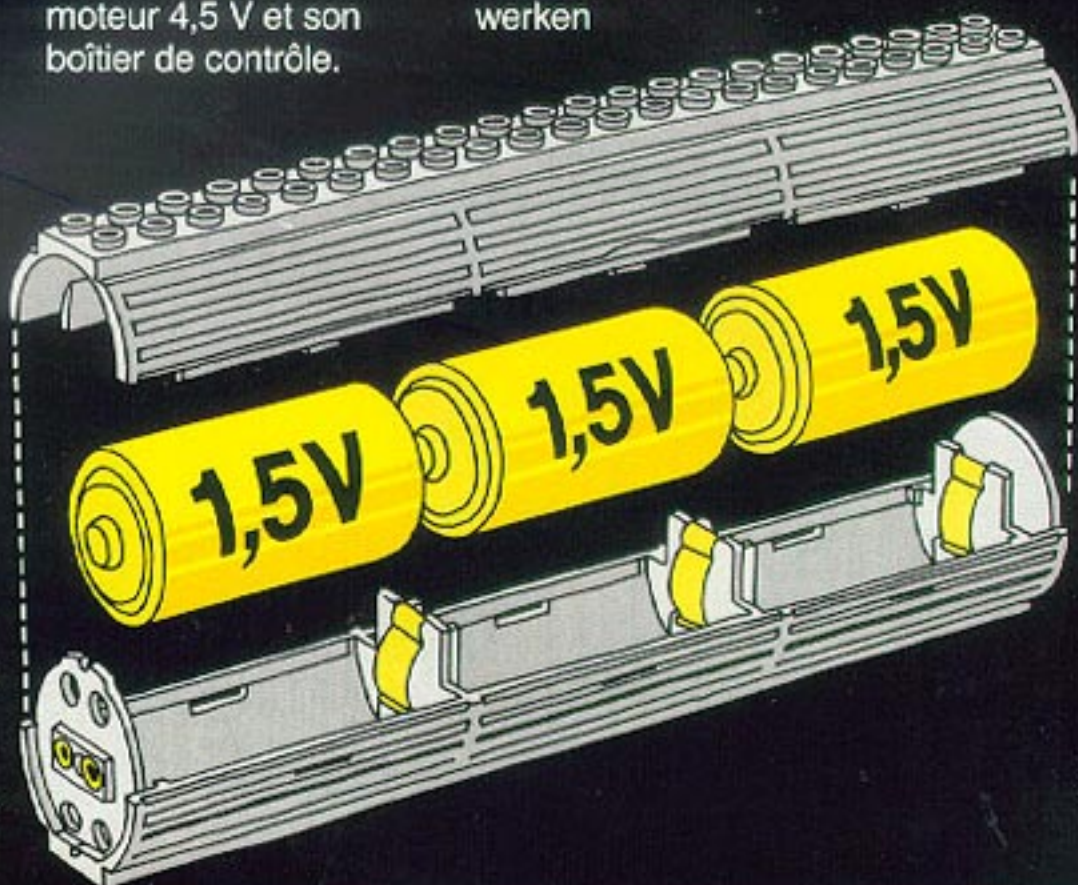

Attach the switch unit directly  
onto the battery box as shown.

Accrochez l'inverseur des pôles  
directement sur le boîtier à piles  
comme illustré.

Klem de omkeer-schakelaar op  
het uiteinde van de houder.

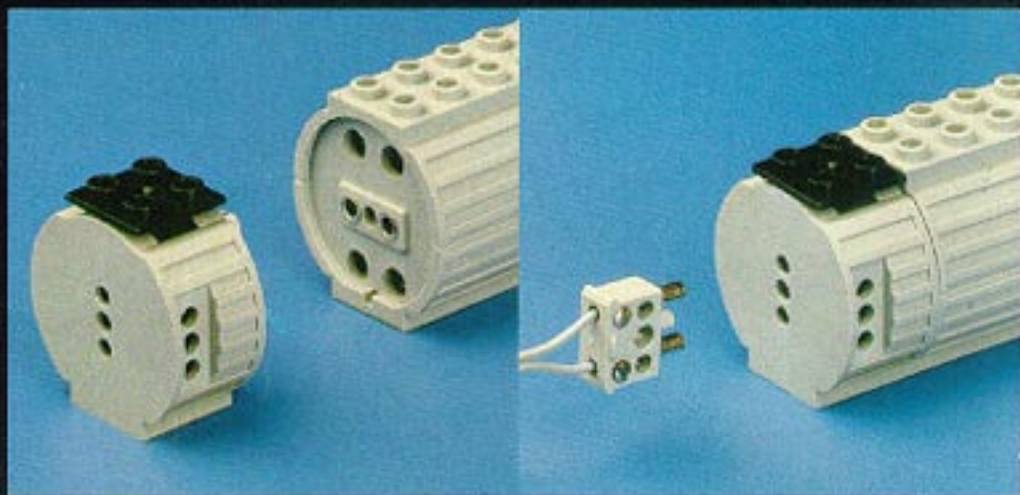

Connect the motor to the battery  
control unit with the motor wires  
provided.

Branchez le moteur sur le boîtier  
de contrôle avec les fils fournis.

Verbind de motor via een snoer-  
tje met de omkeer-schakelaar.



When the switch is in the centre position, the current is cut off. In the outer positions the motor goes either forwards or backwards. If the switch is only pressed lightly, it will automatically return to the centre position.

The switch unit can also be built directly onto the motor. The unit and battery rod are then connected with a wire.

Lorsque l'interrupteur est en position centrale, le courant est coupé. En positions latérales, le moteur tourne en avant ou en arrière. Si on appuie légèrement sur l'interrupteur, il retourne automatiquement à la position centrale.

L'inverseur peut être également construit directement sur le moteur. L'inverseur et le boîtier à piles sont alors reliés par les fils.

Staat de bedieningsknop in het midden dan is de verbinding verbroken. Beweeg je de knop naar links of rechts dan gaat de motor-as links- of rechtsom draaien. Als je de knop niet te ver opzij duwt zal hij het loslaten terug veren en dus de stroom automatisch uitschakelen.

Als je dat beter uitkomt, kun je de omkeerschakelaar ook direct aan de motor koppelen en dan met een aancortje verbinden met de batterijhouder.

## Helpful Hints

If the motor unit doesn't start, then check to see that:

a. Everything is connected in a firm and secure manner.

b. The batteries are inserted properly into the battery box.

If the motor still doesn't start, then replace the batteries.

If the model does not move along freely and easily it will use more power, thus draining the batteries more quickly. To prevent this adjust the gears so all parts run easily and without strain on the motor. Remember that gearing down lowers the strain on the motor and prolongs the life of the batteries.

Please note: Water may damage the motor! - Never pull the wire, but take hold of the plug itself when removing.

If you connect the motor to a transformer (e.g. LEGO® transformer art. no. 7864) then remember that the output must not exceed 4.5 volts. Use only transformers with a DC output. The motor is suppressed so that TV and radio reception are not disturbed.

## Batteries

Use three 1.5 volt batteries of a size to fit the three spaces in the battery box.

Read instructions on batteries carefully before use.

Be certain to install the batteries correctly in the battery box. To do this, observe the polarity signs ( $\pm$  symbols).

Incorrect installation when using batteries may result in battery leakage, or cause a short circuit. Check the batteries regularly. Remove the batteries if they are not used for a long period of time. Batteries can leak a corrosive fluid, which will damage the battery box.

When replacing batteries, replace all at the same time, i.e. never mix used and new batteries.

Do not use different types of batteries (e.g. zinc carbon, alkaline, rechargeable etc.) at the same time.

Rechargeable batteries may be used, but do not try to recharge the batteries in the battery box, always use a correct recharger.

Do not connect two or more battery boxes.

Be careful when connecting the battery box to the motor or lighting bricks.

Never plug the wire back into itself forming a complete loop or into another wire already connected to the battery box. This will cause a short circuit.

Do not throw used batteries in the fire!

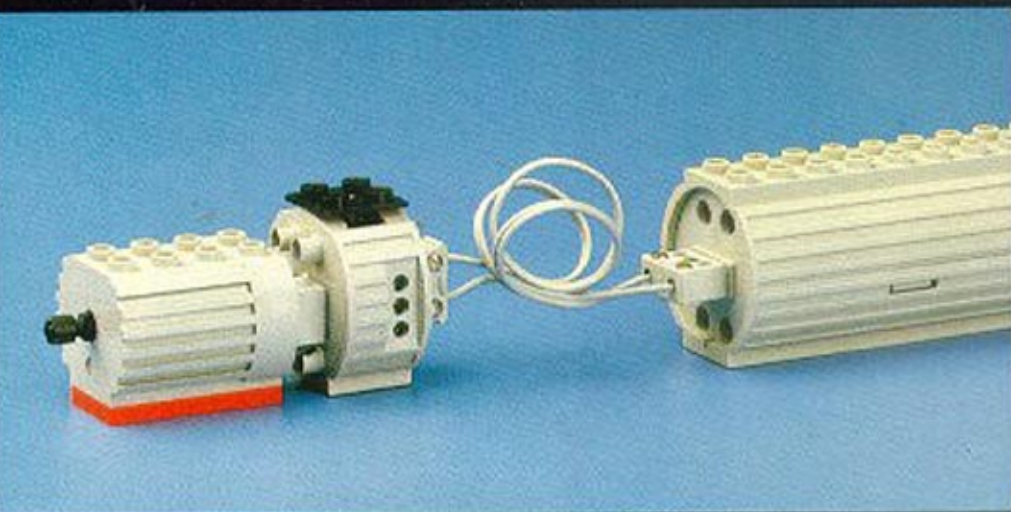

## Conseils utiles

Si le moteur ne démarre pas, vérifiez bien que:

— tous les branchements sont correctement et fermement reliés.

— les piles sont bien placées dans le boîtier.

Si le moteur continue à ne pas démarrer, remplacez les trois piles.

Un modèle doit bouger facilement et librement, sinon il consomme plus de courant et les piles s'usent plus vite. Pour éviter cela, ajustez les engrenages avec précision de sorte que toutes les pièces puissent bouger facilement sans surcharger le moteur.

Souvenez-vous qu'en réduisant la vitesse vous diminuez l'effort du moteur et vous prolongez ainsi la durée des piles.

Attention! L'eau peut endommager votre moteur. - Pour débrancher, ne tirez jamais sur le fil mais par la fiche.

Si vous reliez votre moteur à un transformateur (au transformateur LEGO® n° 7864, par exemple), vous devez limiter son usage à 4,5 V.

Utilisez seulement les transformateurs vous donnant du courant continu.

Le moteur est antisensibilisé pour ne pas perturber les réceptions radio ou TV.

## Piles

Utilisez trois piles 1,5 volt à la taille de l'emplacement prévu dans le boîtier.

Lisez attentivement les instructions données sur les piles avant de vous en servir.

Assurez-vous que les piles sont placées correctement dans le boîtier. Pour cela, respectez les signes de polarité (symboles  $\pm$ ).

Une installation incorrecte peut endommager les piles ou provoquer un court-circuit. Vérifiez régulièrement l'état des piles. Otez-les du boîtier si vous avez l'intention de ne pas les utiliser pendant un certain temps.

Les piles peuvent dégager un liquide corrosif qui endommagerait le boîtier.

Quand vous changez les piles, changez-les toutes en même temps, c'est-à-dire n'utilisez pas des piles neuves avec les piles usées.

N'utilisez pas différents types de piles en même temps (ne mélangez pas des piles zinc carbone avec des piles alcalines ou des piles rechargeables).

Vous pouvez utiliser des piles rechargeables. Toutefois, n'essayez pas de les recharger dans le boîtier. Utilisez toujours le rechargeur qui convient.

Ne branchez jamais deux ou plusieurs boîtiers à piles ensemble.

Soyez prudents lorsque vous branchez le boîtier à piles au moteur ou aux briques lumineuses. Ne branchez jamais le fil à l'arrière du boîtier en formant une boucle complète ou dans un autre fil déjà relié au boîtier. Cela provoquerait un court-circuit.

Ne jetez jamais des piles au feu!

## Nuttige tips

Als de motor niet direct start, controleer dan:

a. Alle stekker aansluitingen.

b. Of de batterijen goed (en in de juiste richting) in de houder zijn geplaatst.

Lukt het dan nog niet, vervang dan de batterijen. Als je werkstuk stroef draait moeten je batterijen meer stroom afgeven en zullen dus eerder leeg zijn.

Kontroleer daarom regelmatig, al tijdens het bouwen, het soepel lopen; telkens na het aanbrengen van een as, wiel of kiemnippel.

En onthoud: als een groot tandwiel een kleiner moet aandrijven kost dat meer stroom dan omgekeerd.

Let op: Voorkom het vochtig worden van de motor (kortsluiting) en trek de stekkers nooit los door aan de draden te trekken. Wanneer je de motor niet met batterijen wilt voeden kun je eventueel een transformator gebruiken (bijv. LEGO nr. 7864) maar die mag alleen - en niet meer dan 4,5 Volt - gelijkstroom afgeven (en dus nooit wisselstroom).

De motor is voorzien van een storings-onderdrukker waardoor de ontvangst van radio en televisie niet gehinderd wordt.

## Batterijen:

Lees altijd de aanwijzingen op de batterijen en let bij het plaatsen in de batterijhouder op de juiste pool-richting (+/- symbolen).

Daarmee verminder je de kans op kortsluiting en lekkage.

Kontroleer je batterijen regelmatig en verwijder ze uit de houder als ze leeg zijn of als je denkt er enige weken niet mee te werken.

Ze bevatten een bijtend zuur dat bij lekkage de houder ernstig kan aantasten. Vervang altijd alle batterijen gelijktijdig en combineer nooit verschillende soorten (alkaline, zink-koolstof, herlaadbaar enz.) Mocht je herlaadbare batterijen gebruiken dan moet het opladen altijd in een oplaad-apparaat gebeuren en nooit in de batterijhouder.

Verbind een batterijhouder nooit met een andere stroombron (of andere Batterijhouder).

Om kortsluiting te voorkomen mogen stroomdraden die uit de batterijhouder komen nooit verbonden worden met een andere stekker of draad die al op de batterijhouder is aangesloten.

En tenslotte: Gooi lege batterijen niet zomaar weg of in open vuur.

Bescherm ons milieu en lever ze in bij een winkel waar je batterijen kunt kopen.

Met deze aanwijzingen hopen wij je langer, leuker en veiliger te kunnen laten genieten van je bewegende LEGO werkstukken.

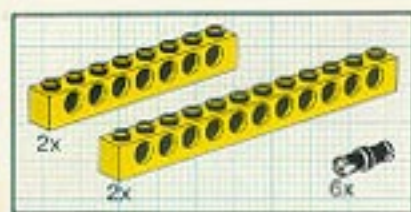

**1**

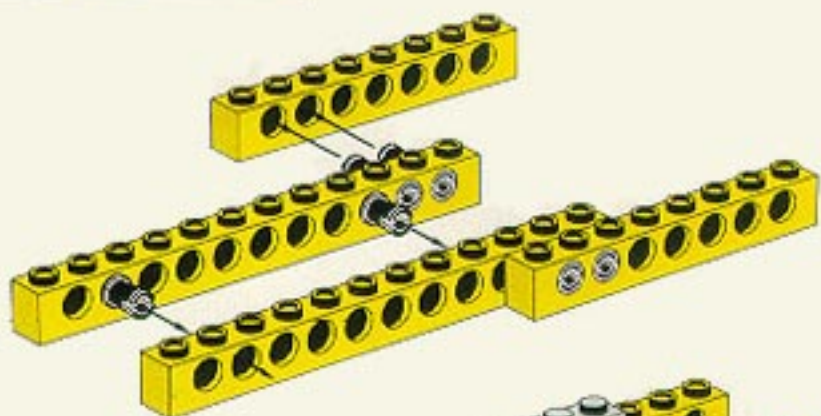

**2**



**3**

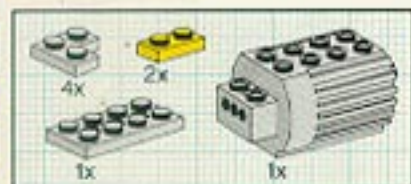
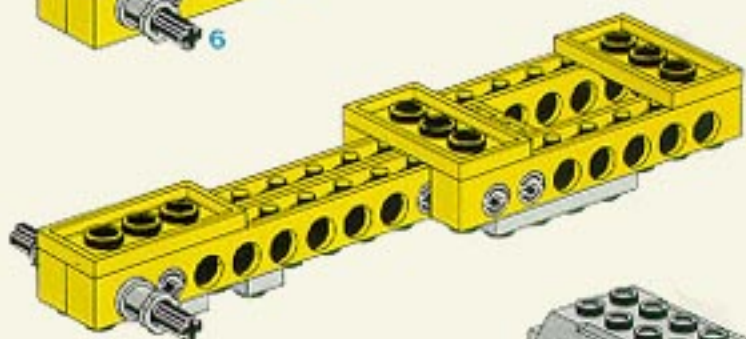

**4**

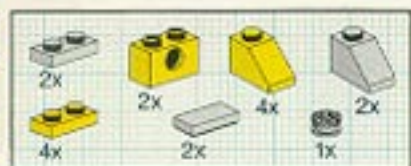
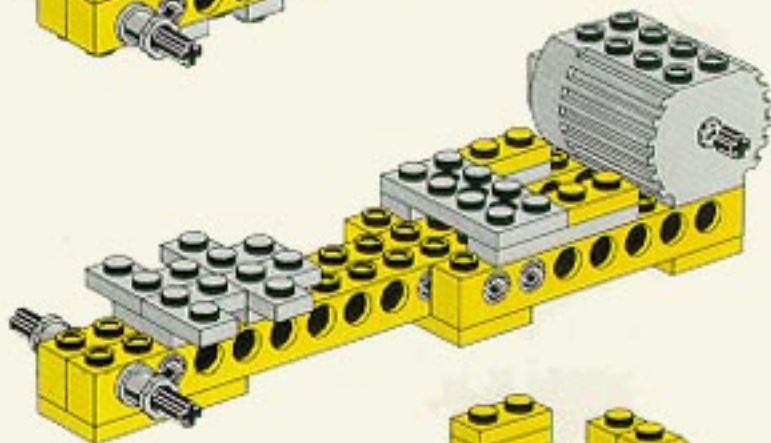

**5**

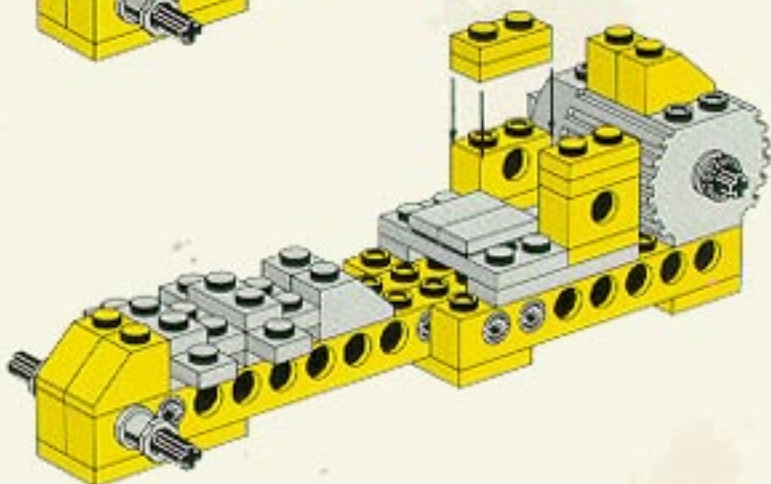

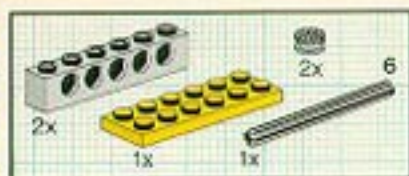

6

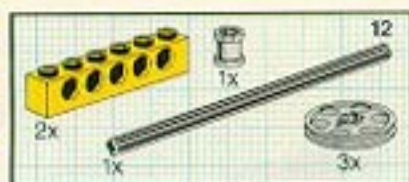
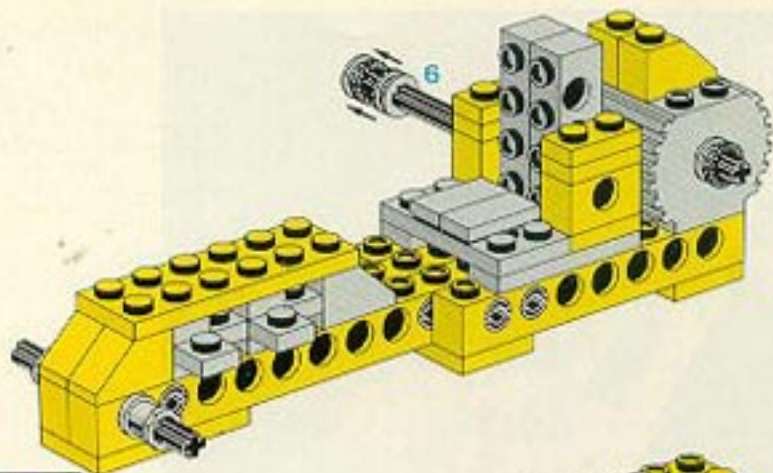

7

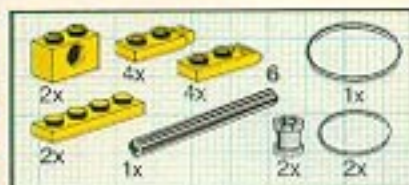
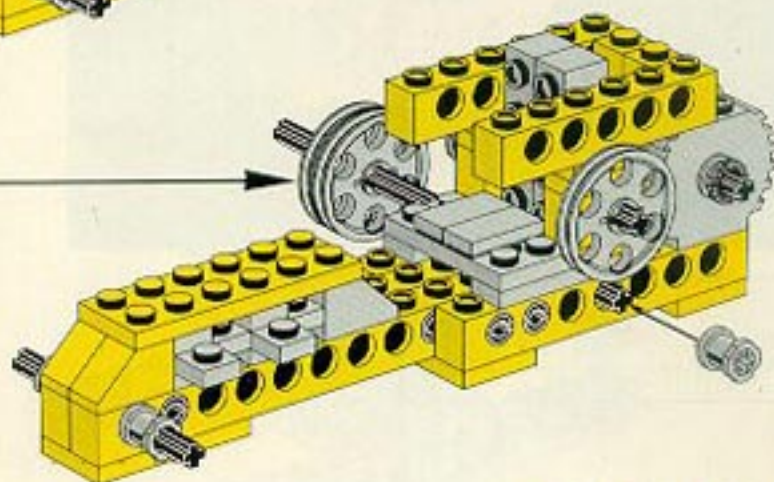

8

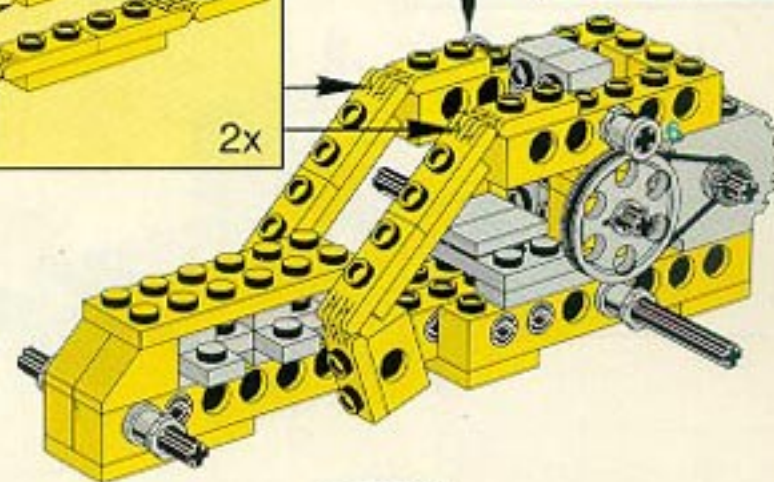
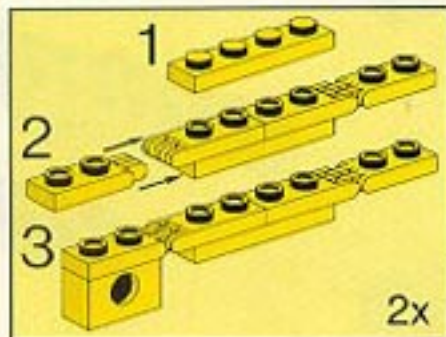

9

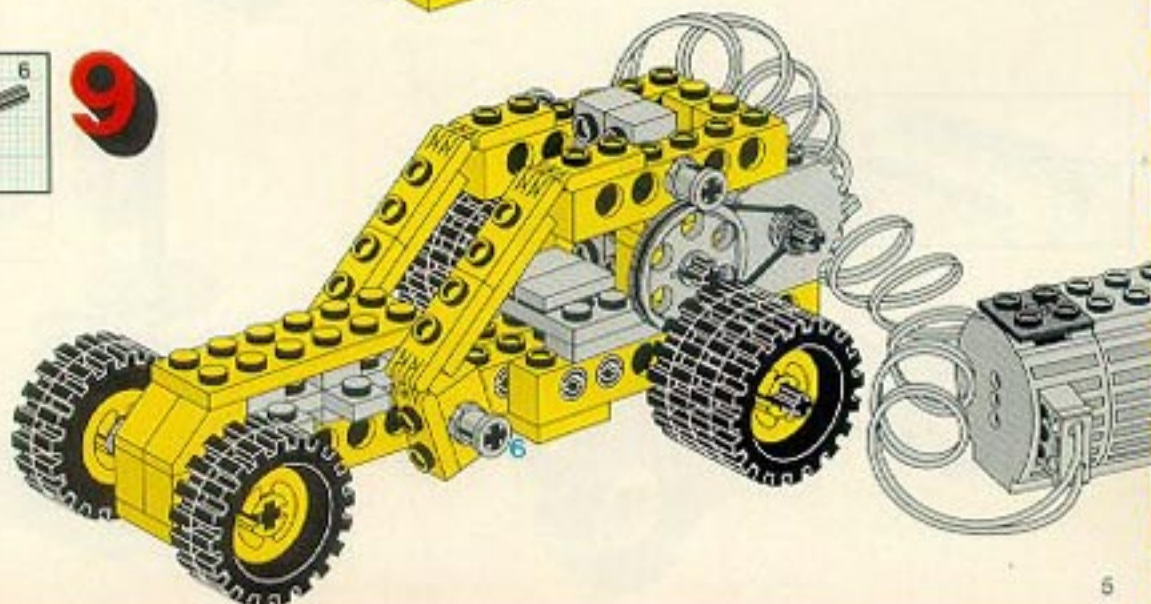



**1**

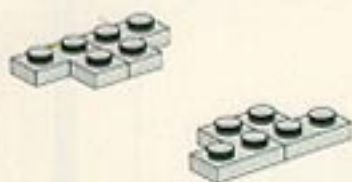

**2**

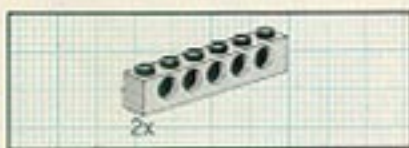
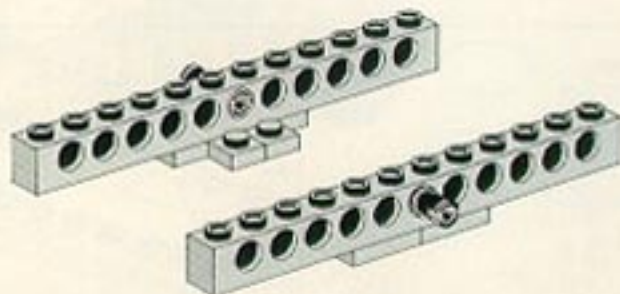

**3**

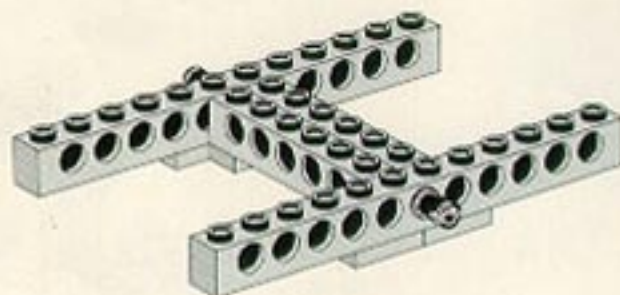

**4**

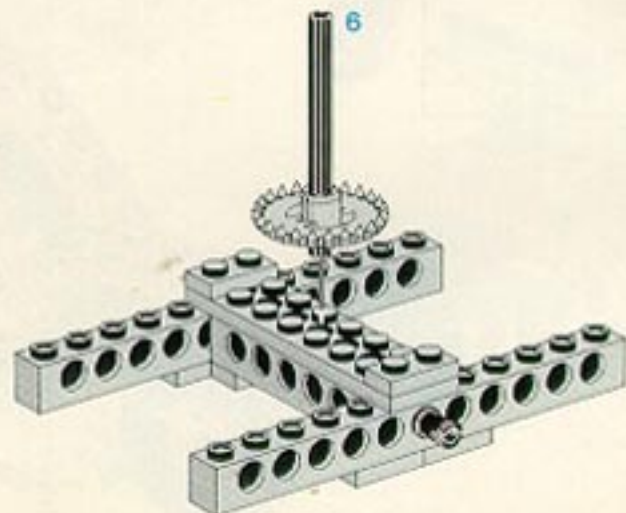

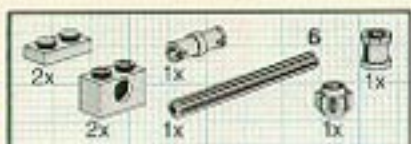

**5**

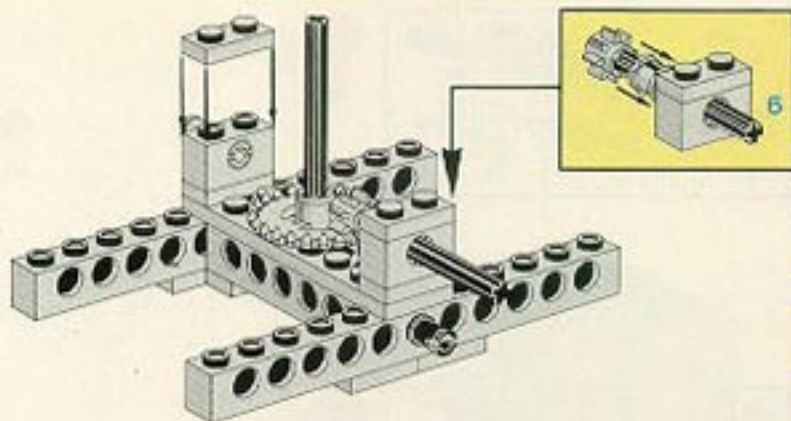

**6**

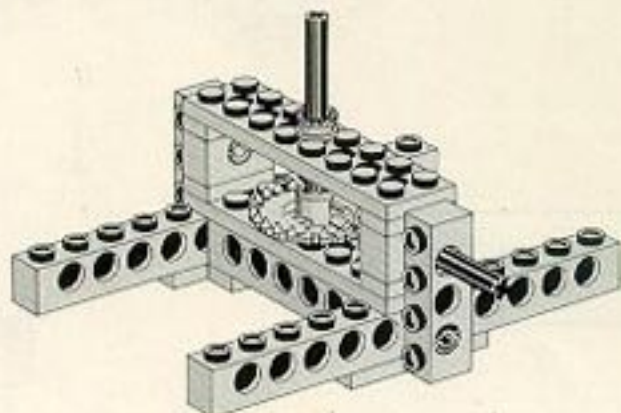

**7**

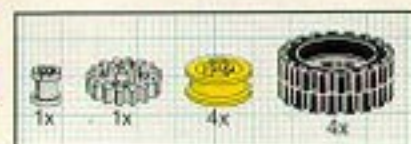
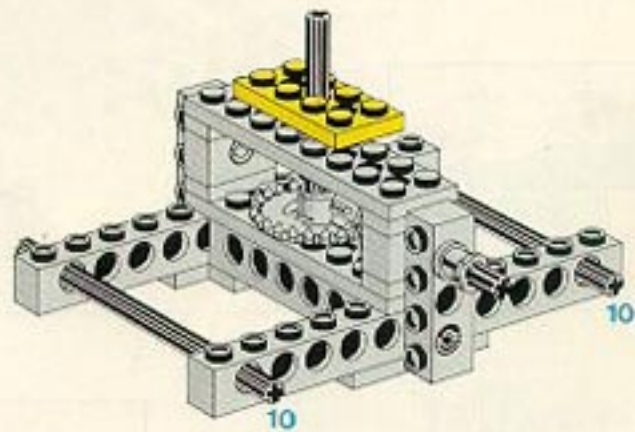

**8**

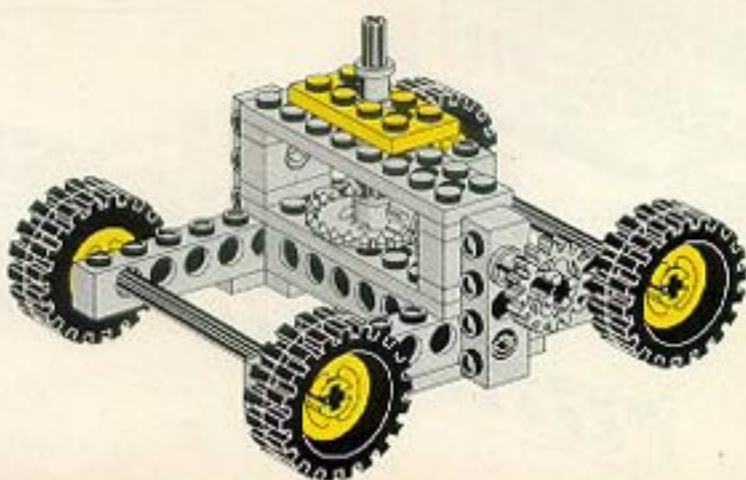

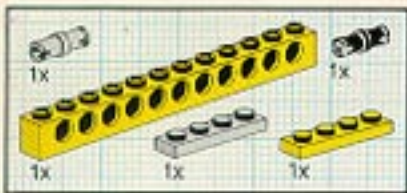

1

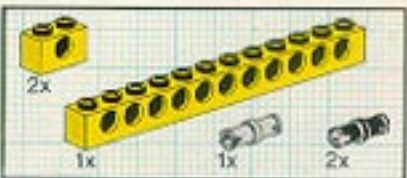
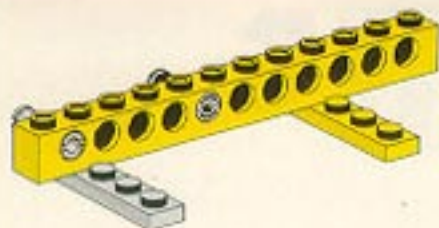

2



3

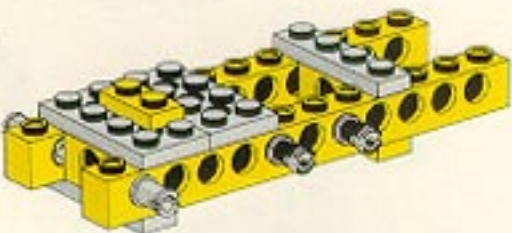

4

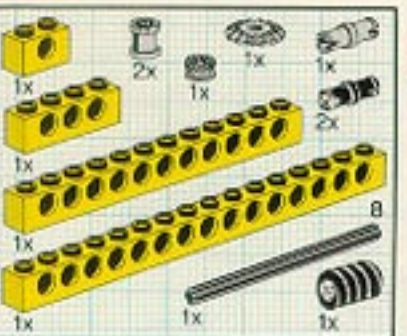
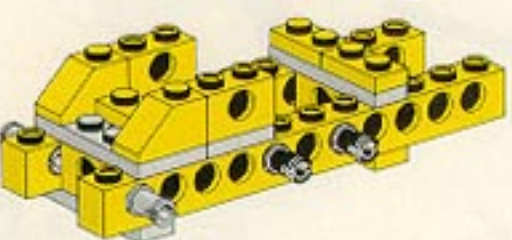

5

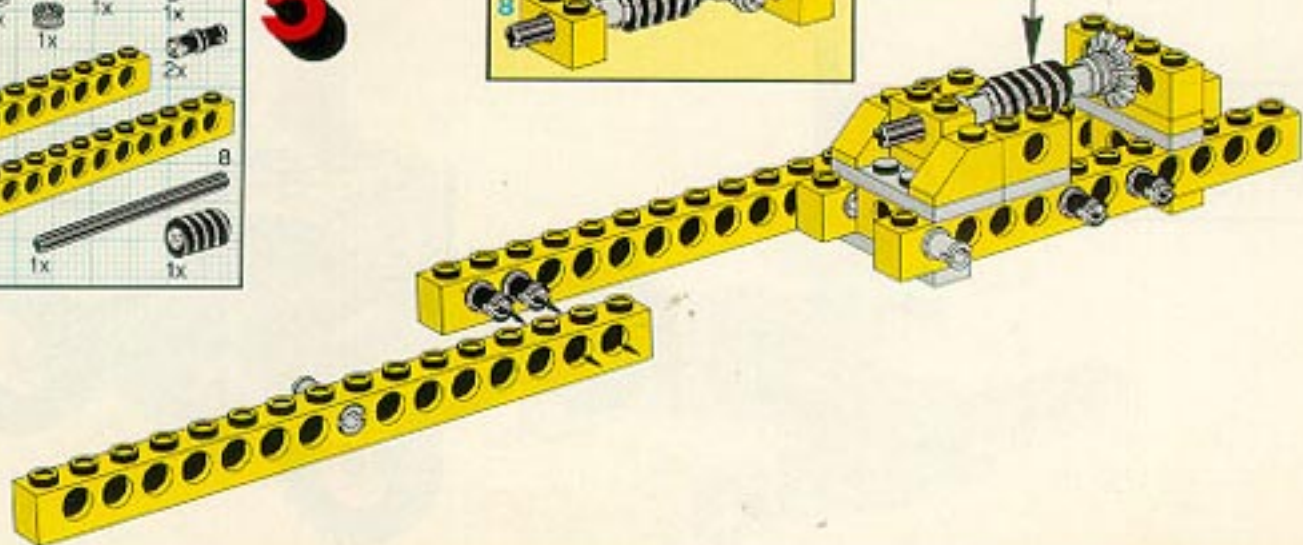
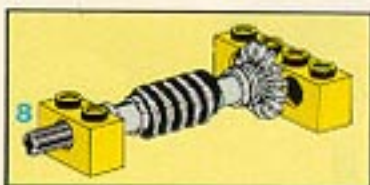





# 8

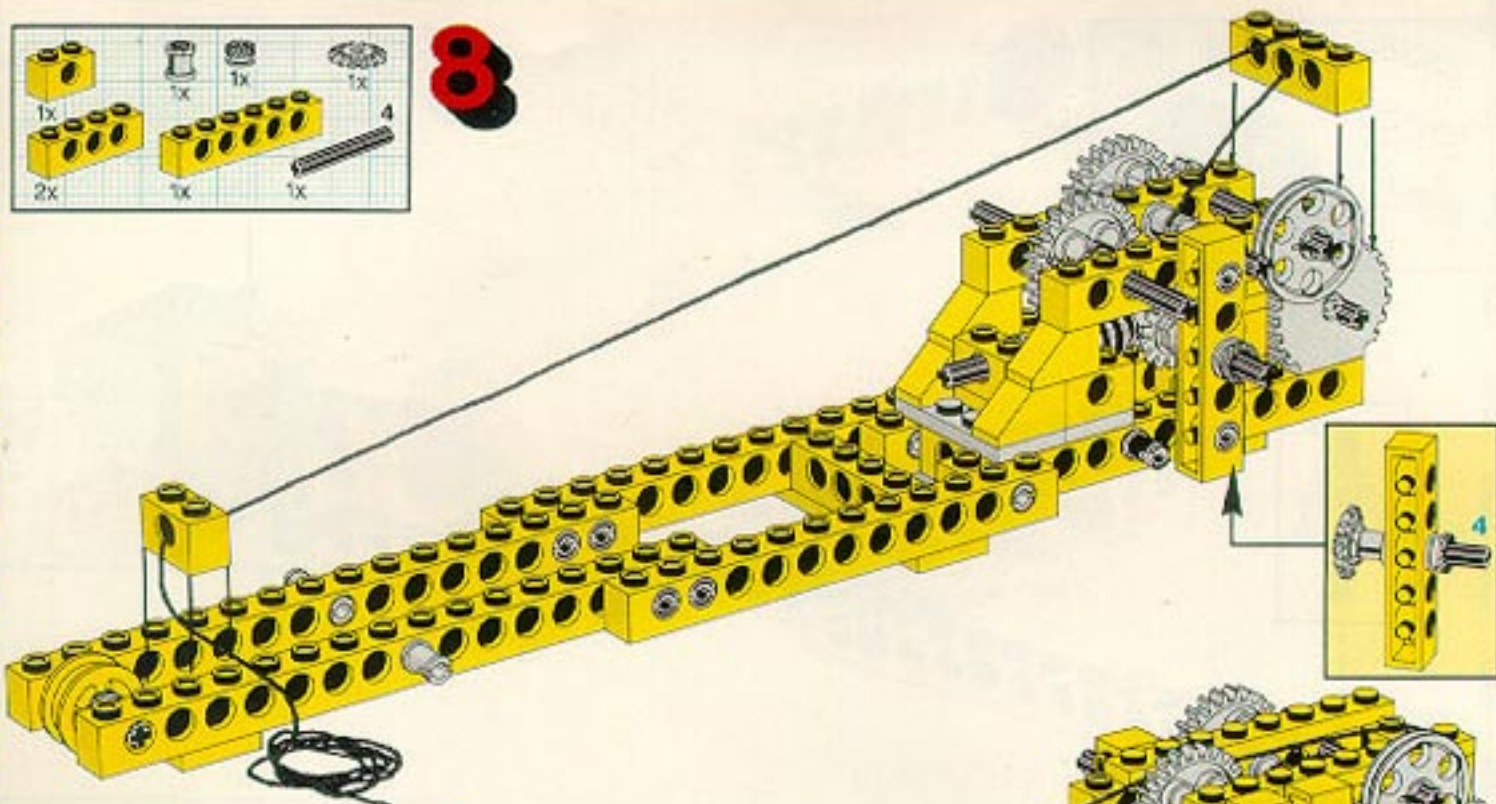
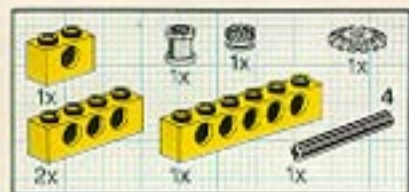

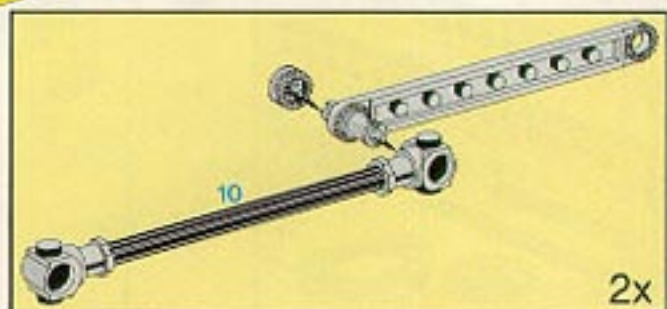
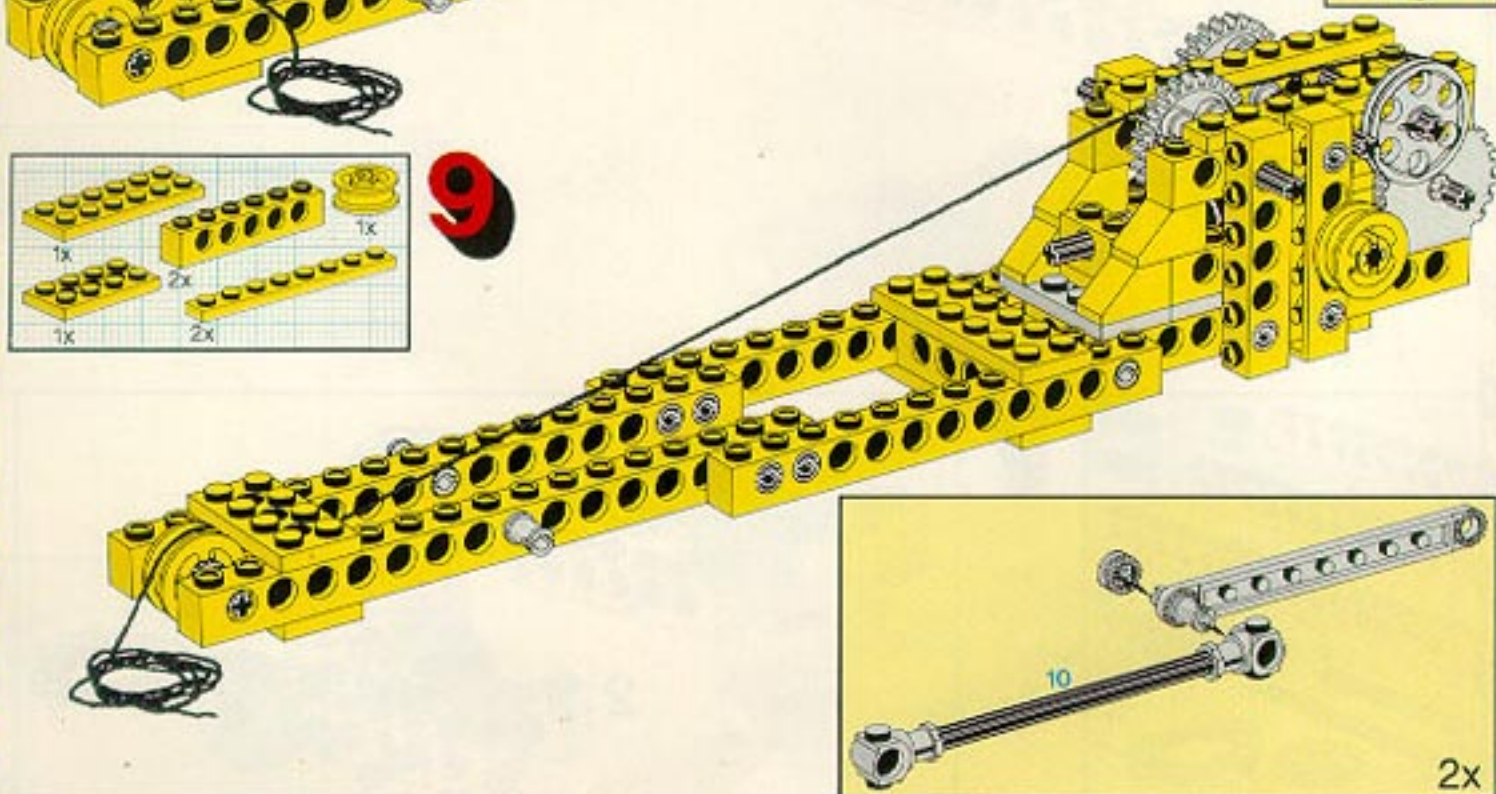
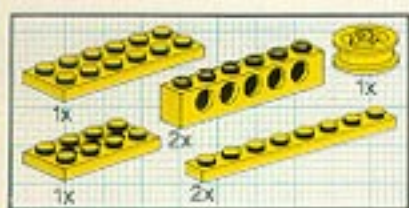

# 9

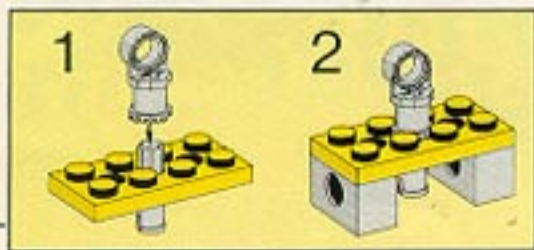
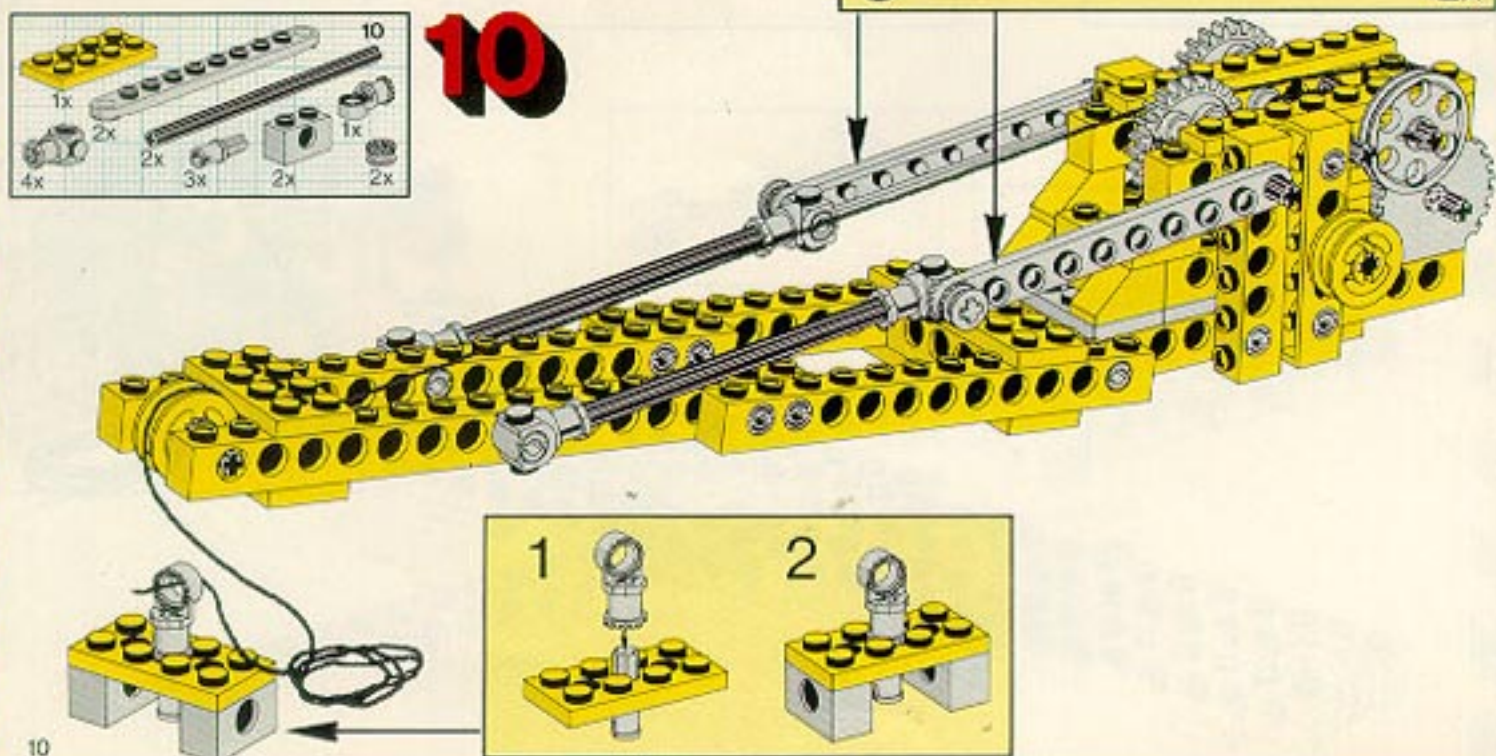
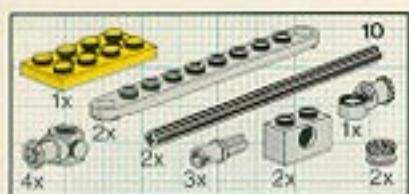

# 10



11

			
1x	1x	2x	1x

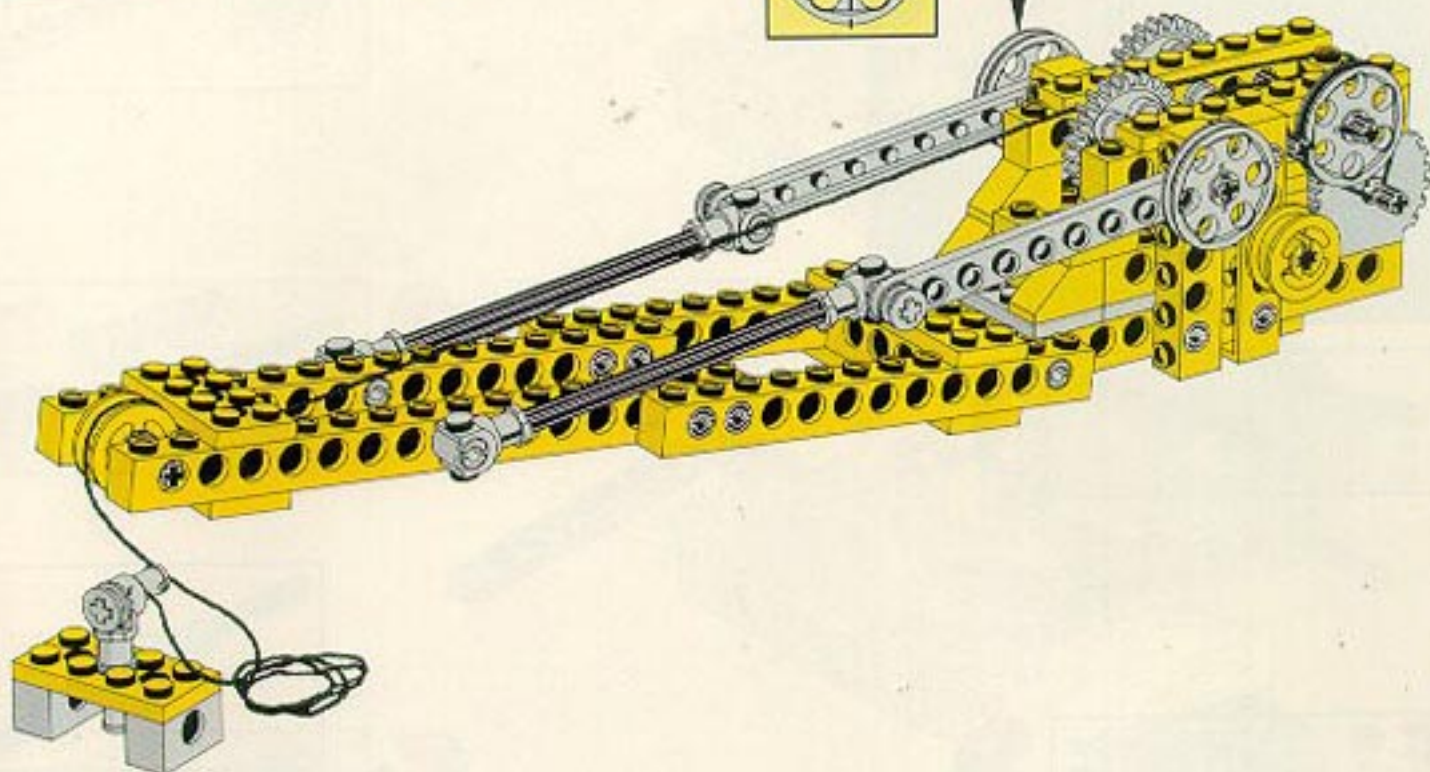

12

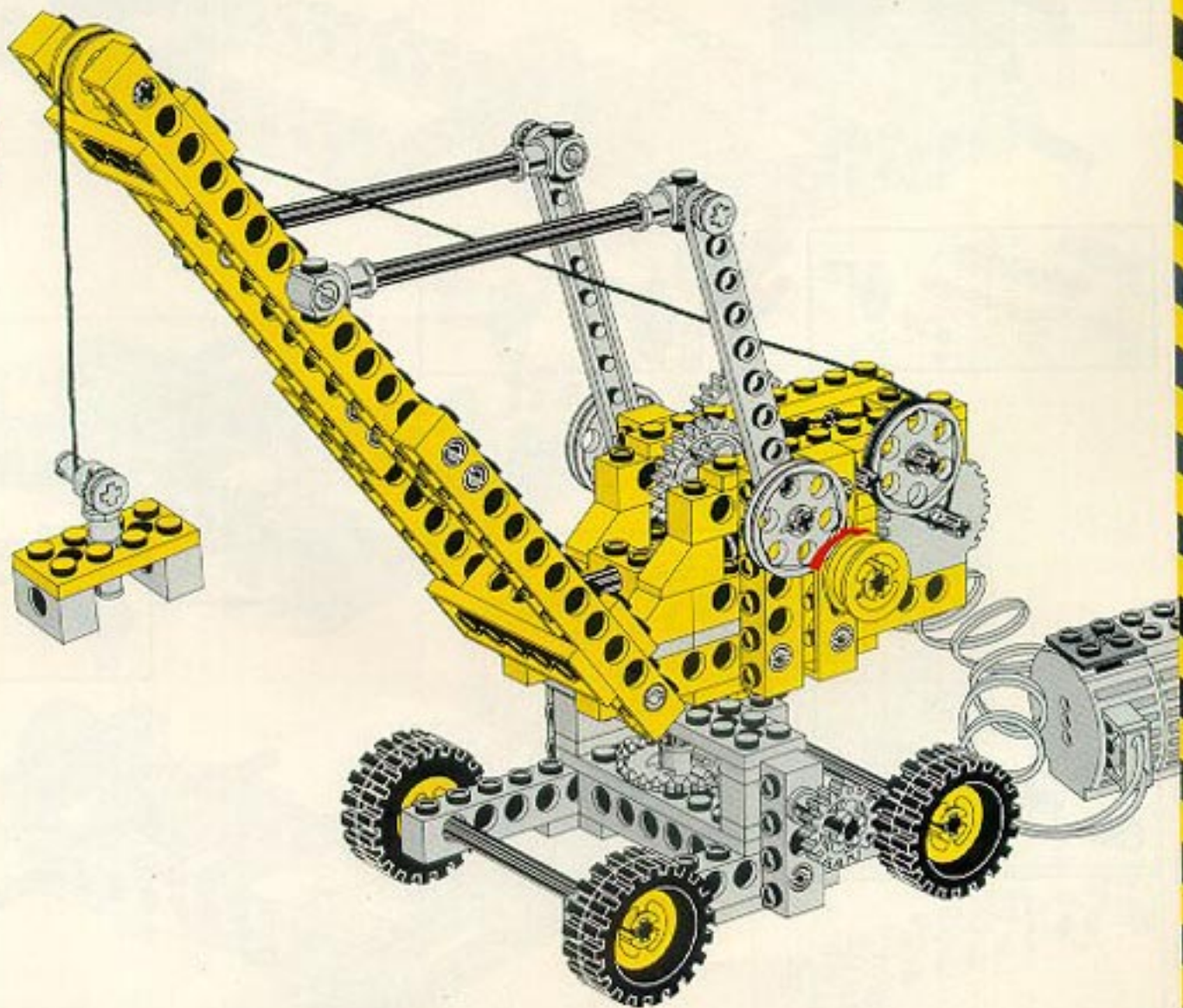



1

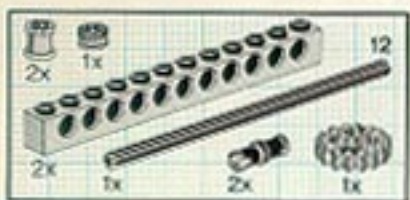
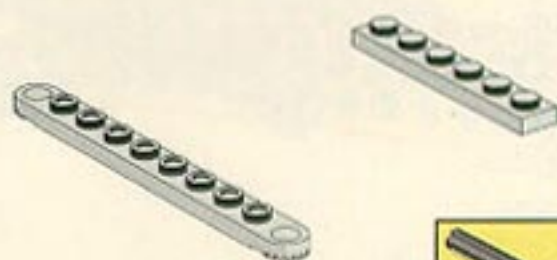

2

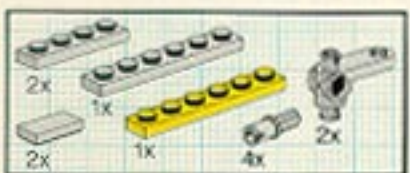
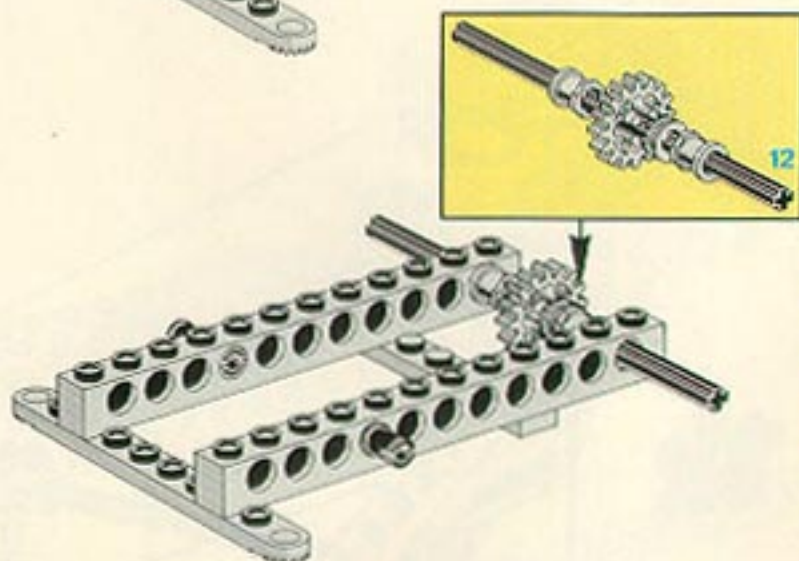

3

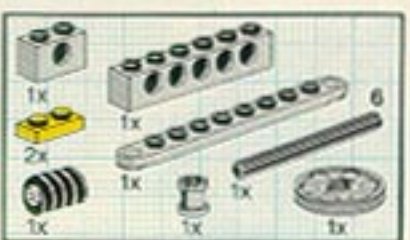
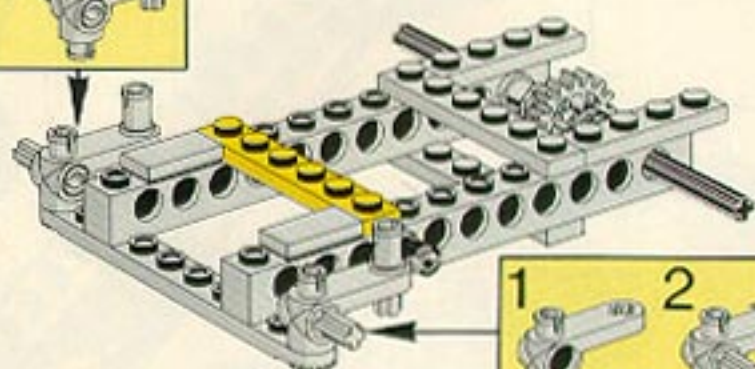

4

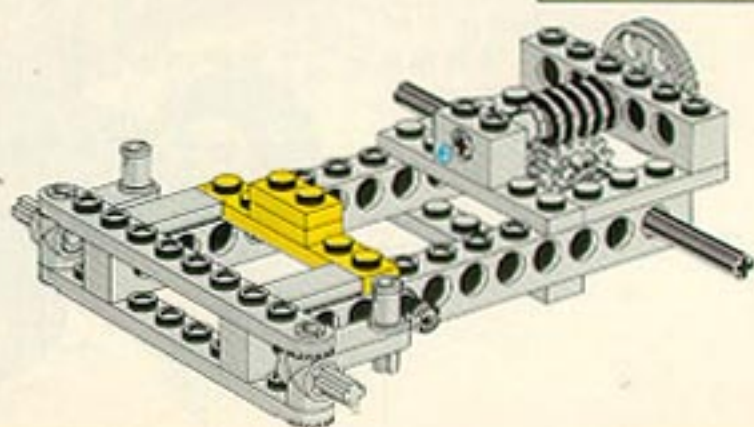

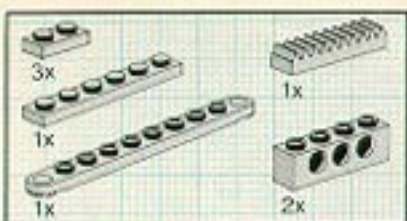

5

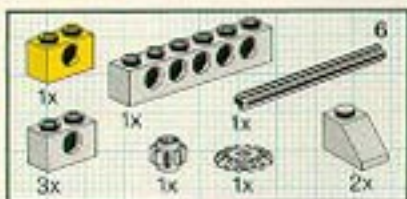
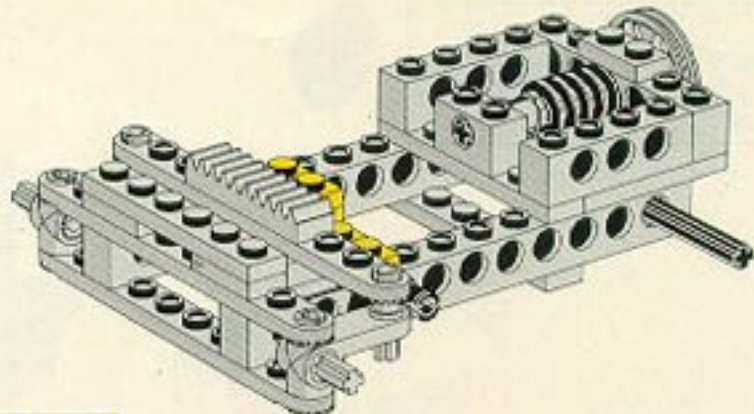

6

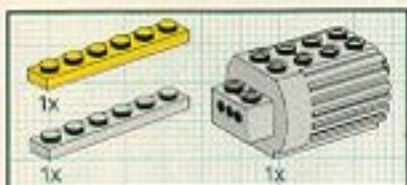
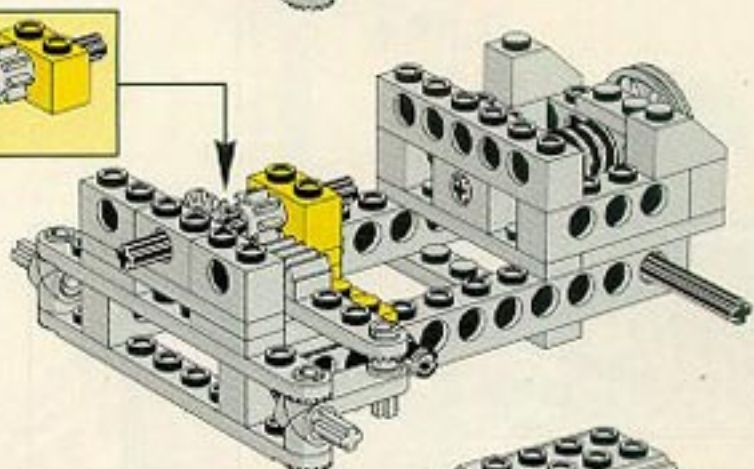

7

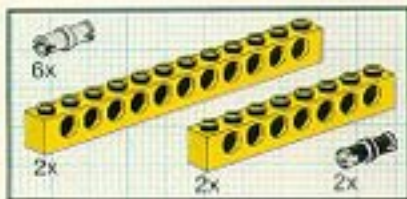
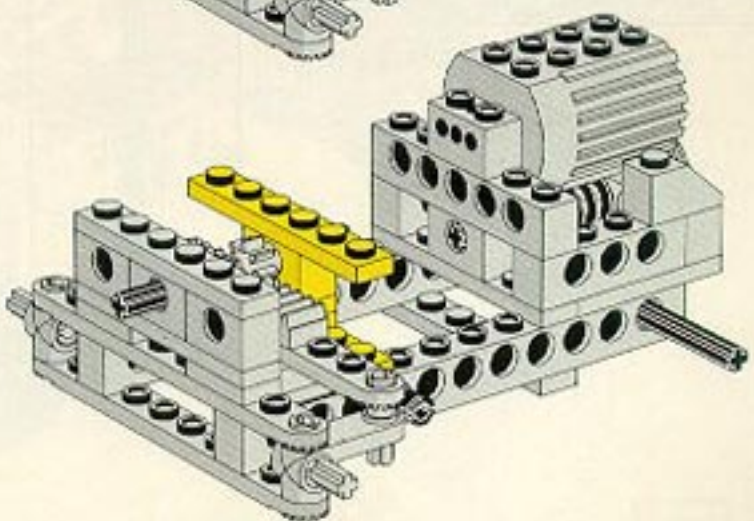

8

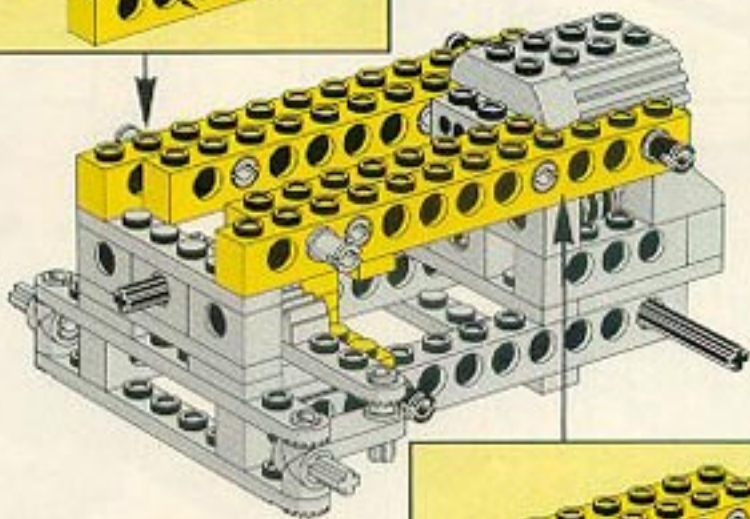
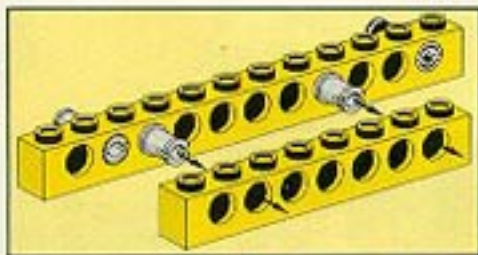

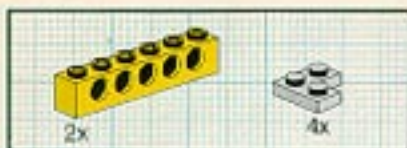

9

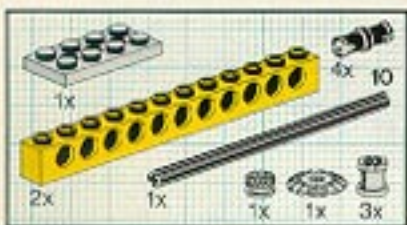
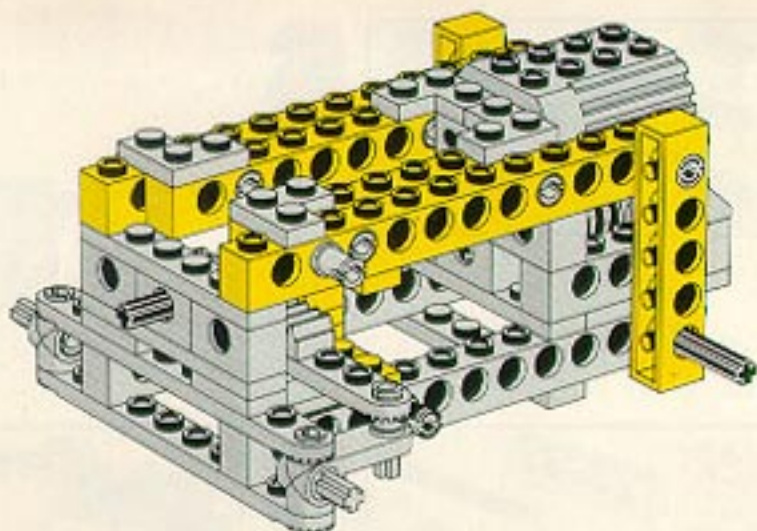

10

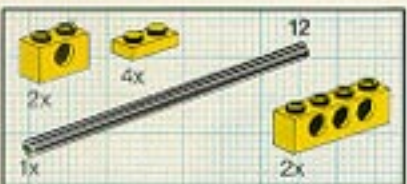
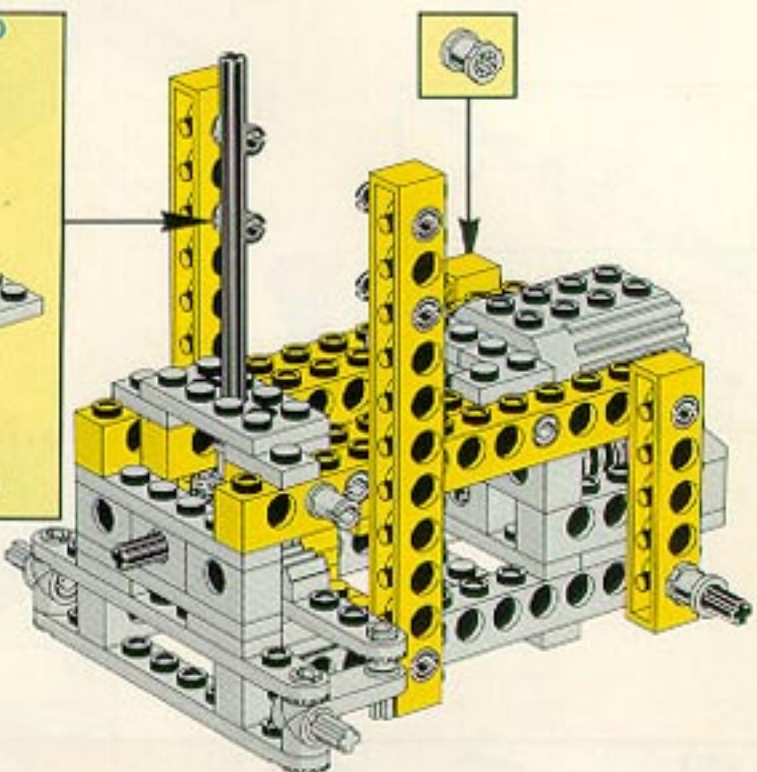

11

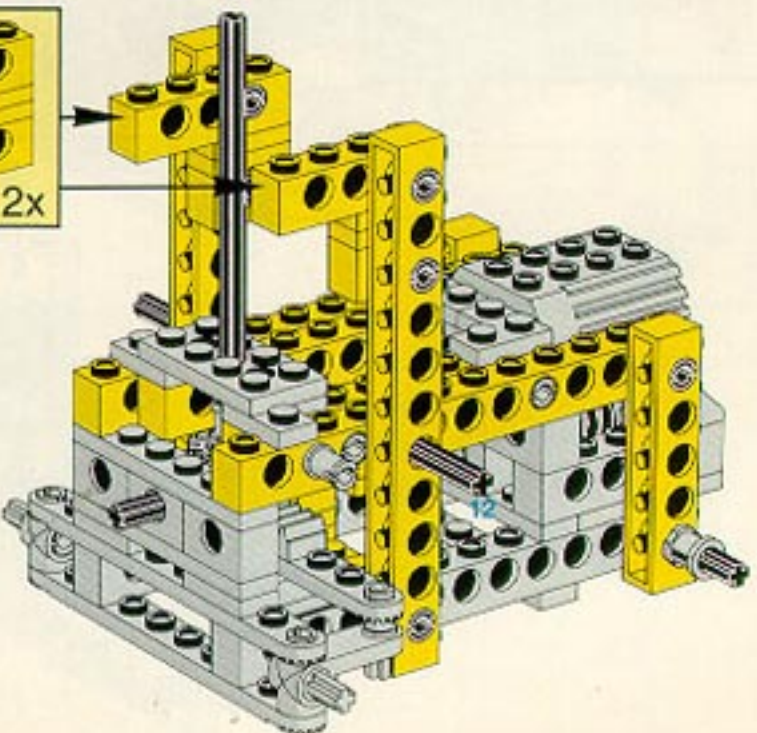
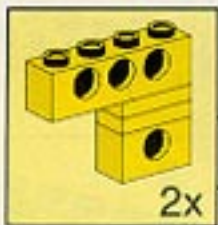

# 12

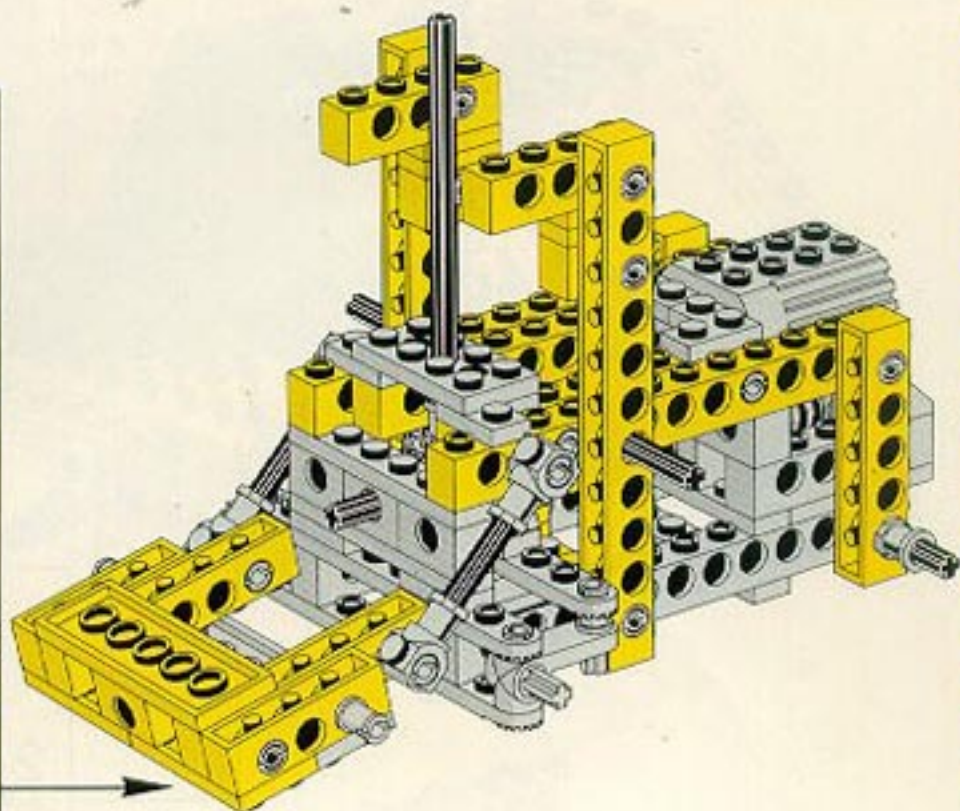
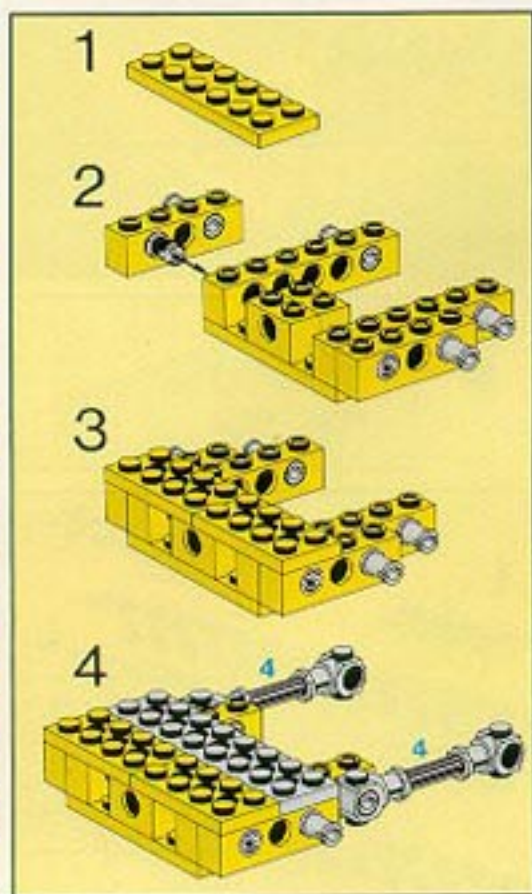
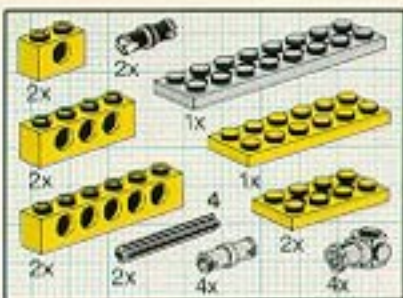

# 13

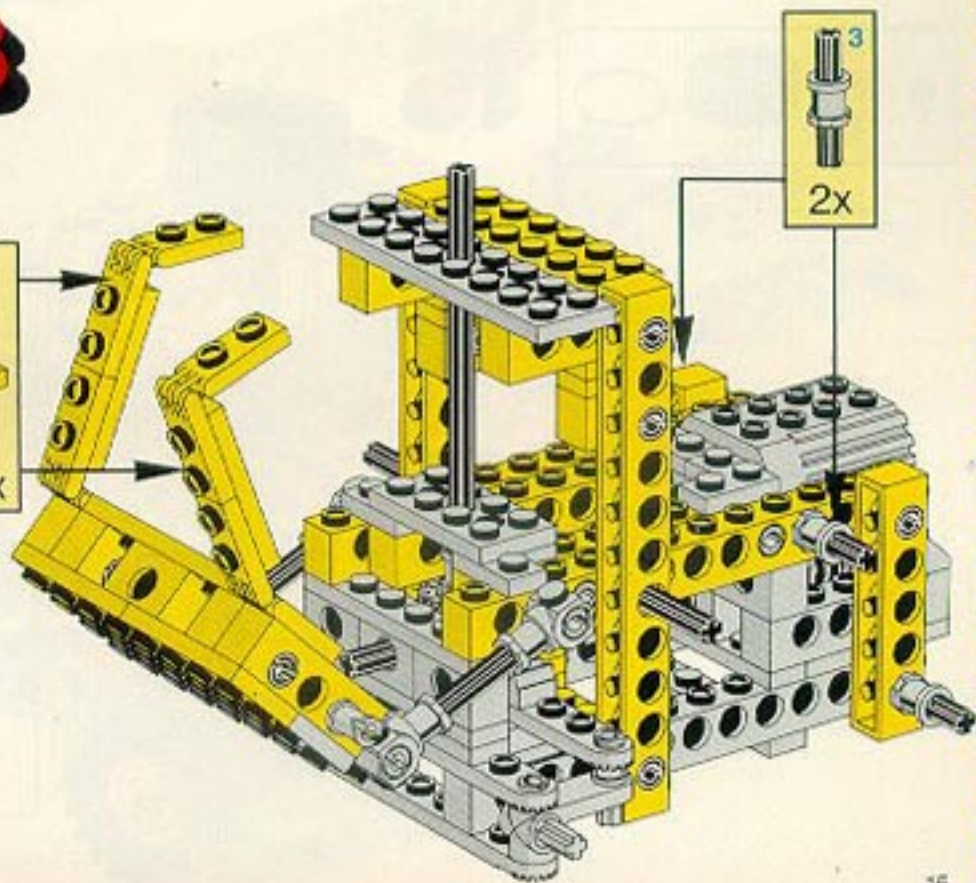
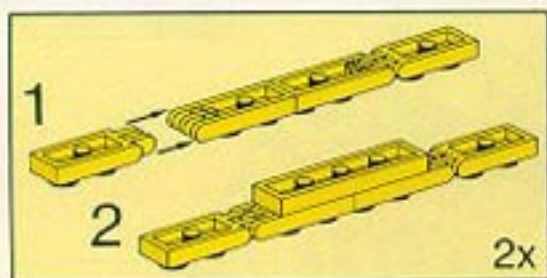
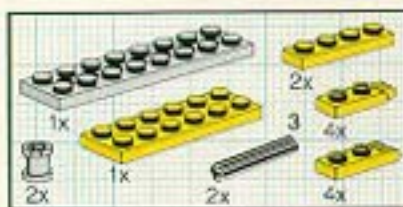

# 14

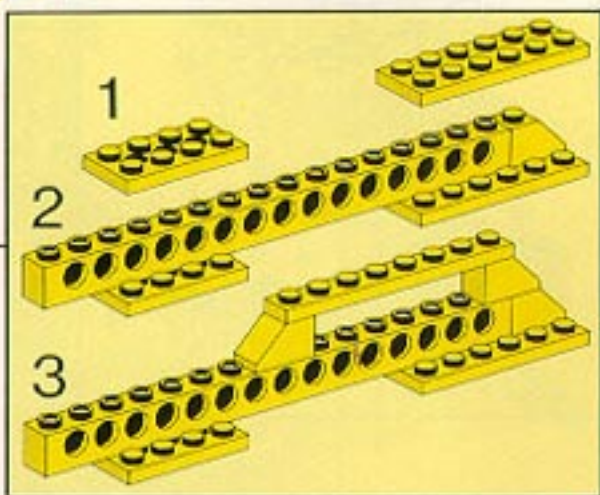
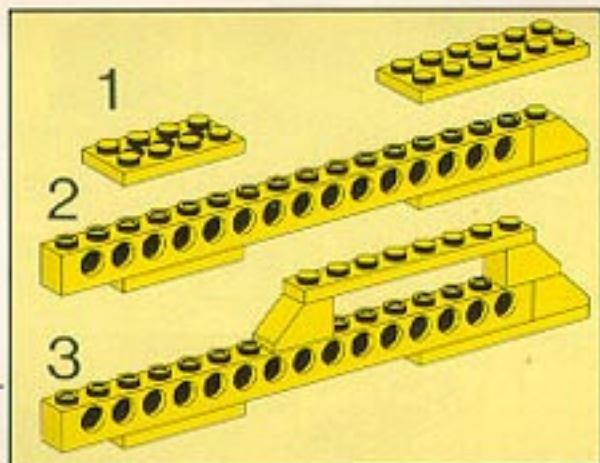
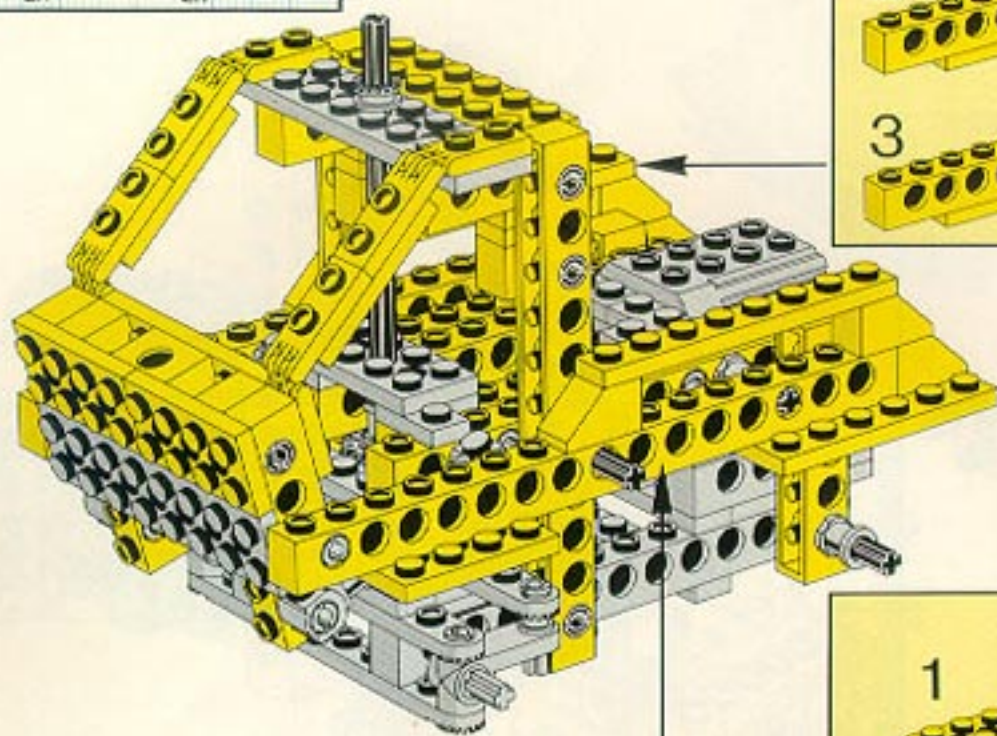
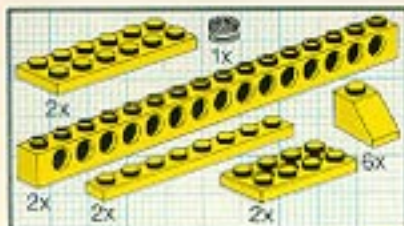

# 15

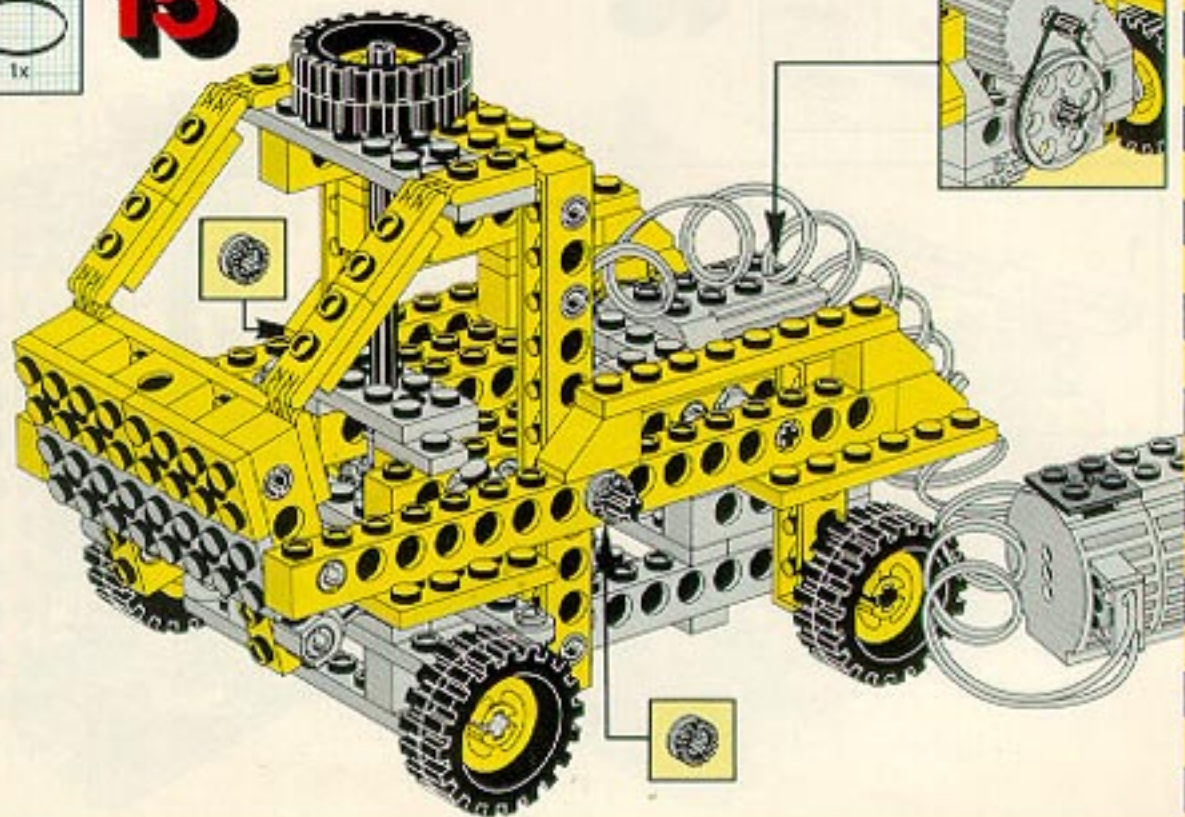



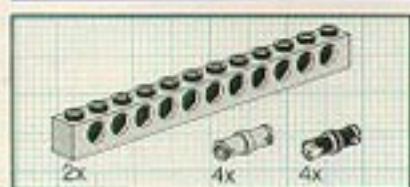
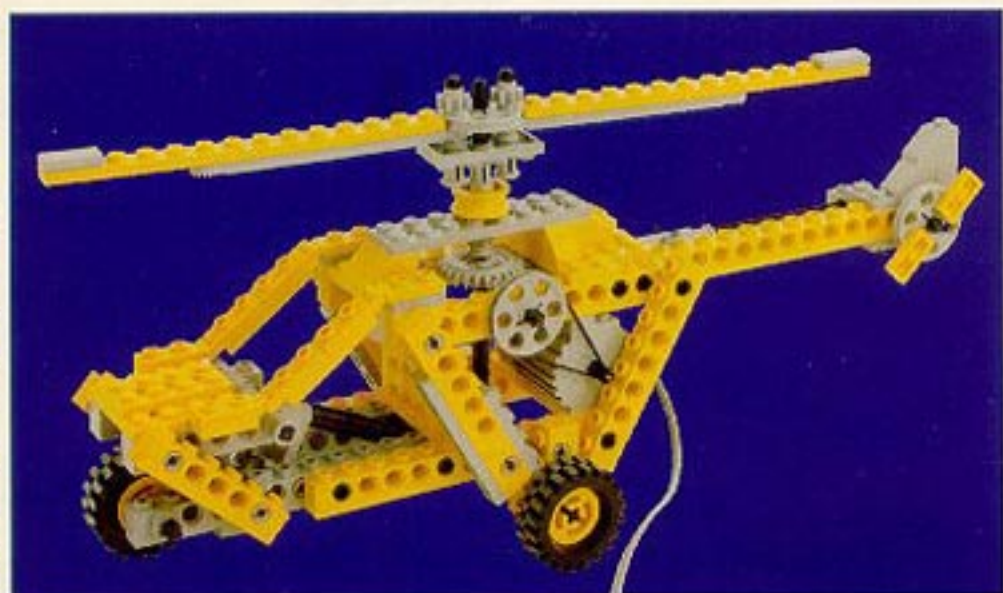

1

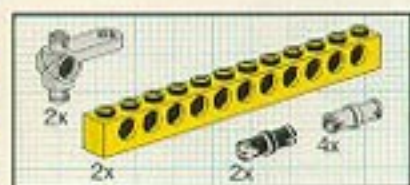
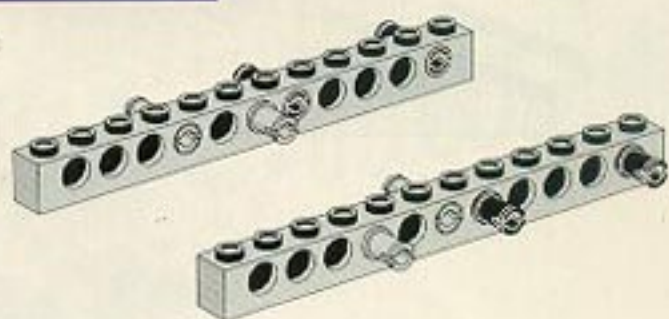

2

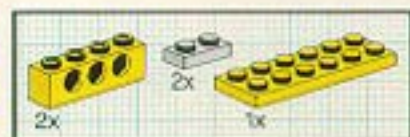
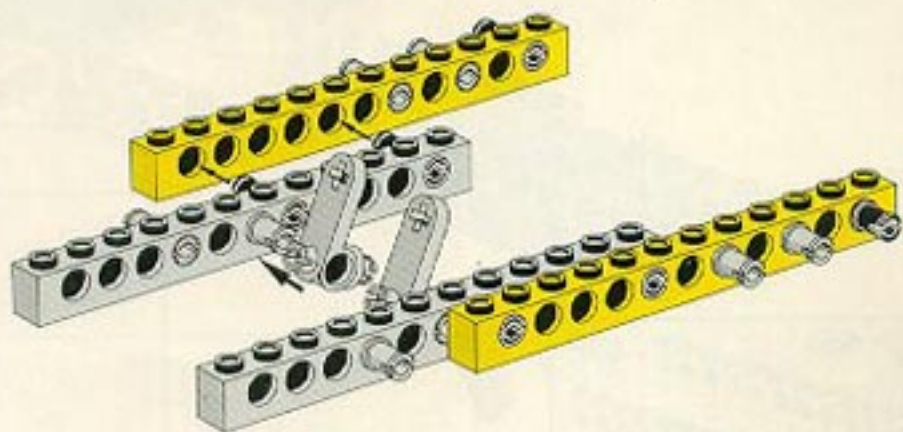

3

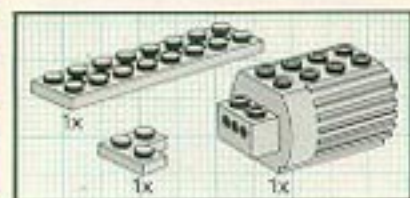
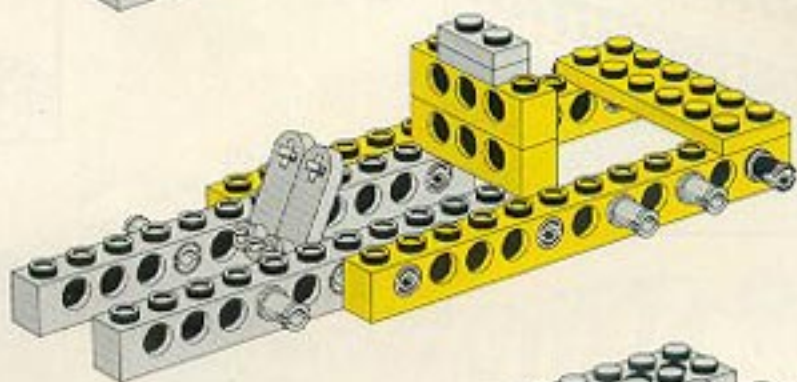

4

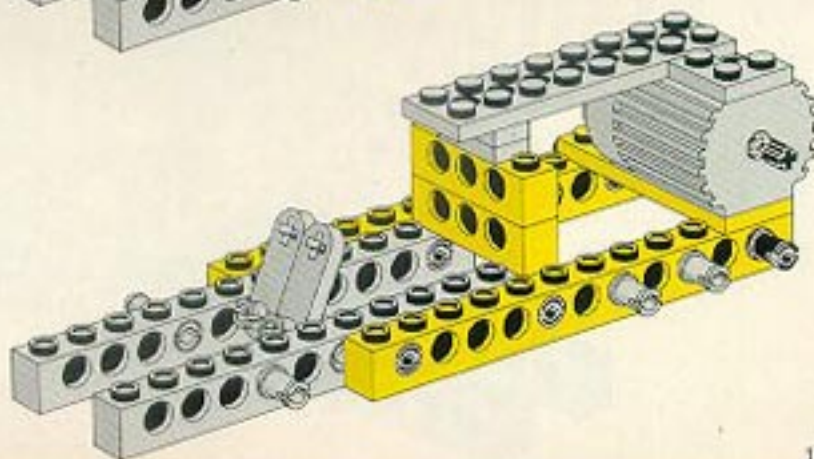



**5**

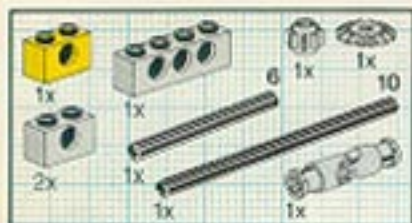
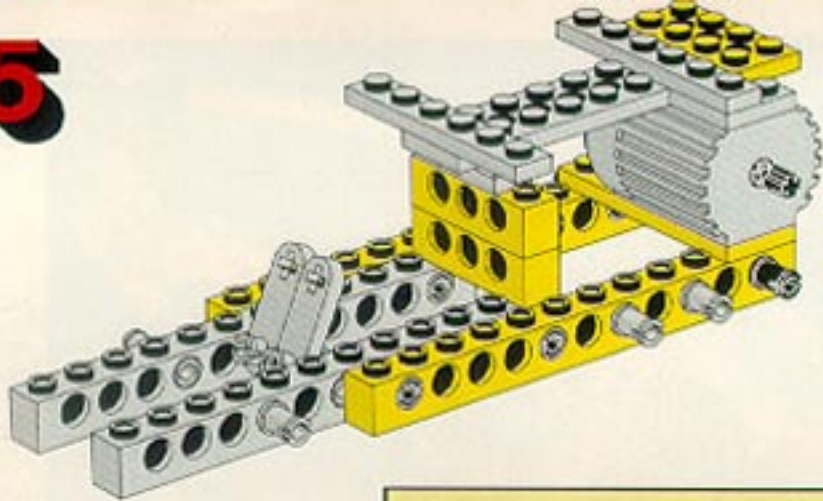

**6**

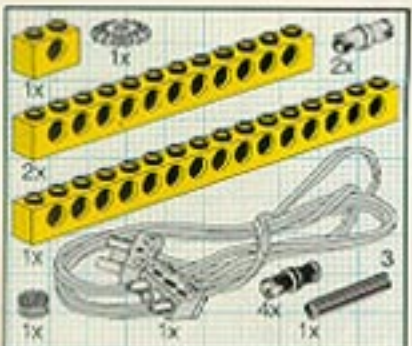
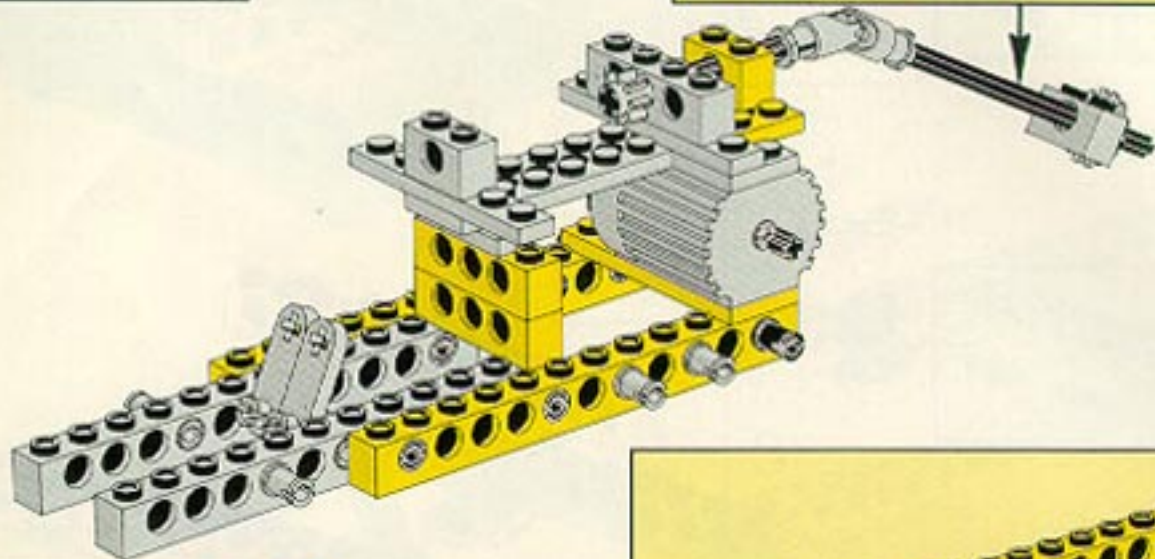
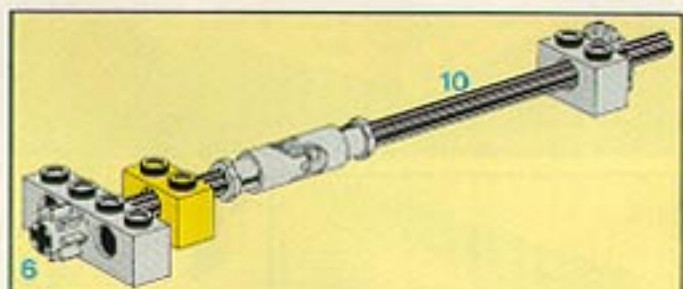

**7**

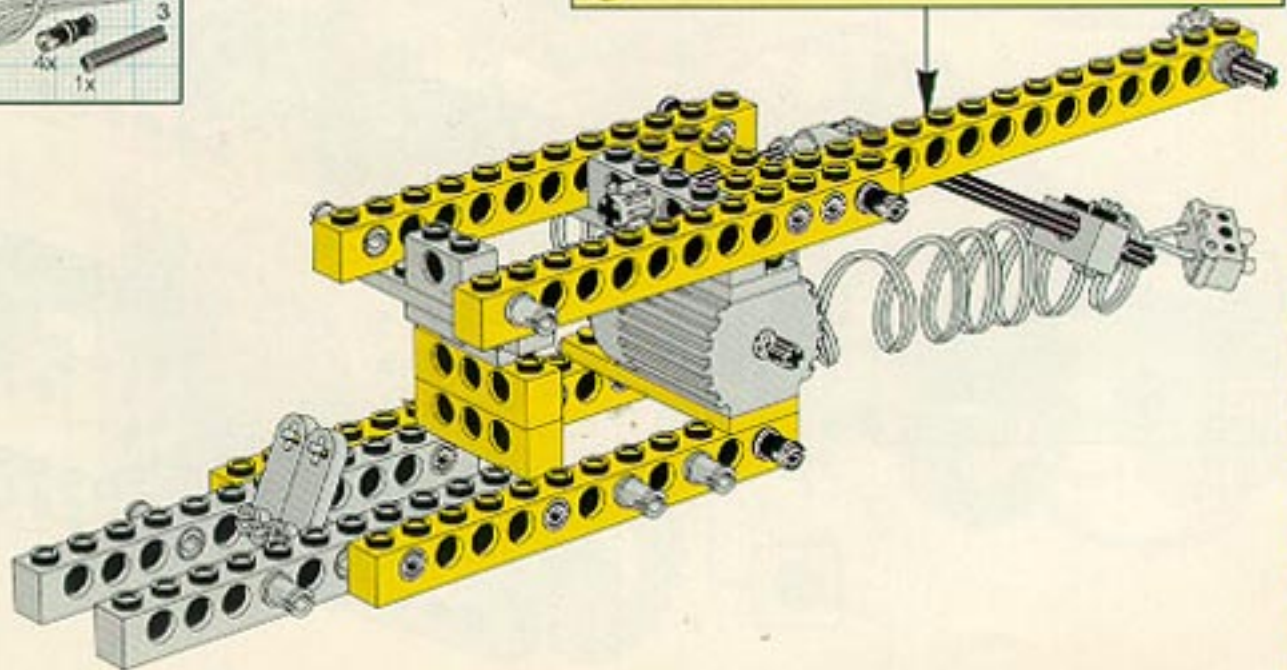
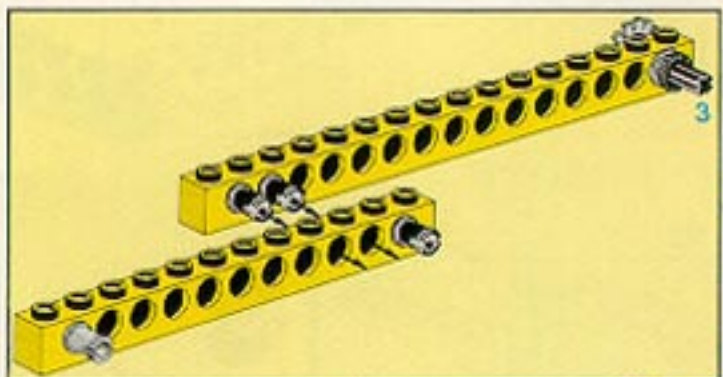

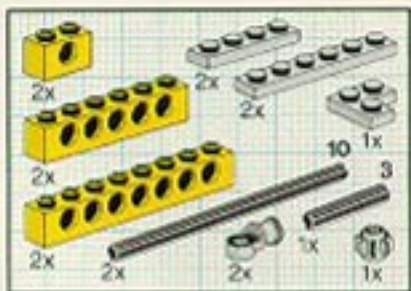

8

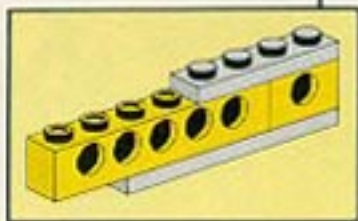
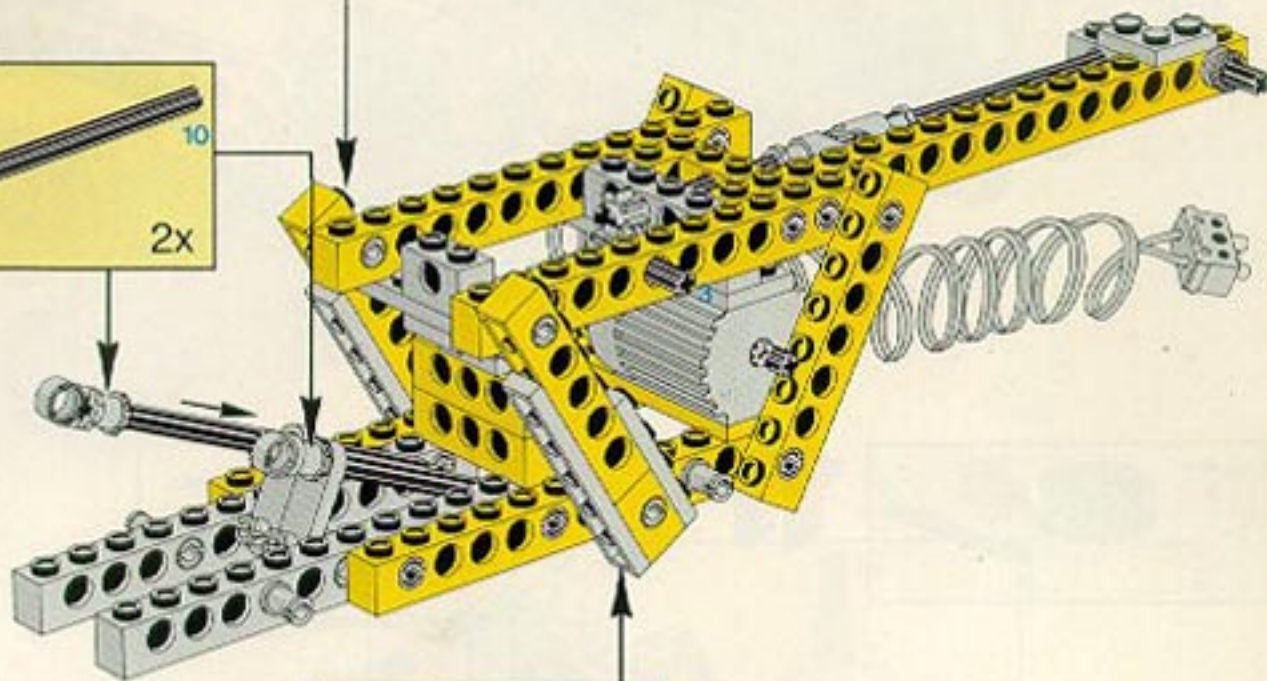
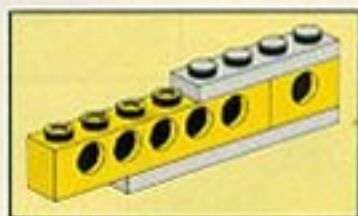

9

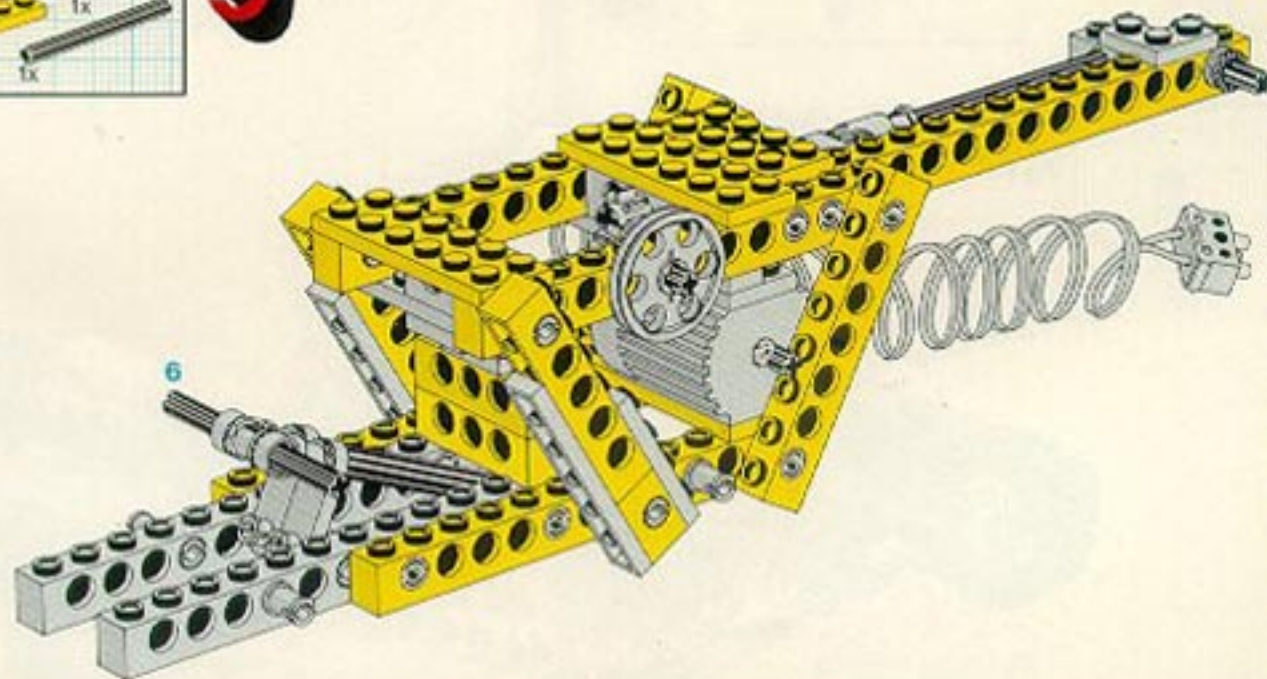

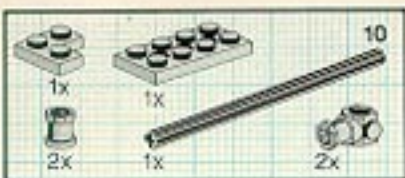

**10**

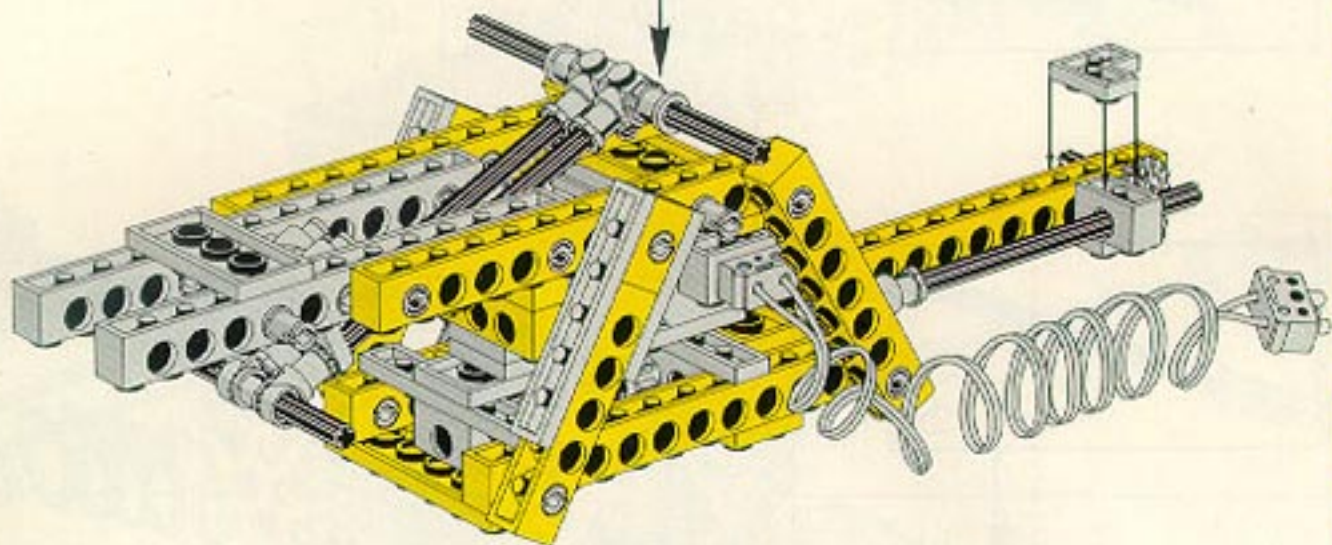
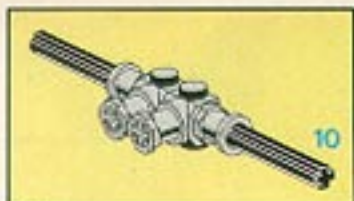

**11**

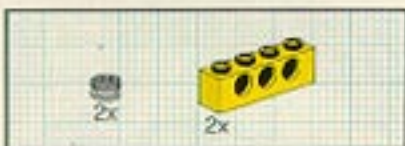
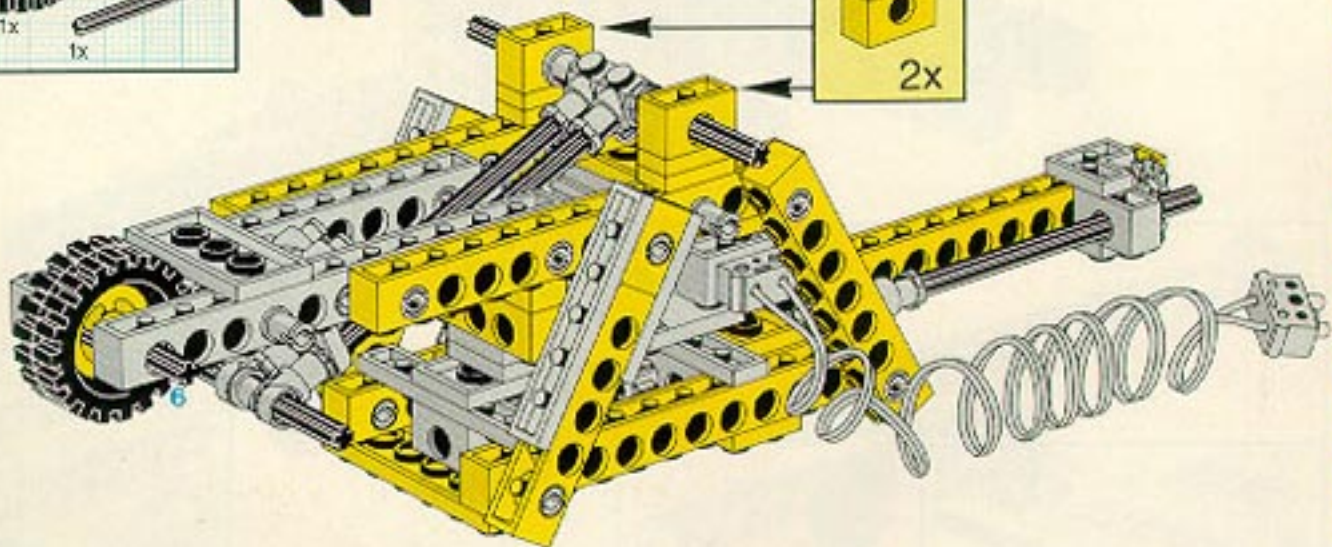

**12**

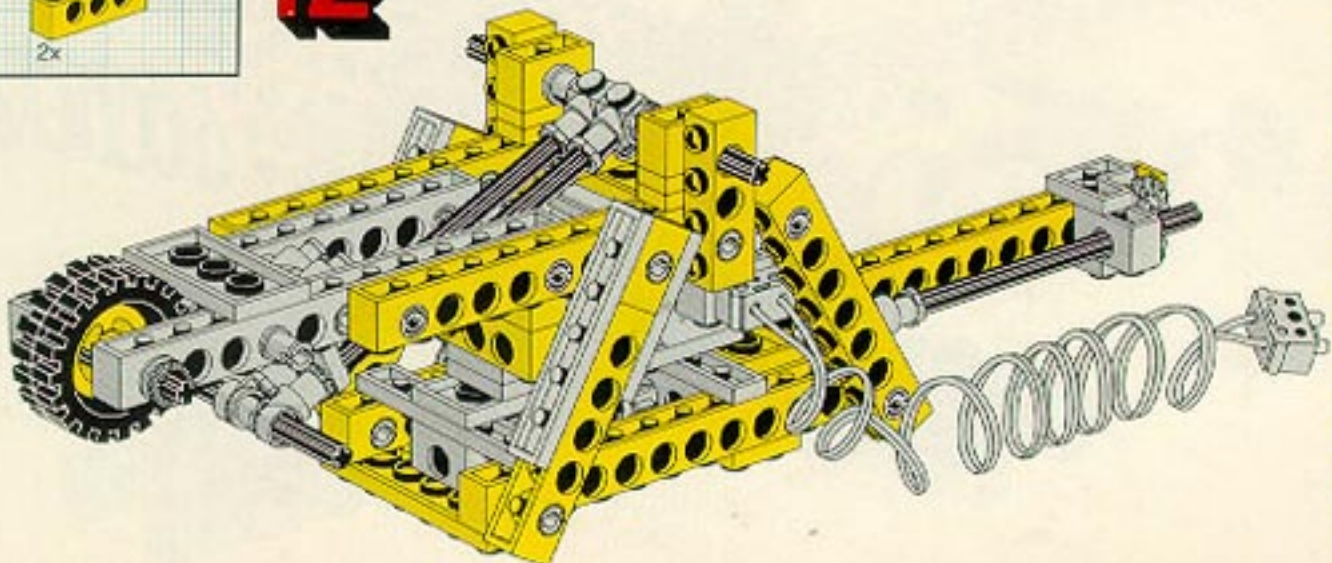

# 13

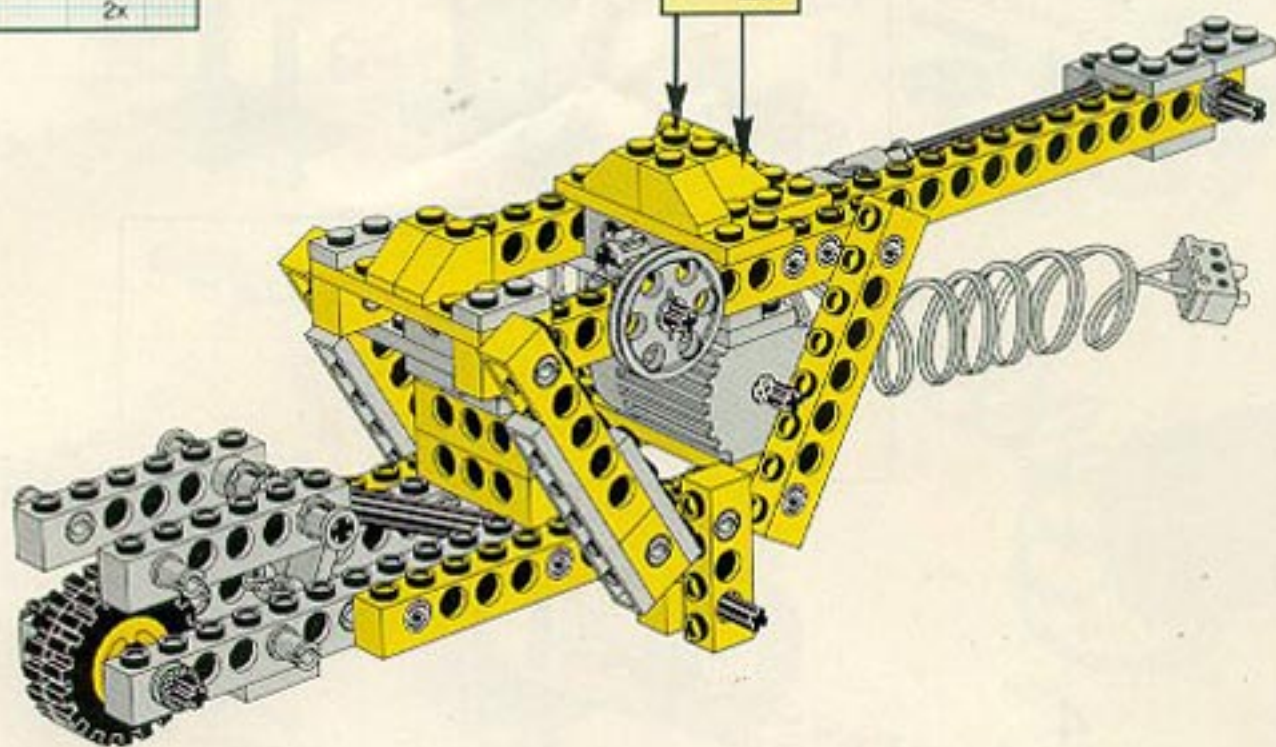
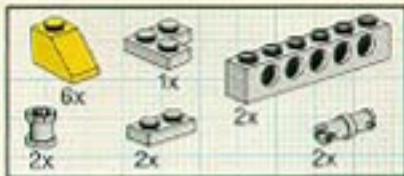

# 14

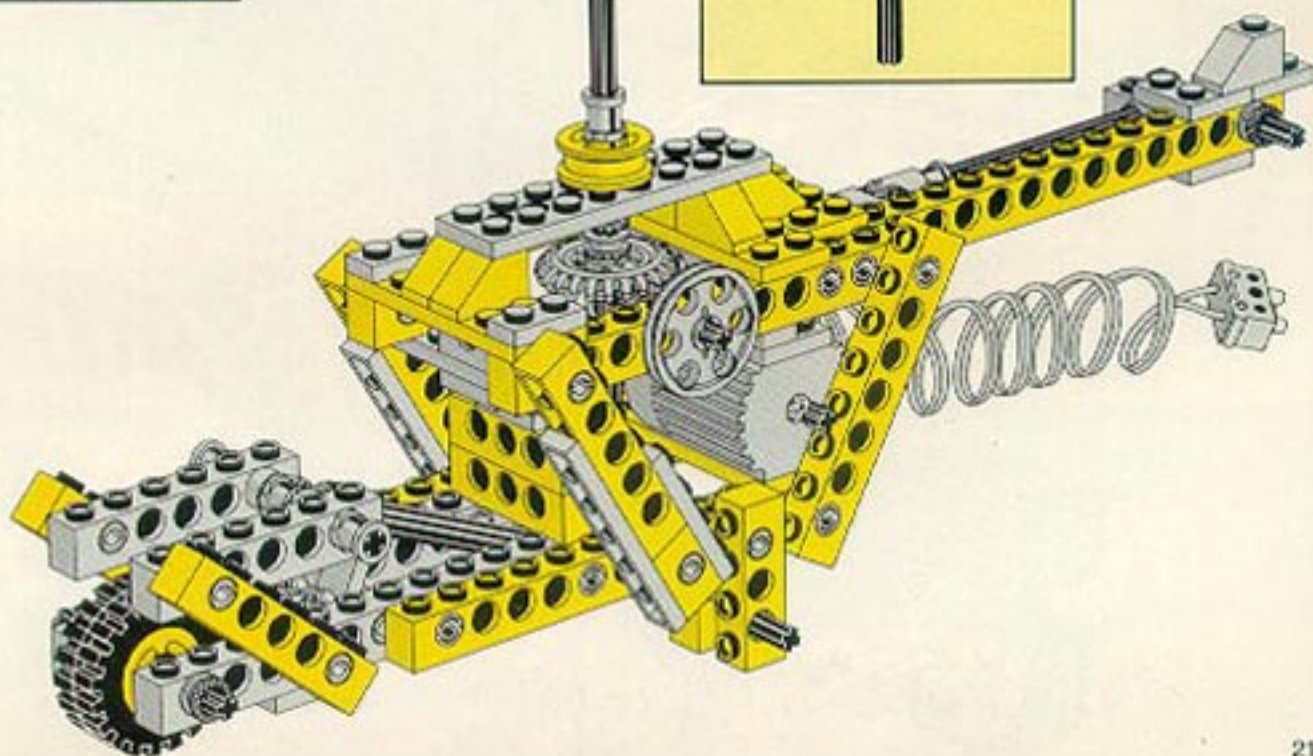
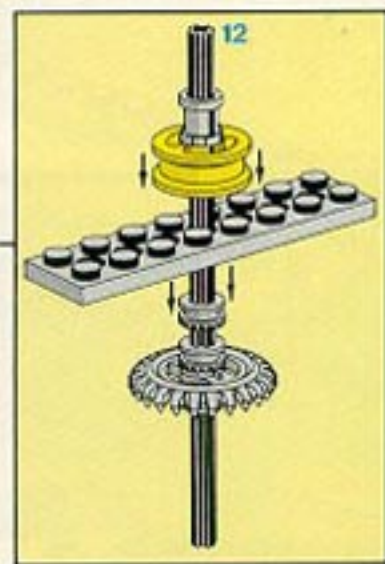
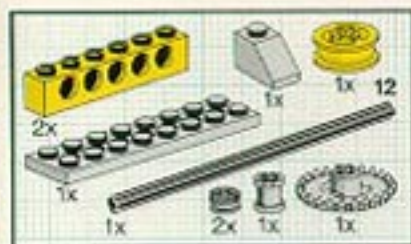

# 15

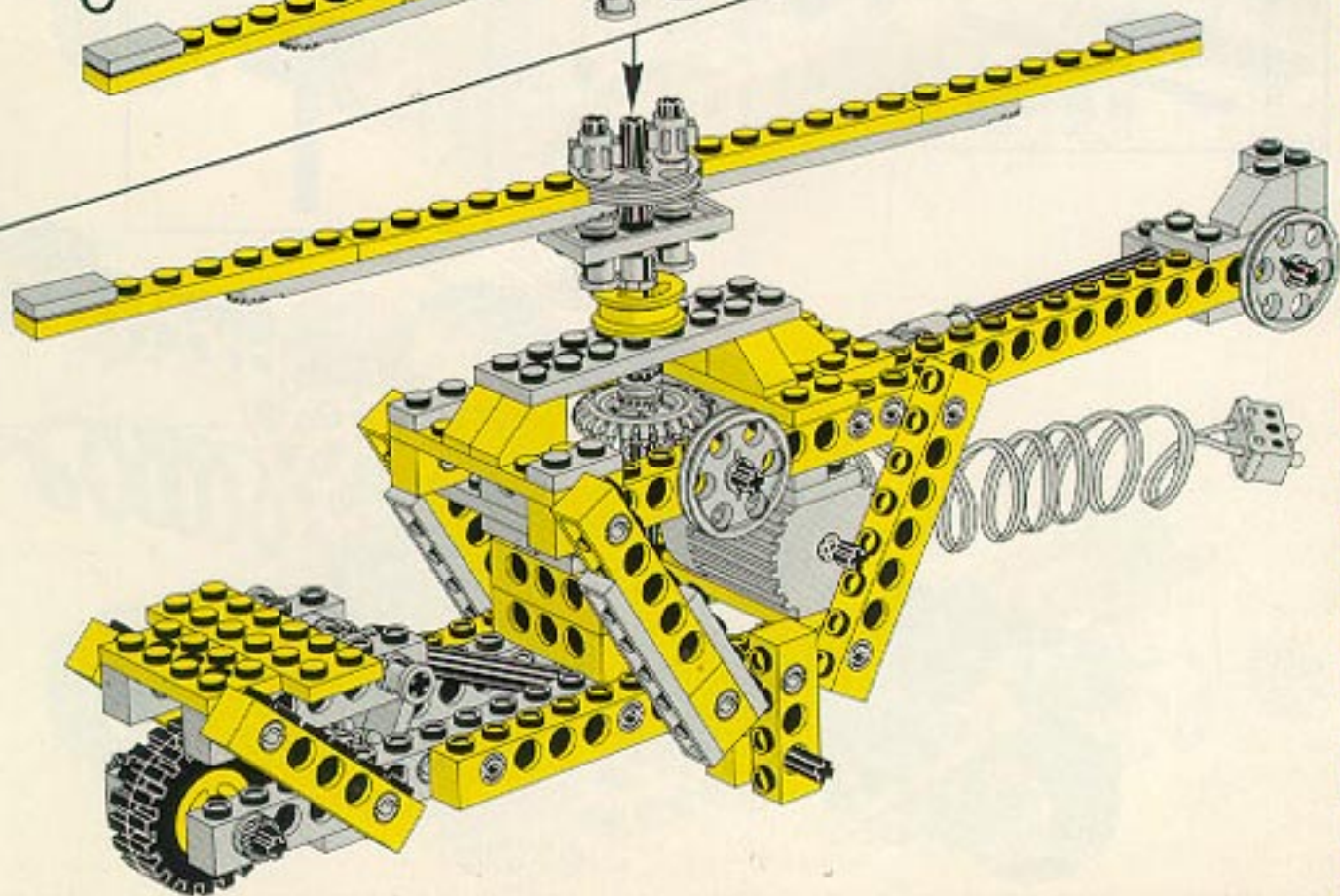
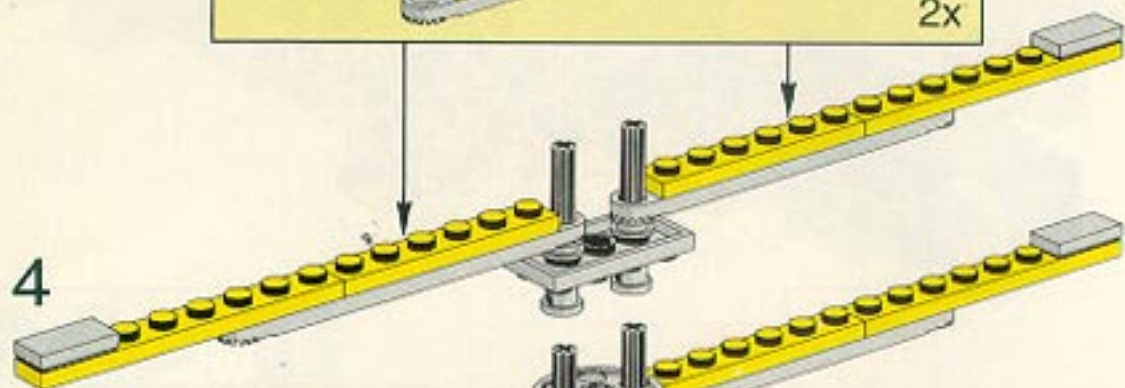
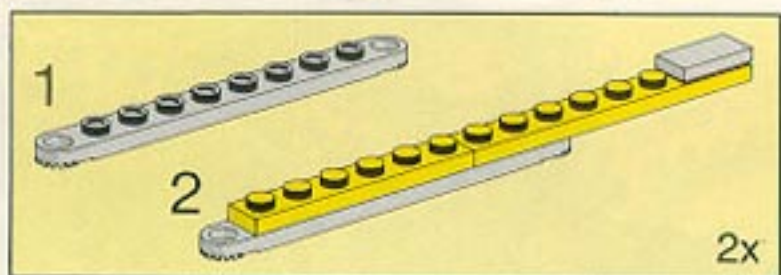
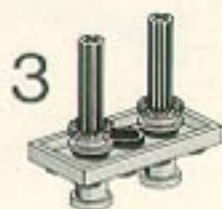
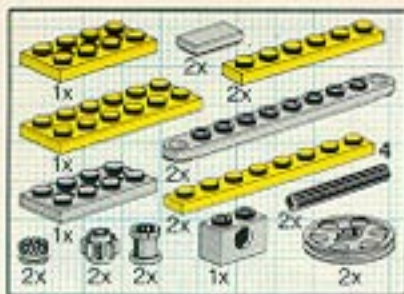



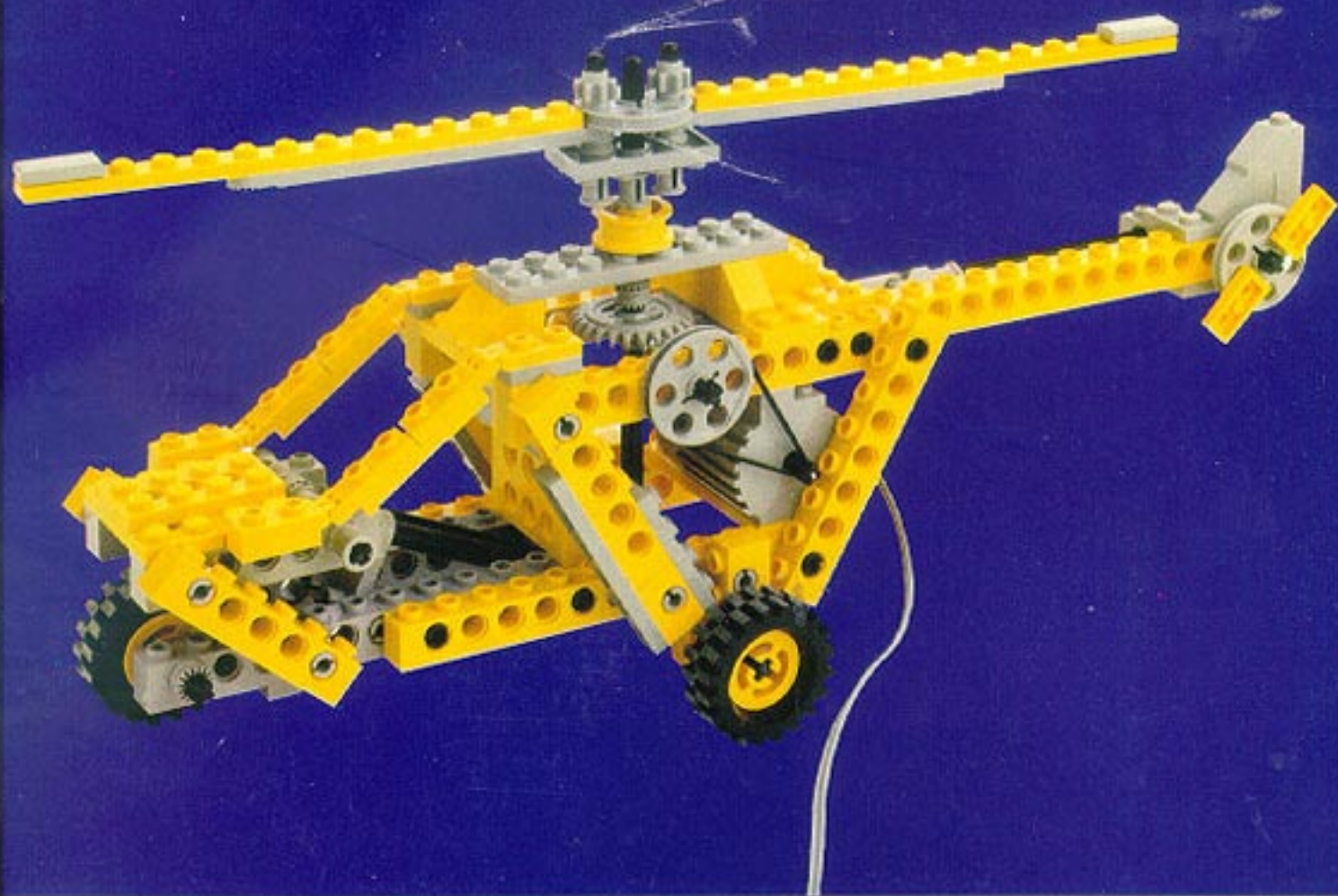















Image	Qty	Item No	Description	MID
<b>Regular Items:</b>				
<b>Parts:</b>				
+  *	1	<a href="#">4350c02</a> (inv)	<b>Light Gray Electric 4.5V 3 C-Cell Battery Box with Switch 4 x 24</b> <a href="#">Catalog: Parts: Electric, Battery Box</a> Part Color Code Missing	<a href="#">PG</a>
+  *	2	<a href="#">766c01</a> (inv)	<b>Light Gray Electric, Connector, 2-Way Male Squared Narrow Long with Center Post</b> <a href="#">Catalog: Parts: Electric, Wire &amp; Connector</a> Part Color Code Missing	<a href="#">PG</a>
+  *	1	<a href="#">6216m2</a>	<b>Light Gray Electric, Motor 4.5V Type 2 for 2-prong connectors WITH middle pin</b> <a href="#">Catalog: Parts: Electric, Motor</a> Part Color Code Missing	<a href="#">PG</a>
+  *	1	<a href="#">x466</a>	<b>Light Gray Electric, Wire 12V / 4.5V with two Leads, unspecified length</b> <a href="#">Catalog: Parts: Electric, Wire &amp; Connector</a> Part Color Code Missing	<a href="#">PG</a>
+  *	4	<a href="#">4276</a>	<b>Yellow Hinge Plate 1 x 2 with 2 Fingers</b> <a href="#">Catalog: Parts: Hinge</a> Part Color Code Missing	<a href="#">PG</a>
+  *	4	<a href="#">4275</a>	<b>Yellow Hinge Plate 1 x 2 with 3 Fingers</b> <a href="#">Catalog: Parts: Hinge</a> Part Color Code Missing	<a href="#">PG</a>
+  *	4	<a href="#">3023</a>	<b>Light Gray Plate 1 x 2</b> <a href="#">Catalog: Parts: Plate</a> 302302	<a href="#">PG</a>
+  *	6	<a href="#">3023</a>	<b>Yellow Plate 1 x 2</b> <a href="#">Catalog: Parts: Plate</a> 302324	<a href="#">PG</a>
+  *	2	<a href="#">3710</a>	<b>Light Gray Plate 1 x 4</b> <a href="#">Catalog: Parts: Plate</a> 371002	<a href="#">PG</a>
+  *	2	<a href="#">3710</a>	<b>Yellow Plate 1 x 4</b> <a href="#">Catalog: Parts: Plate</a> 371024	<a href="#">PG</a>
+  *	4	<a href="#">3666</a>	<b>Light Gray Plate 1 x 6</b> <a href="#">Catalog: Parts: Plate</a> 366602	<a href="#">PG</a>

+



\*

2

[3666](#)

**Yellow Plate 1 x 6**

[Catalog](#): [Parts](#): [Plate](#)  
366624

[PG](#)

+



\*

2

[3460](#)

**Yellow Plate 1 x 8**

[Catalog](#): [Parts](#): [Plate](#)  
346024

[PG](#)

+



\*

4

[2420](#)

**Light Gray Plate 2 x 2 Corner**

[Catalog](#): [Parts](#): [Plate](#)  
242002

[PG](#)

+



\*

4

[3795](#)

**Yellow Plate 2 x 6**

[Catalog](#): [Parts](#): [Plate](#)  
379524

[PG](#)

+



\*

1

[x264](#)

**Black Rubber Band Large (Square Cross Section)**

[Catalog](#): [Parts](#): [Rubber Band & Belt](#)  
Part Color Code Missing

[PG](#)

+



\*

2

[x137](#)

**Black Rubber Band Medium (Square Cross Section) Thin Cut**

[Catalog](#): [Parts](#): [Rubber Band & Belt](#)  
Part Color Code Missing

[PG](#)

+



\*

2

[3040](#)

**Light Gray Slope 45 2 x 1**

[Catalog](#): [Parts](#): [Slope](#)  
4121933

[PG](#)

+



\*

6

[3040](#)

**Yellow Slope 45 2 x 1**

[Catalog](#): [Parts](#): [Slope](#)  
304024 or 4121965

[PG](#)

+



\*

1

[x77](#)

**Black String, Cord (Undetermined Type)**

[Catalog](#): [Parts](#): [String](#)  
Part Color Code Missing

[PG](#)

+



\*

8

[3713](#)

**Light Gray Technic Bush**

[Catalog](#): [Parts](#): [Technic](#)  
4125313

[PG](#)

+



\*

10

[4265a](#)

**Light Gray Technic Bush 1/2 Toothed Type I**

[Catalog](#): [Parts](#): [Technic](#)  
Part Color Code Missing

[PG](#)

+



\*













3













[4185](#)













**Light Gray Technic Wedge Belt Wheel (Pulley)**

[Catalog](#): [Parts](#): [Technic](#)  
4100502

[PG](#)

+	 *	2	<a href="#">4519</a>	<b>Black Technic, Axle 3</b> <a href="#">Catalog:</a> <a href="#">Parts:</a> <a href="#">Technic, Axle</a> 451926	<a href="#">PG</a>
+	 *	2	<a href="#">3705</a>	<b>Black Technic, Axle 4</b> <a href="#">Catalog:</a> <a href="#">Parts:</a> <a href="#">Technic, Axle</a> 370526	<a href="#">PG</a>
+	 *	4	<a href="#">3706</a>	<b>Black Technic, Axle 6</b> <a href="#">Catalog:</a> <a href="#">Parts:</a> <a href="#">Technic, Axle</a> 370626	<a href="#">PG</a>
+	 *	2	<a href="#">3707</a>	<b>Black Technic, Axle 8</b> <a href="#">Catalog:</a> <a href="#">Parts:</a> <a href="#">Technic, Axle</a> 370726	<a href="#">PG</a>
+	 *	4	<a href="#">3737</a>	<b>Black Technic, Axle 10</b> <a href="#">Catalog:</a> <a href="#">Parts:</a> <a href="#">Technic, Axle</a> 373726	<a href="#">PG</a>
+	 *	2	<a href="#">3708</a>	<b>Black Technic, Axle 12</b> <a href="#">Catalog:</a> <a href="#">Parts:</a> <a href="#">Technic, Axle</a> 370826	<a href="#">PG</a>
+	 *	4	<a href="#">3651</a>	<b>Light Gray Technic, Axle and Pin Connector</b> <a href="#">Catalog:</a> <a href="#">Parts:</a> <a href="#">Technic, Connector</a> Part Color Code Missing	<a href="#">PG</a>
+	 *	2	<a href="#">4273</a>	<b>Light Gray Technic, Axle and Pin Connector Toggle Joint Toothed</b> <a href="#">Catalog:</a> <a href="#">Parts:</a> <a href="#">Technic, Connector</a> Part Color Code Missing	<a href="#">PG</a>
+	 *	4	<a href="#">3749</a>	<b>Light Gray Technic, Axle Pin without Friction Ridges Lengthwise</b> <a href="#">Catalog:</a> <a href="#">Parts:</a> <a href="#">Technic, Axle</a> 4184168 or 656202	<a href="#">PG</a>
+	 *	4	<a href="#">3700</a>	<b>Light Gray Technic, Brick 1 x 2 with Hole</b> <a href="#">Catalog:</a> <a href="#">Parts:</a> <a href="#">Technic, Brick</a> 370002	<a href="#">PG</a>
+	 *	6	<a href="#">3700</a>	<b>Yellow Technic, Brick 1 x 2 with Hole</b> <a href="#">Catalog:</a> <a href="#">Parts:</a> <a href="#">Technic, Brick</a> 370024	<a href="#">PG</a>
+	 *	2	<a href="#">3701</a>	<b>Light Gray Technic, Brick 1 x 4 with Holes</b> <a href="#">Catalog:</a> <a href="#">Parts:</a> <a href="#">Technic, Brick</a> 370102	<a href="#">PG</a>

+	 *	4	<a href="#">3701</a>	<b>Yellow Technic, Brick 1 x 4 with Holes</b> <a href="#">Catalog:</a> <a href="#">Parts:</a> <a href="#">Technic, Brick</a> 370124	<a href="#">PG</a>
+	 *	2	<a href="#">3894</a>	<b>Light Gray Technic, Brick 1 x 6 with Holes</b> <a href="#">Catalog:</a> <a href="#">Parts:</a> <a href="#">Technic, Brick</a> 389402	<a href="#">PG</a>
+	 *	4	<a href="#">3894</a>	<b>Yellow Technic, Brick 1 x 6 with Holes</b> <a href="#">Catalog:</a> <a href="#">Parts:</a> <a href="#">Technic, Brick</a> 389424	<a href="#">PG</a>
+	 *	2	<a href="#">3702</a>	<b>Yellow Technic, Brick 1 x 8 with Holes</b> <a href="#">Catalog:</a> <a href="#">Parts:</a> <a href="#">Technic, Brick</a> 370224	<a href="#">PG</a>
+	 *	2	<a href="#">3895</a>	<b>Light Gray Technic, Brick 1 x 12 with Holes</b> <a href="#">Catalog:</a> <a href="#">Parts:</a> <a href="#">Technic, Brick</a> 4195006	<a href="#">PG</a>
+	 *	4	<a href="#">3895</a>	<b>Yellow Technic, Brick 1 x 12 with Holes</b> <a href="#">Catalog:</a> <a href="#">Parts:</a> <a href="#">Technic, Brick</a> 6262393 or 389524	<a href="#">PG</a>
+	 *	2	<a href="#">3703</a>	<b>Yellow Technic, Brick 1 x 16 with Holes</b> <a href="#">Catalog:</a> <a href="#">Parts:</a> <a href="#">Technic, Brick</a> 370324	<a href="#">PG</a>
+	 *	4	<a href="#">3647</a>	<b>Light Gray Technic, Gear 8 Tooth Type 1</b> <a href="#">Catalog:</a> <a href="#">Parts:</a> <a href="#">Technic, Gear</a> 364702	<a href="#">PG</a>
+	 *	2	<a href="#">4143</a>	<b>Light Gray Technic, Gear 14 Tooth Bevel</b> <a href="#">Catalog:</a> <a href="#">Parts:</a> <a href="#">Technic, Gear</a> Part Color Code Missing	<a href="#">PG</a>
+	 *	1	<a href="#">4019</a>	<b>Light Gray Technic, Gear 16 Tooth (First Version - 4 Round Holes)</b> <a href="#">Catalog:</a> <a href="#">Parts:</a> <a href="#">Technic, Gear</a> Part Color Code Missing	<a href="#">PG</a>
+	 *	2	<a href="#">x187</a>	<b>Light Gray Technic, Gear 24 Tooth (1st Version - 3 Axle Holes)</b> <a href="#">Catalog:</a> <a href="#">Parts:</a> <a href="#">Technic, Gear</a> Part Color Code Missing	<a href="#">PG</a>
+	 *	1	<a href="#">3650a</a>	<b>Light Gray Technic, Gear 24 Tooth Crown (1st Version - Not Reinforced)</b> <a href="#">Catalog:</a> <a href="#">Parts:</a> <a href="#">Technic, Gear</a> Part Color Code Missing	<a href="#">PG</a>

+	 *	1	<a href="#">3743</a>	<b>Light Gray Technic, Gear Rack 1 x 4</b> <a href="#">Catalog: Parts: Technic, Gear</a> <a href="#">374302</a>	<a href="#">PG</a>
+	 *	1	<a href="#">4716</a>	<b>Black Technic, Gear Worm Screw, Long</b> <a href="#">Catalog: Parts: Technic, Gear</a> <a href="#">6037533</a> or <a href="#">471626</a>	<a href="#">PG</a>
+	 *	10	<a href="#">4459</a>	<b>Black Technic, Pin with Friction Ridges Lengthwise WITHOUT Center Slots</b> <a href="#">Catalog: Parts: Technic, Pin</a> <a href="#">Part Color Code Missing</a>	<a href="#">PG</a>
+	 *	12	<a href="#">3673</a>	<b>Light Gray Technic, Pin without Friction Ridges Lengthwise</b> <a href="#">Catalog: Parts: Technic, Pin</a> <a href="#">4184166</a>	<a href="#">PG</a>
+	 *	3	<a href="#">2719</a>	<b>Light Gray Technic, Plate 1 x 10 with Toothed Ends</b> <a href="#">Catalog: Parts: Technic, Plate</a> <a href="#">Part Color Code Missing</a>	<a href="#">PG</a>
+	 *	2	<a href="#">3709b</a>	<b>Light Gray Technic, Plate 2 x 4 with 3 Holes</b> <a href="#">Catalog: Parts: Technic, Plate</a> <a href="#">370902</a>	<a href="#">PG</a>
+	 *	4	<a href="#">3709b</a>	<b>Yellow Technic, Plate 2 x 4 with 3 Holes</b> <a href="#">Catalog: Parts: Technic, Plate</a> <a href="#">370924</a>	<a href="#">PG</a>
+	 *	2	<a href="#">3738</a>	<b>Light Gray Technic, Plate 2 x 8 with 7 Holes</b> <a href="#">Catalog: Parts: Technic, Plate</a> <a href="#">373802</a>	<a href="#">PG</a>
+	 *	2	<a href="#">4261</a>	<b>Light Gray Technic, Steering Arm</b> <a href="#">Catalog: Parts: Technic, Steering</a> <a href="#">Part Color Code Missing</a>	<a href="#">PG</a>
+	 *	1	<a href="#">9244c01(inv)</a>	<b>Light Gray Technic, Universal Joint 4L</b> <a href="#">Catalog: Parts: Technic, Connector</a> <a href="#">Part Color Code Missing</a>	<a href="#">PG</a>
+	 *	2	<a href="#">3069b</a>	<b>Light Gray Tile 1 x 2 with Groove</b> <a href="#">Catalog: Parts: Tile</a> <a href="#">306902</a>	<a href="#">PG</a>
+	 *	6	<a href="#">2346</a>	<b>Black Tire 30 x 10.5 Offset Tread</b> <a href="#">Catalog: Parts: Tire &amp; Tread</a> <a href="#">234626</a>	<a href="#">PG</a>

+



\*

6

[3482](#)

**Yellow Wheel with Split Axle Hole**

[Catalog:](#) [Parts:](#) [Wheel](#)  
348224

[PG](#)

**Counterparts:**

+



\*

6

[3482c02\(inv\)](#)

**Yellow Wheel with Split Axle Hole with Black Tire 30 x 10.5  
Offset Tread (3482 / 2346)**

[Catalog:](#) [Parts:](#) [Wheel & Tire Assembly](#)  
Part Color Code Missing

[PG](#)

**Summary:**

Type	Unique Lots	Total Qty
<b>Regular Items:</b>		
Parts	60	196
<b>Counterparts:</b>		
Parts	1	6

**Source:**  
Instructions

[Admin](#) inventoried this Set on Mar 18, 2007, inventory last updated on Sep 21, 2019.