

Grapple from 42042

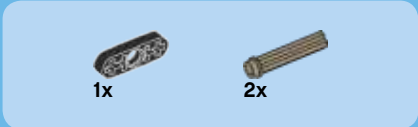

1

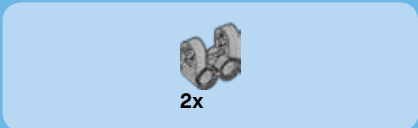

2

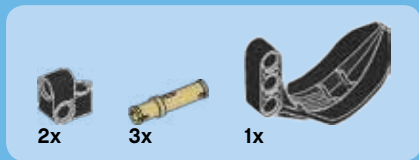
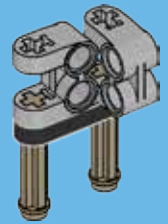

3

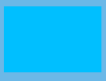
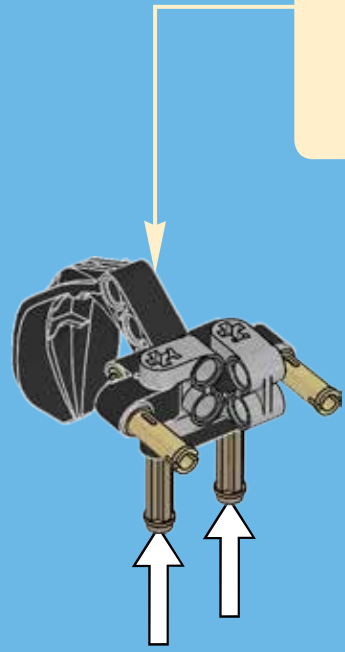
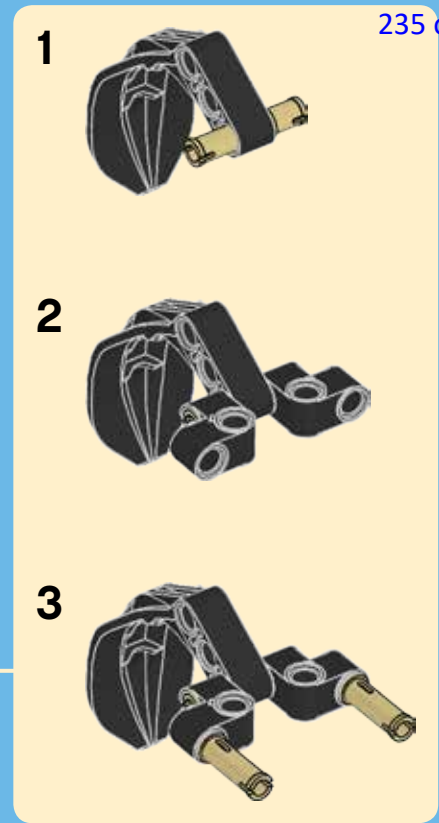

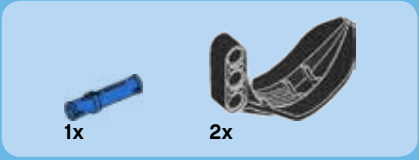

4

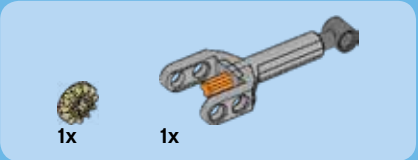
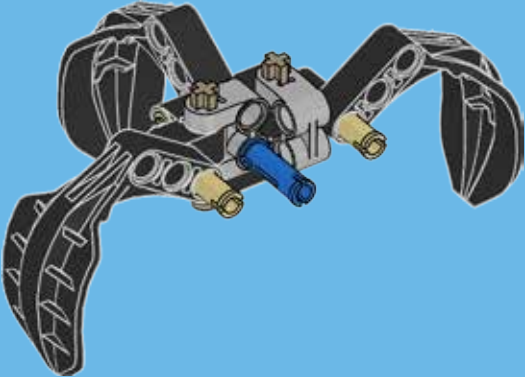

5

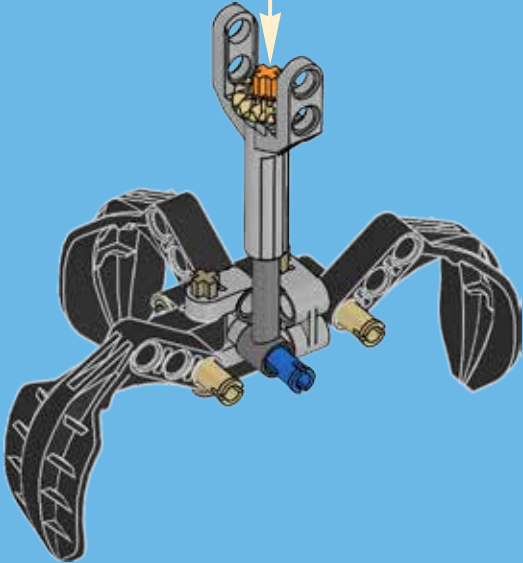
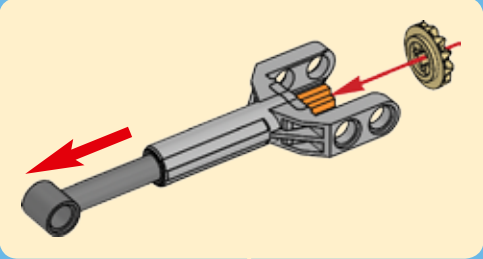

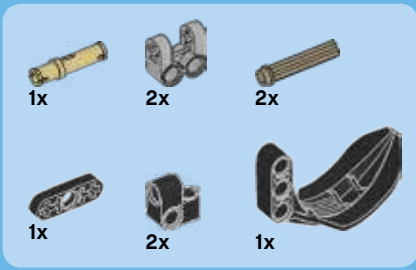

6

1



2

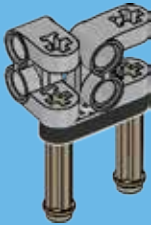

3

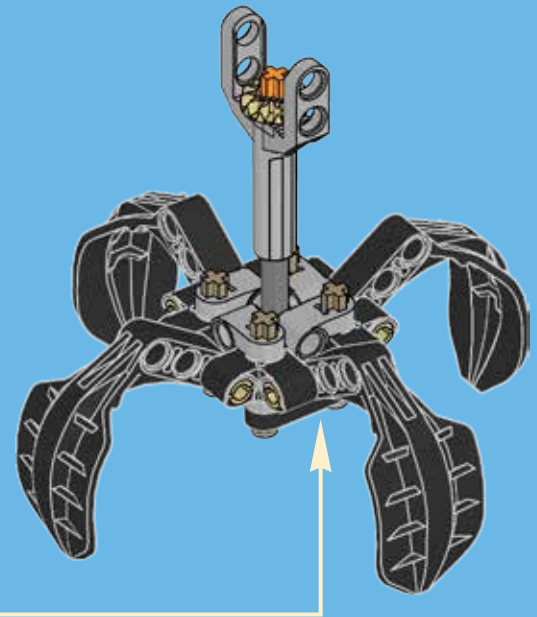
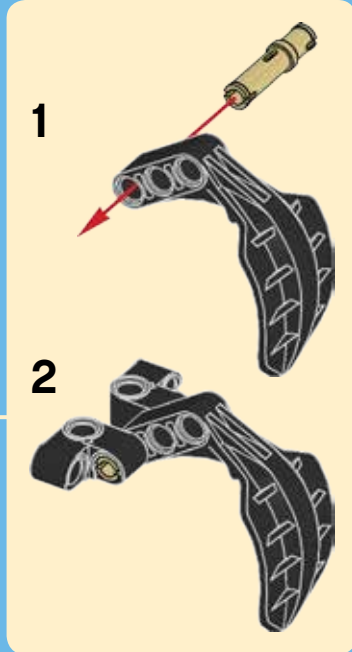
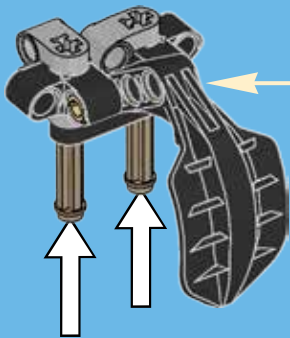



7

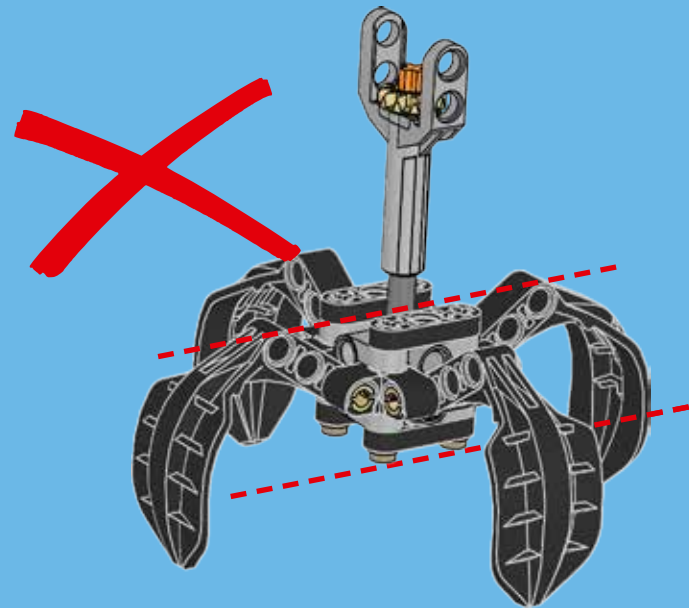
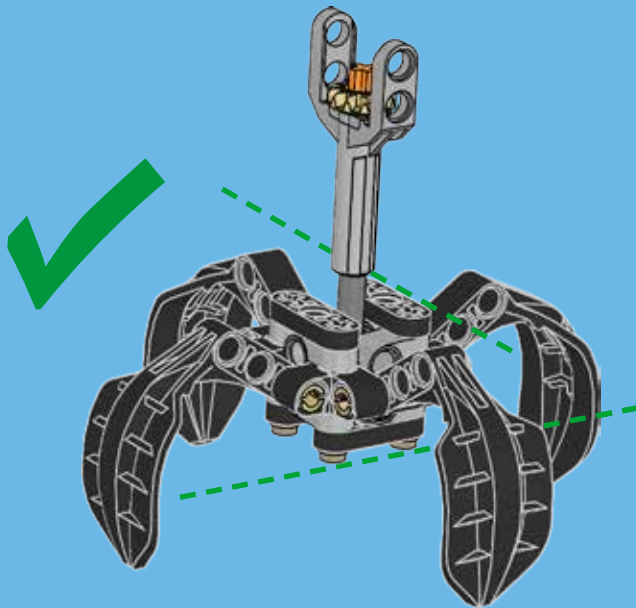

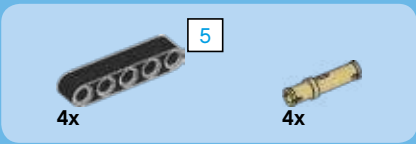

8

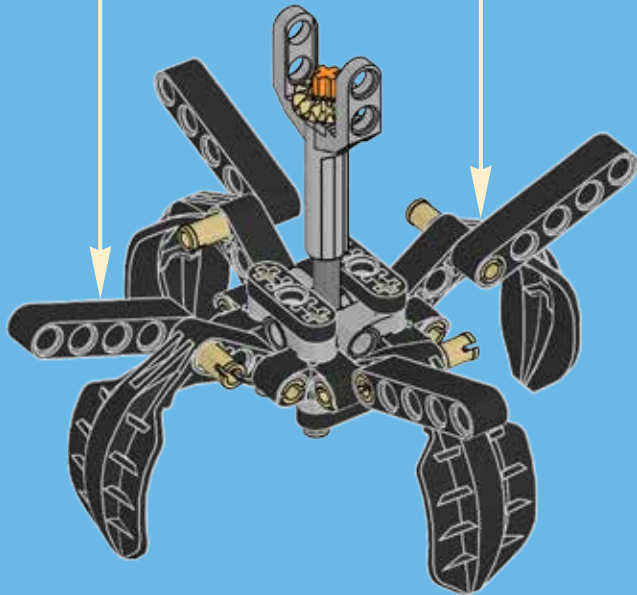

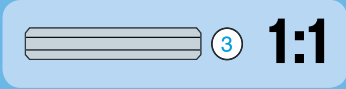
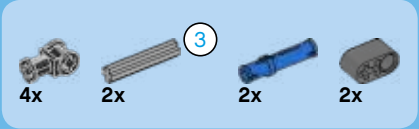

9

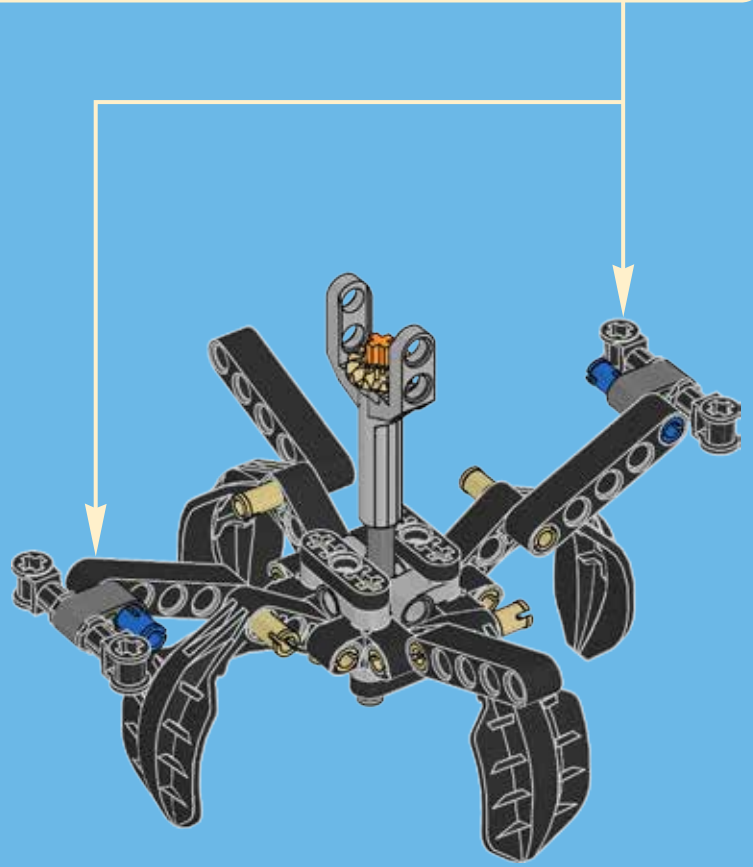
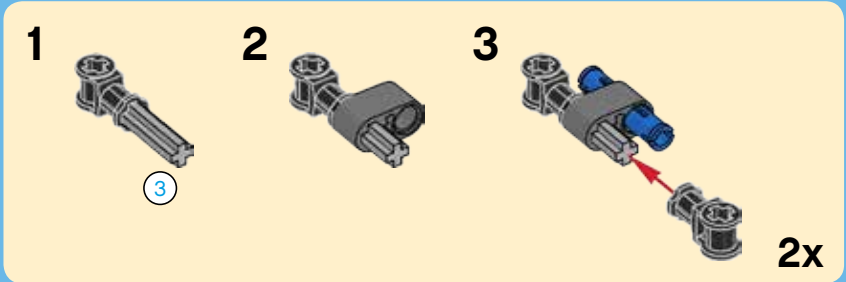

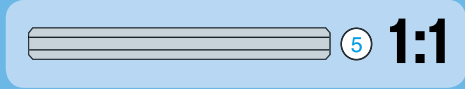
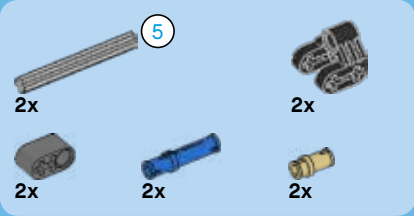

10

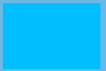
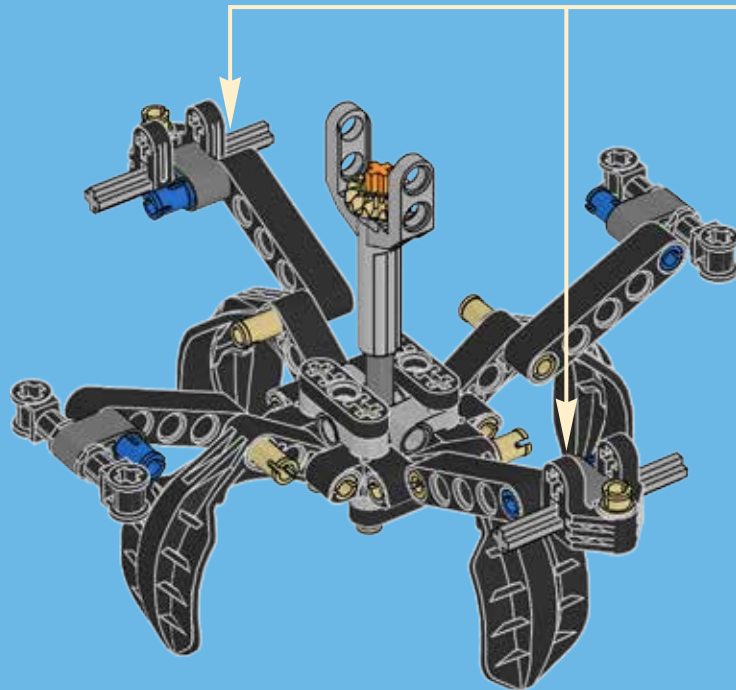
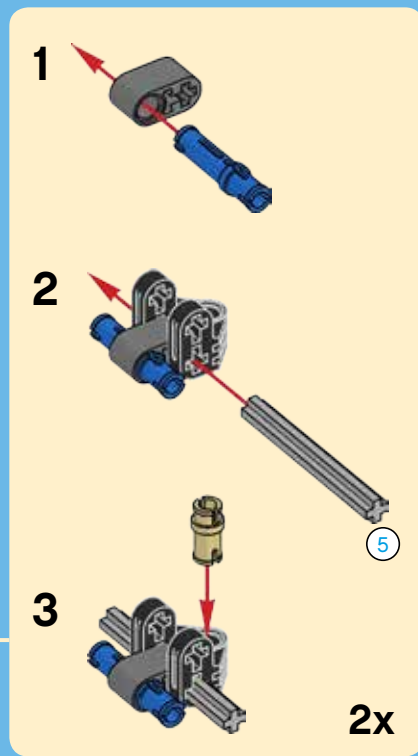

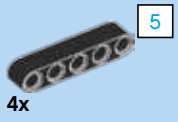

11

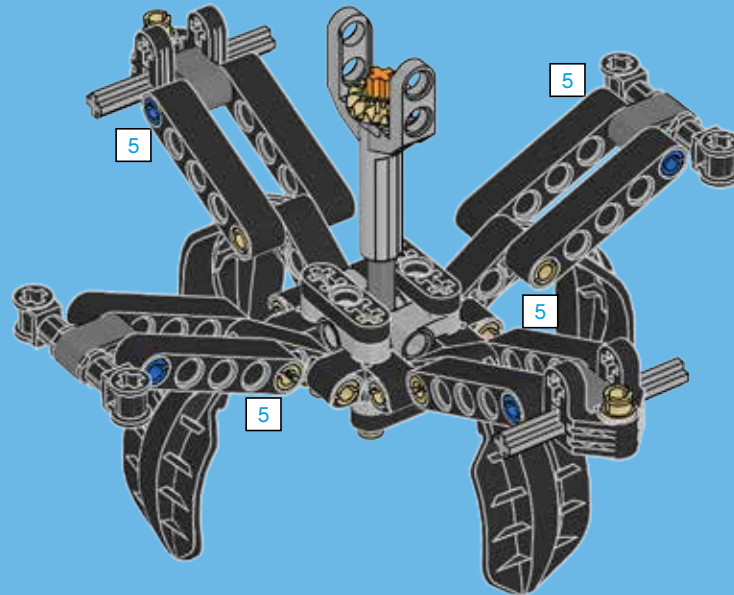

12

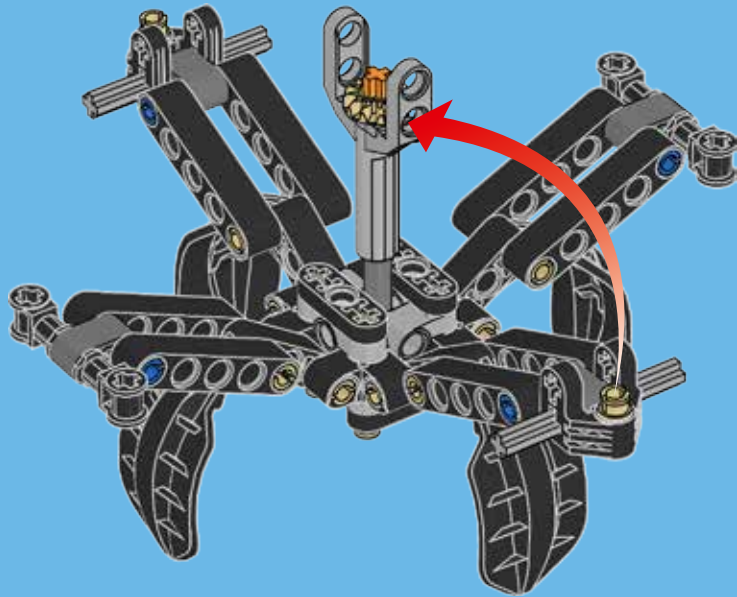

13

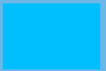
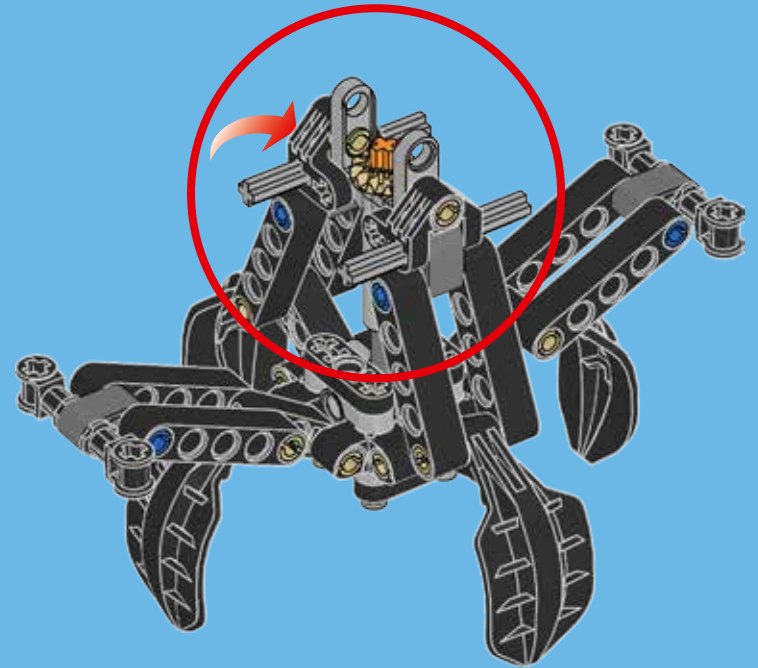



2x

14

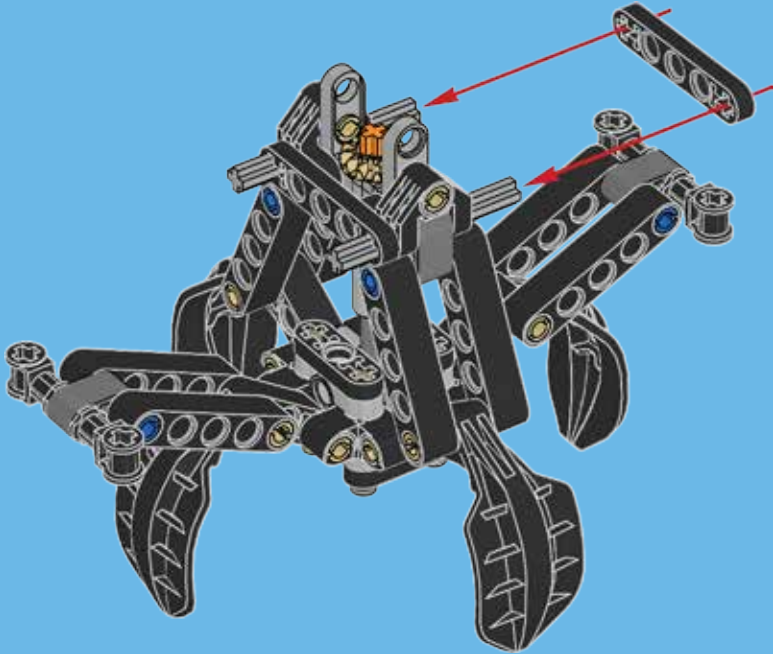

15

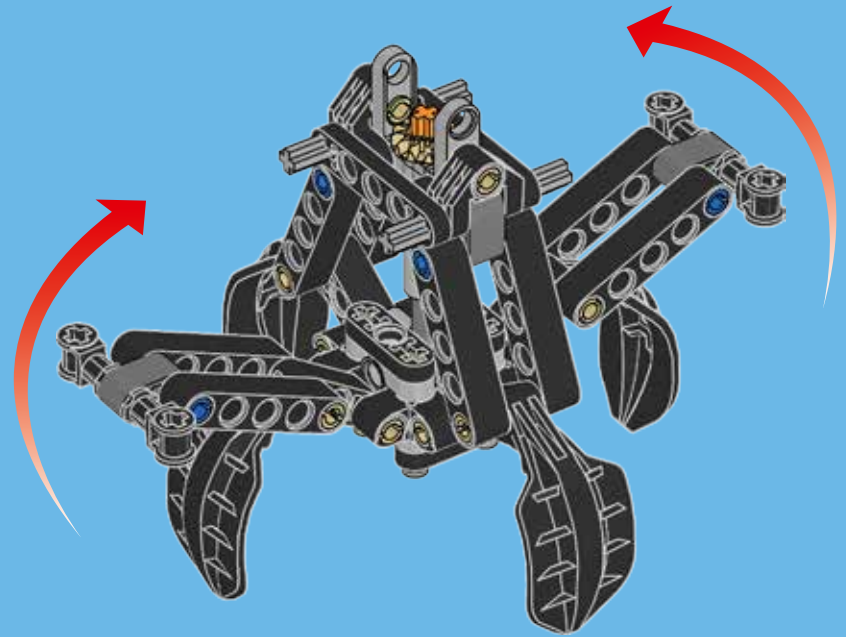

16

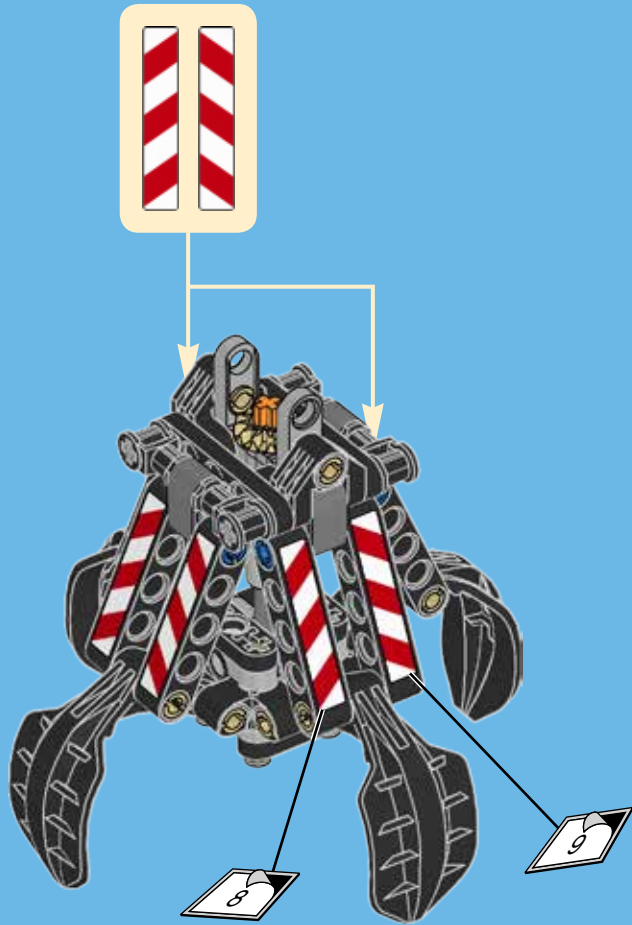

17

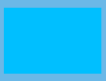
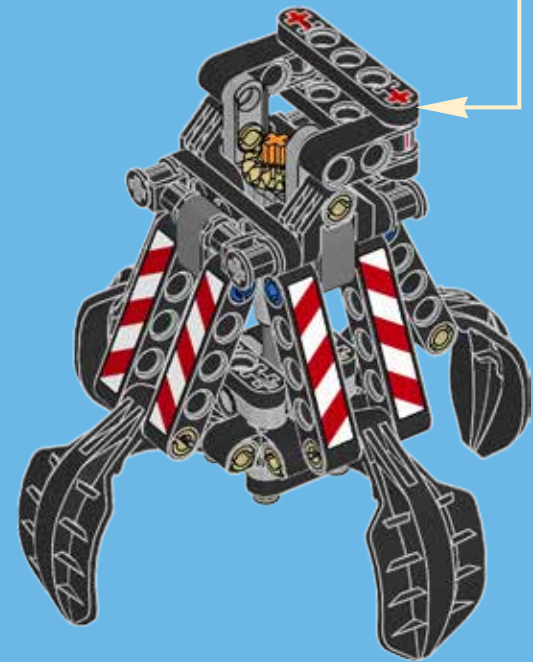
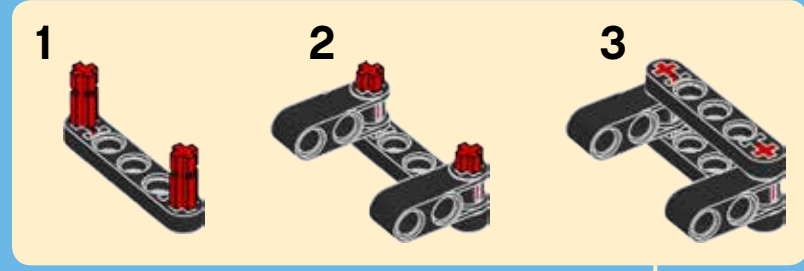
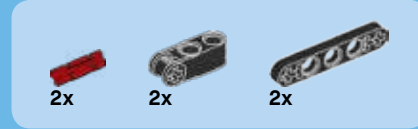

Clamshell grapple



same on the other clam shell





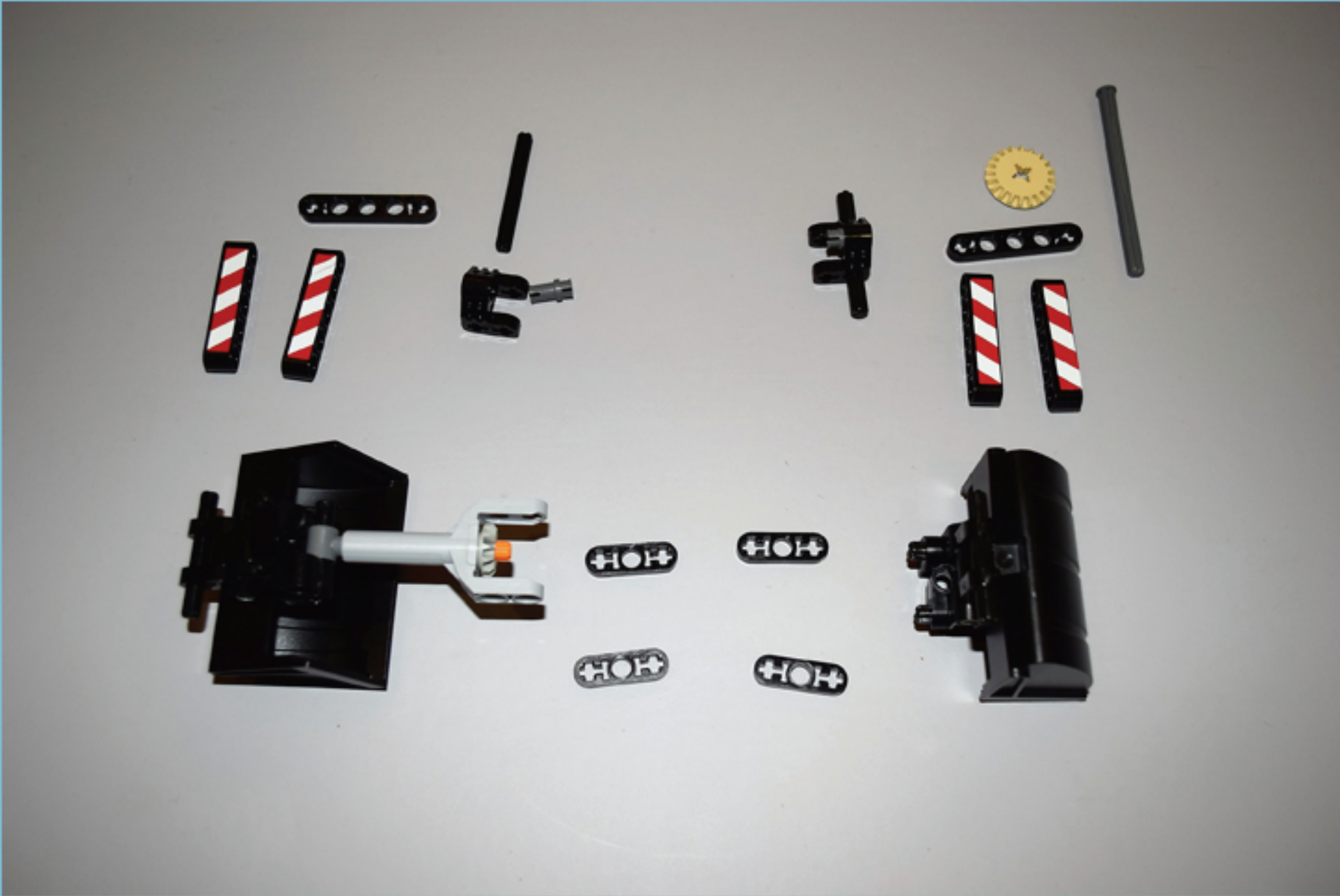

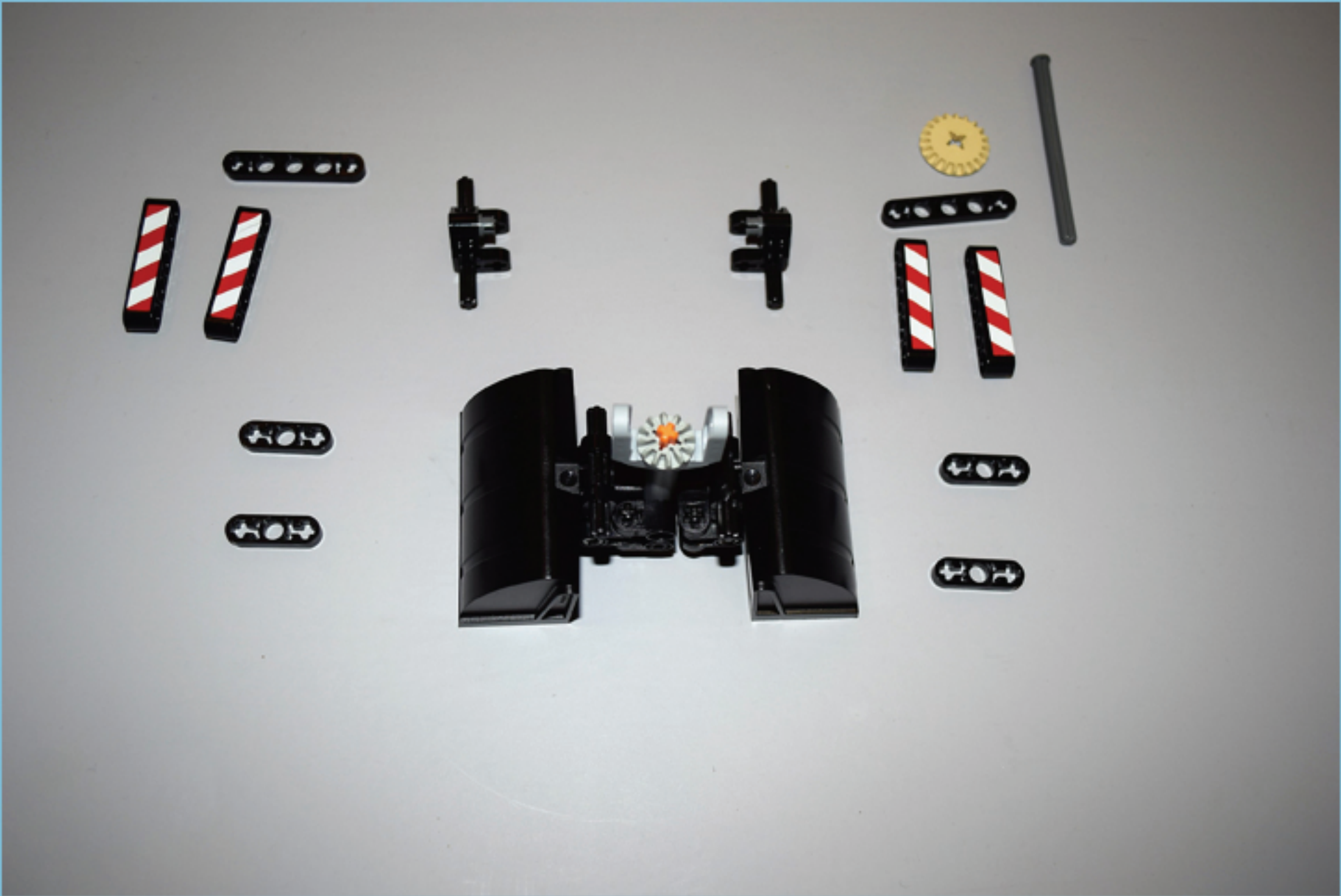

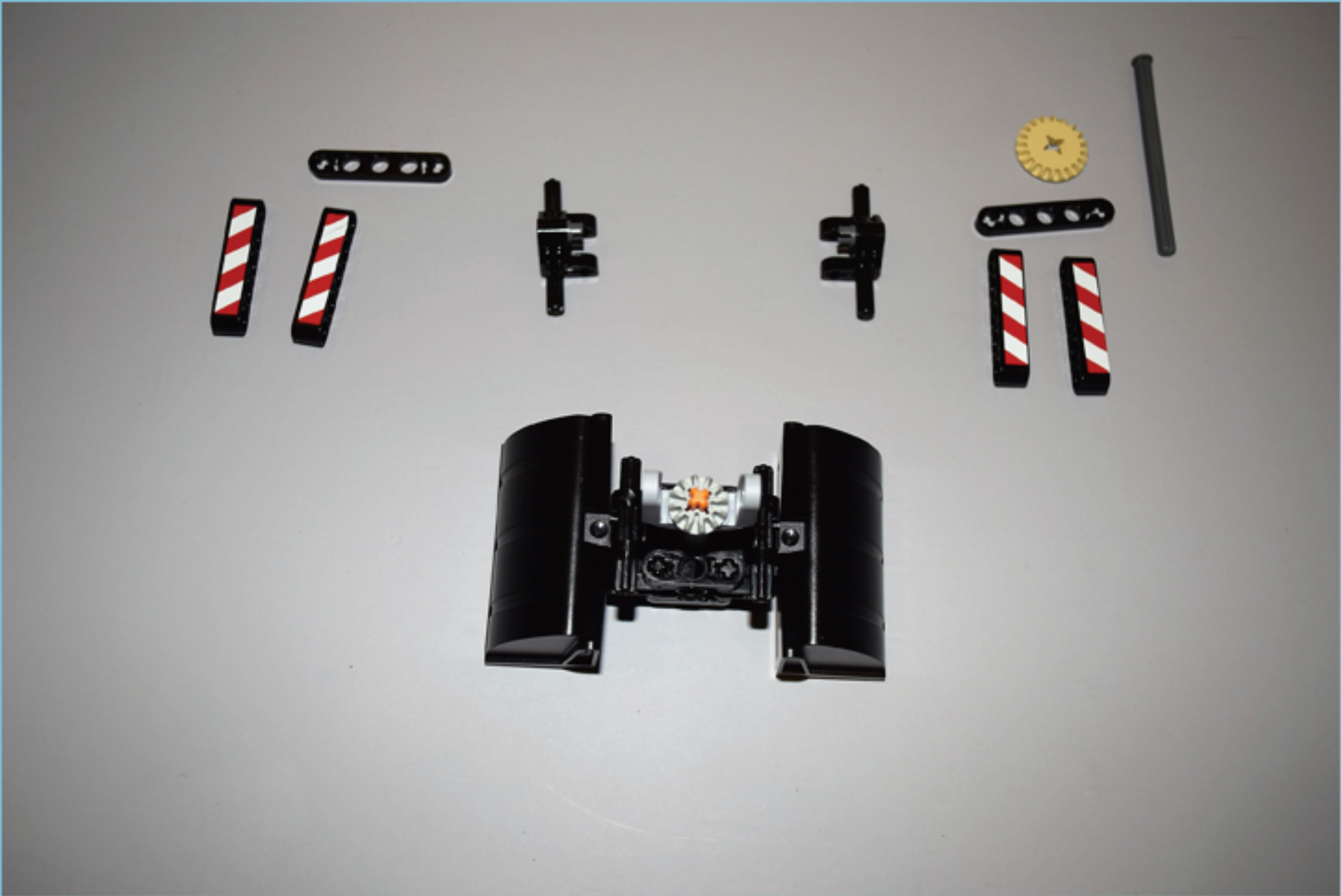

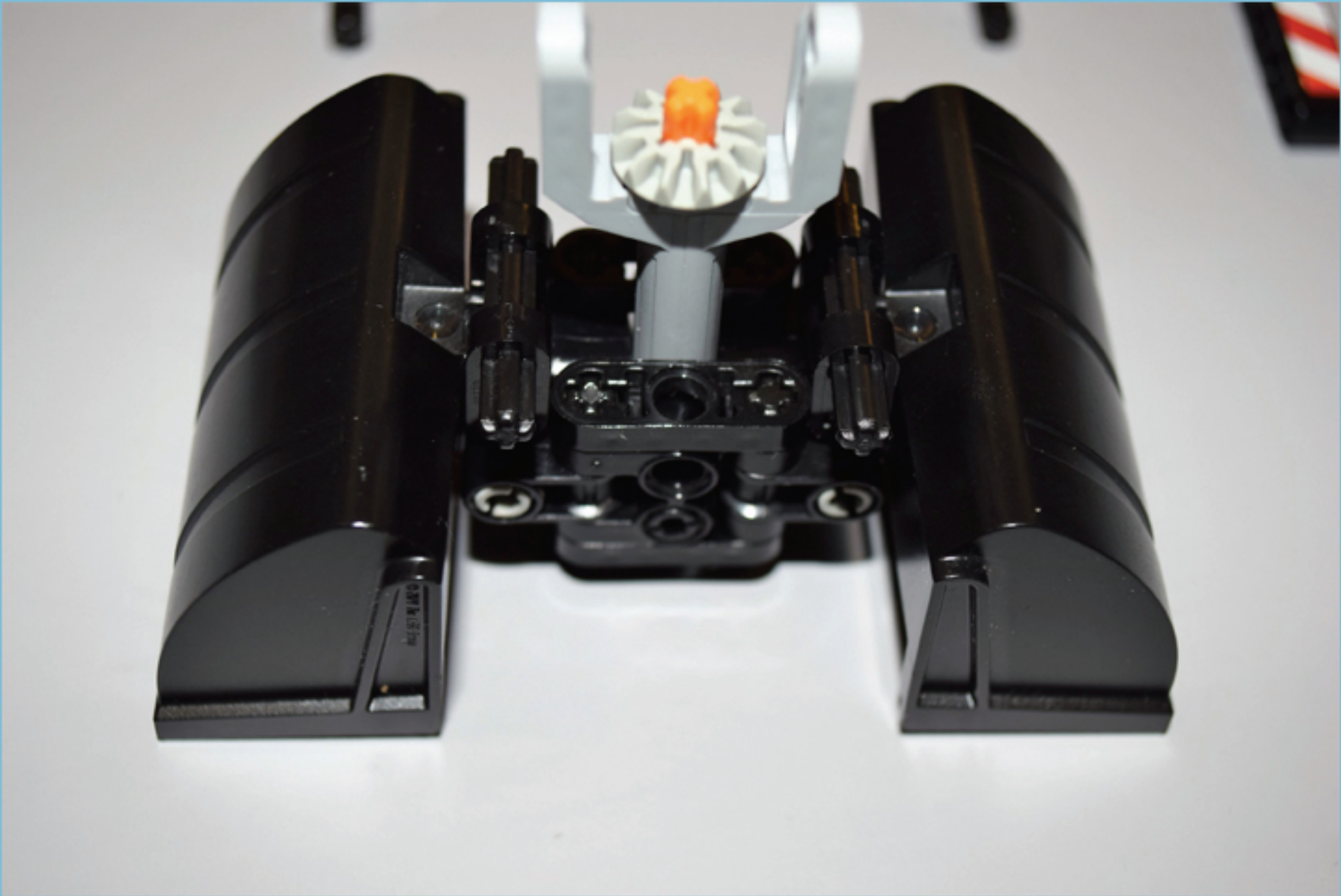

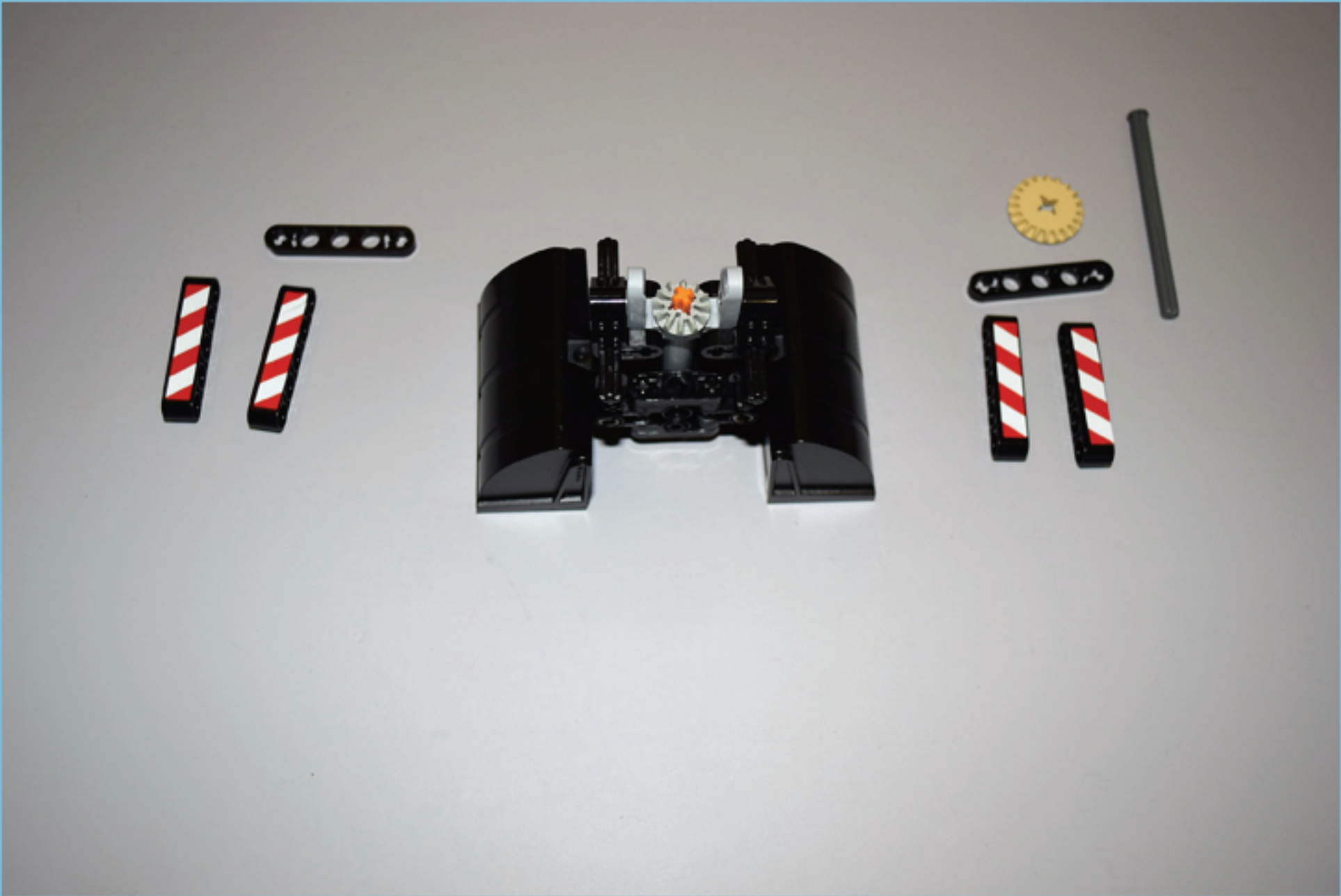



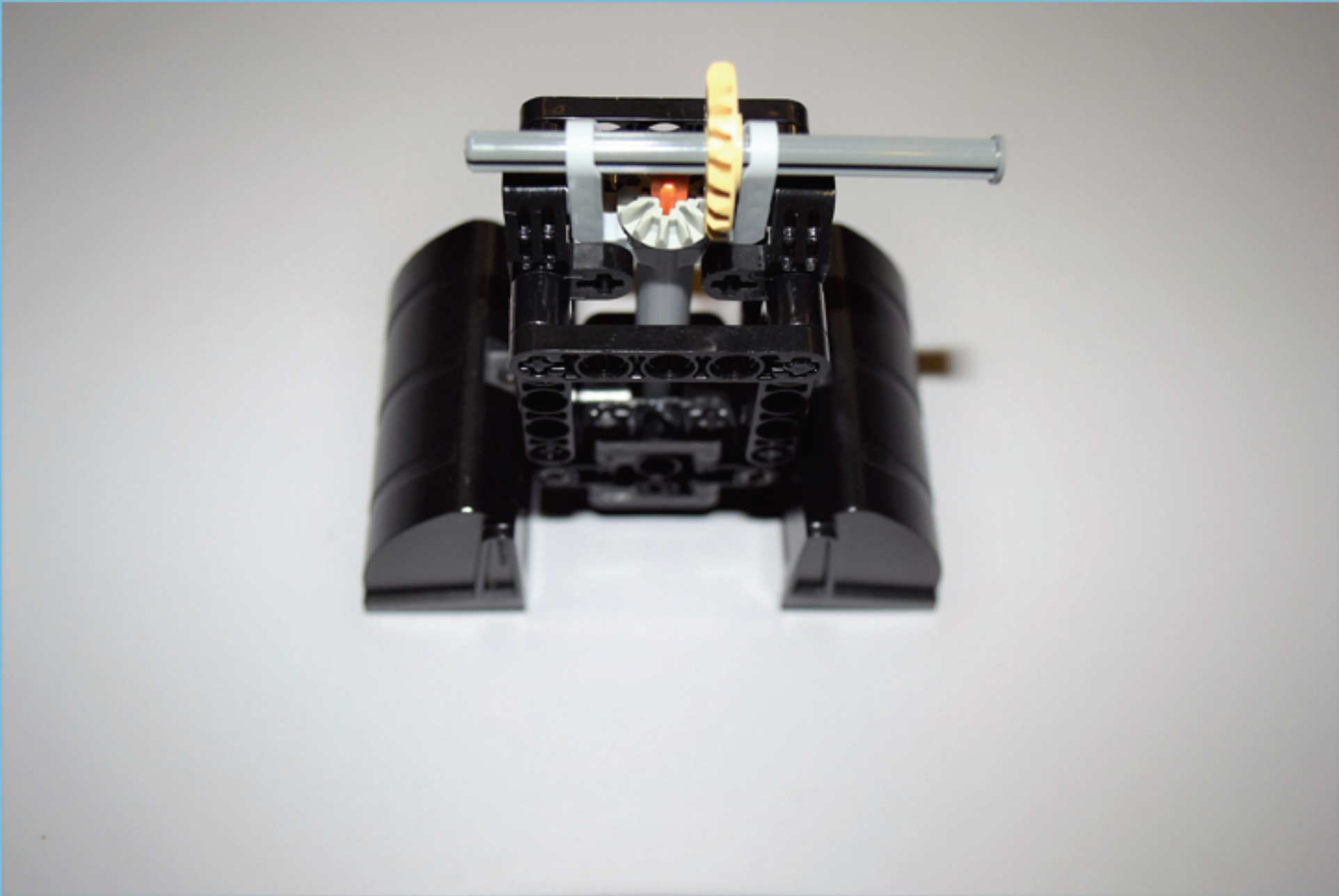

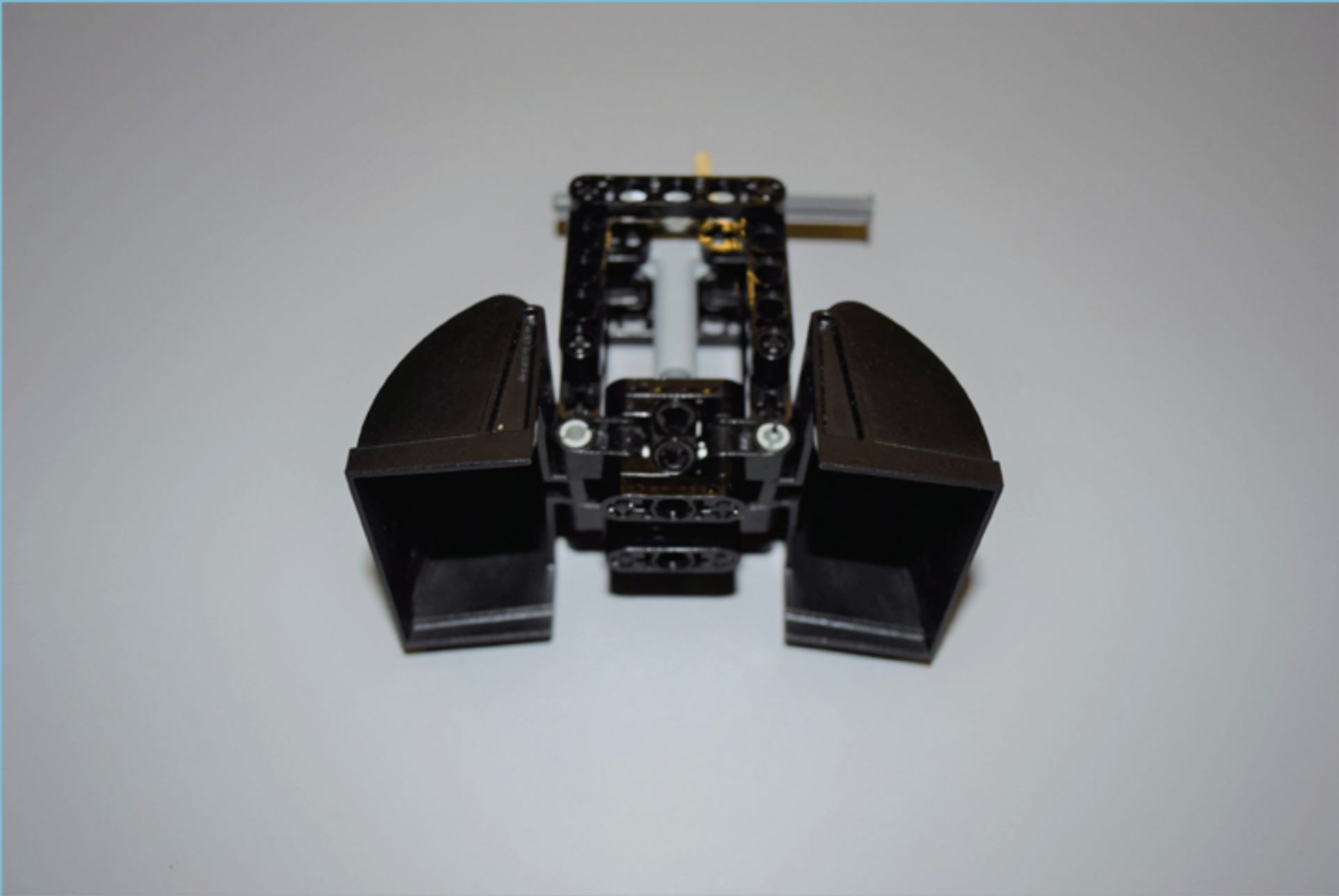

Parts for the Claw

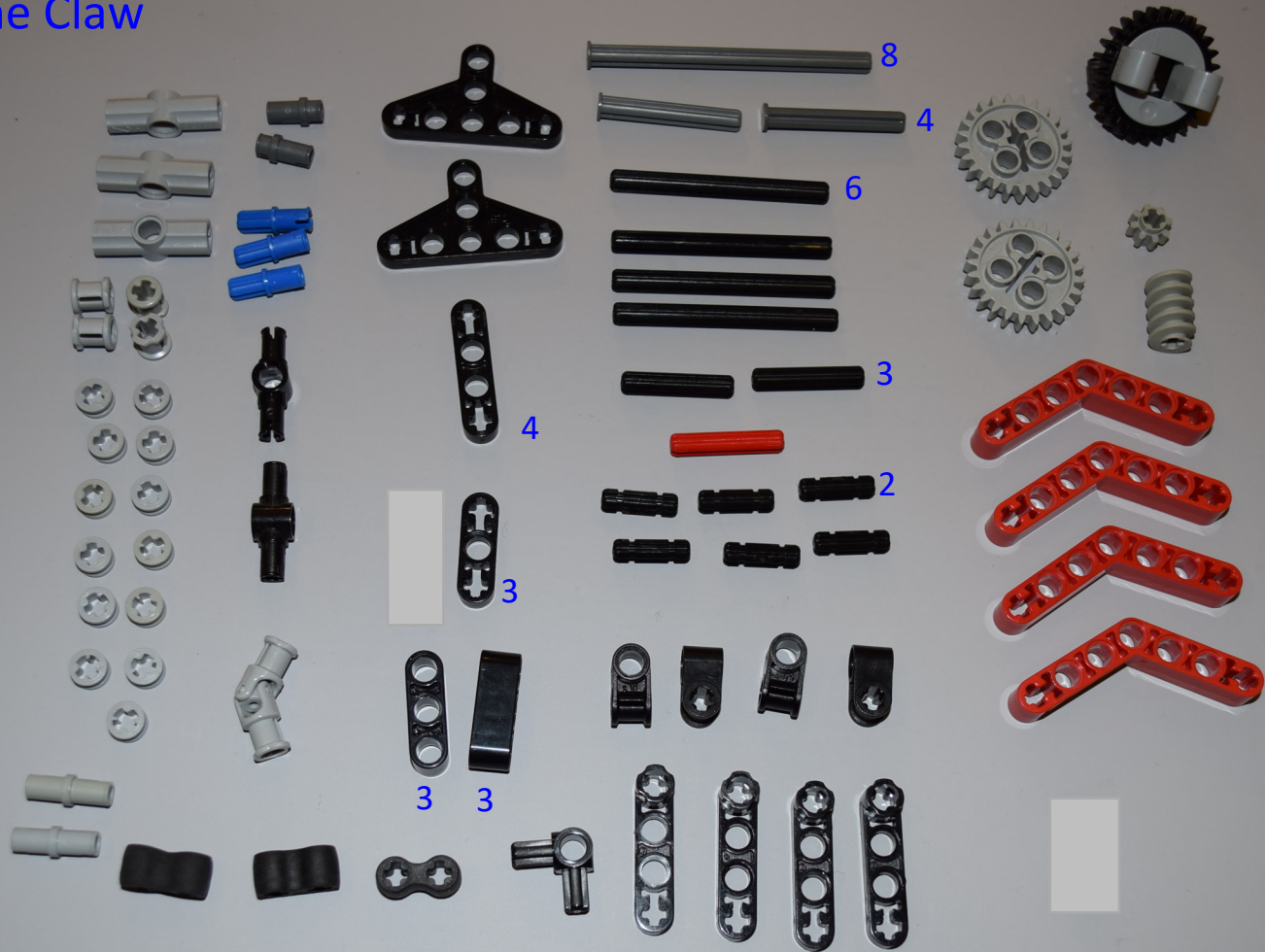

add 2x 1x5 1/2 left arm with axle holes





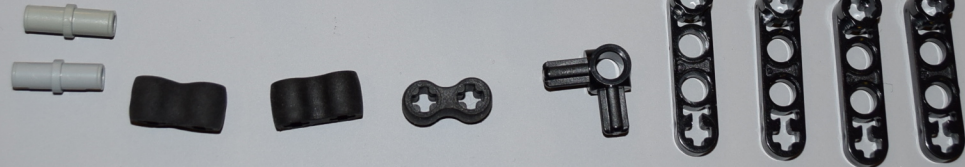
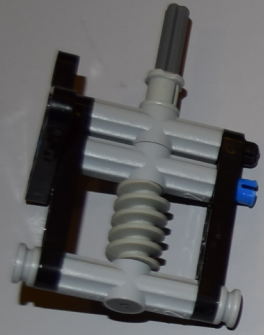



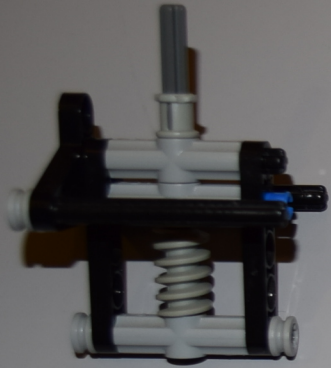

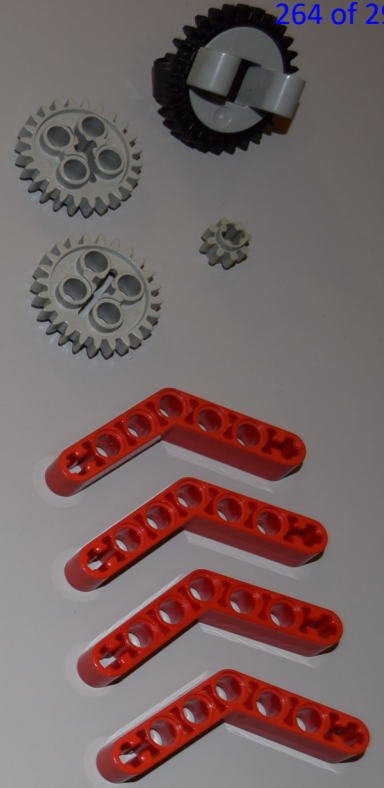
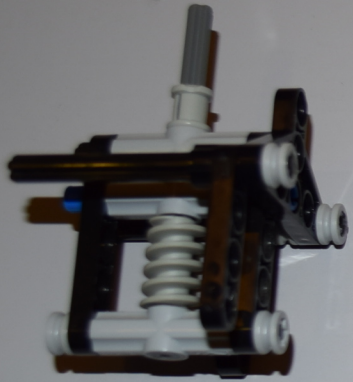

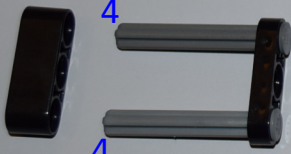
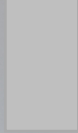
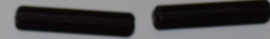
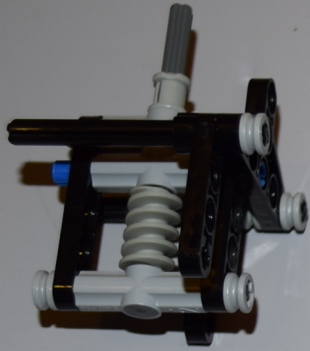







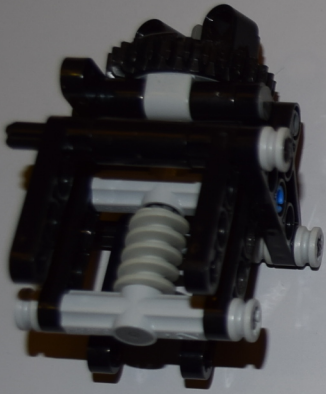



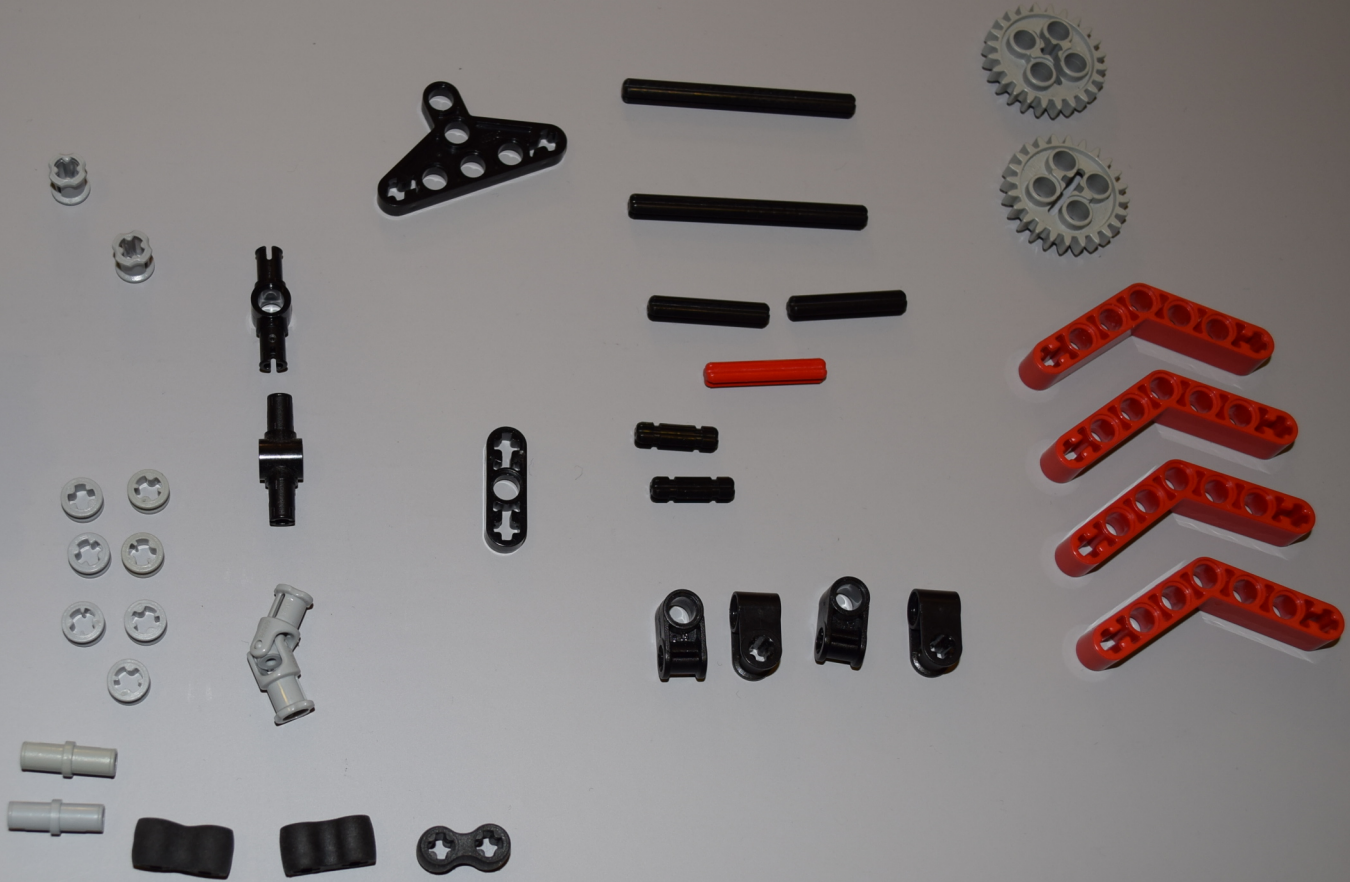
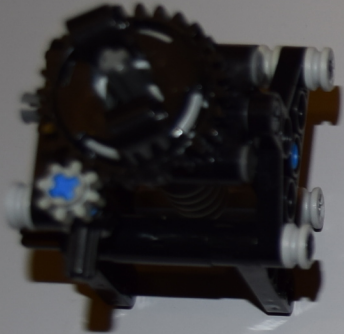

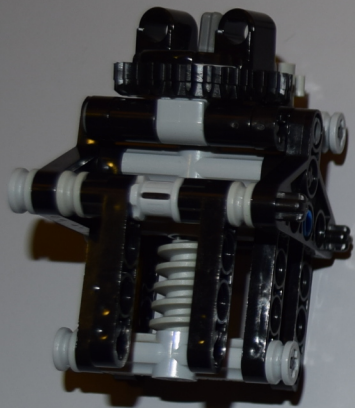



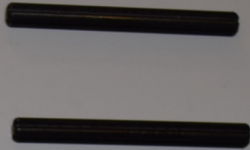

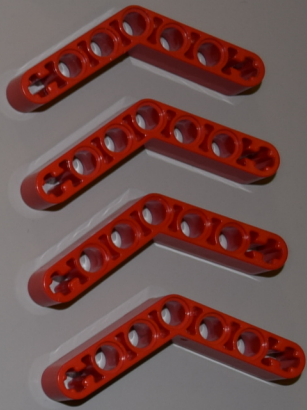
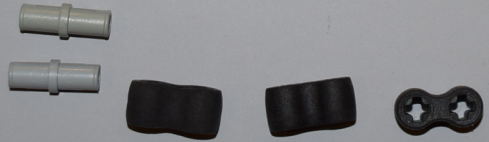
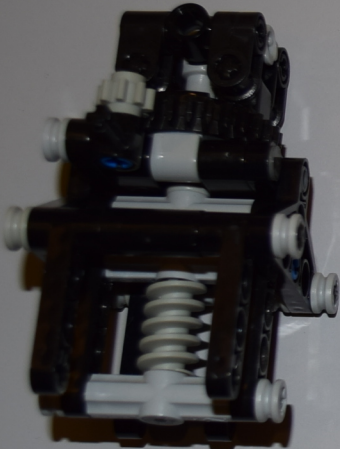

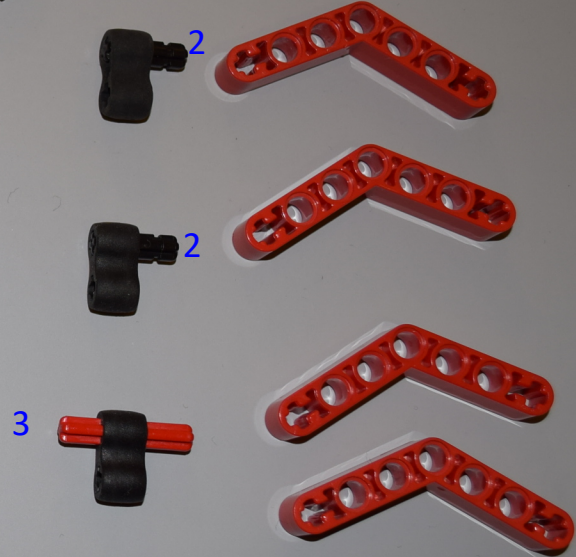
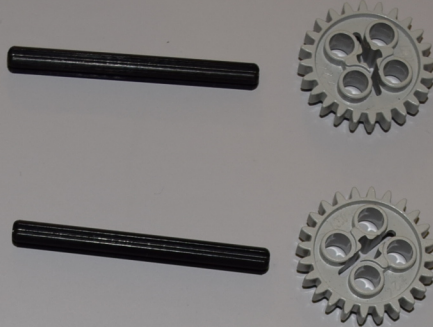
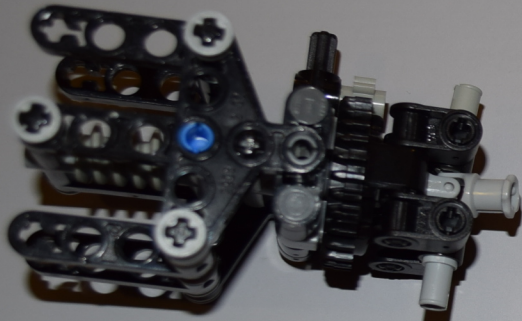

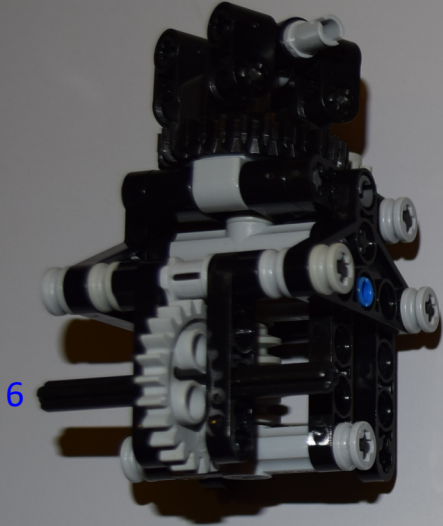

6



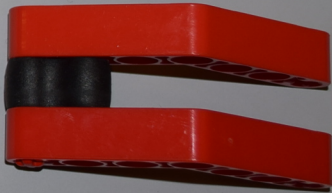
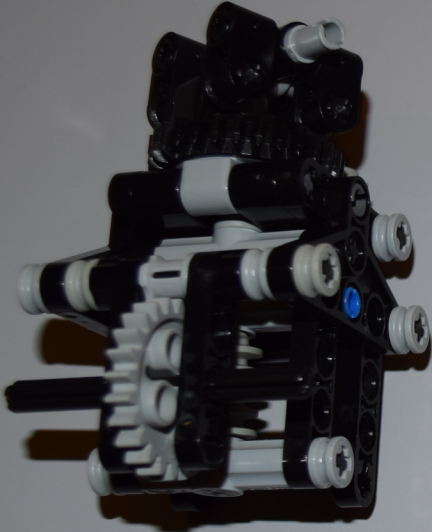

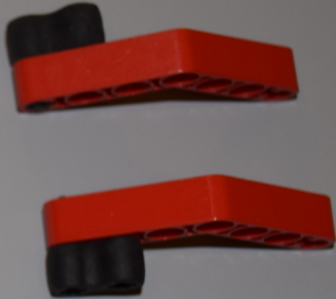
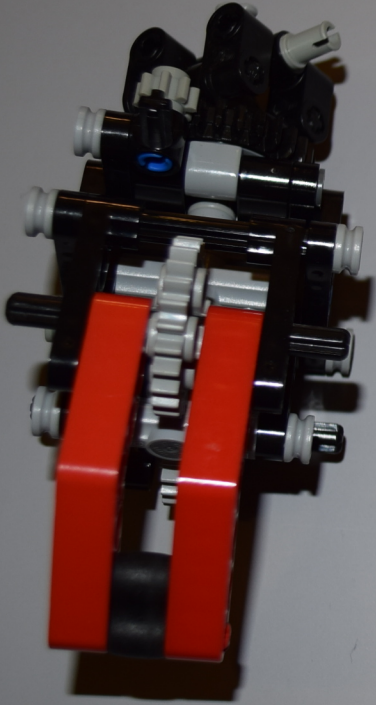

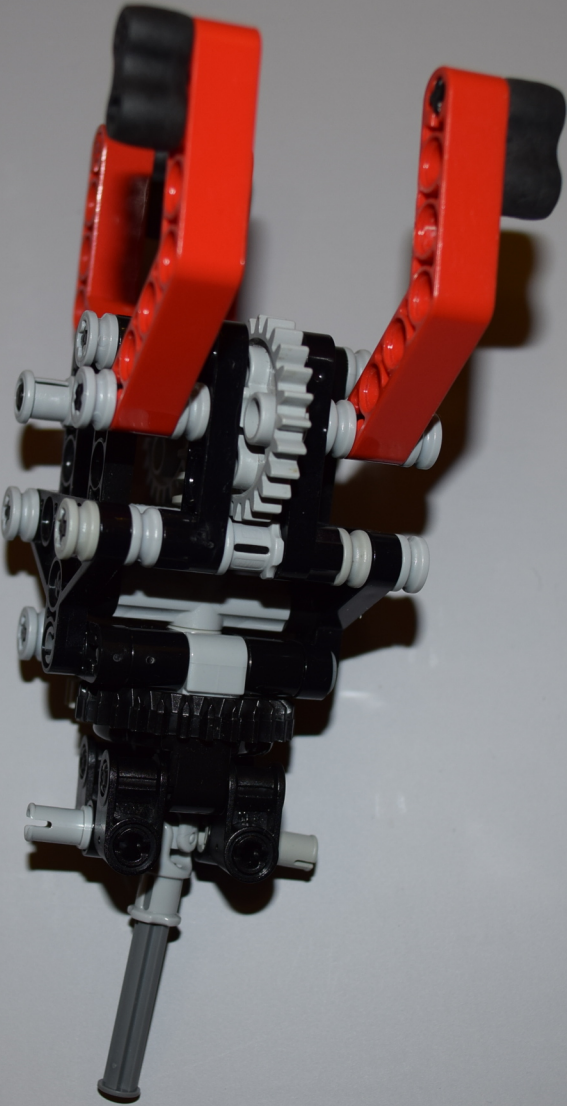

6 Bucket Options



Original, Medium Bucket, Small Bucket, Grapple, Clamshell, Claw

Original Bucket

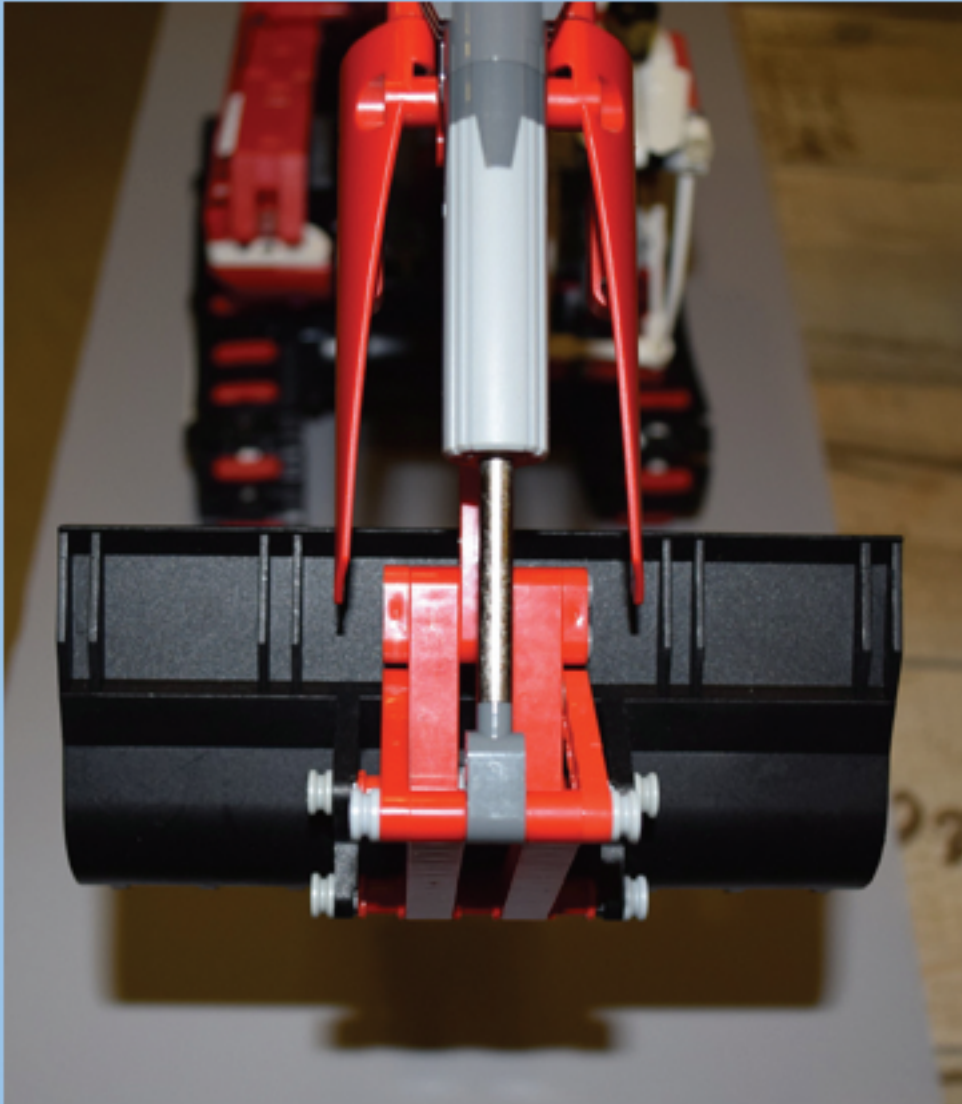

Medium Bucket with original lift arm

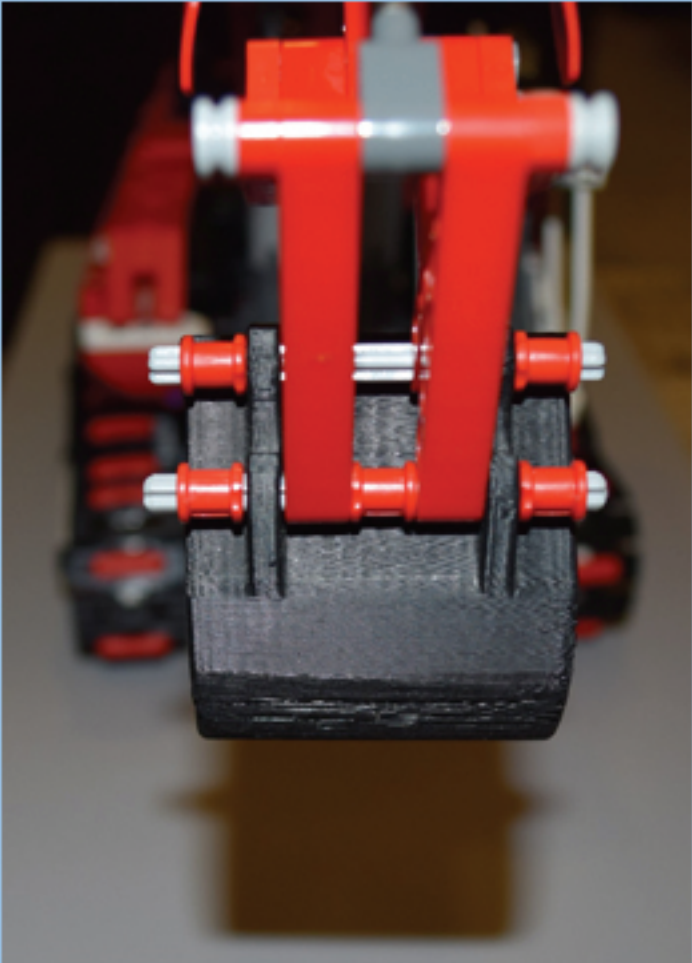
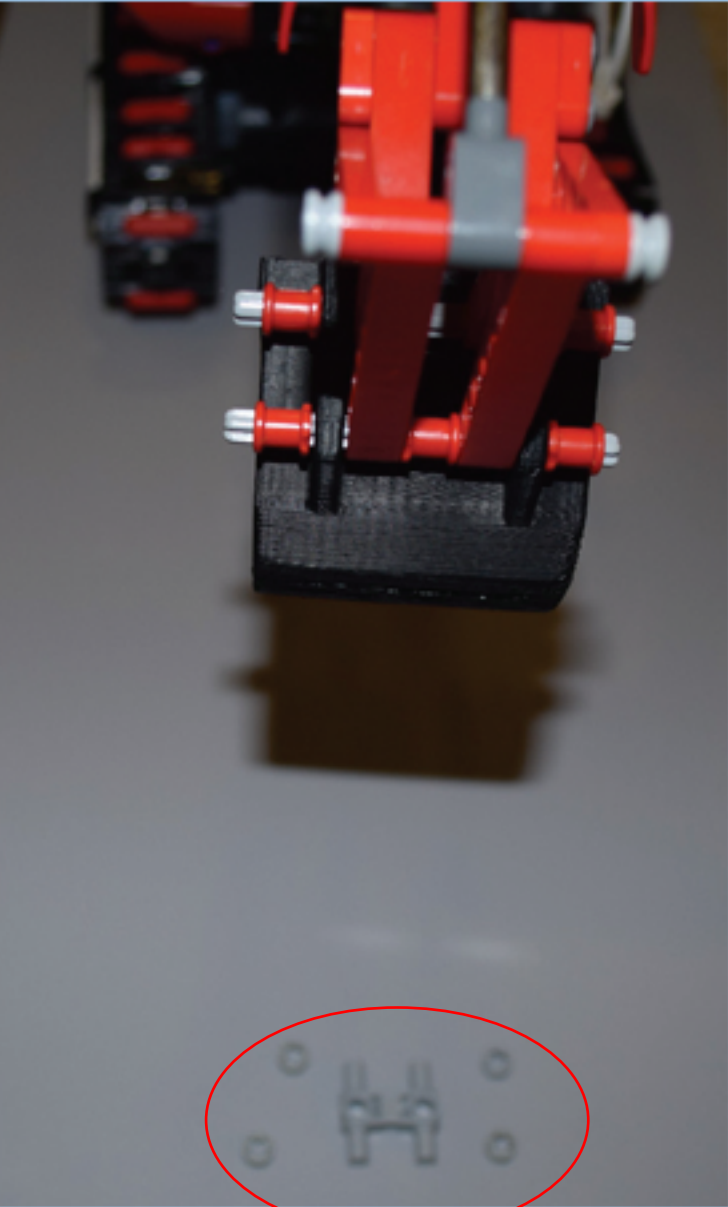

Parts to be removed

Medium Bucket with Krooshoop lift arm

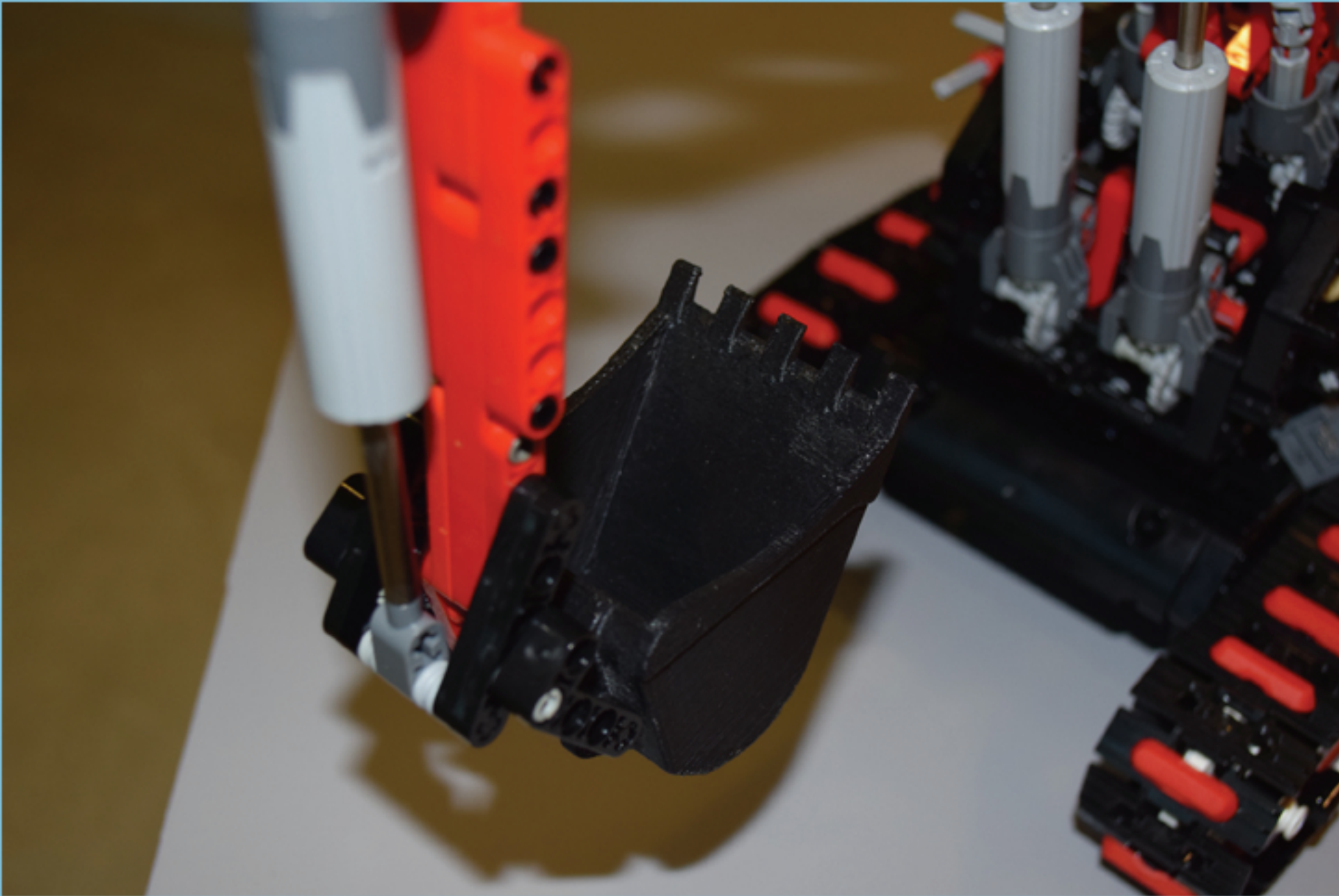

Medium Bucket with Krooshoop lift arm

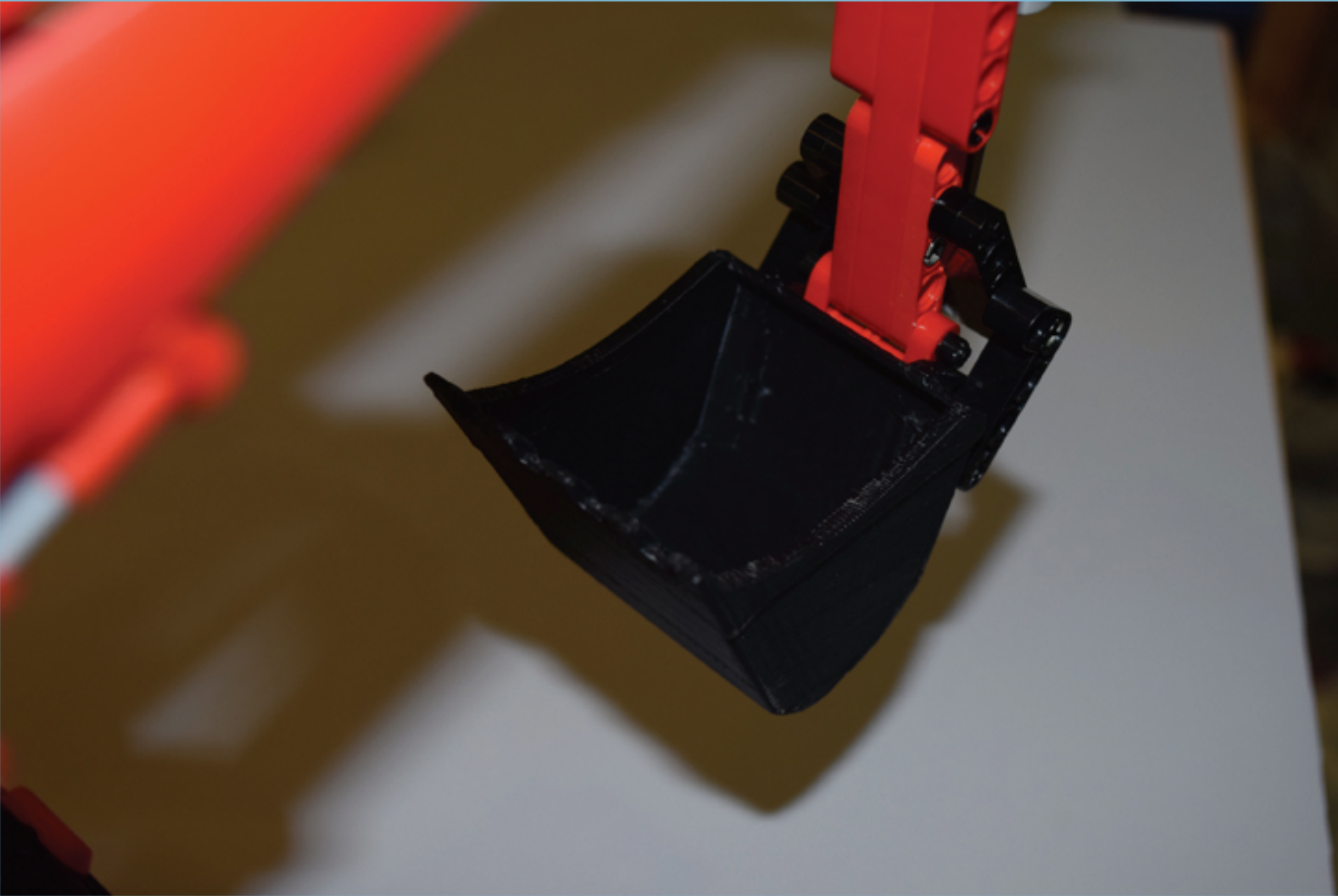

Small Bucket

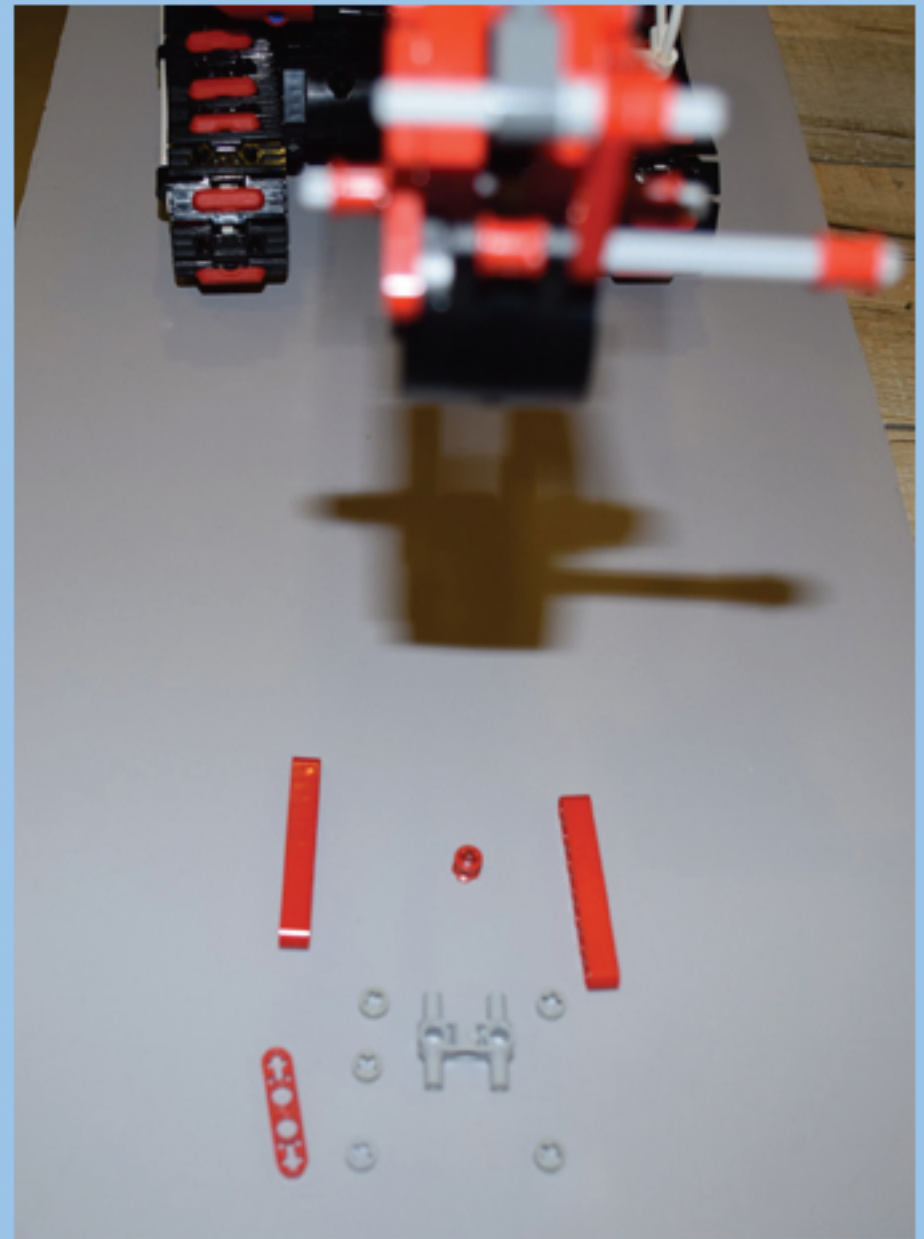
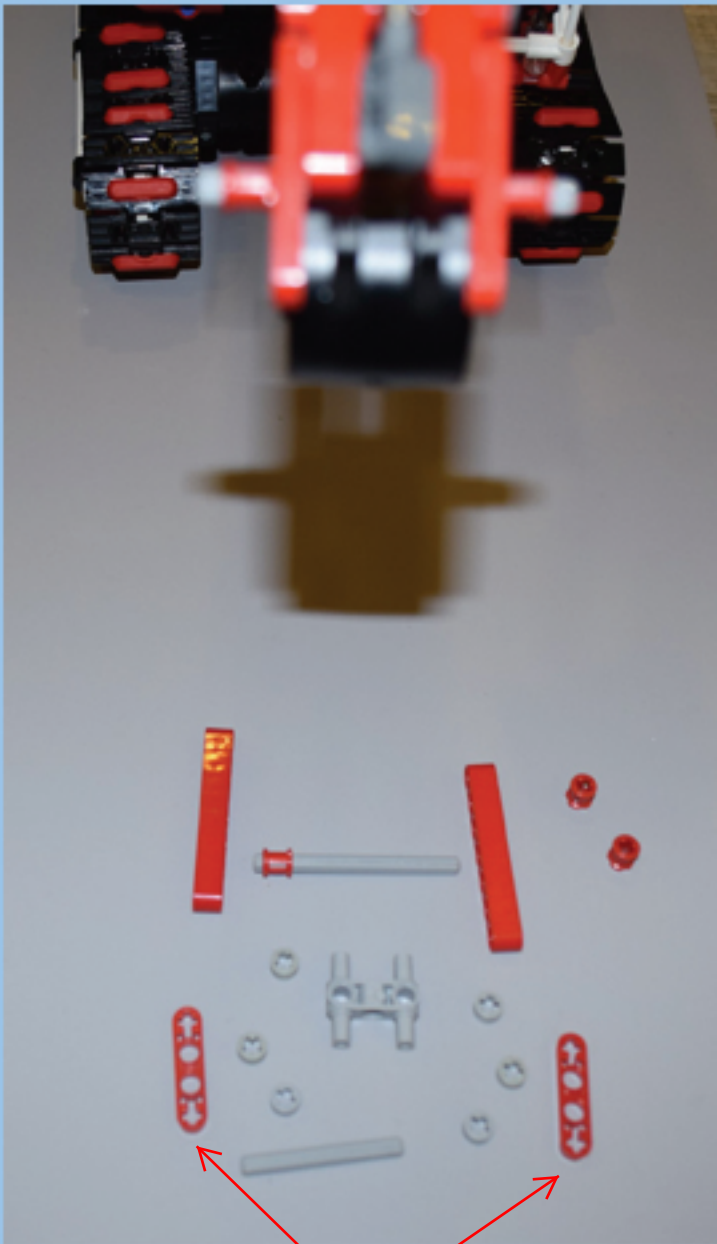

replacing the 7 length lift arms

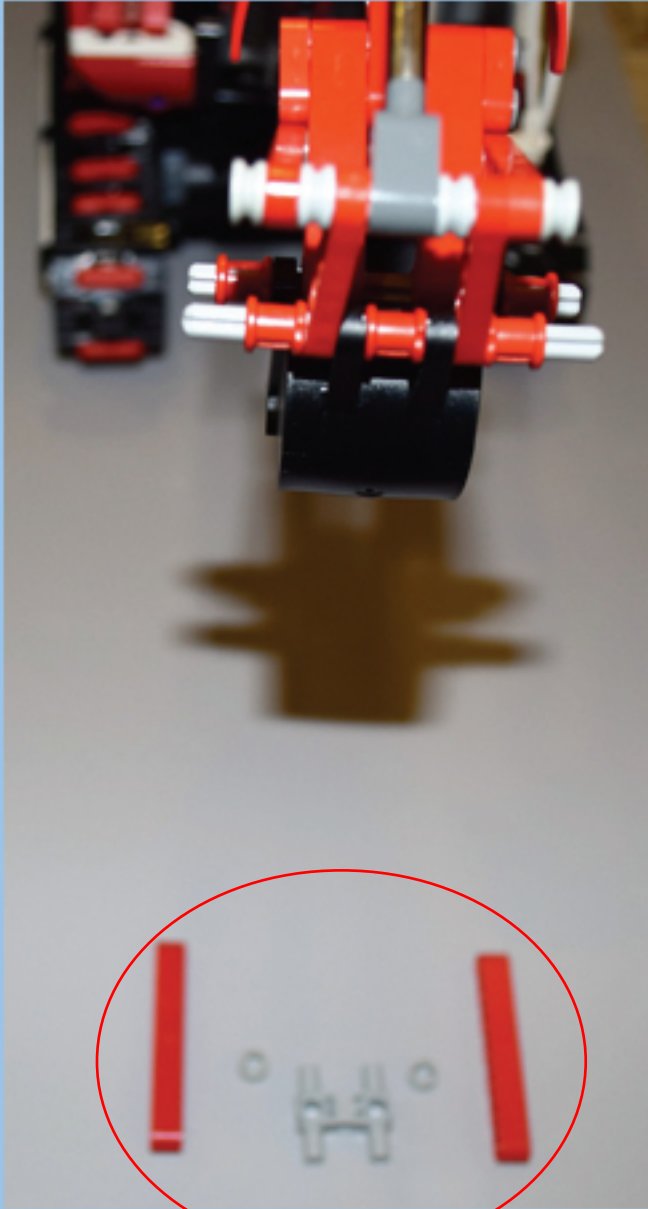

parts to be removed

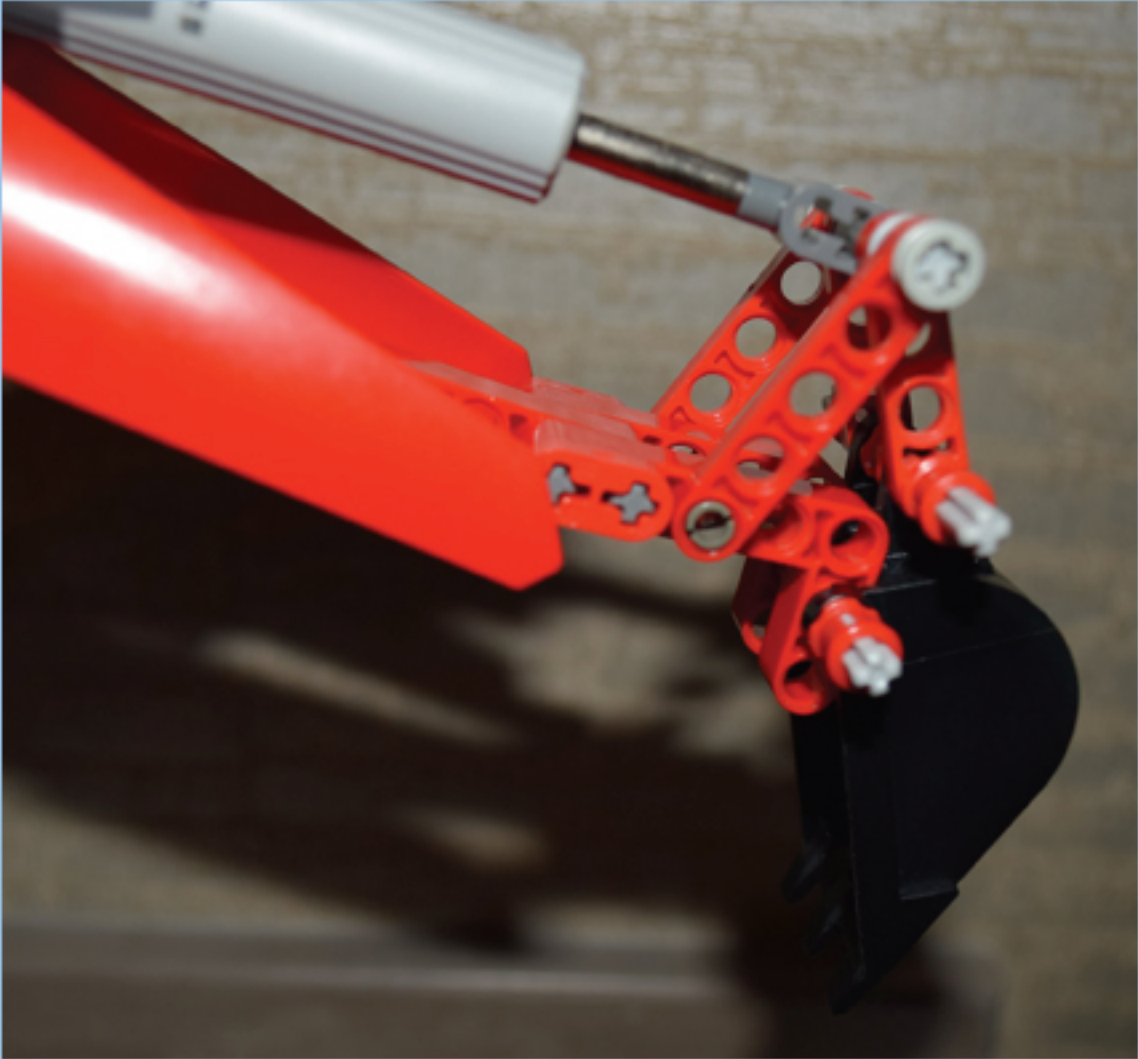

remove this parts in order to install the Clamshell, Grapple or Claw

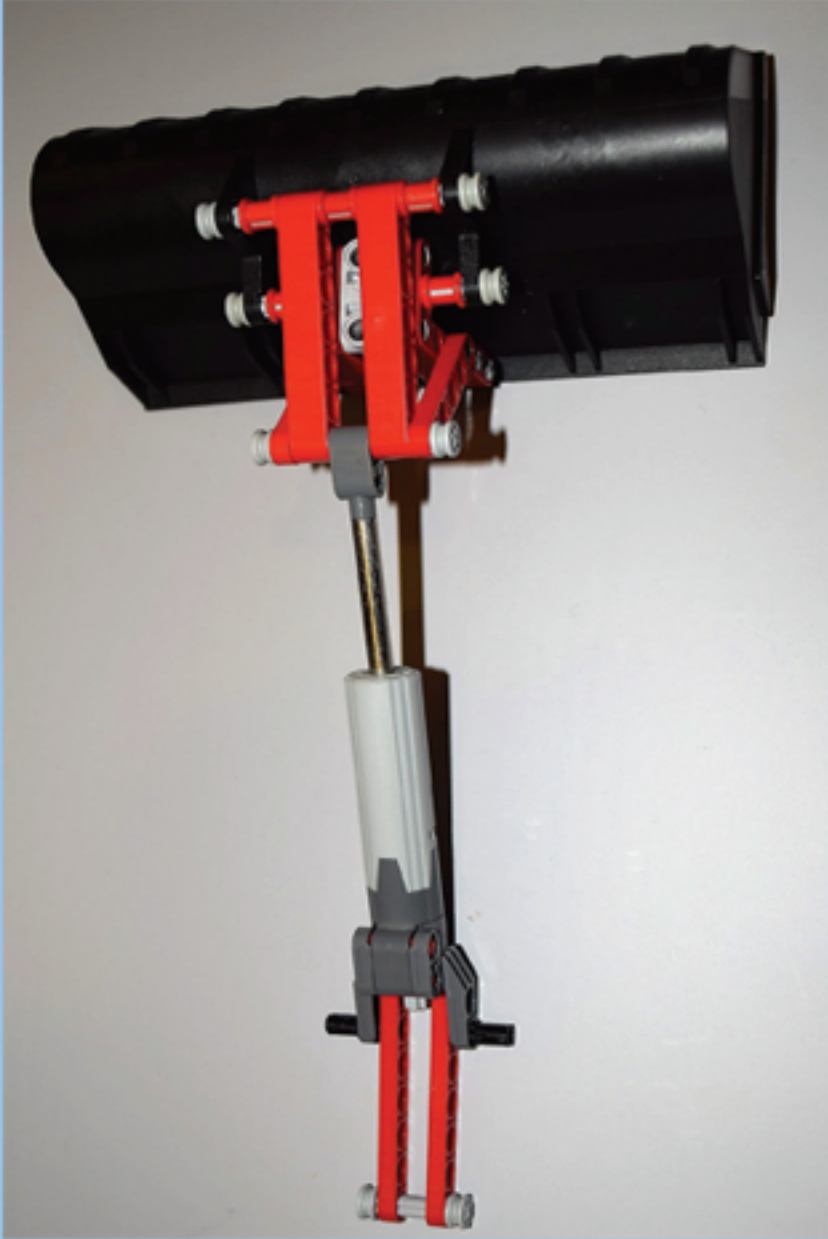

Setup for the grapple, Clamshell and Claw

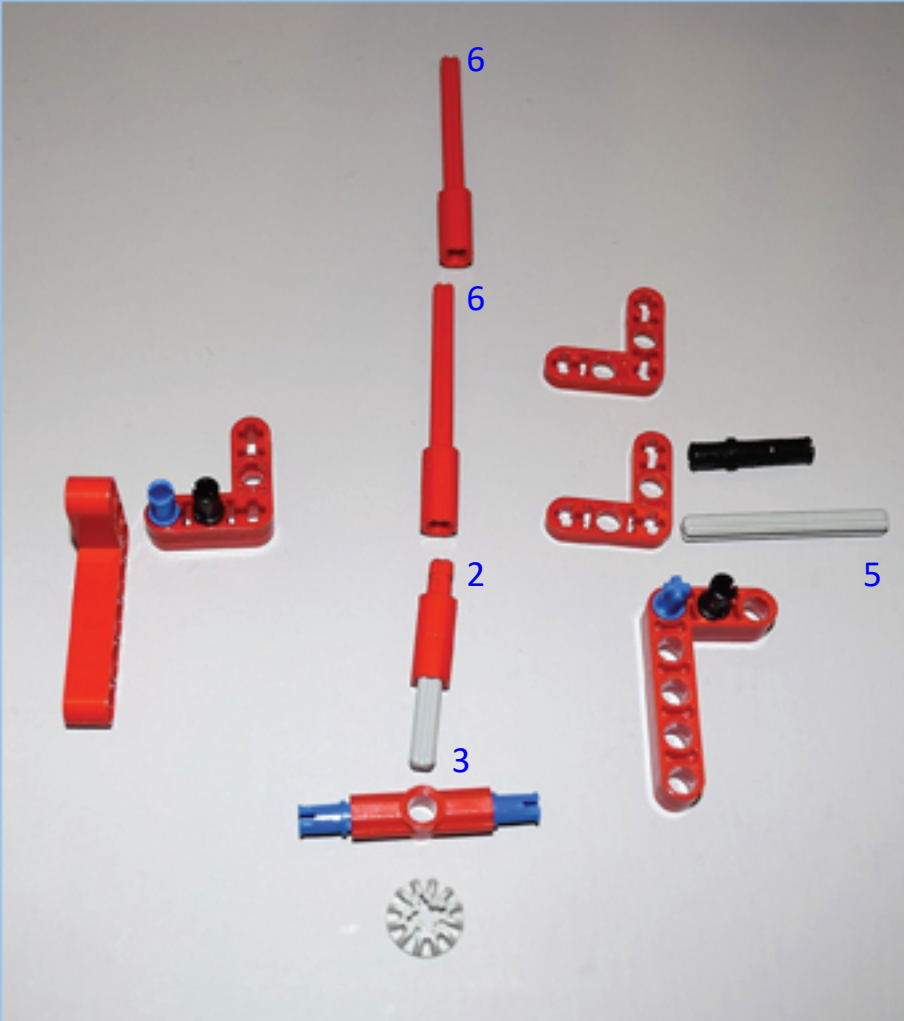

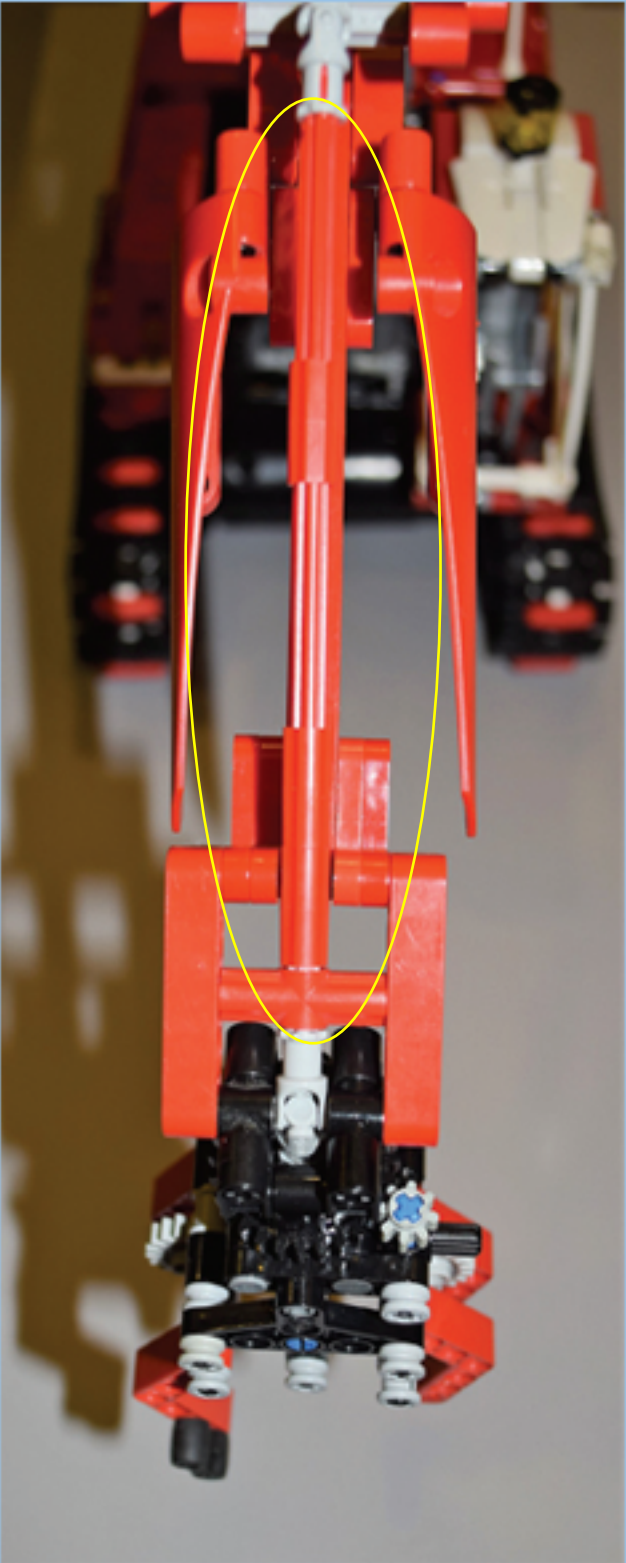
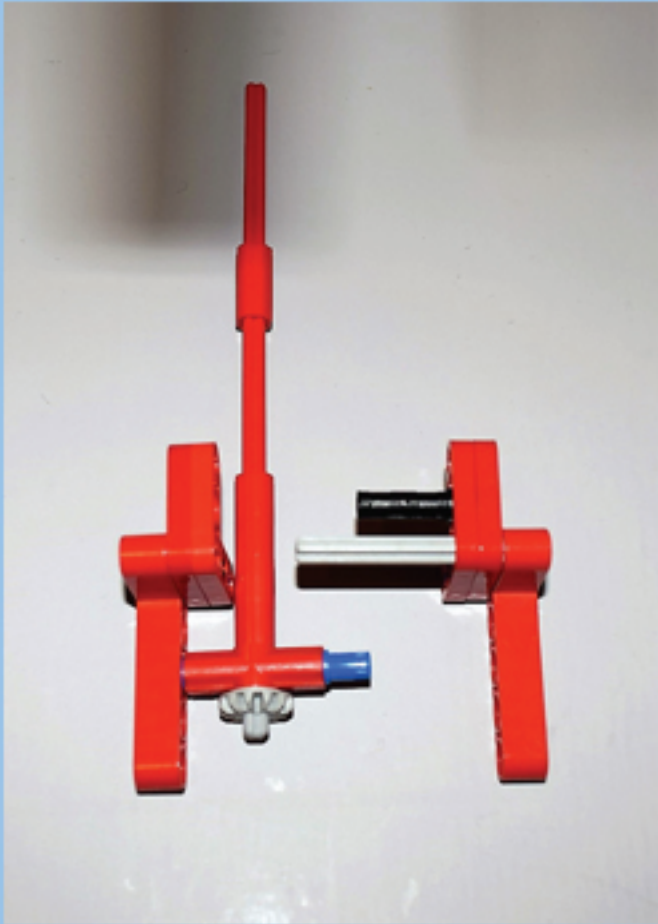

Grapple

