

Instructions for modifying of the
Lego® Technic 8043 Motorized Excavator
into the

ULTIMATE 8043



This mod will give the 8043:

- * 8878 Rechargeable battery
- * Complete simultaneous control of all the motorized functions
- * Joystick-controller that works just like a real excavator
- * XL-motor for more considerable boom-lifting power
- * PF-lights
- * More realistic bucket looks & larger operating range
- * Larger operating range for the dipper
- * Roof for the cabin
- * All gear-reduction has been moved to the undercarriage to reduce the side-effects of transferring the drivetrain through the turntable

These modifications and instructions were made by Jurgen Krooshoop (Jurgens Technic Corner)

See my models in action:

<http://www.youtube.com/user/Rhodeslover1>

More info & models can be found at my MOC-page:

<http://www.mocpages.com/home.php/21811>

and my brickshelf-folder:

<http://www.brickshelf.com/cgi-bin/gallery.cgi?m=Jurgmeister>

The original instructions are available at

<http://www.brickset.com/detail/?Set=8043-1>

LEGO® is a trademark of The LEGO Group, which does not sponsor, authorize or endorse these instructions & modifications. You can find the official Lego® site at <http://www.lego.com>

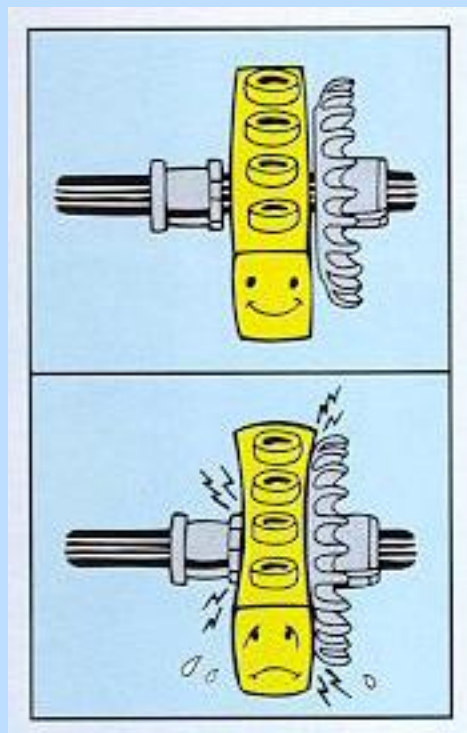

1

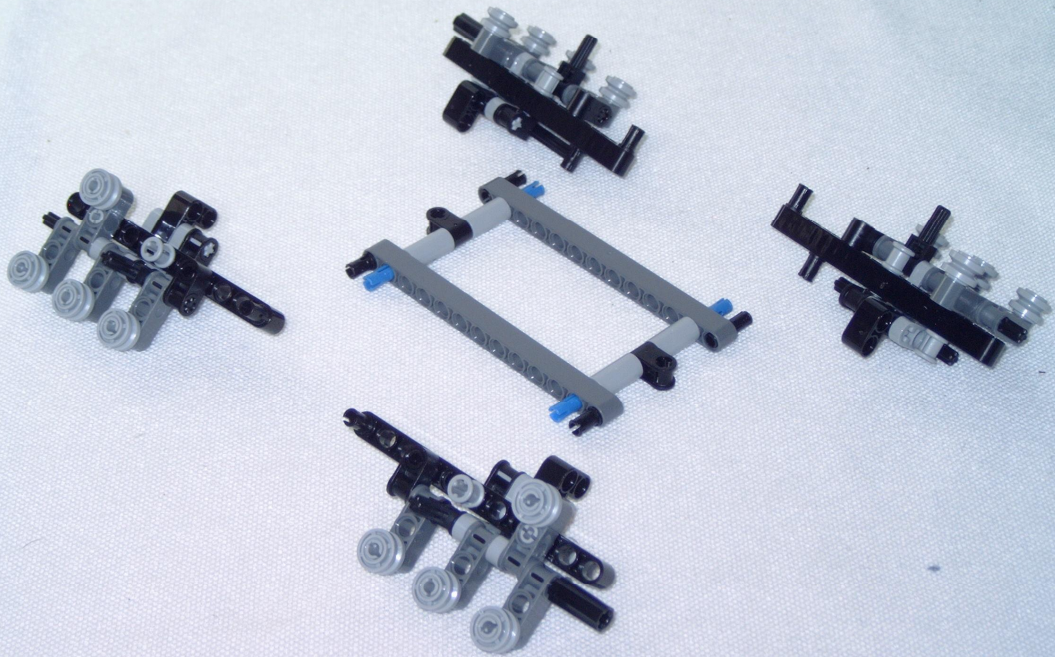

See step 1 - 11
(Book 1, page 10 - 18)

2

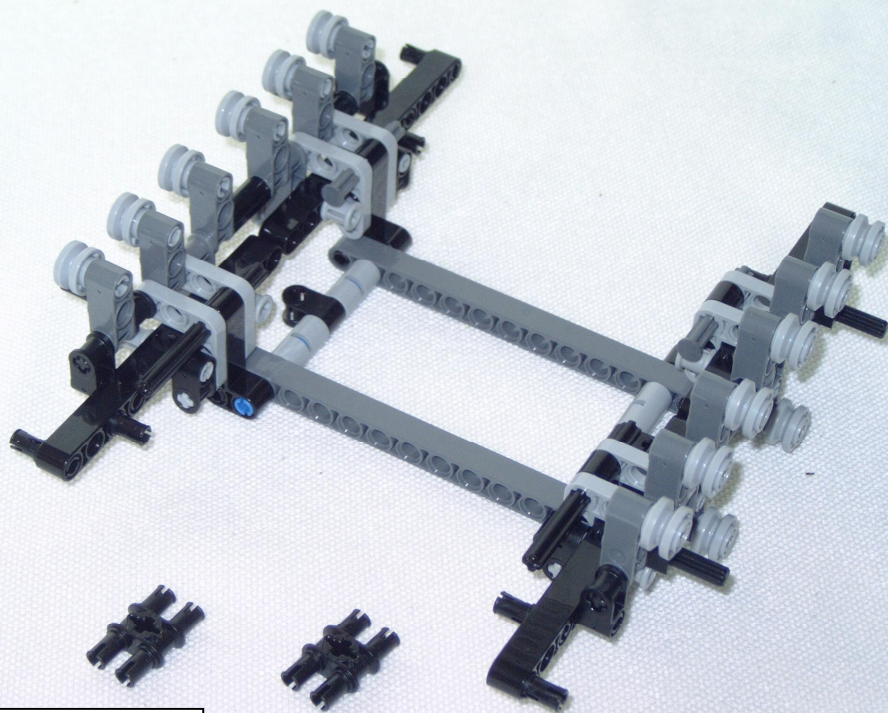

See step 12
(Book 1, page 18)

3

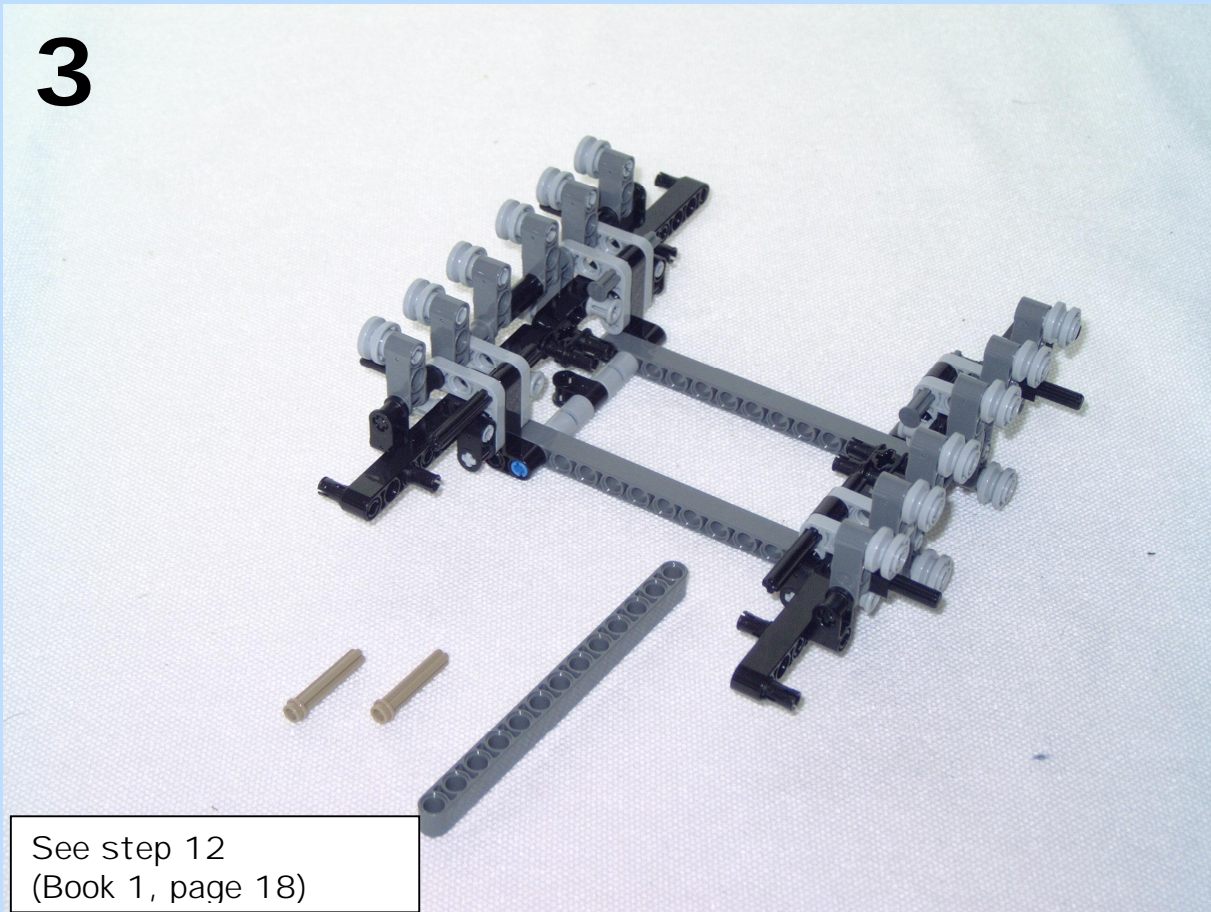

See step 12
(Book 1, page 18)

4

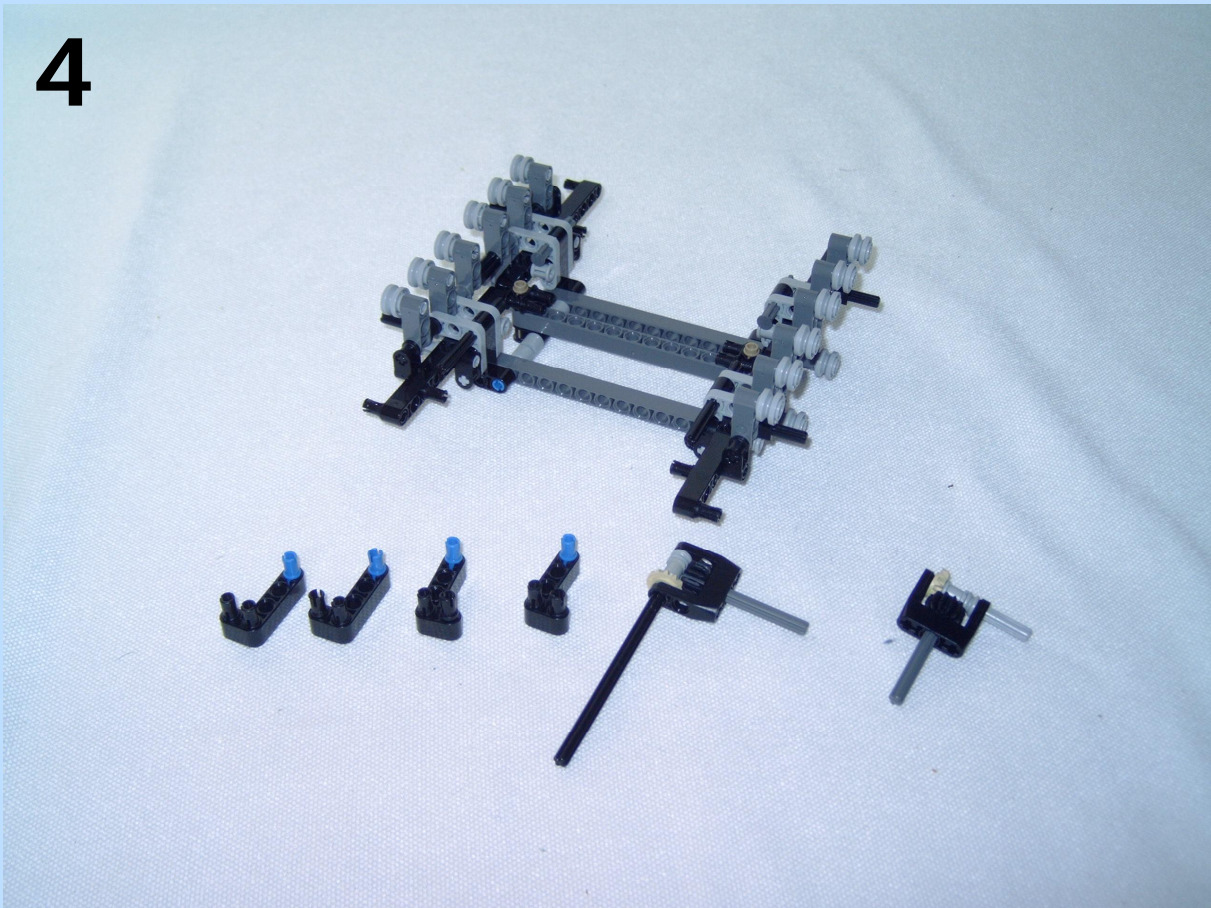

5

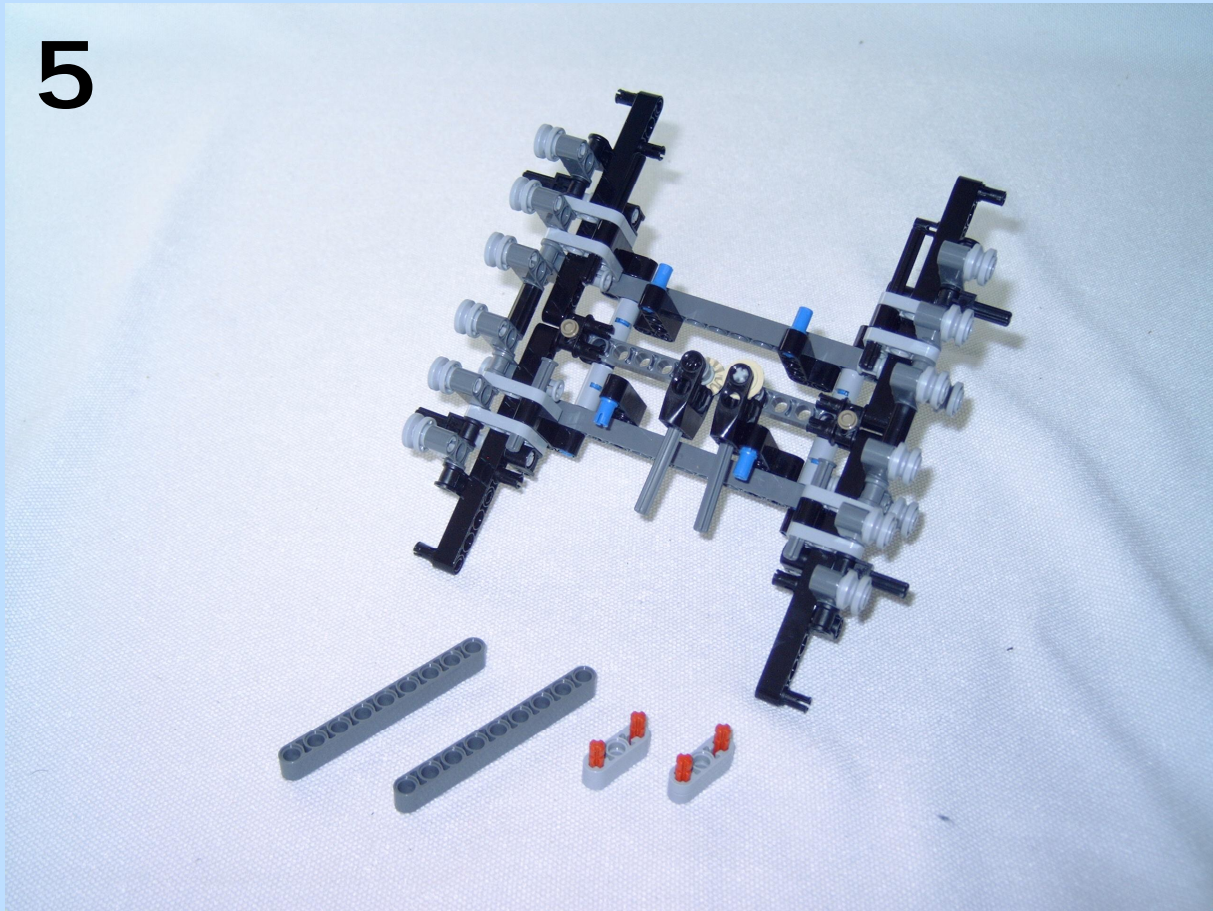

6

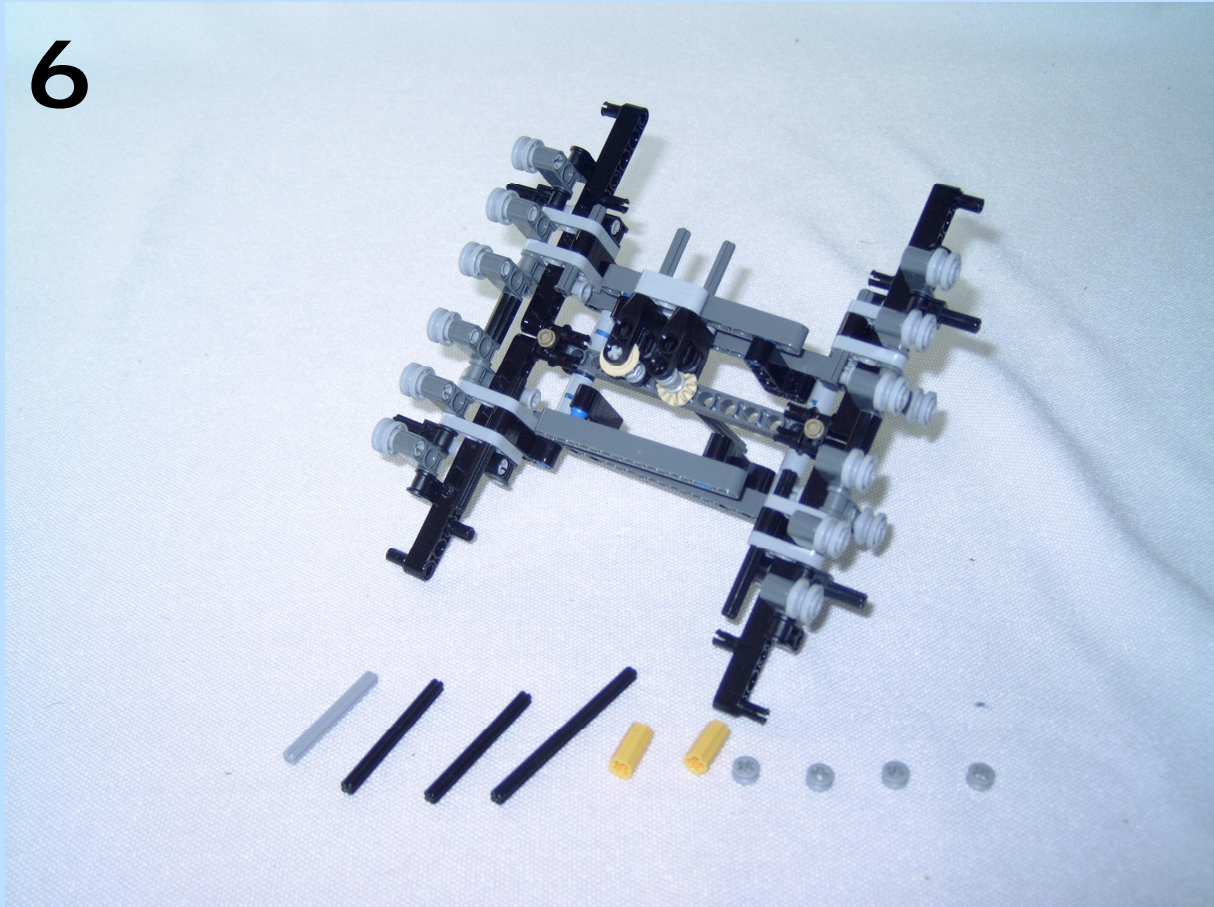

7

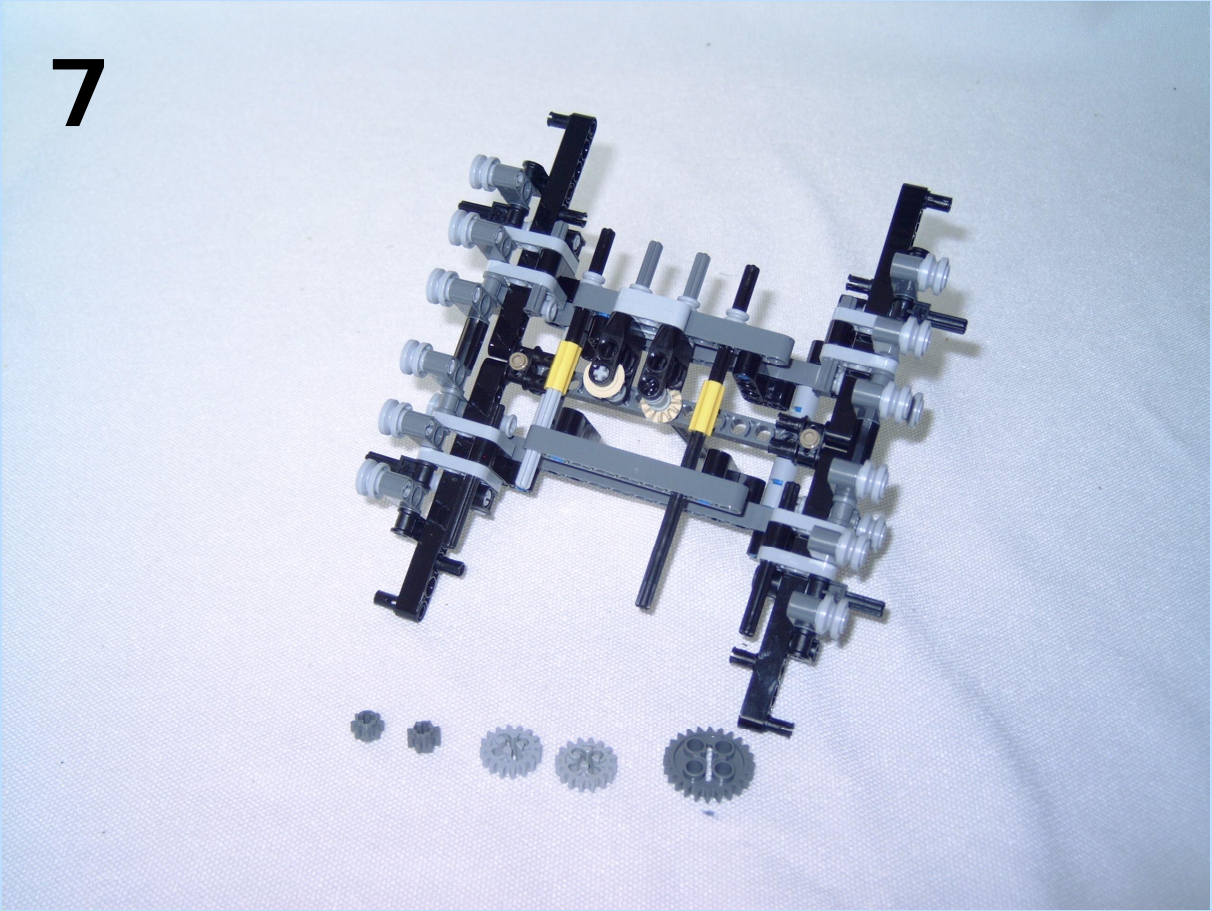

8

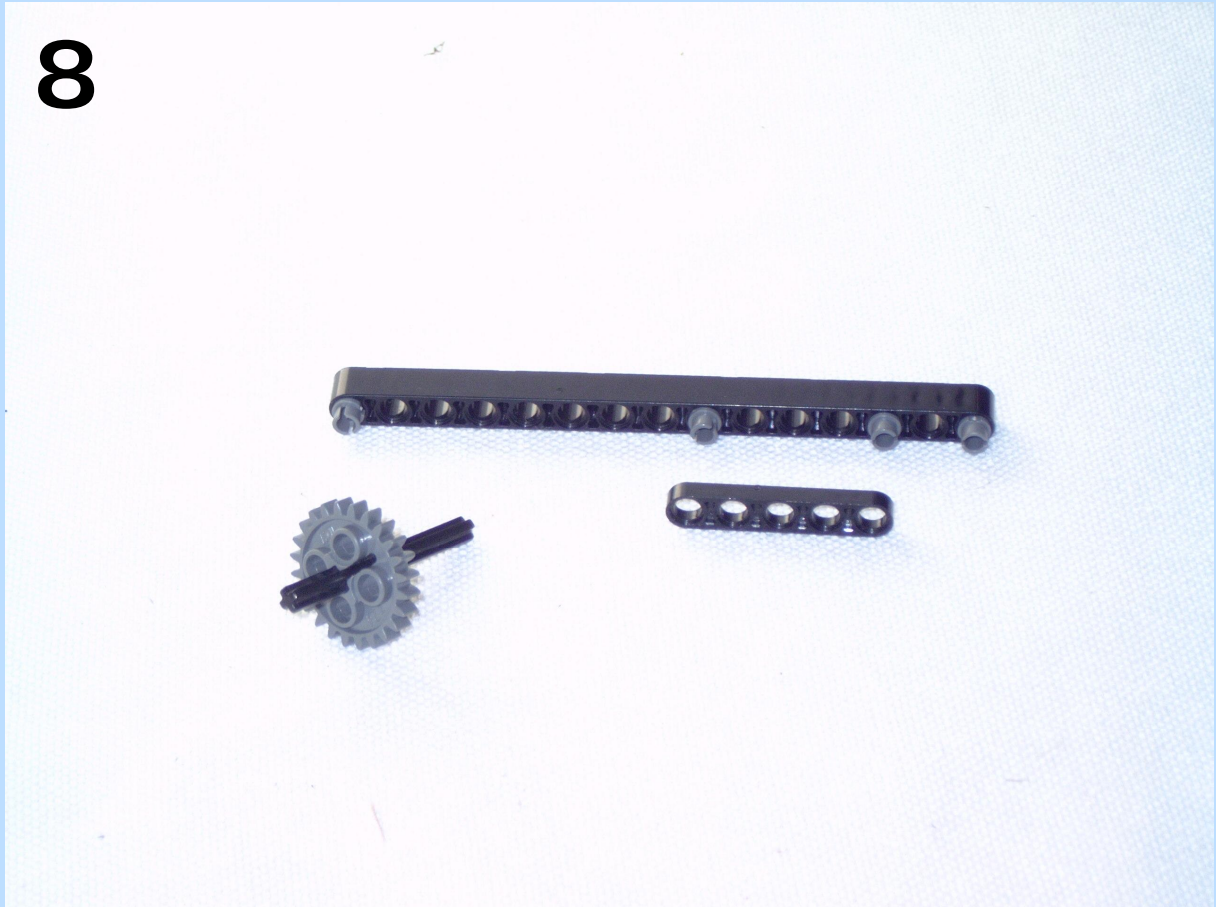

9

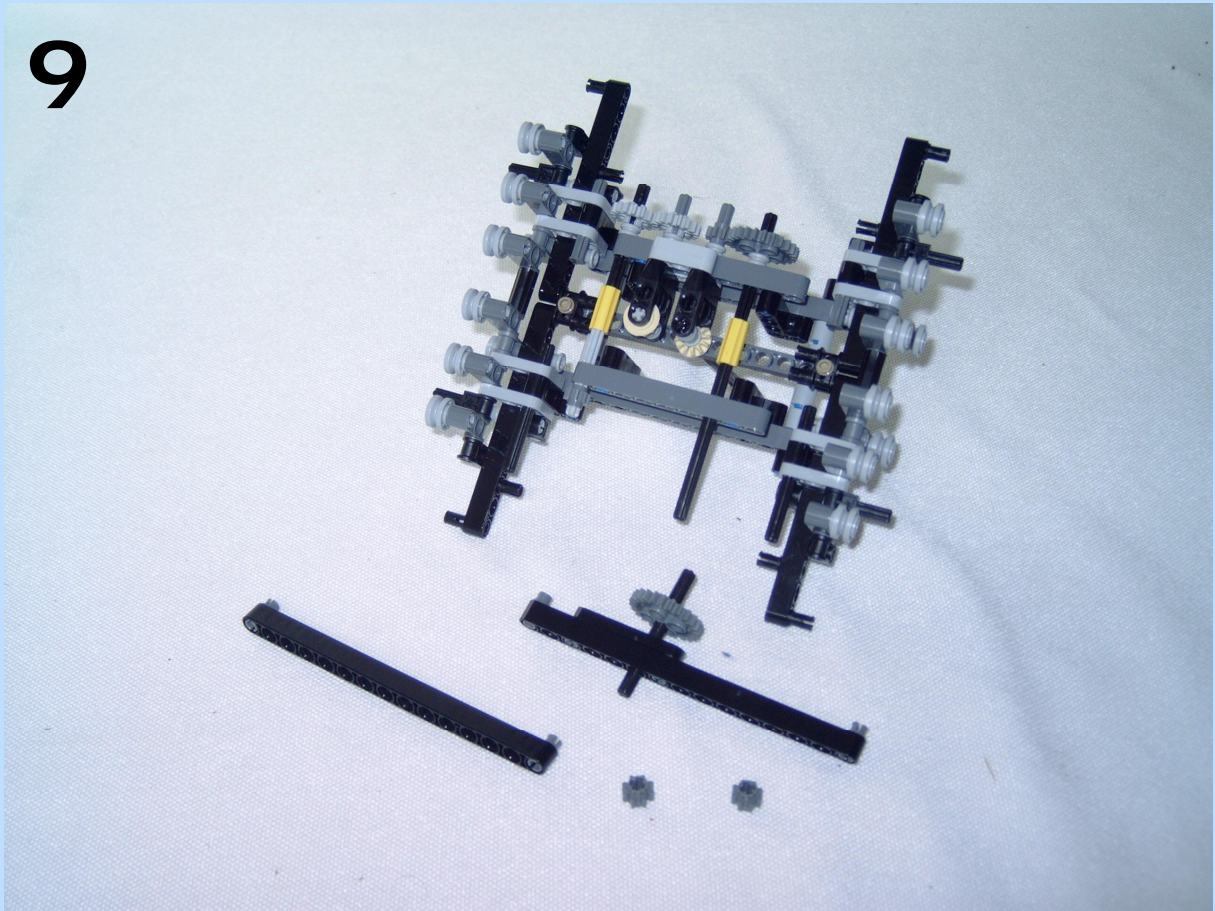

10

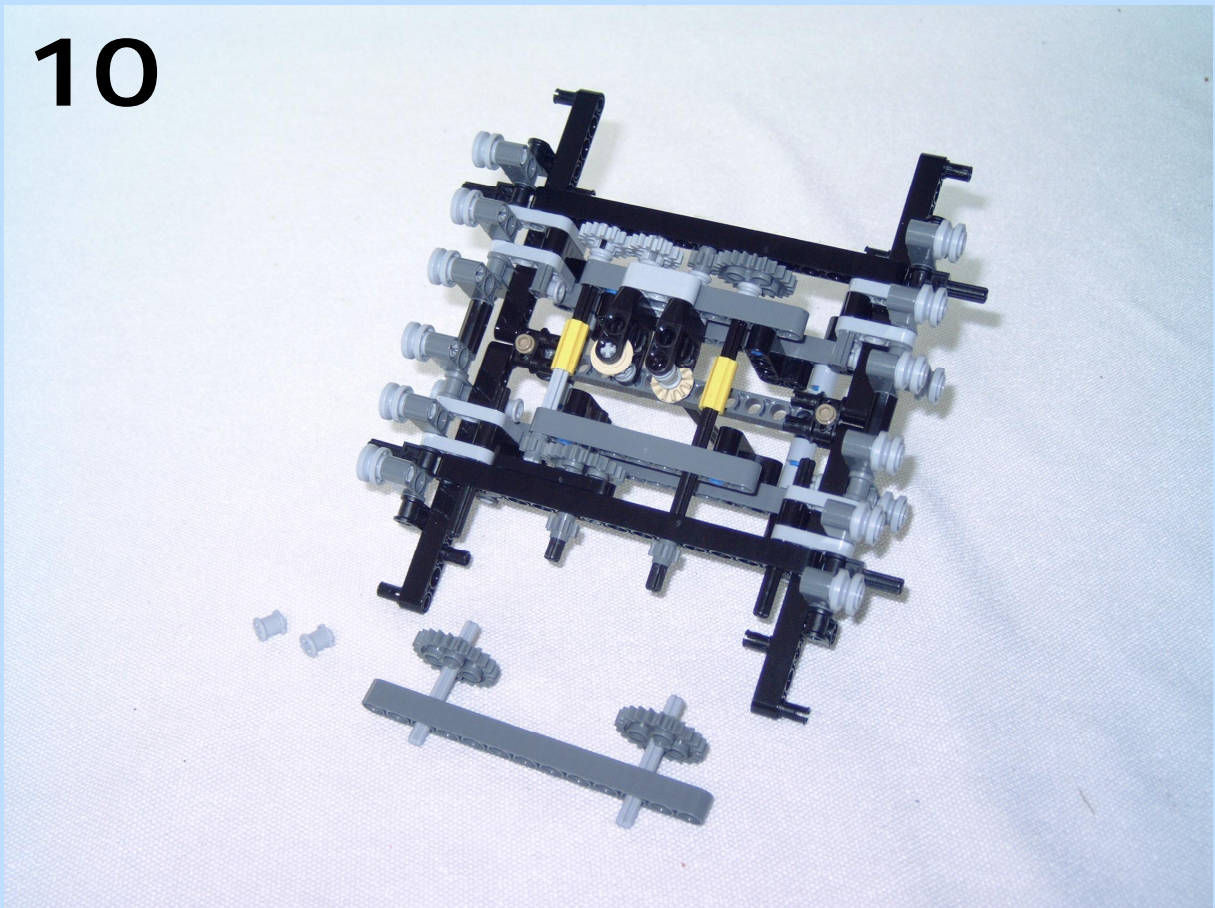

11

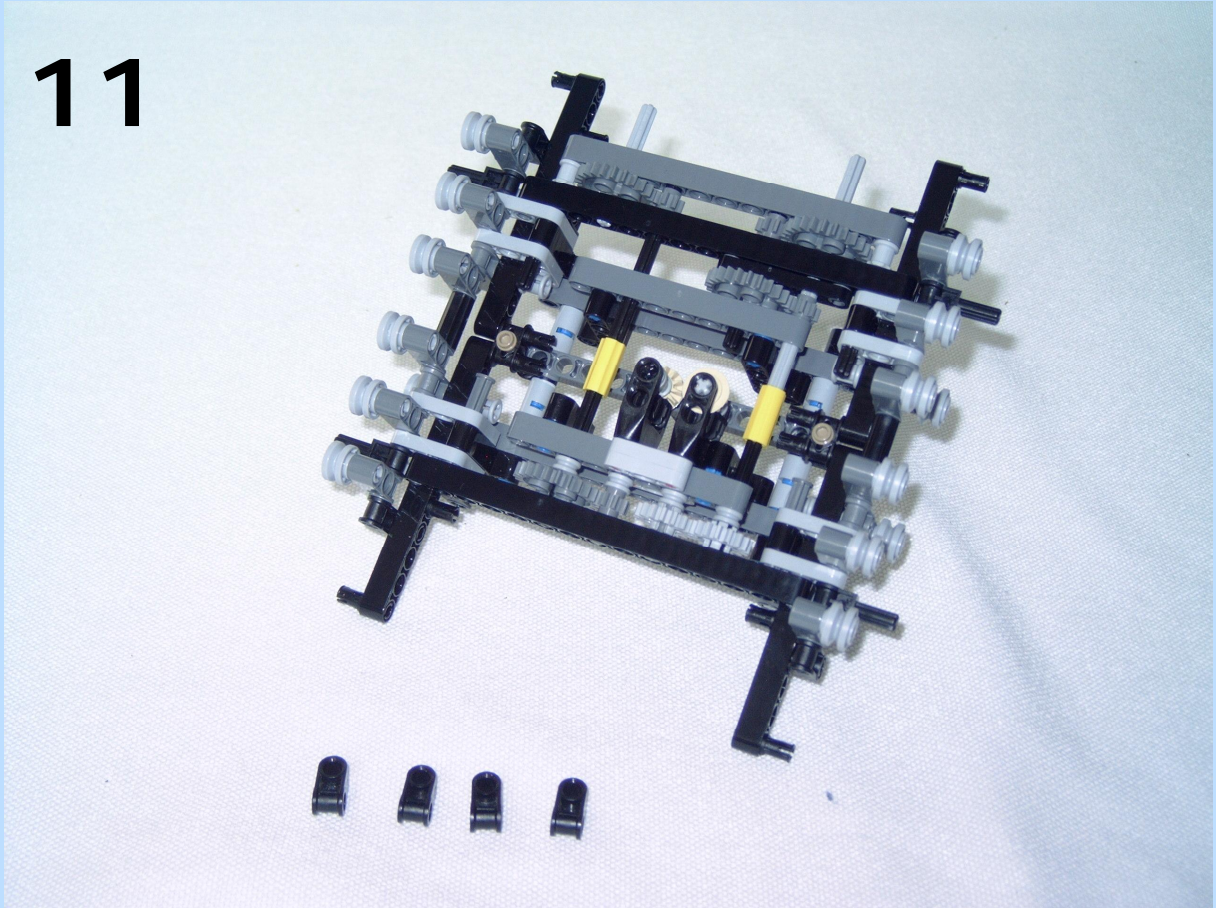

12

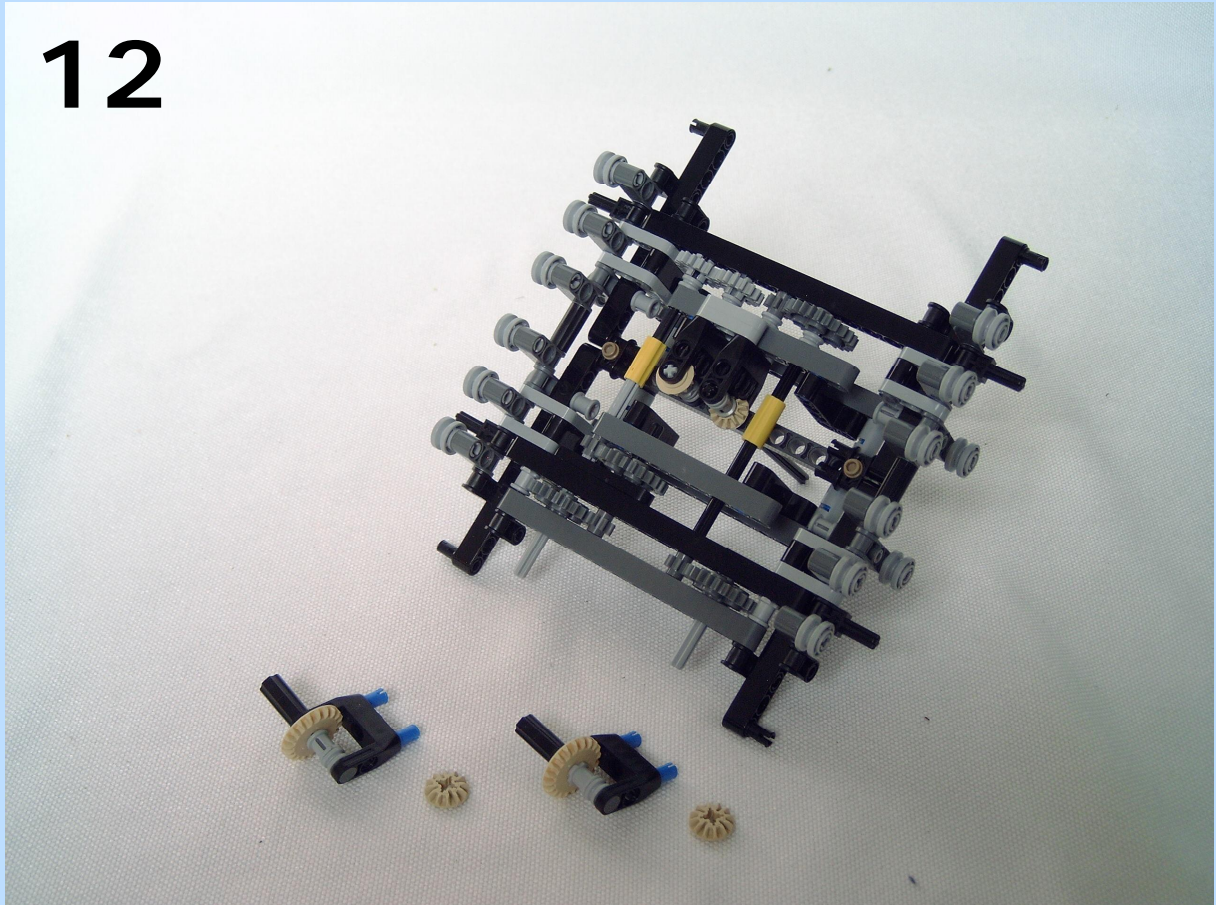

13

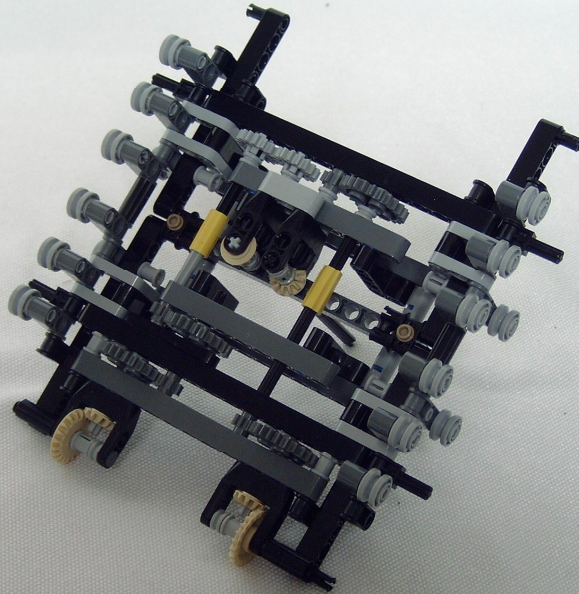

See step 18
(Book 1, page 27)

14

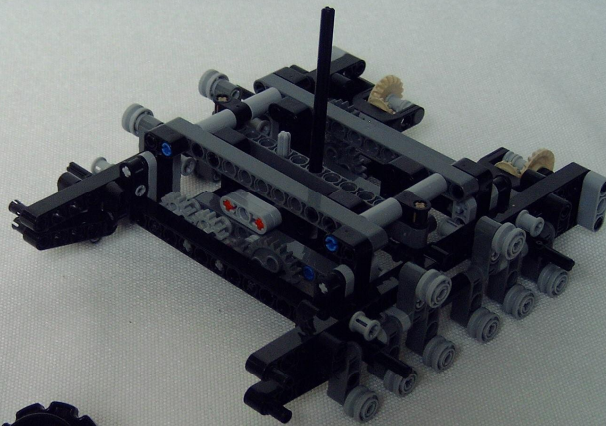

See step 21 - 22
(Book 1, page 28 - 29)

15

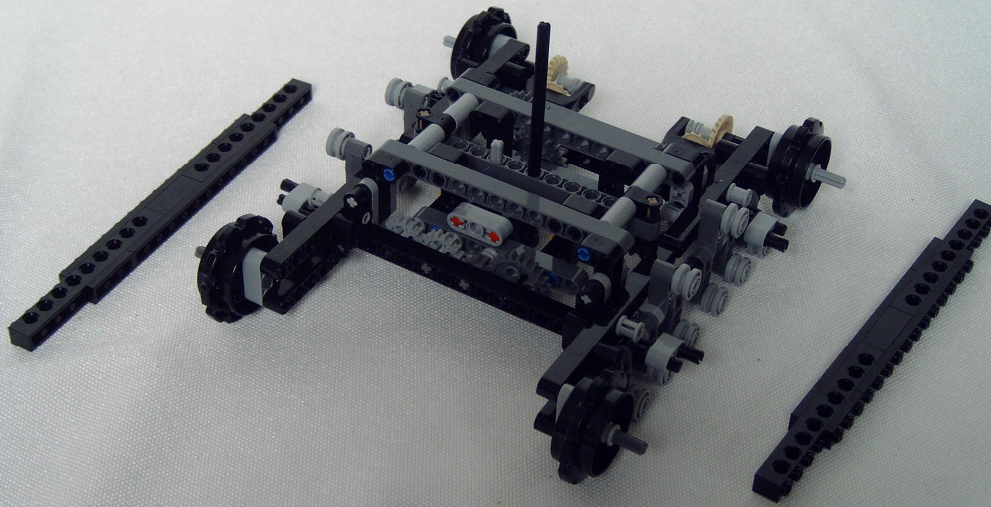

See step 25
(Book 1, page 32)

16

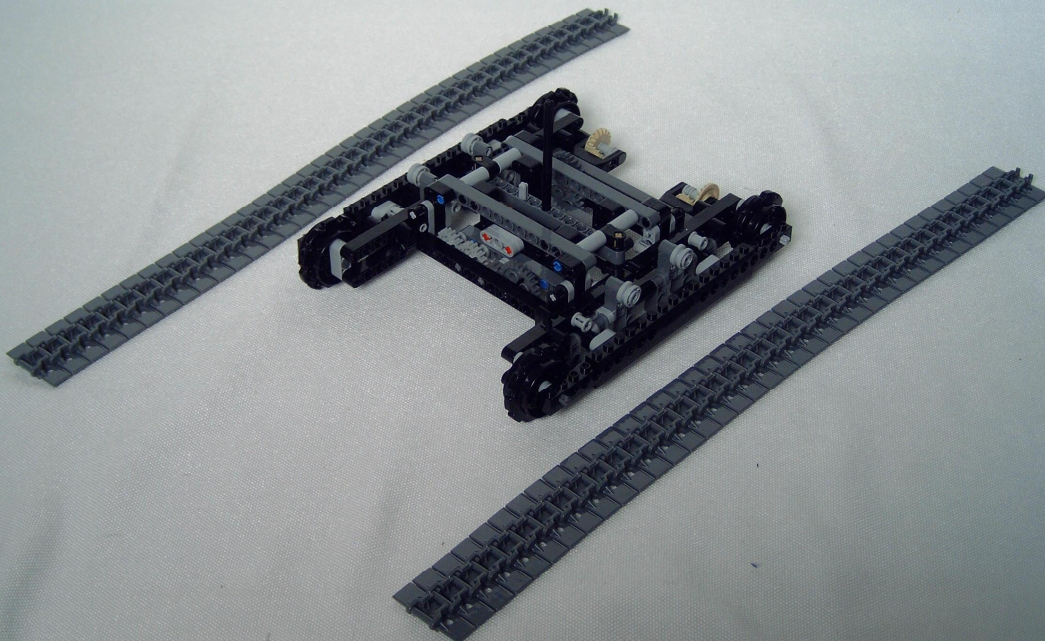

See step 26
(Book 1, page 33)

17

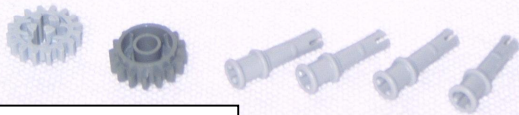
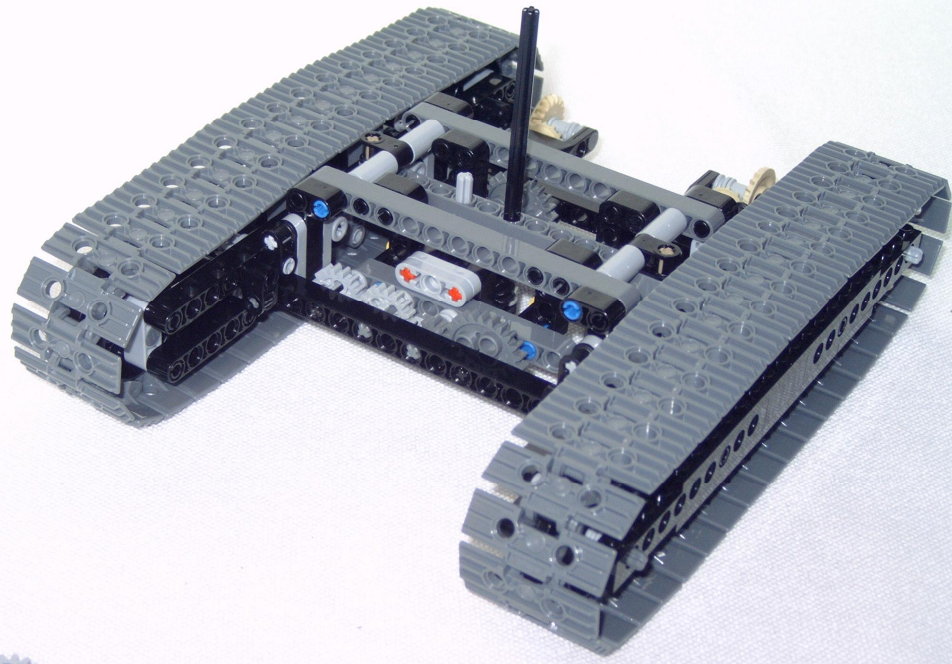

See step 27 - 28
(Book 1, page 34 - 35)

18

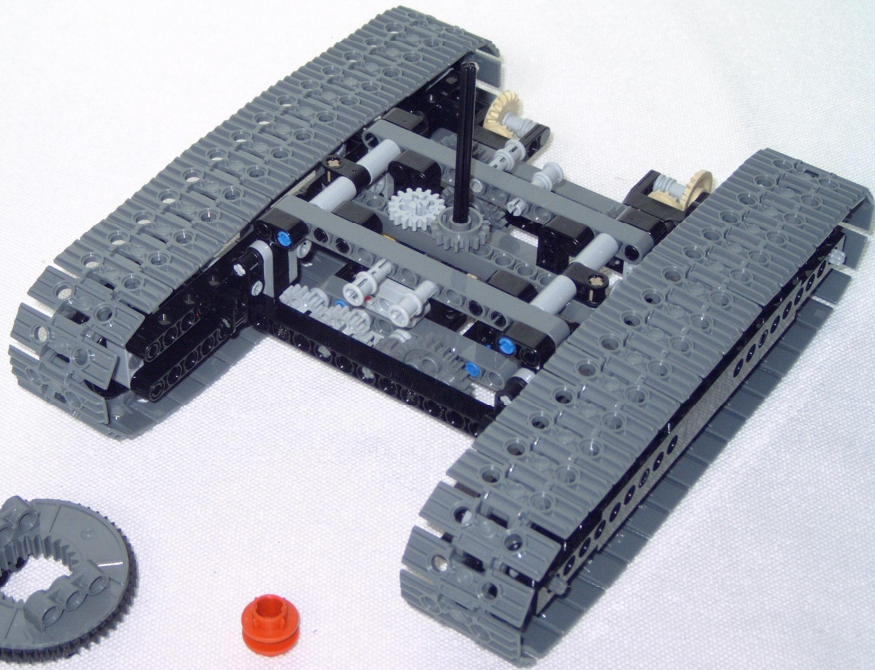

19

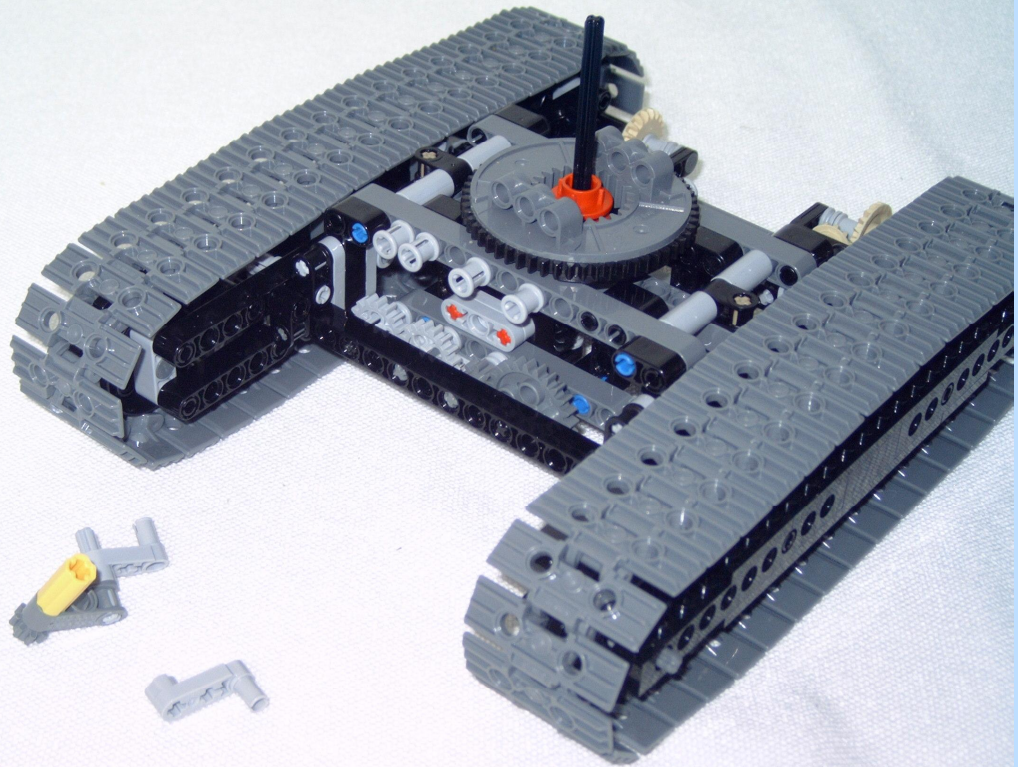

See step 1 - 7
(Book 1, page 36 - 37)

20

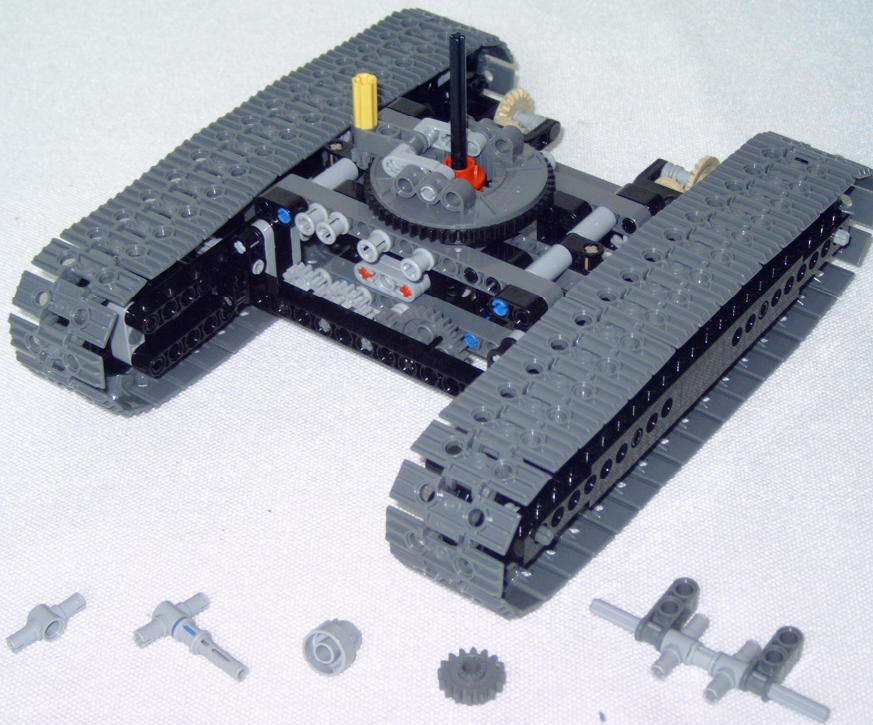

See step 31 - 32
(Book 1, page 39 - 40)

21

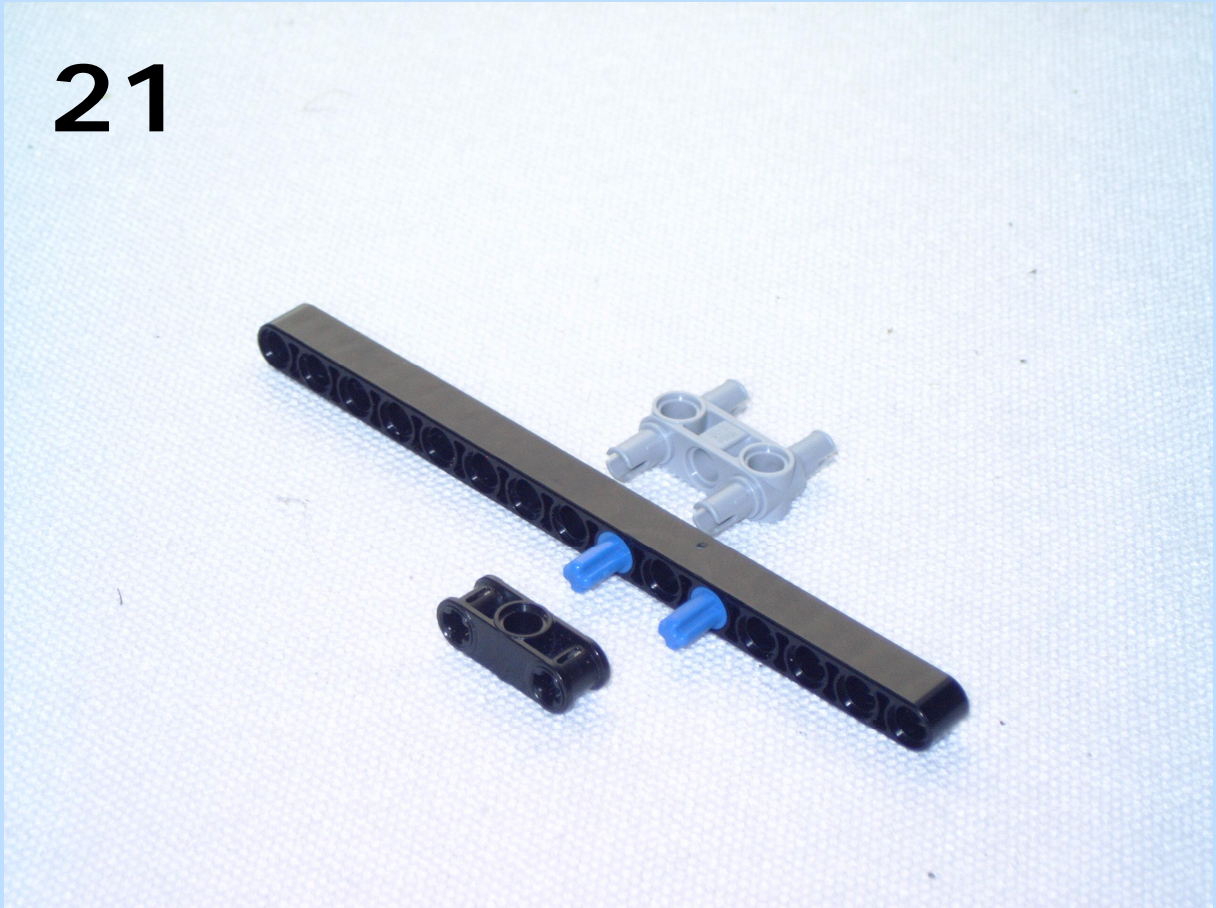

22

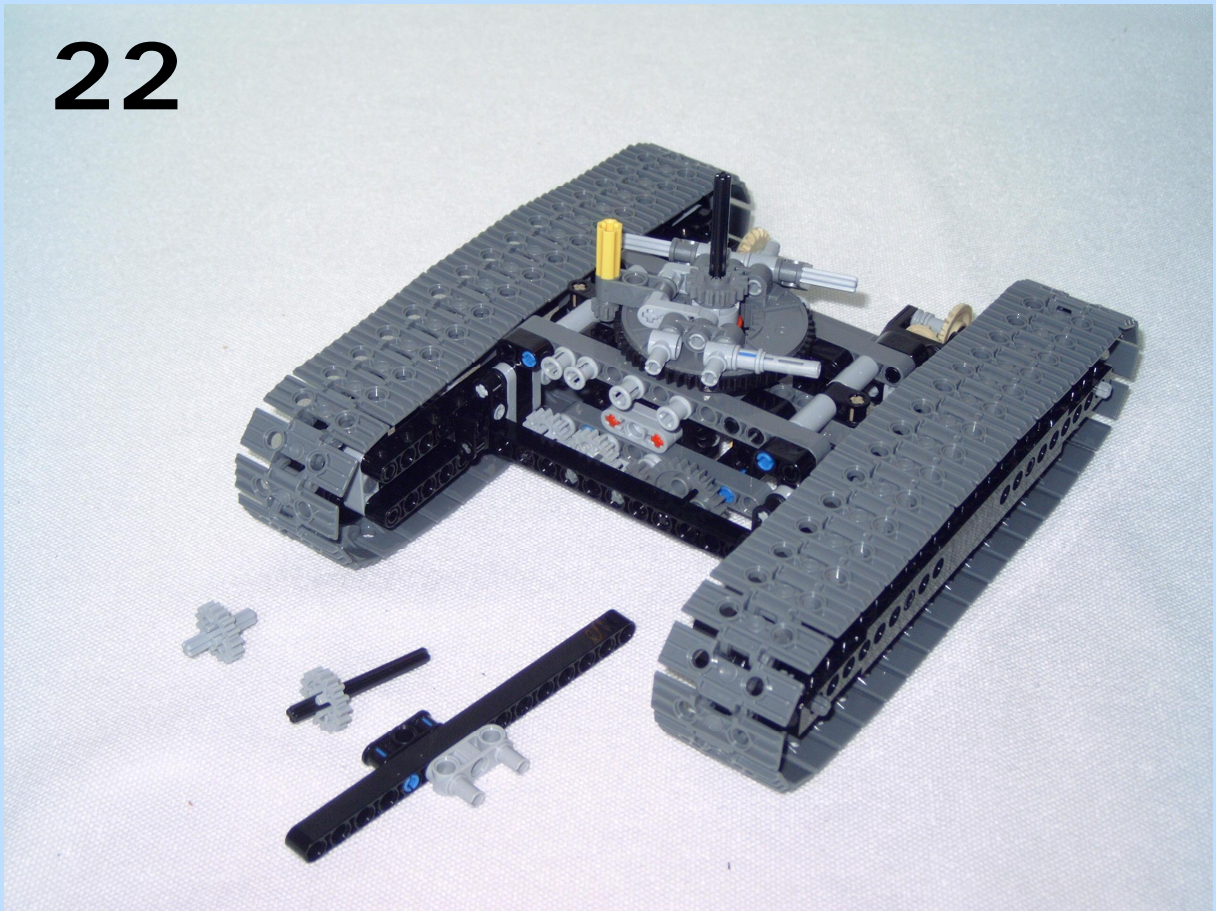

23

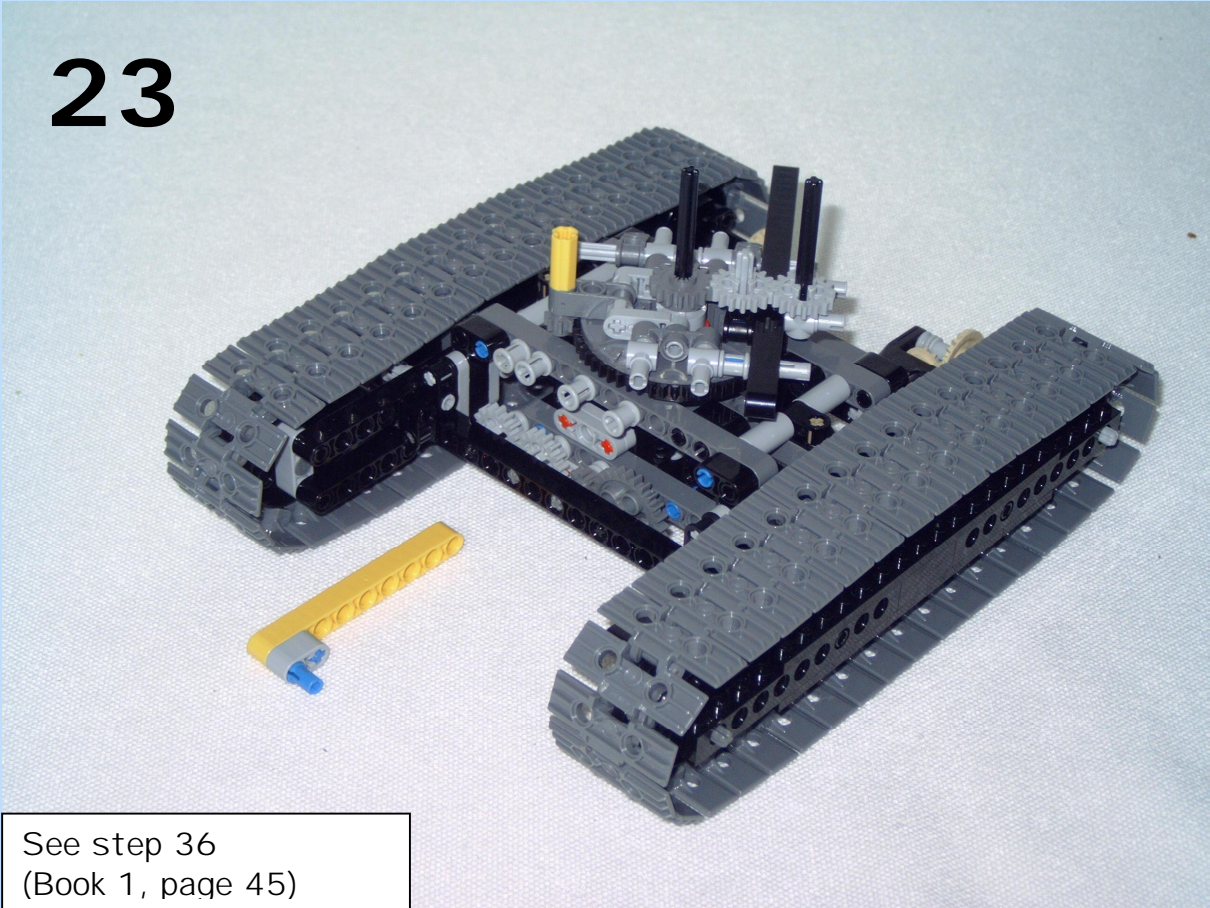

See step 36
(Book 1, page 45)

24

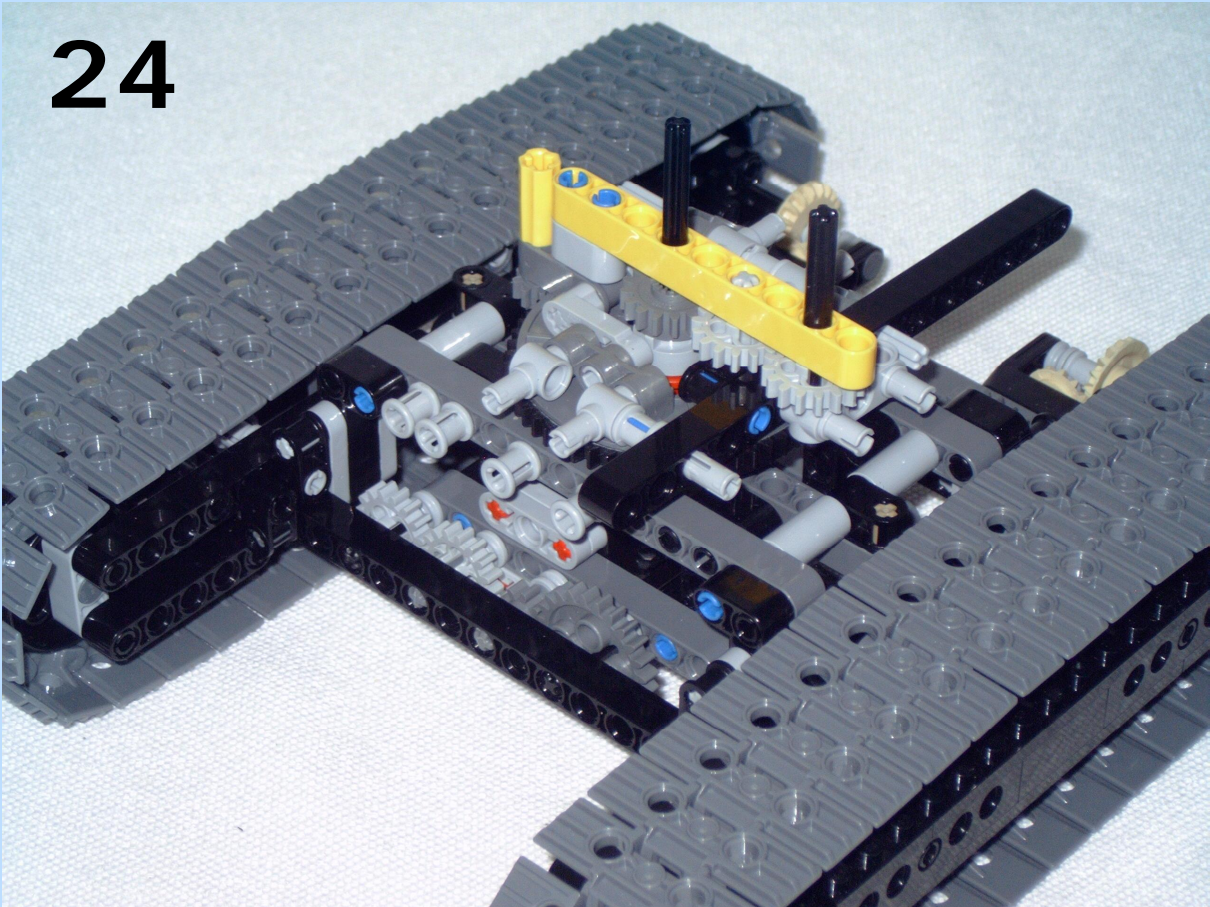

25

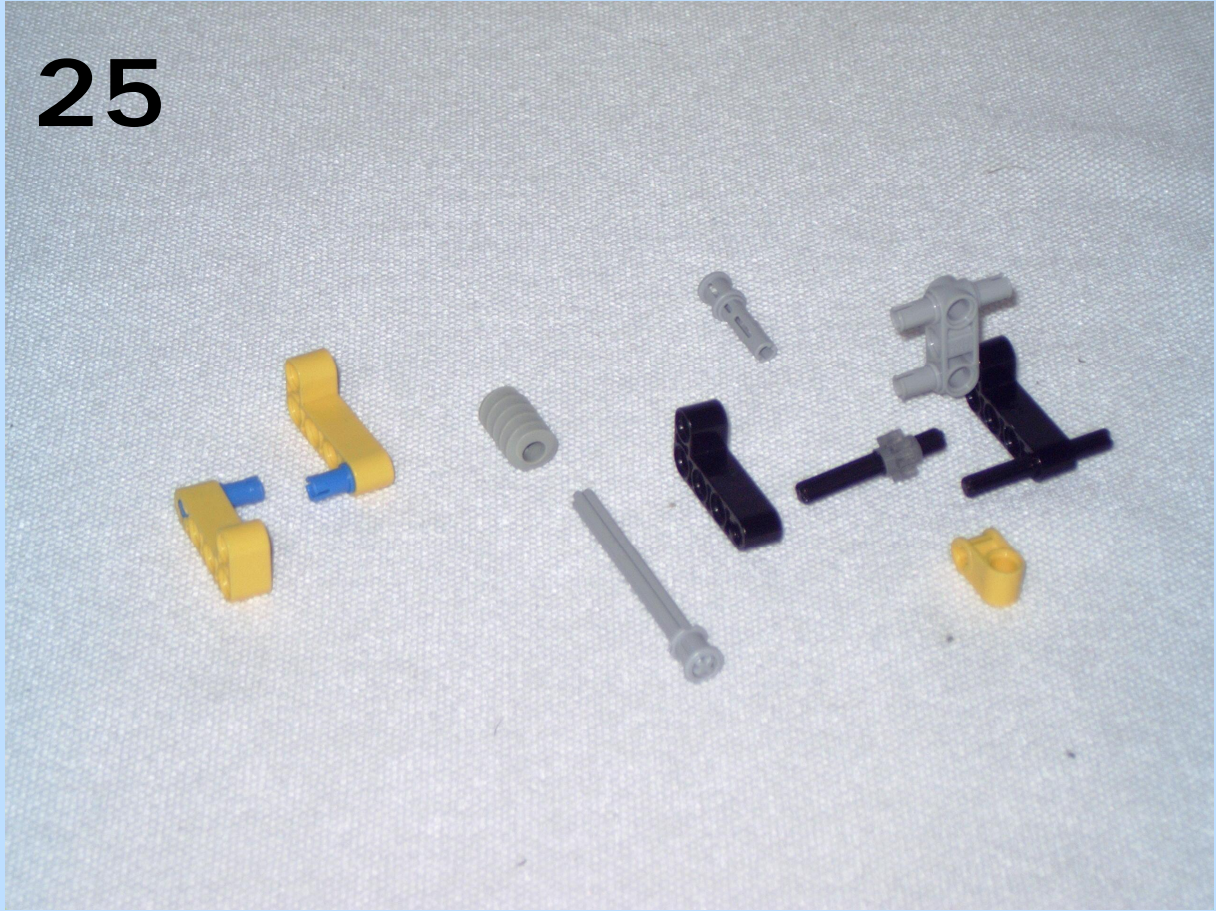

26

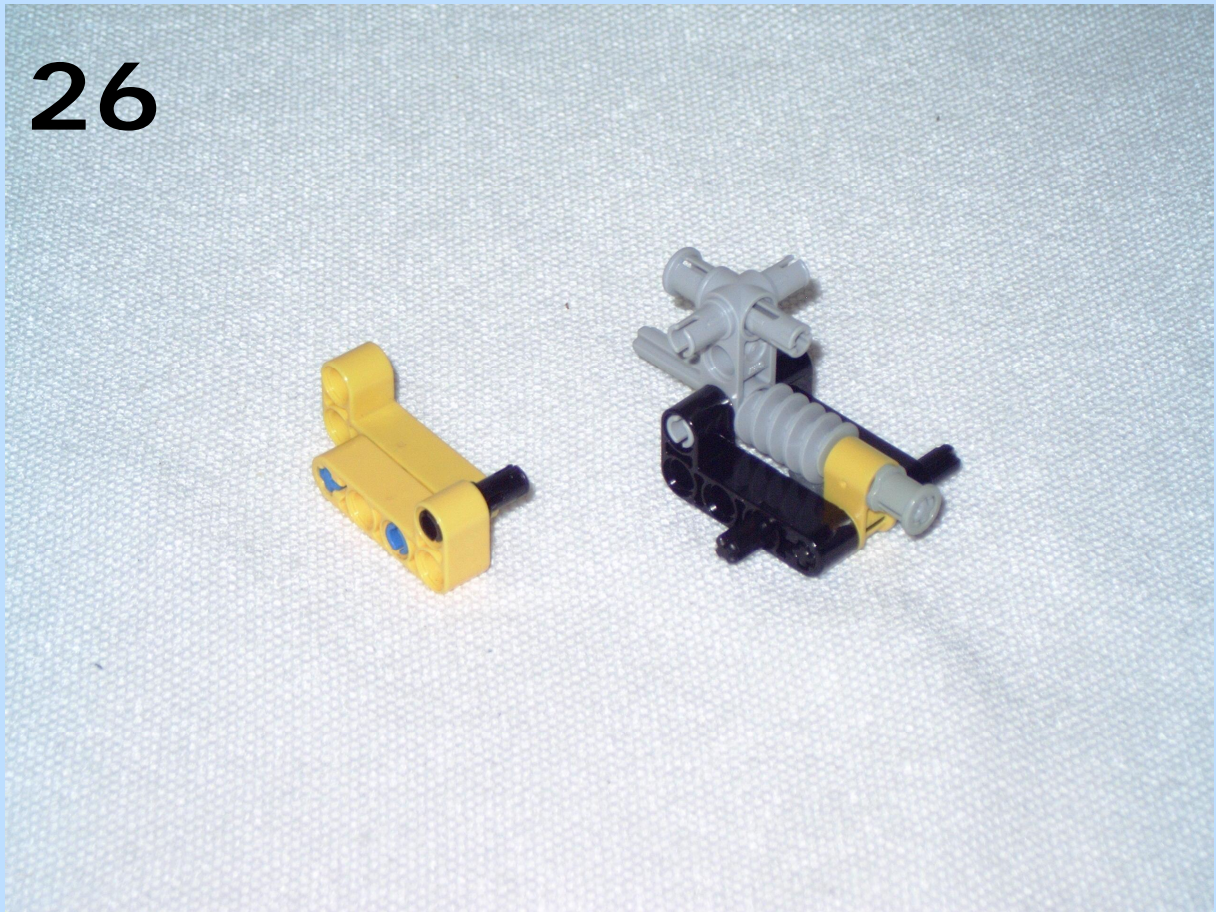

27

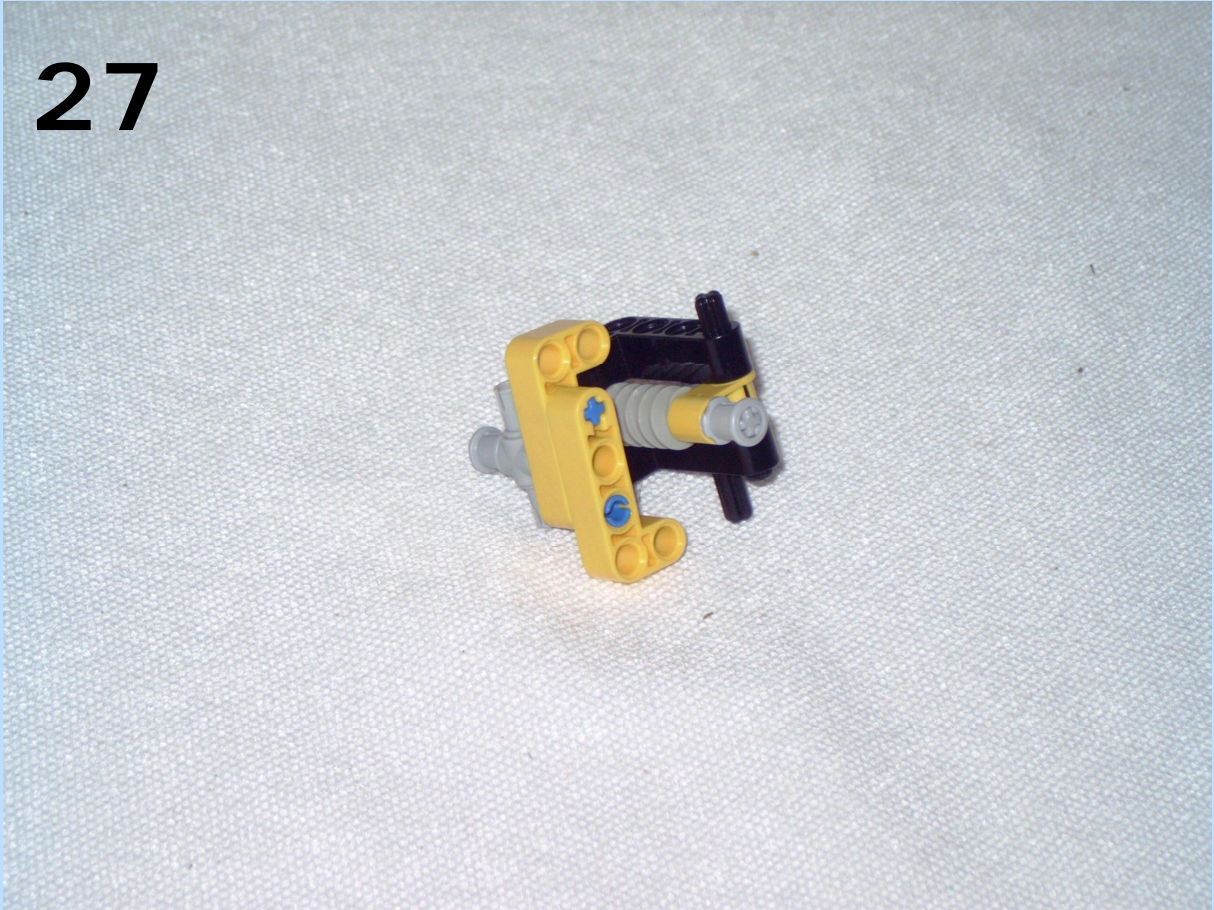

28

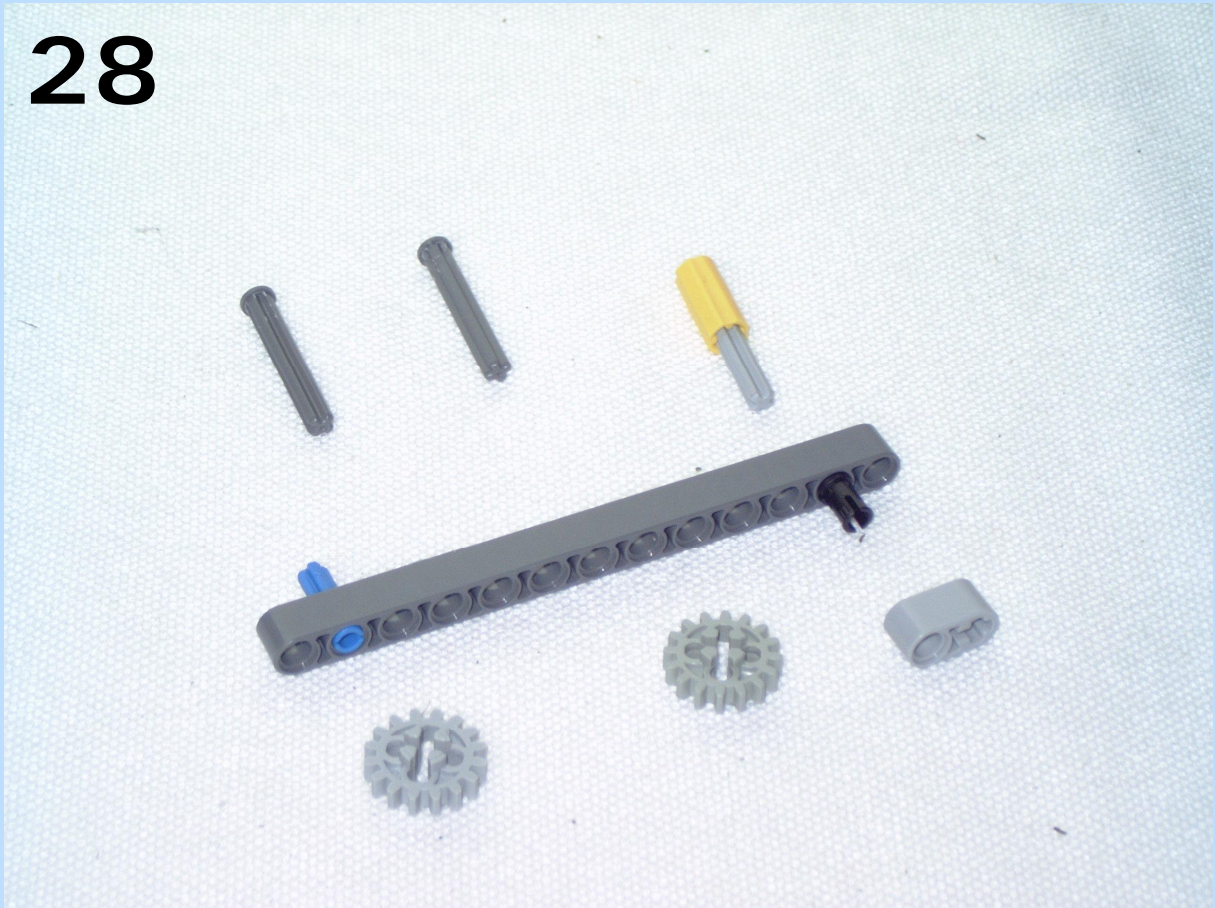

29

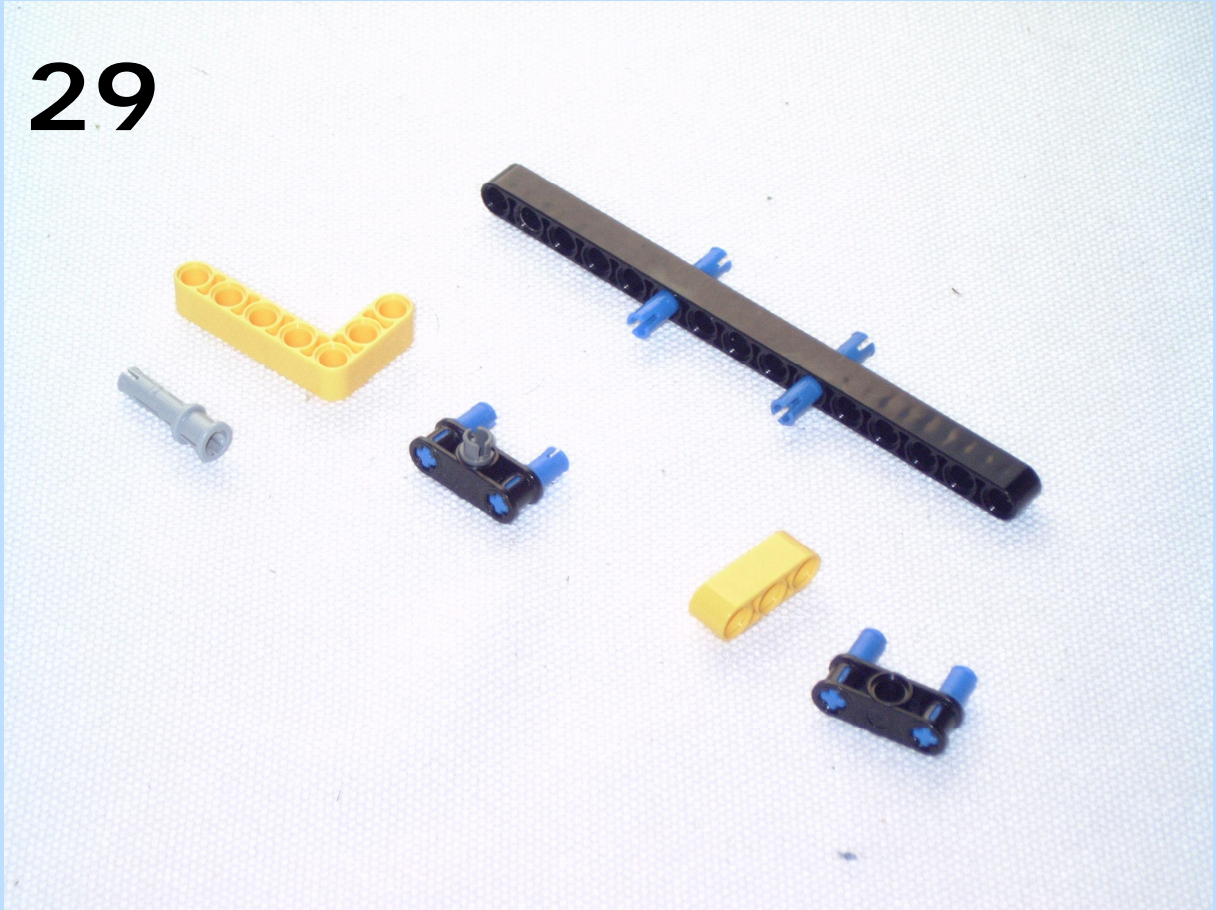

30

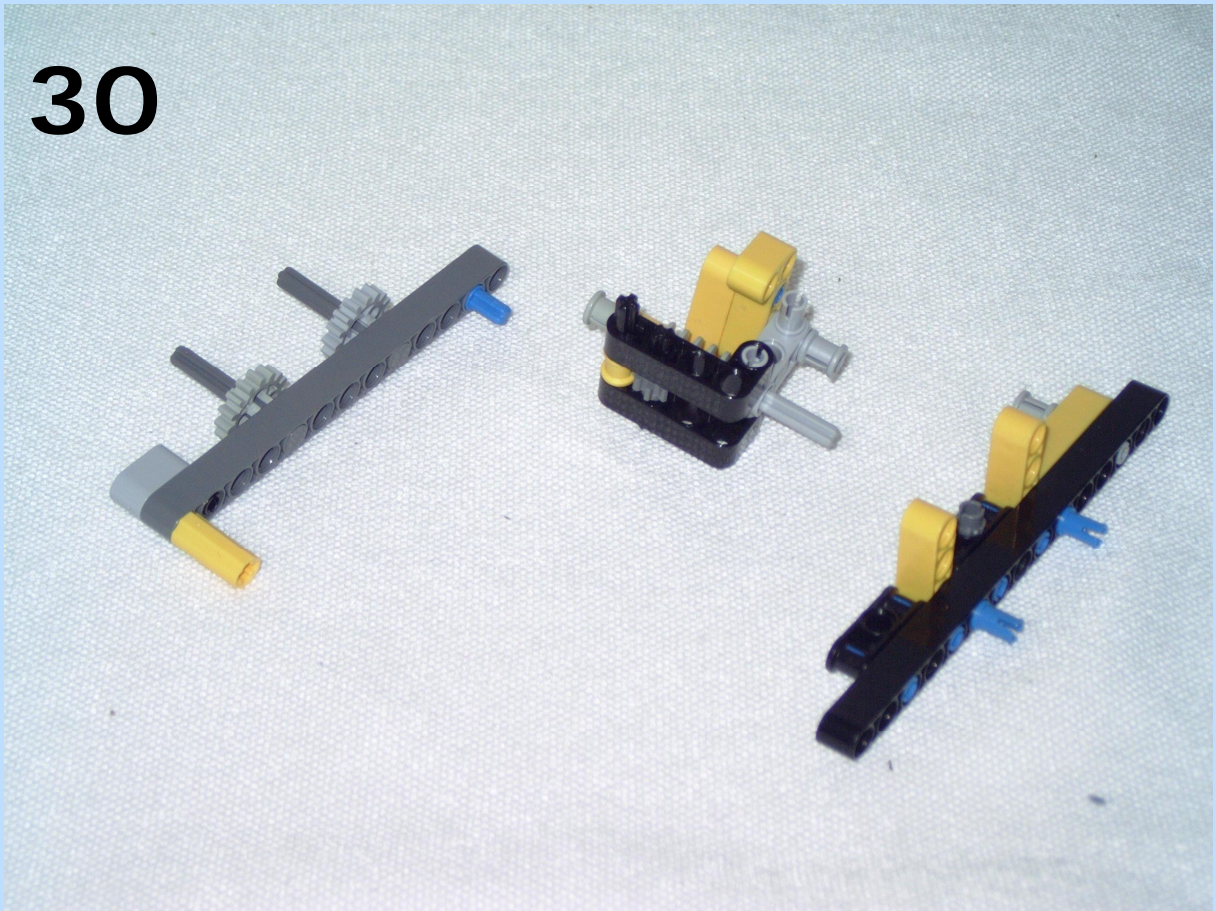

31

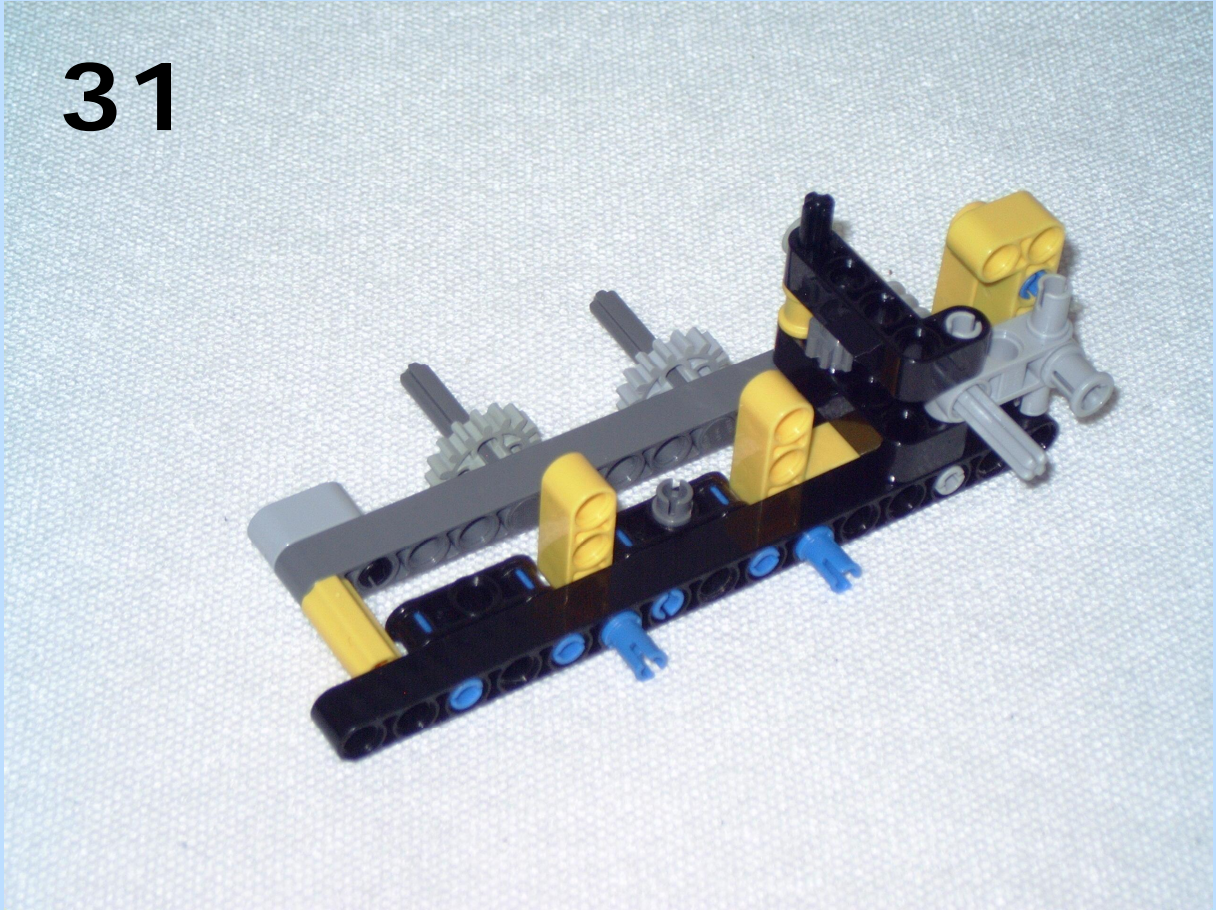

32

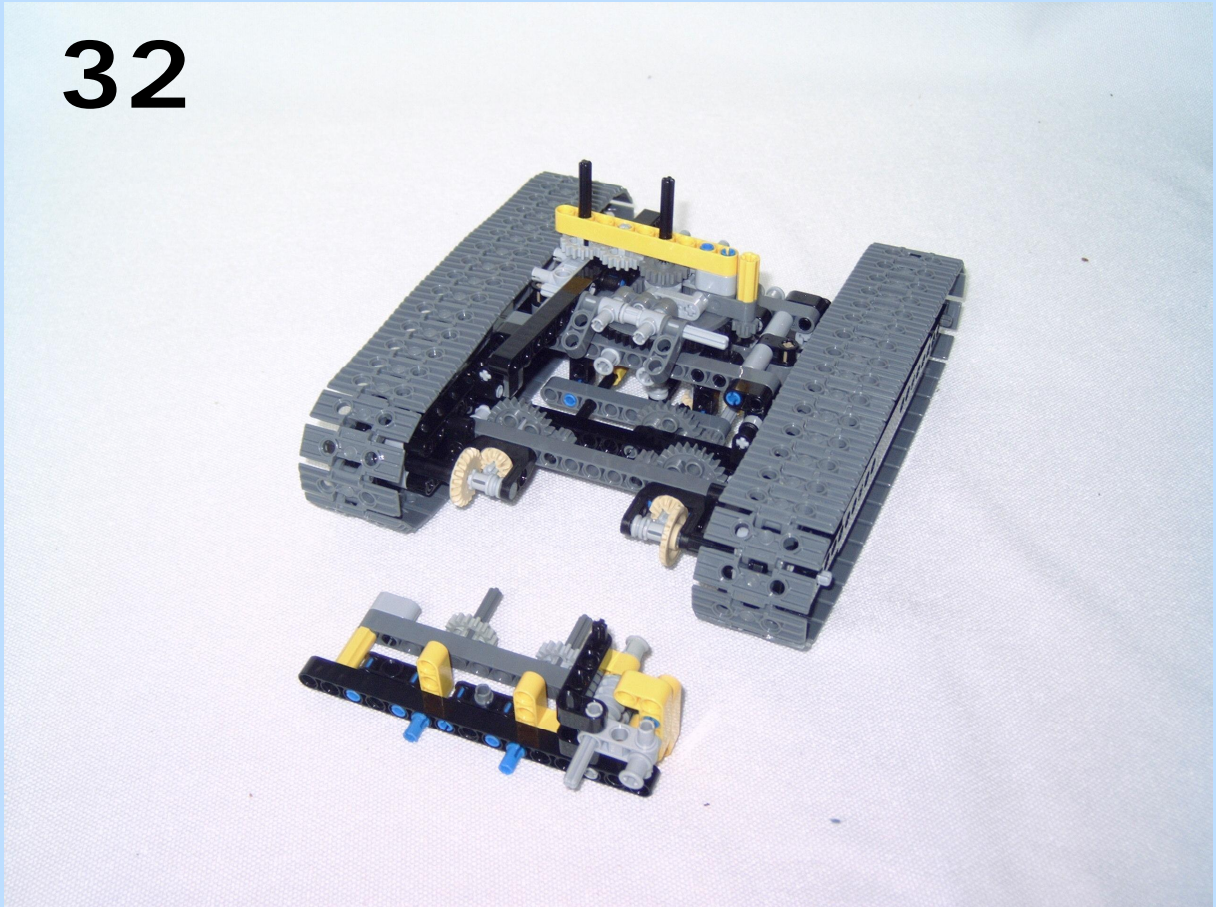

33

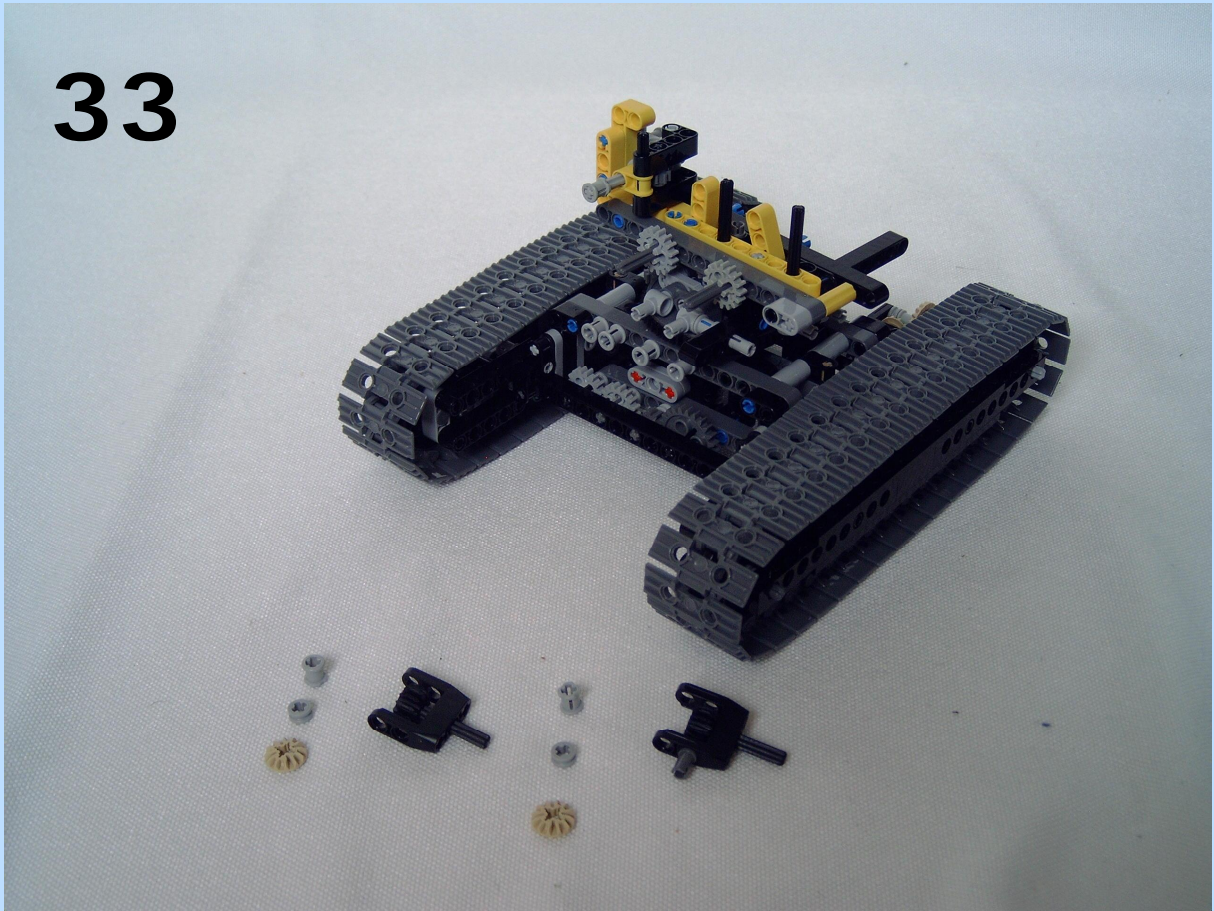

34

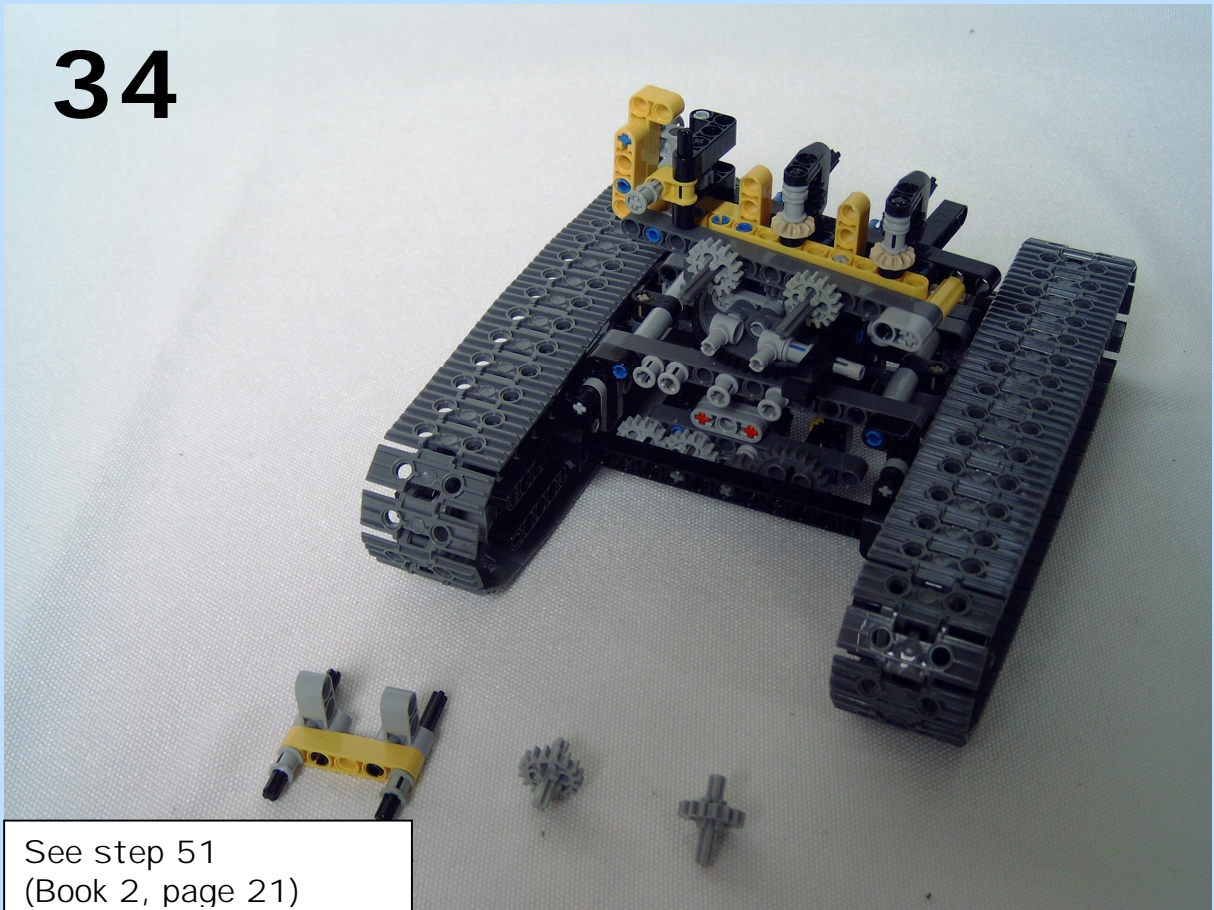

See step 51
(Book 2, page 21)

35

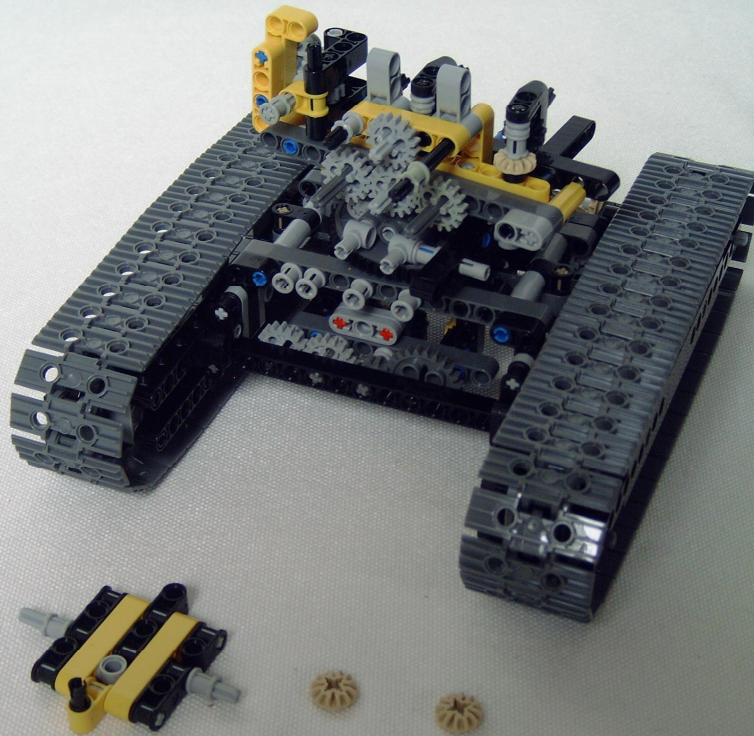

See step 1 - 8
(Book 2, page 24 - 26)

36

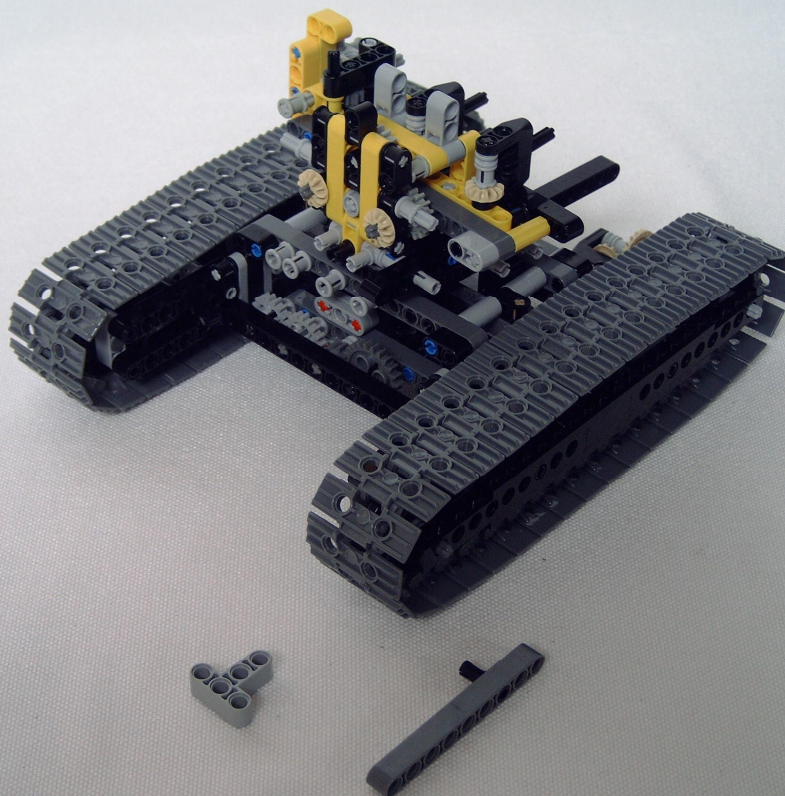

37

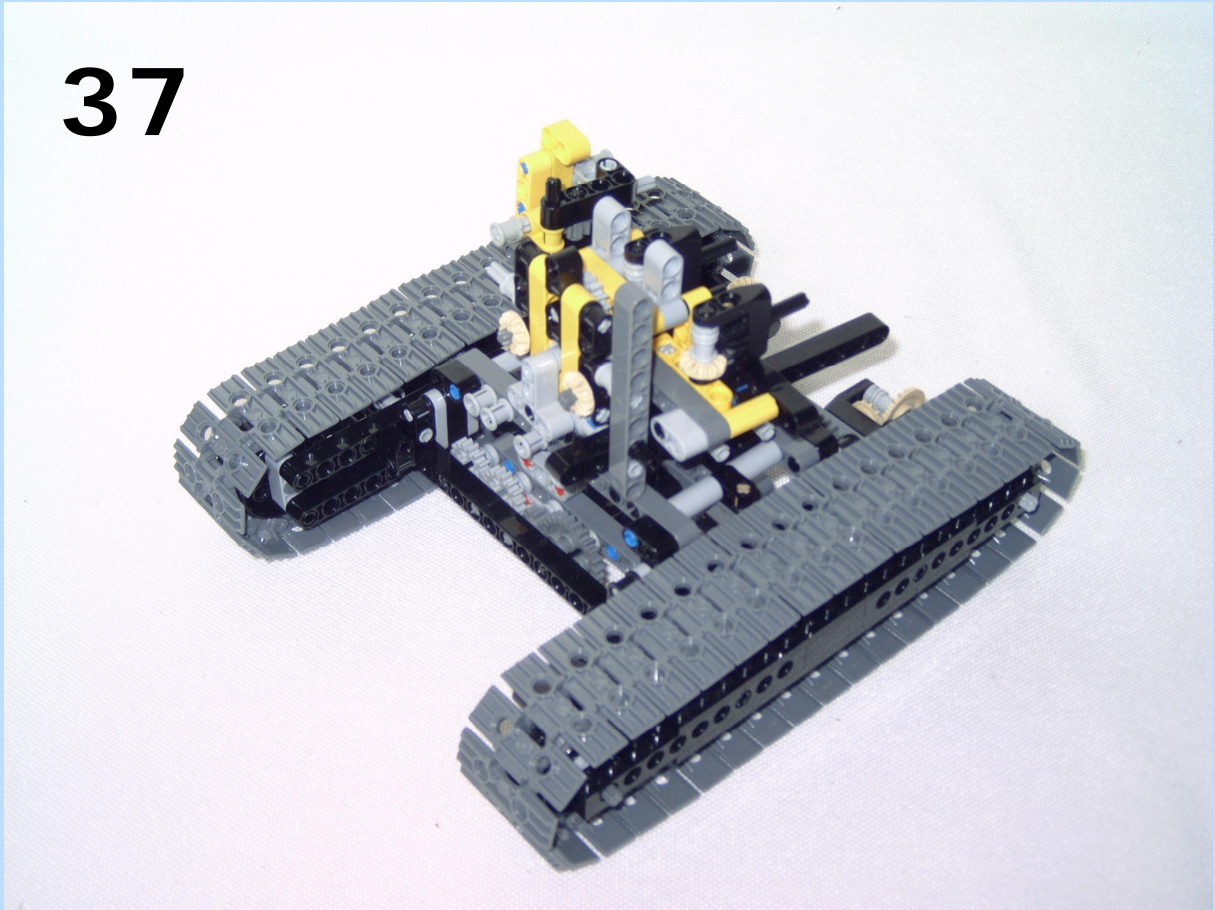

38

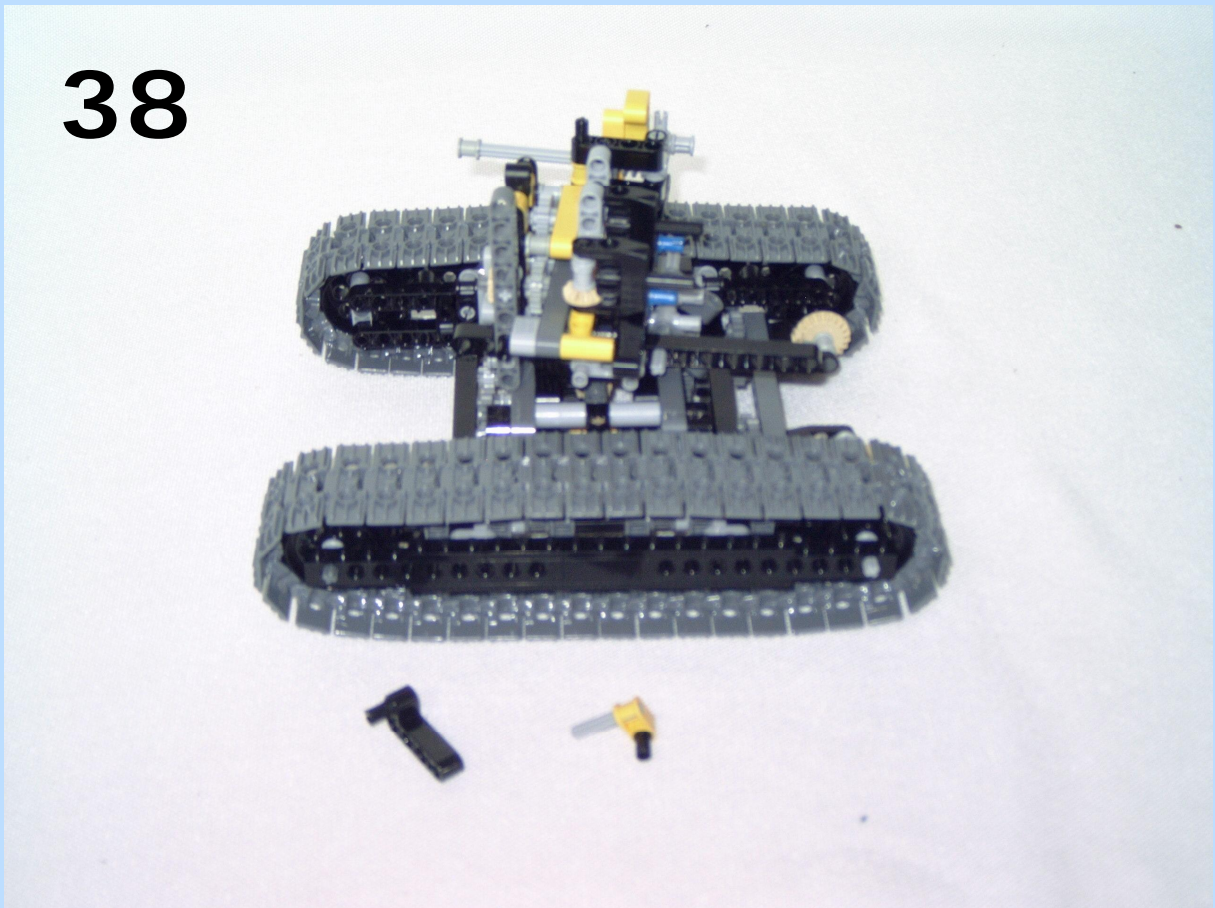

39

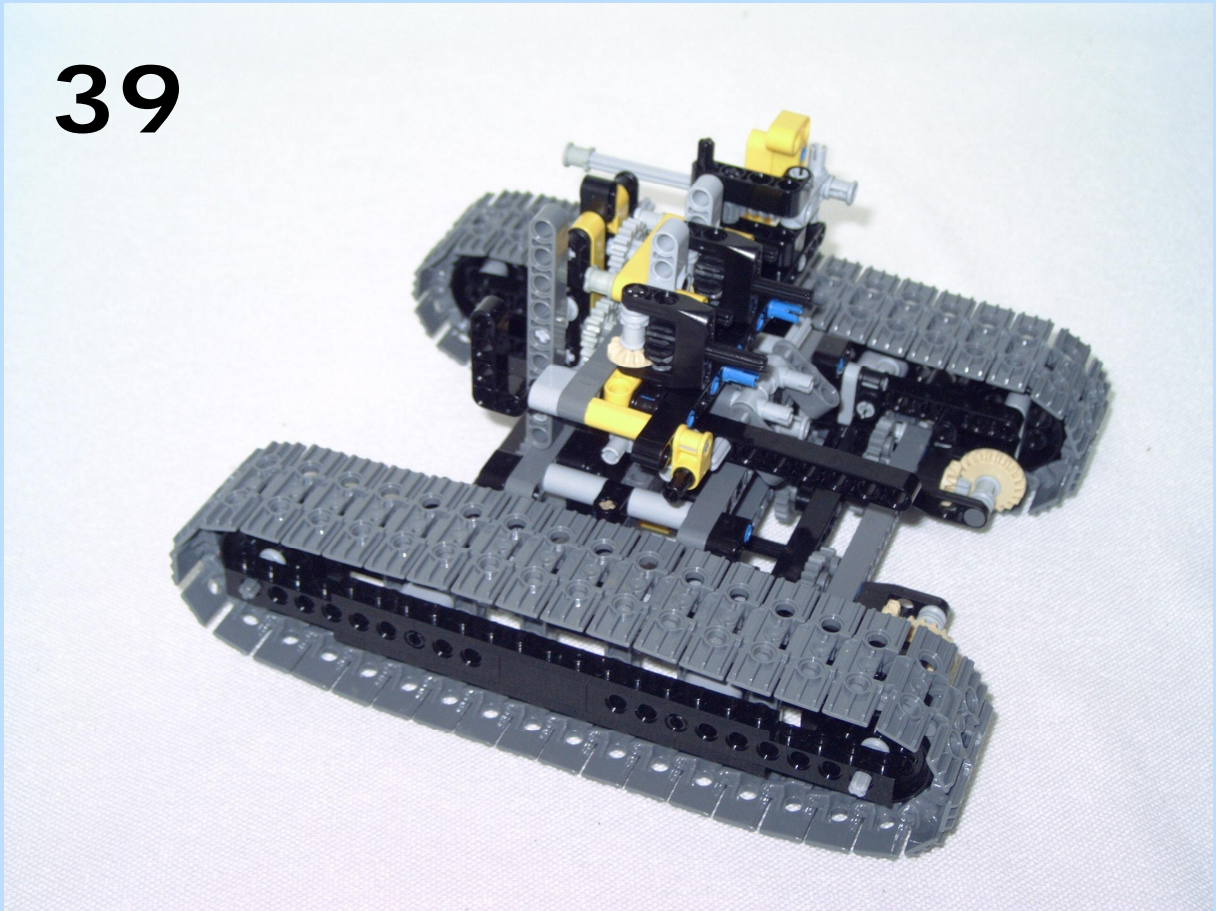

40

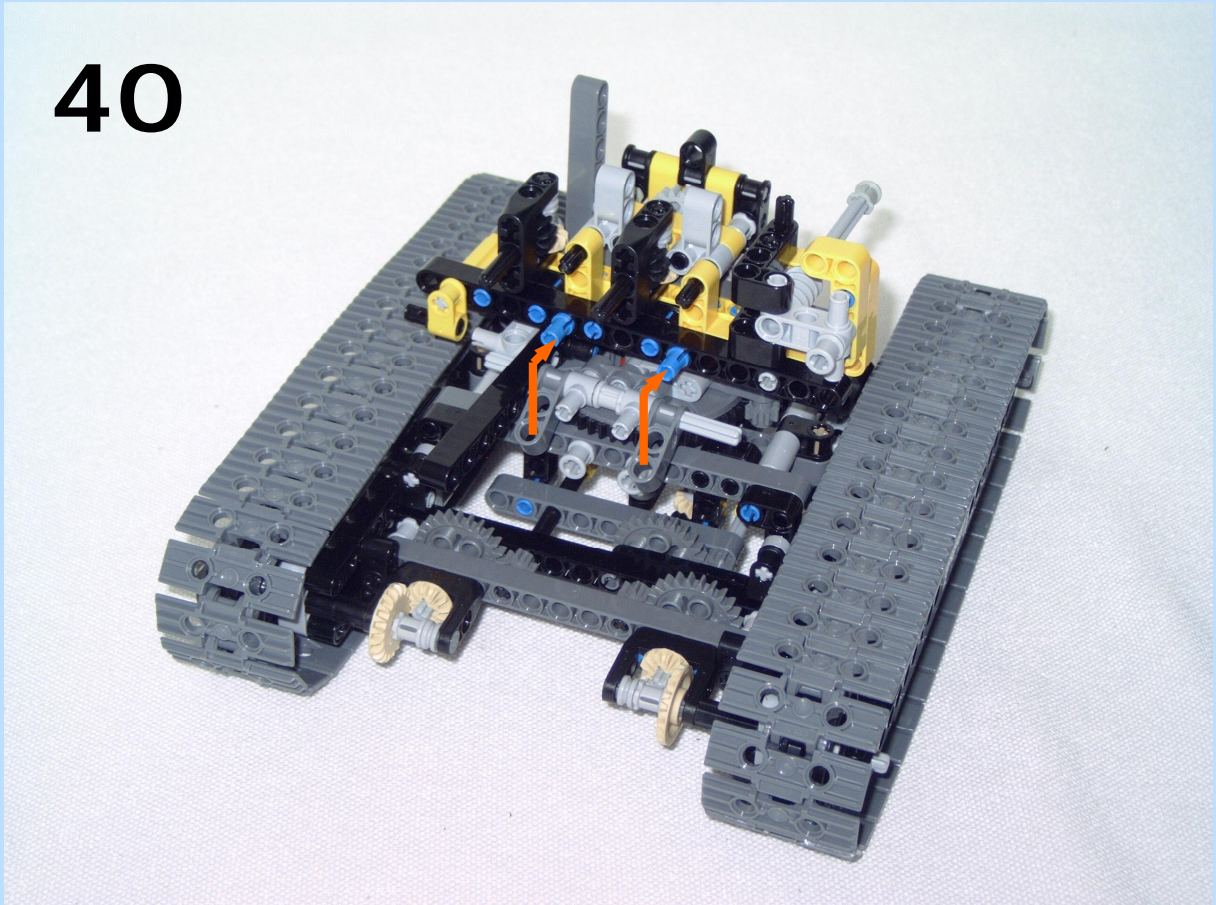

41

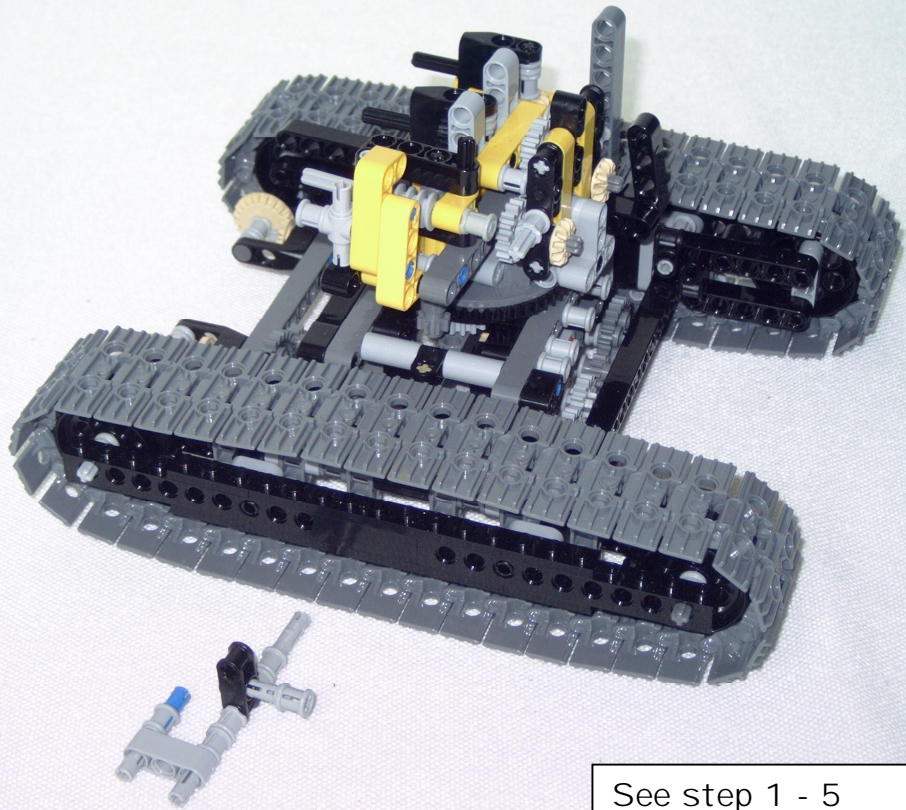

See step 1 - 5
(Book 2, page 28 - 29)

42

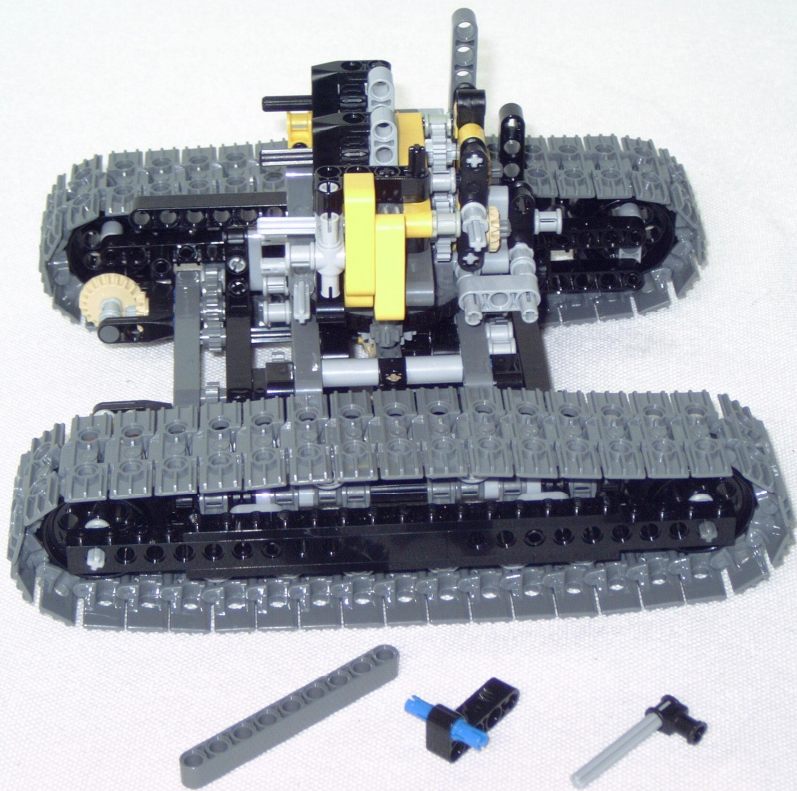

43

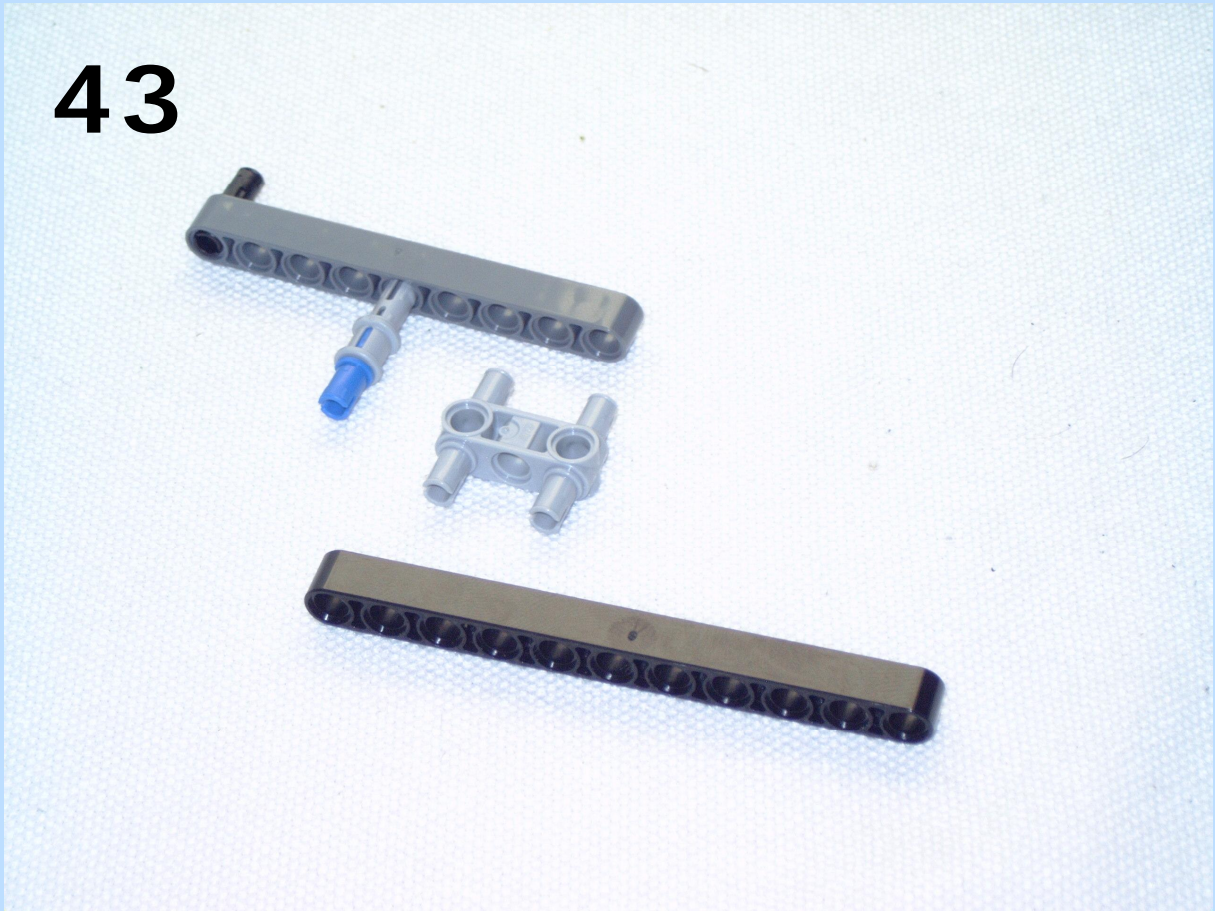

44

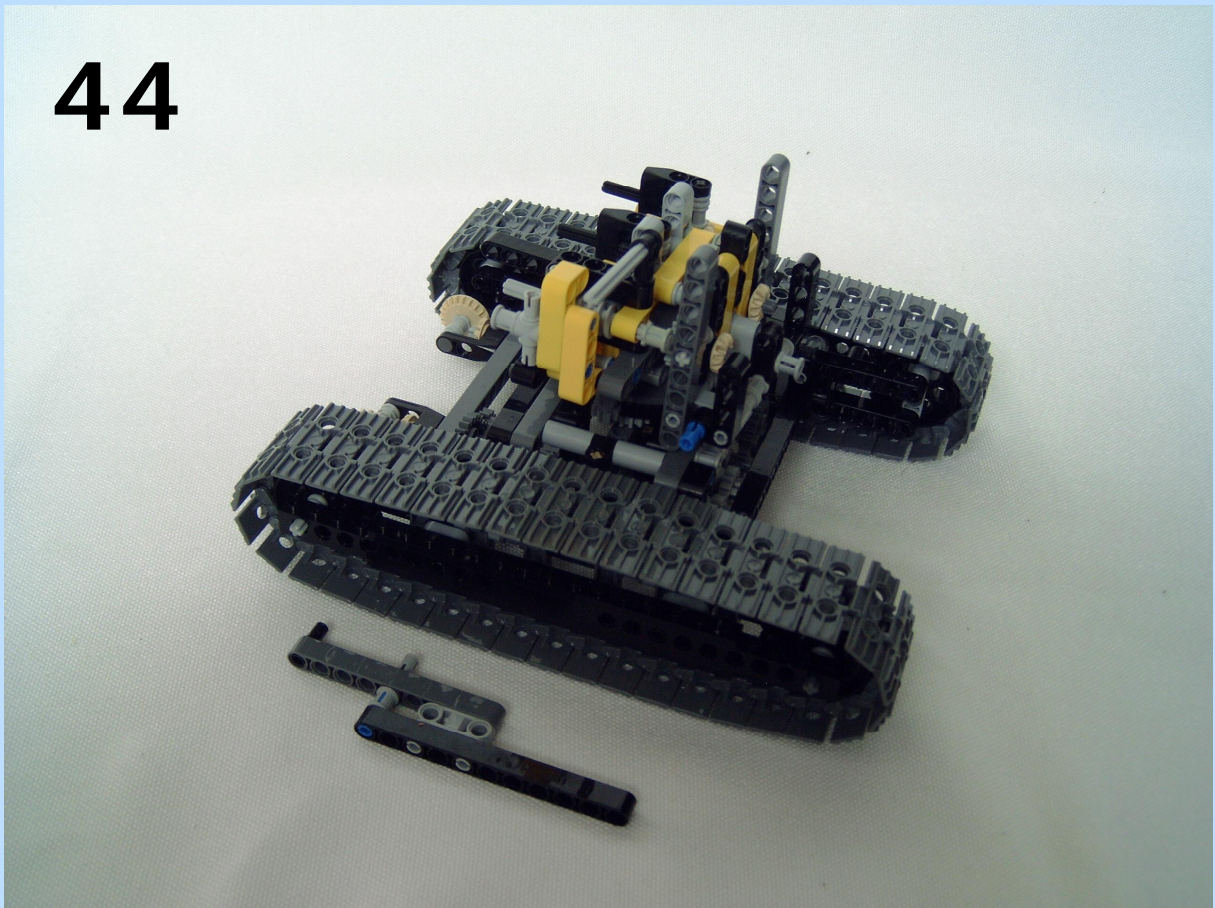

Replace step 1 - 15, book 2, pag.59 - 68 with this assembly

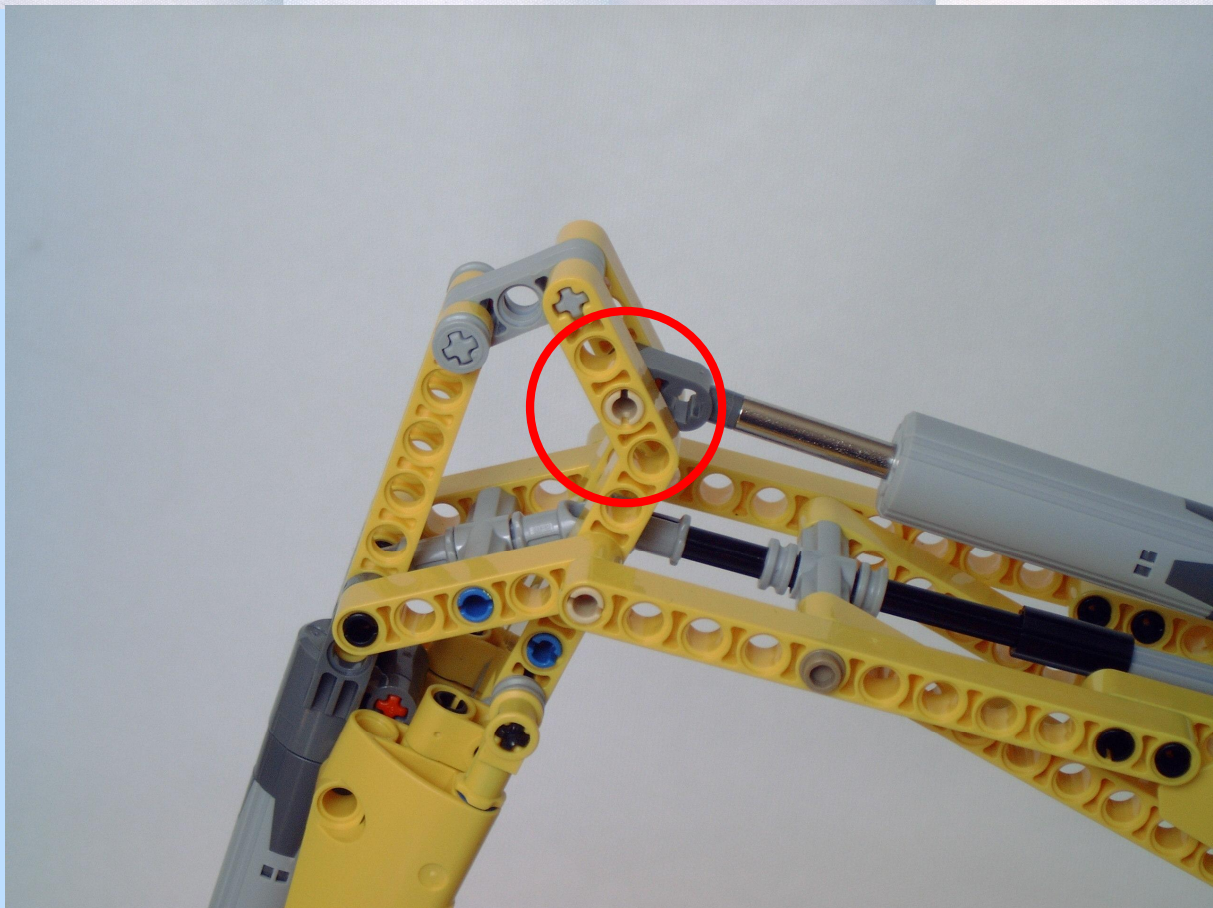

45

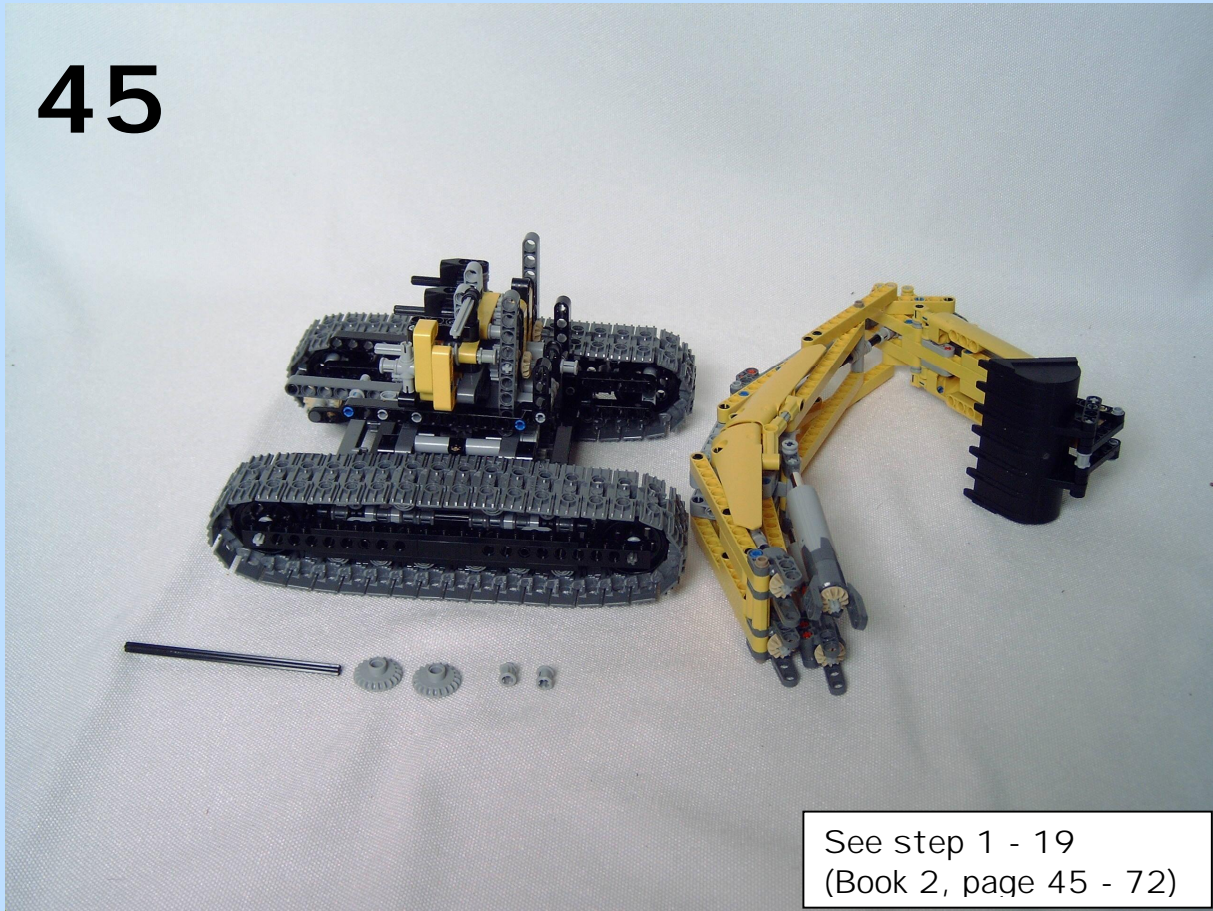

See step 1 - 19
(Book 2, page 45 - 72)

46

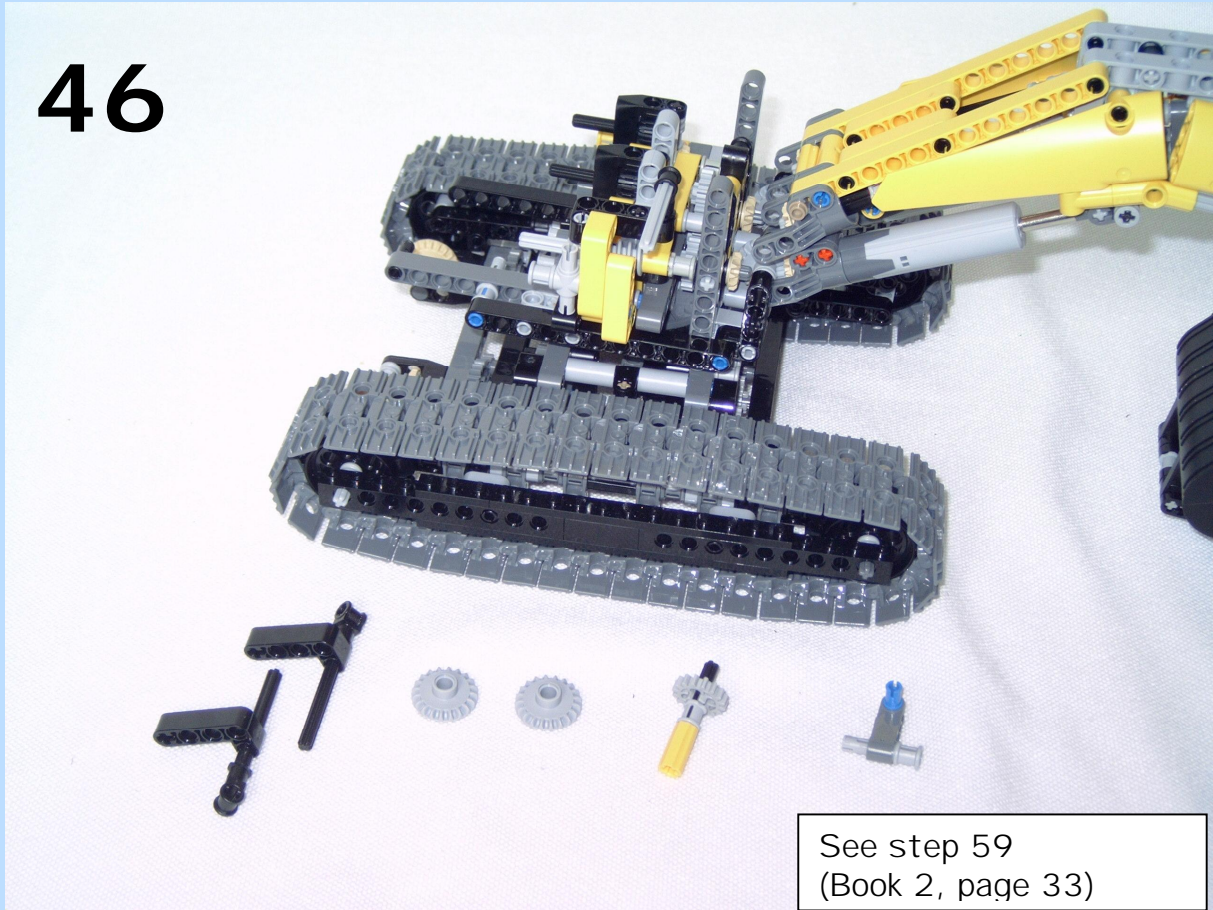

See step 59
(Book 2, page 33)

47

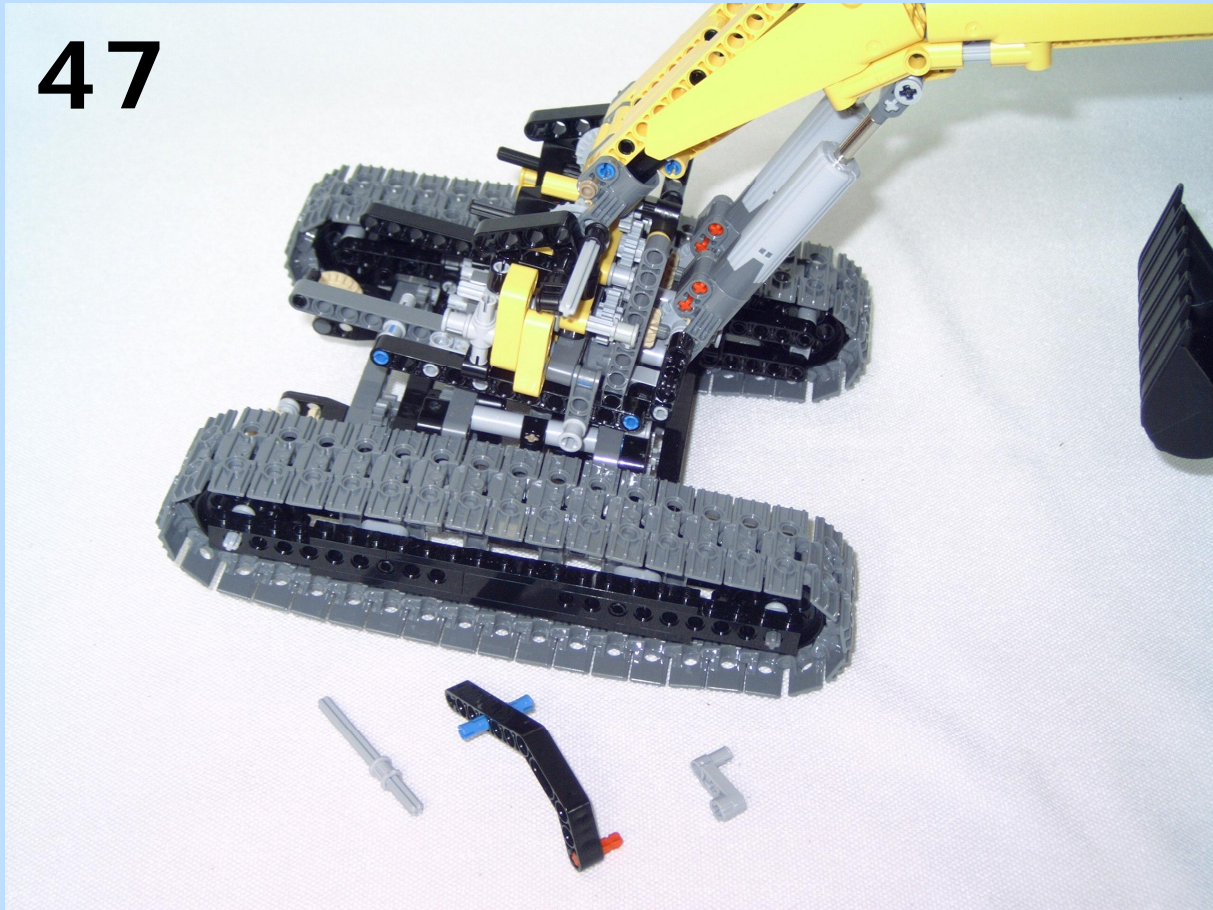

48

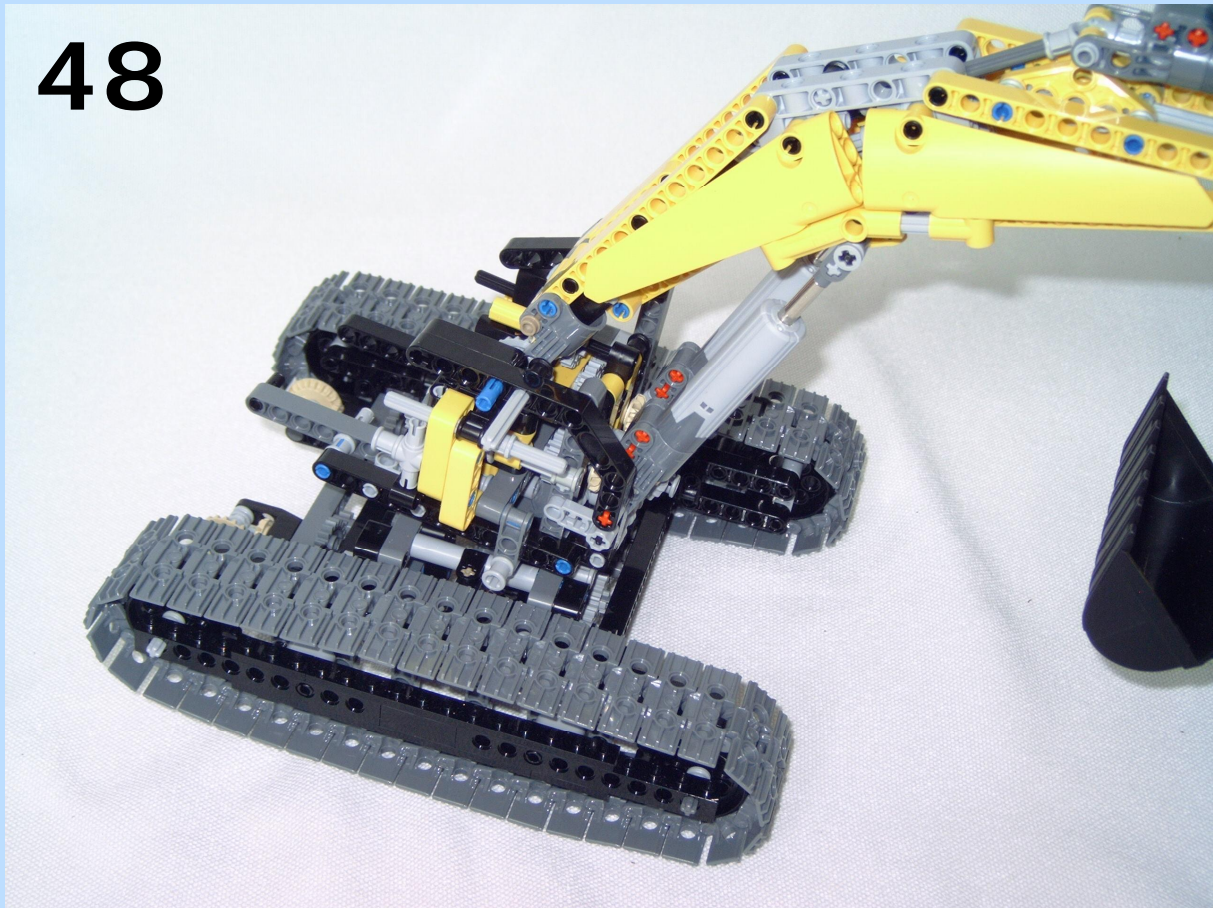

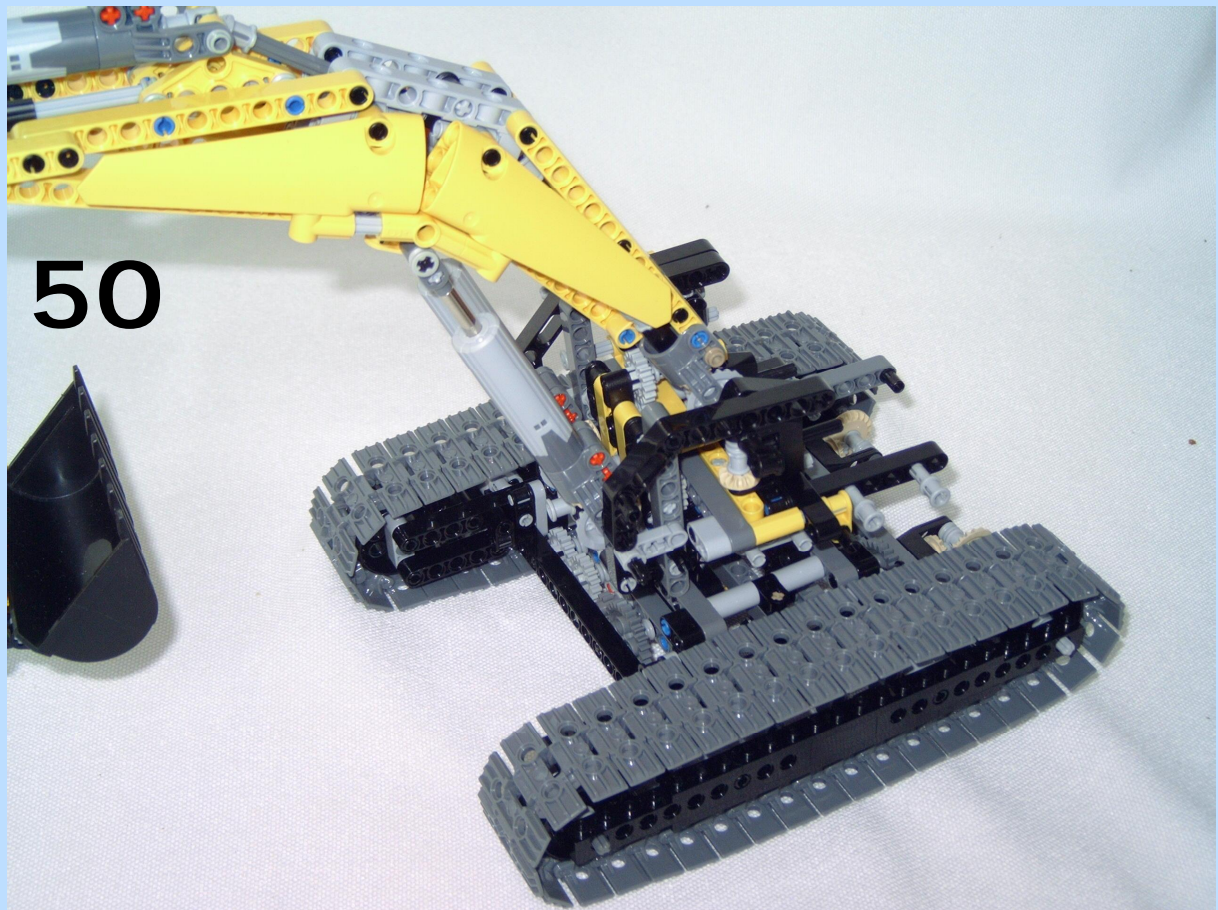
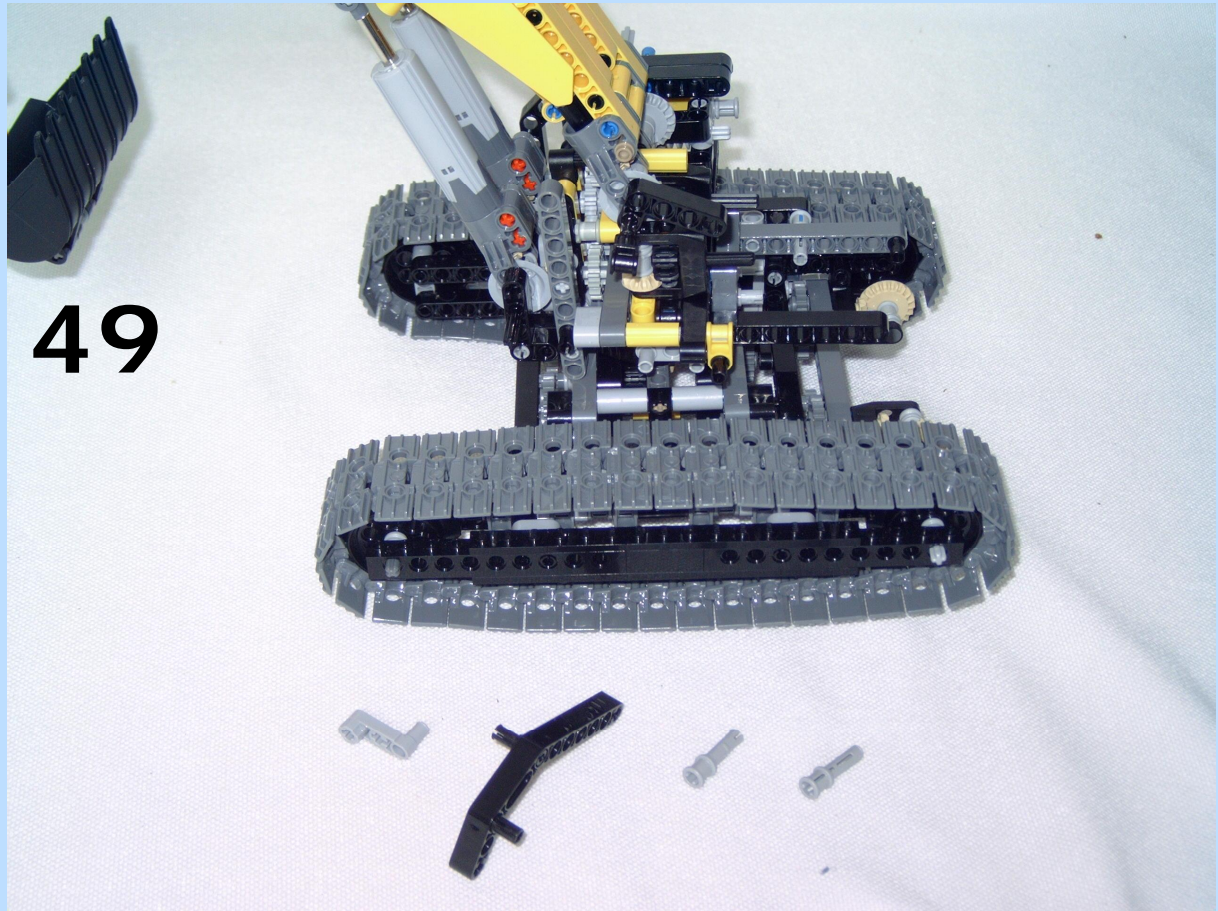

51

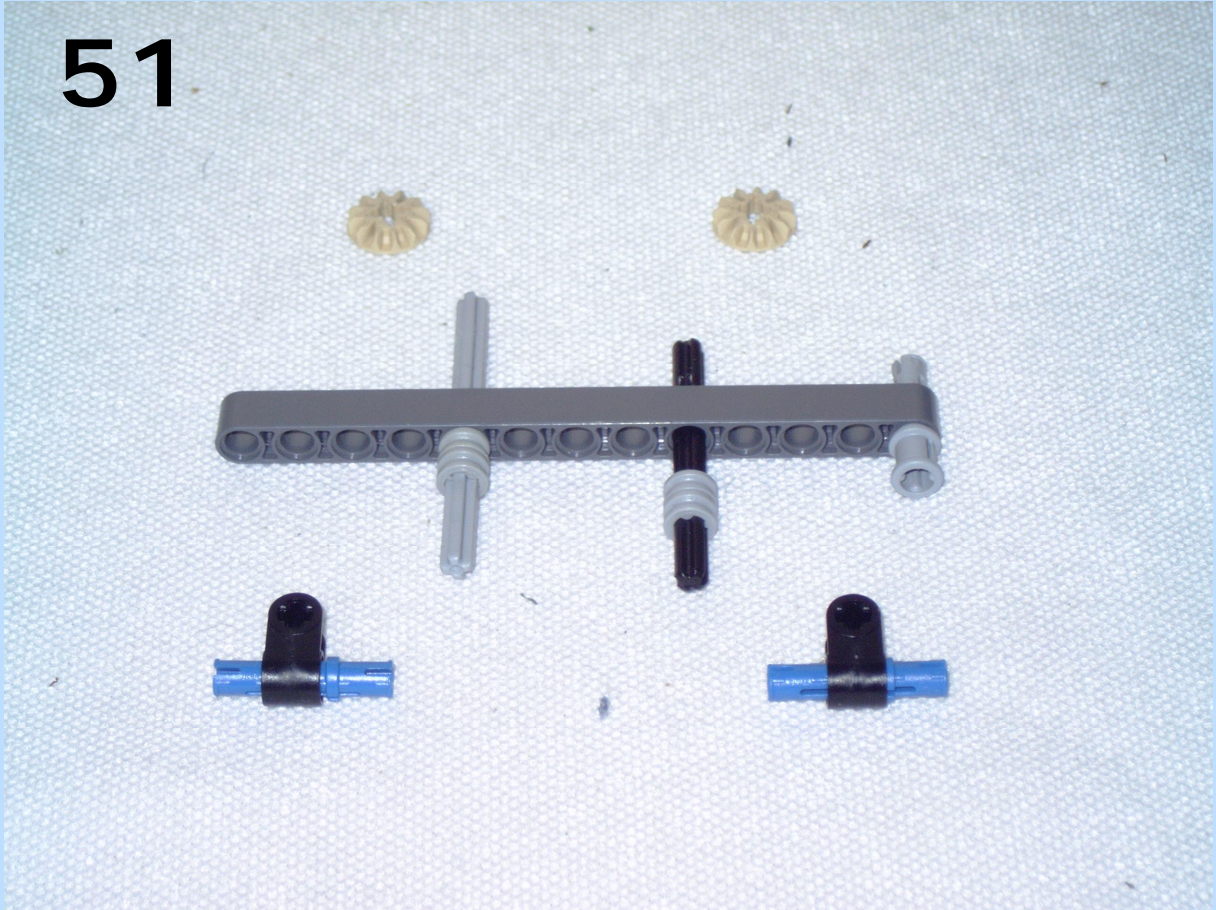

52

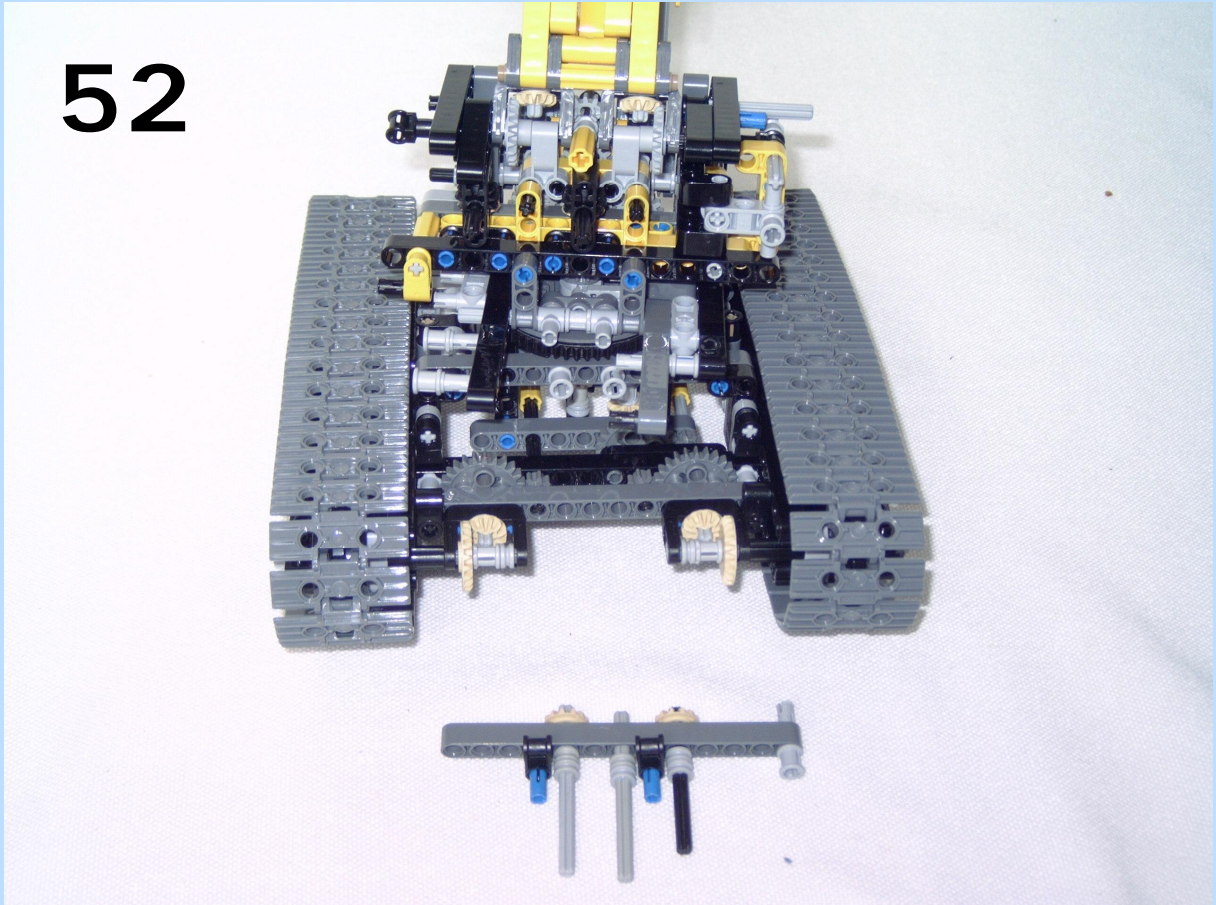

53

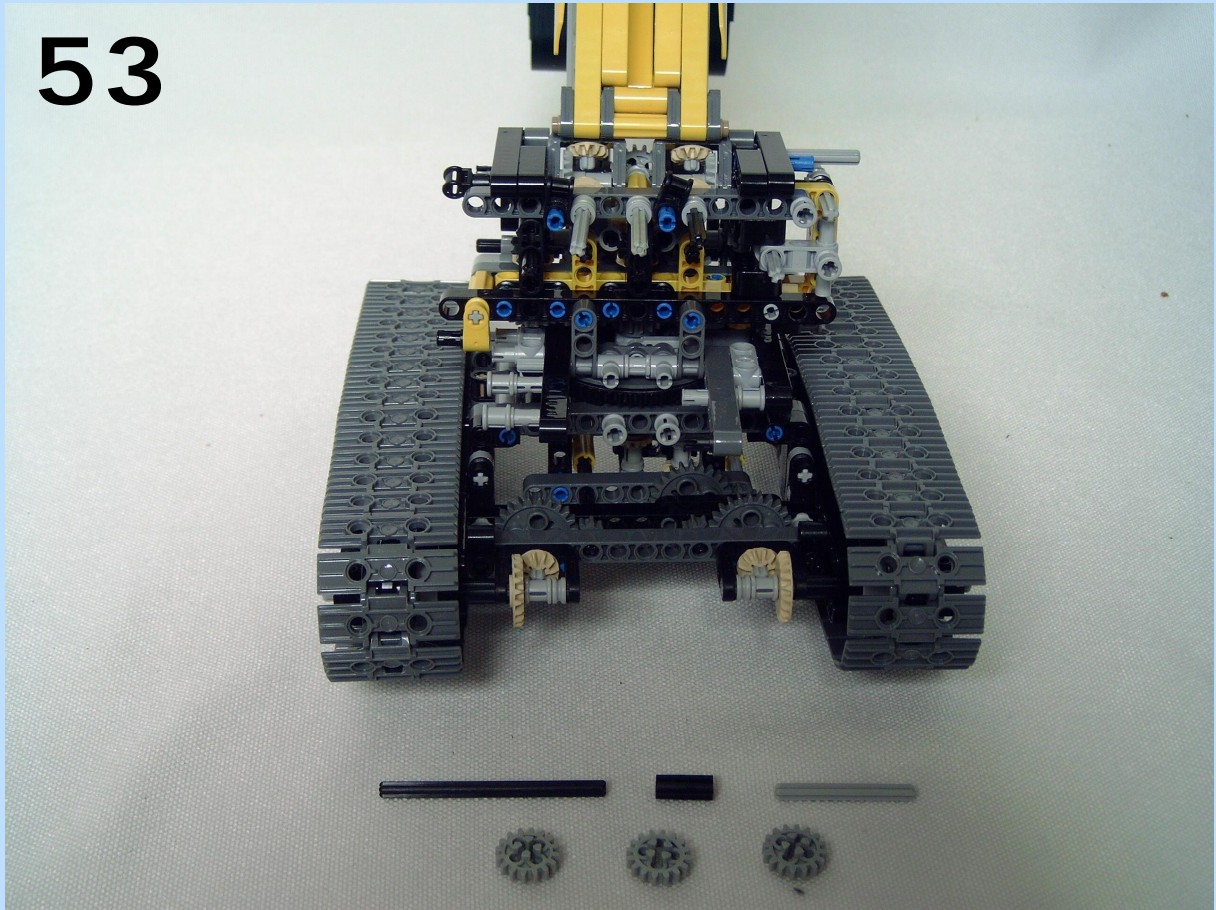

54

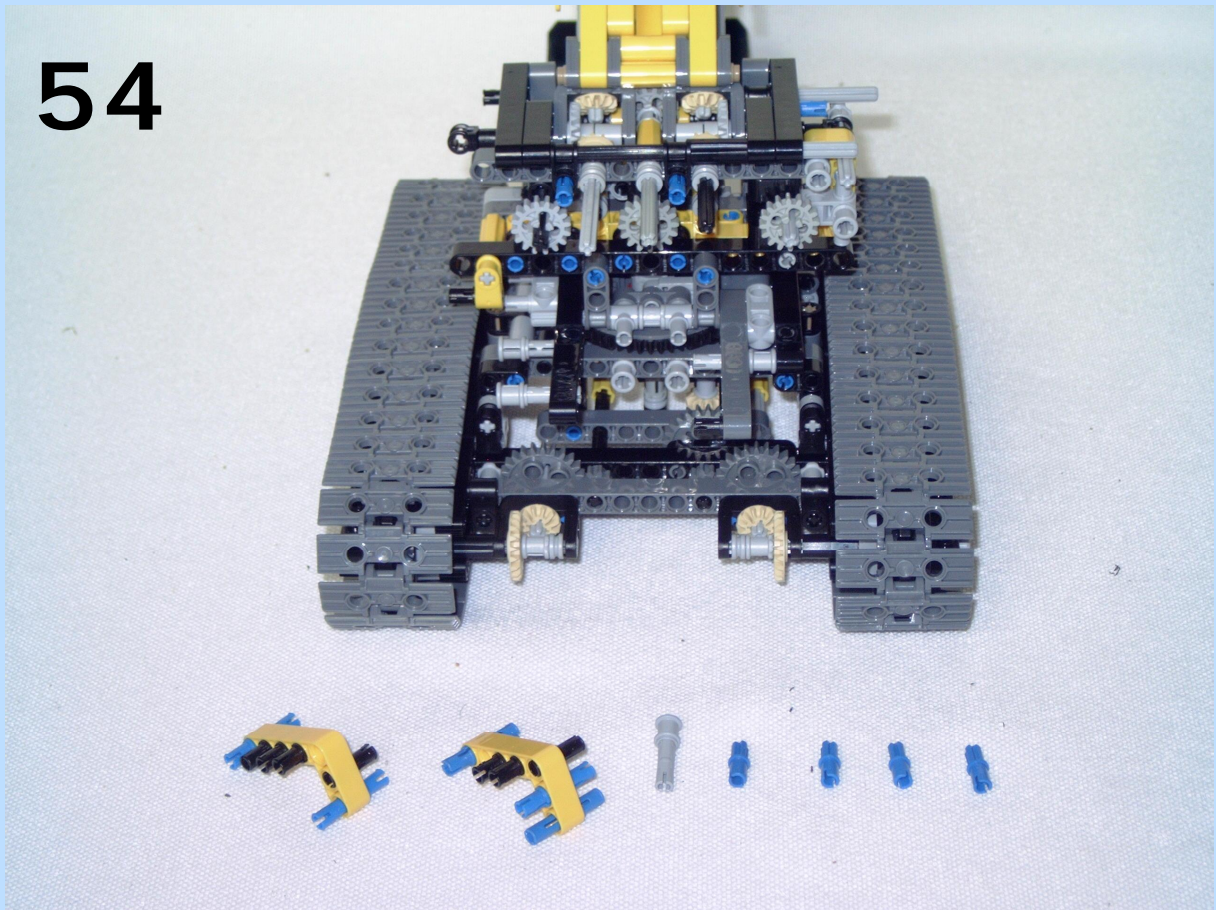

55

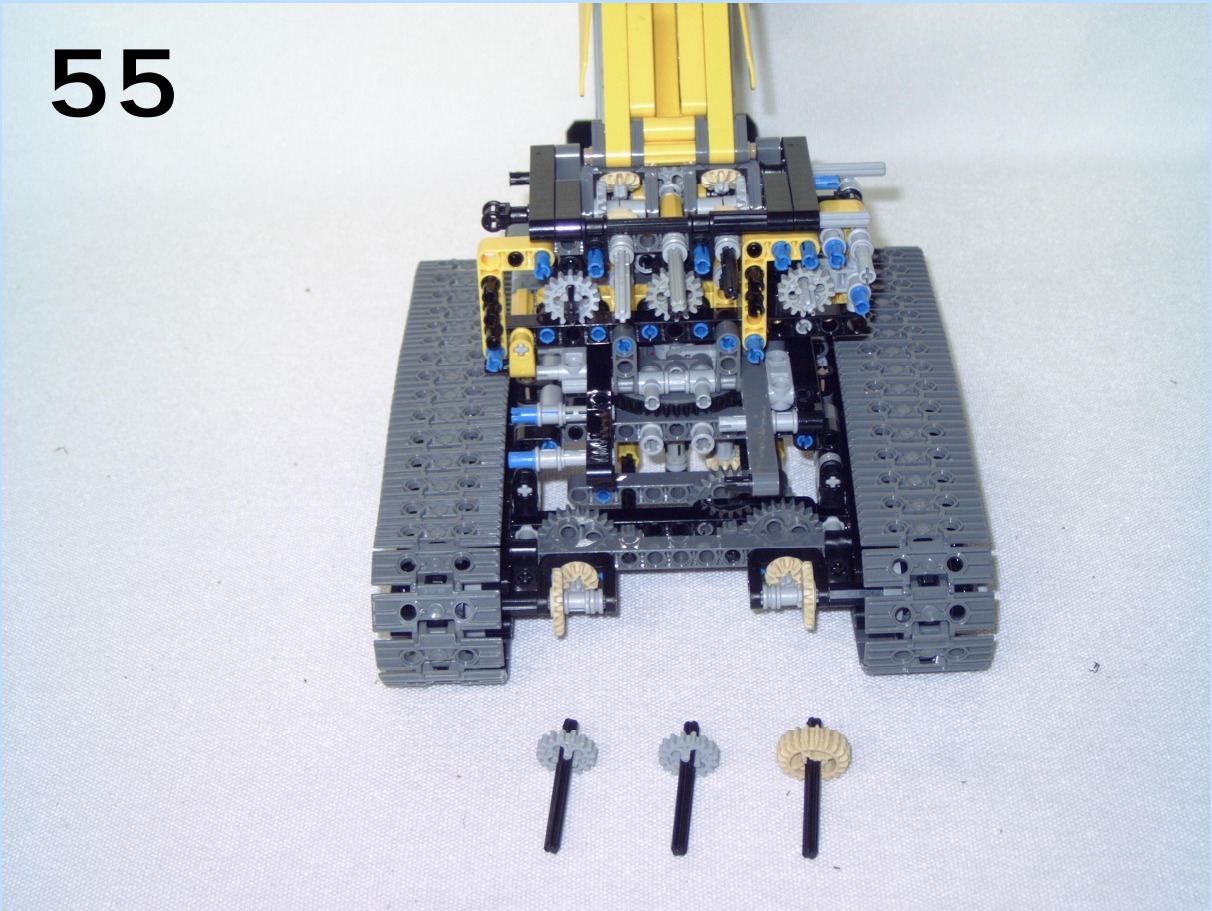

56

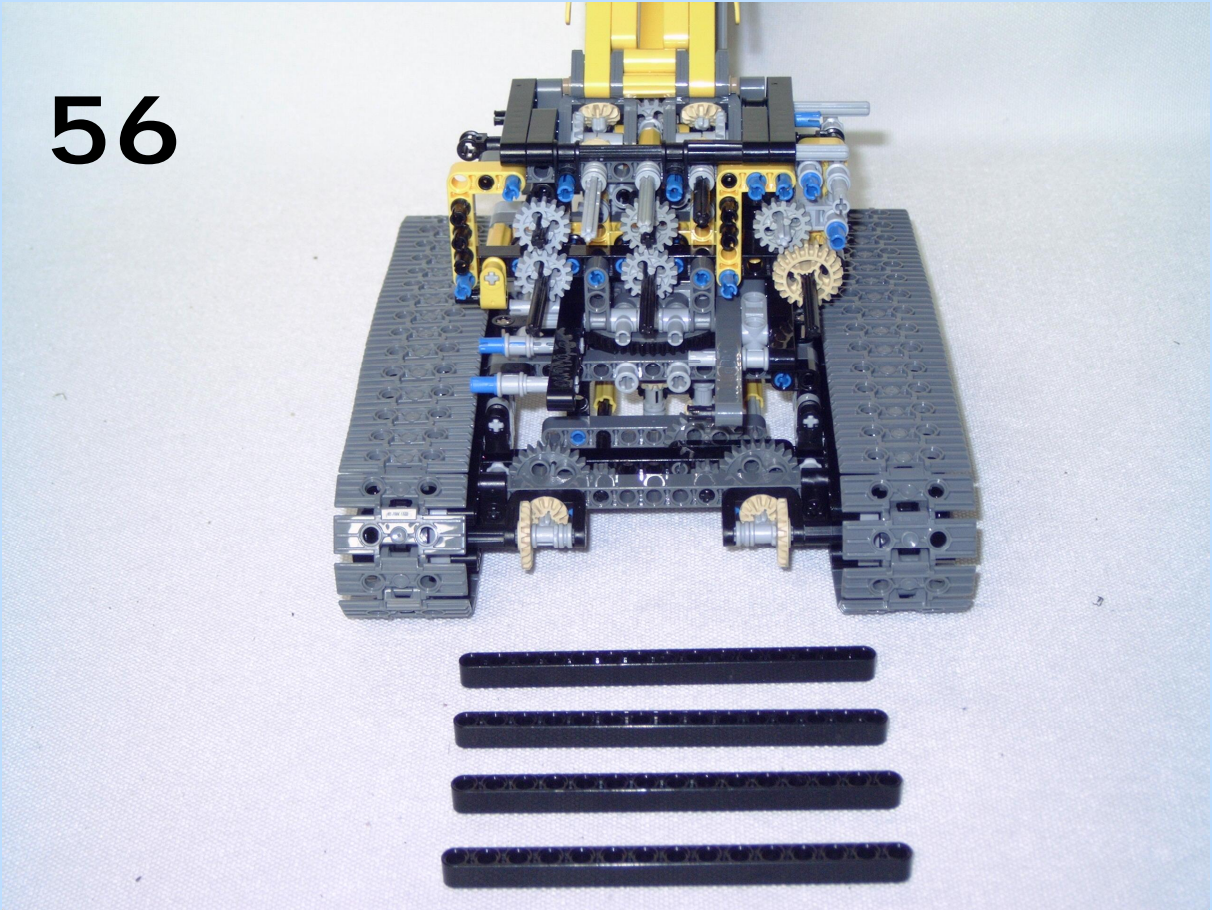

57

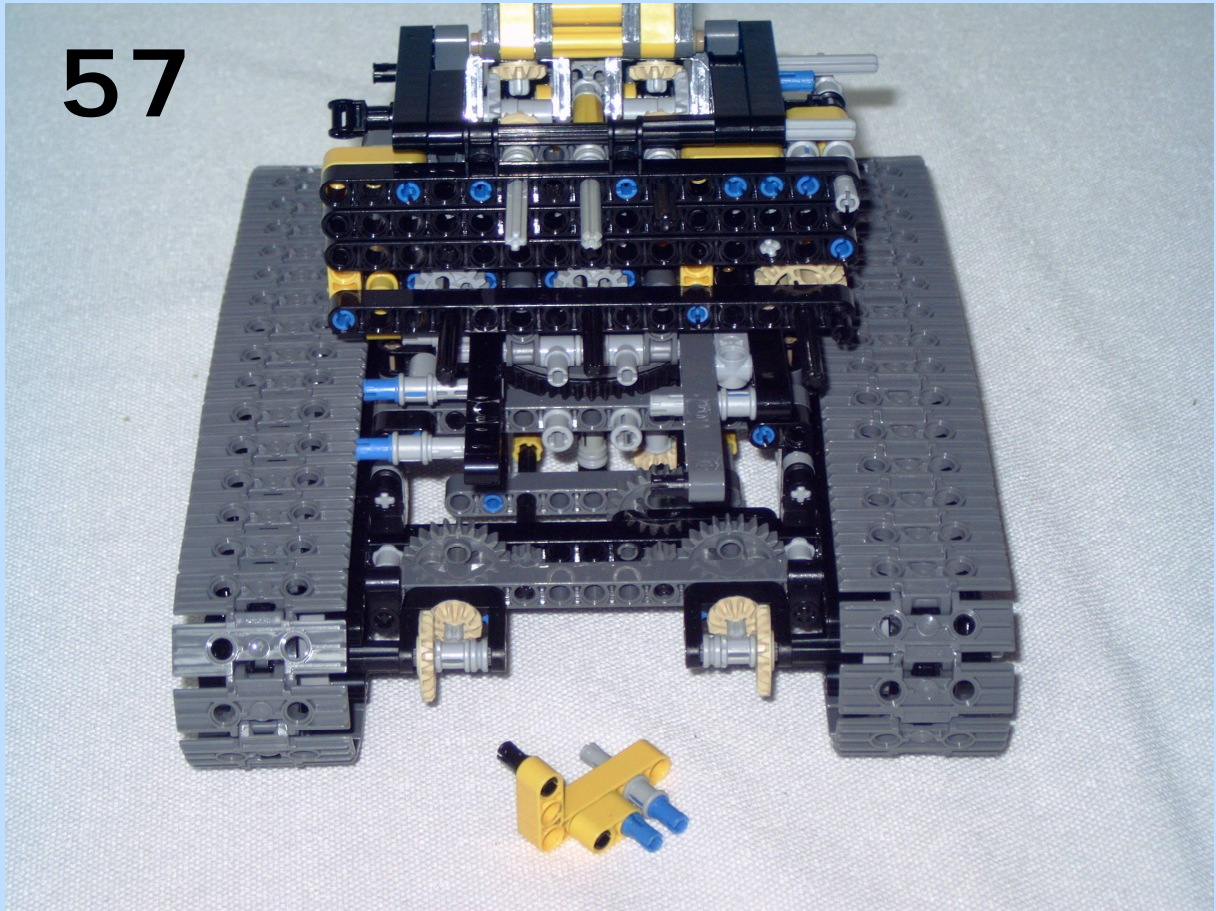

58

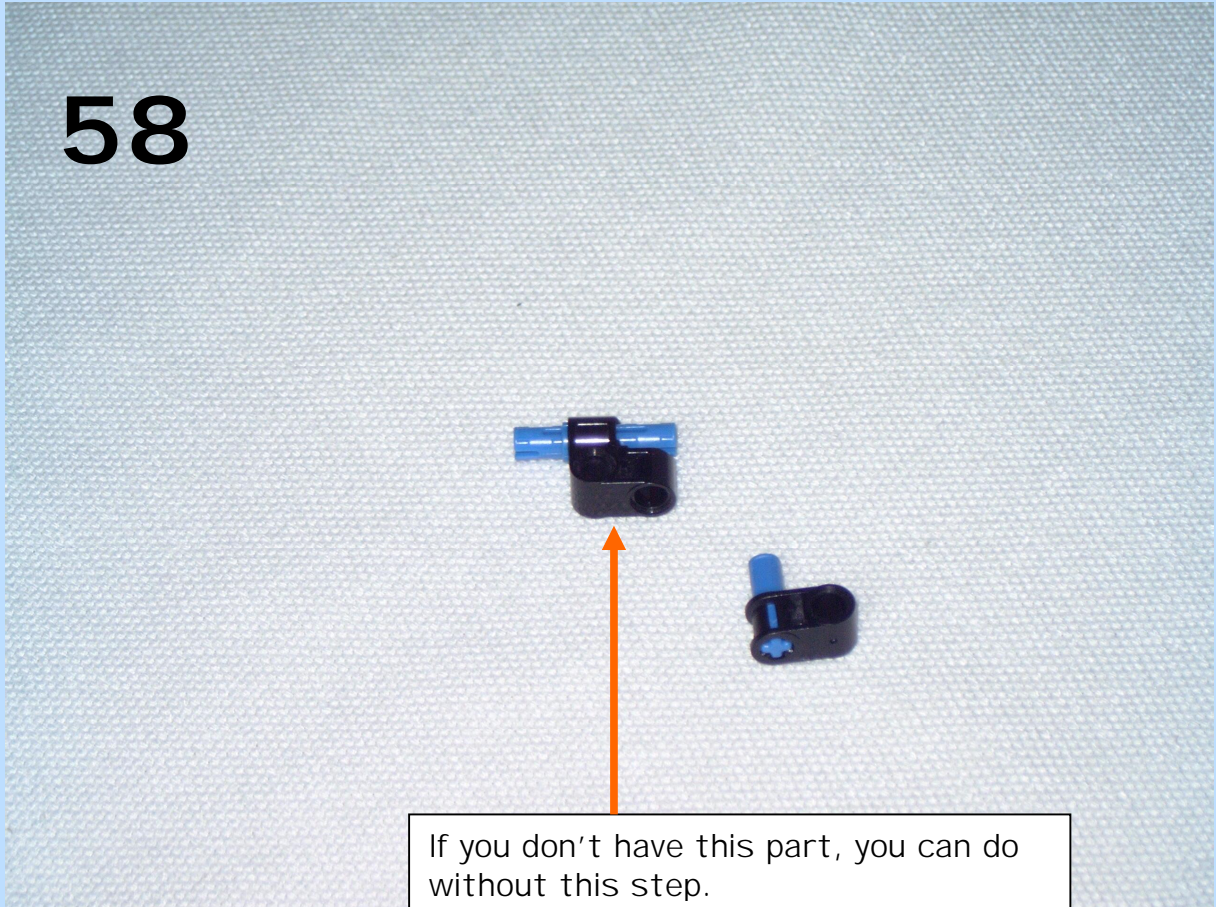

If you don't have this part, you can do without this step.

59

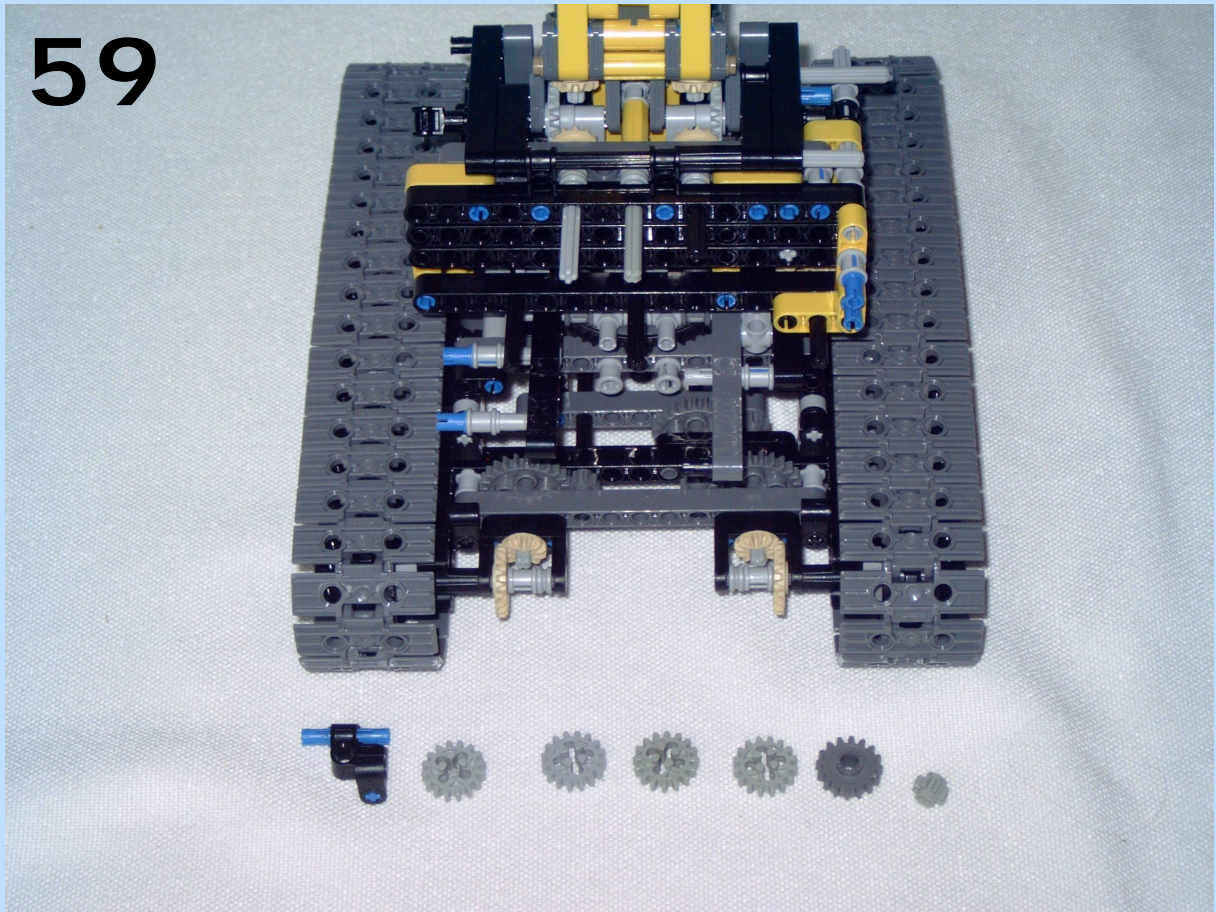

60

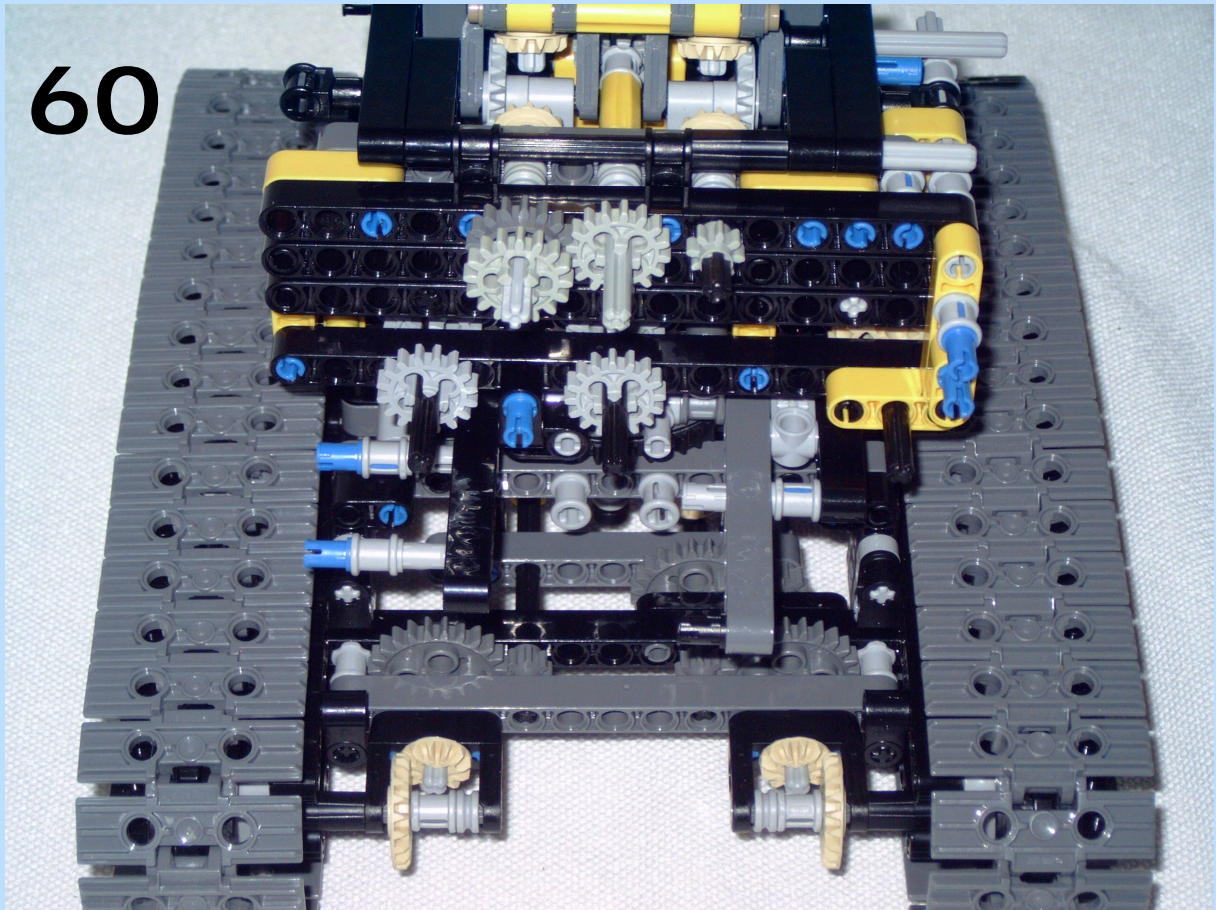

61

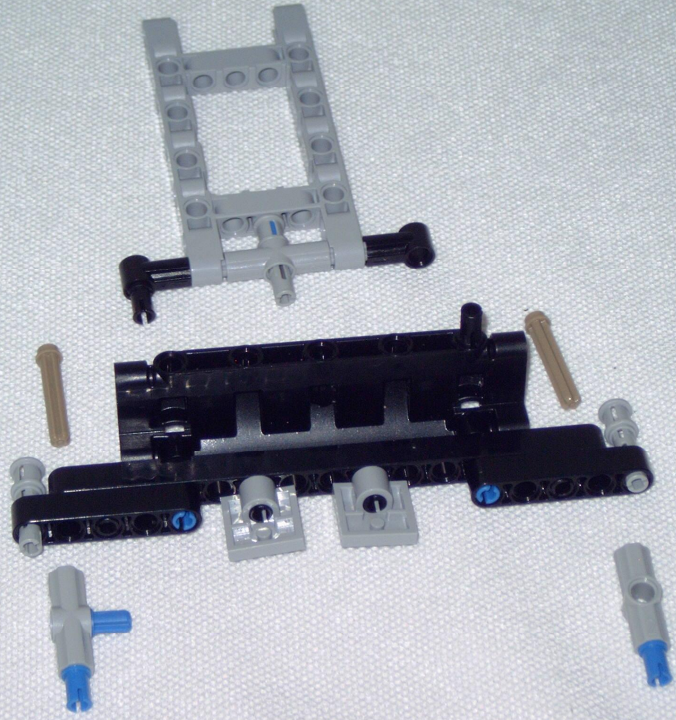

See step 1 - 8
(Book 1, page 53 - 55)

62

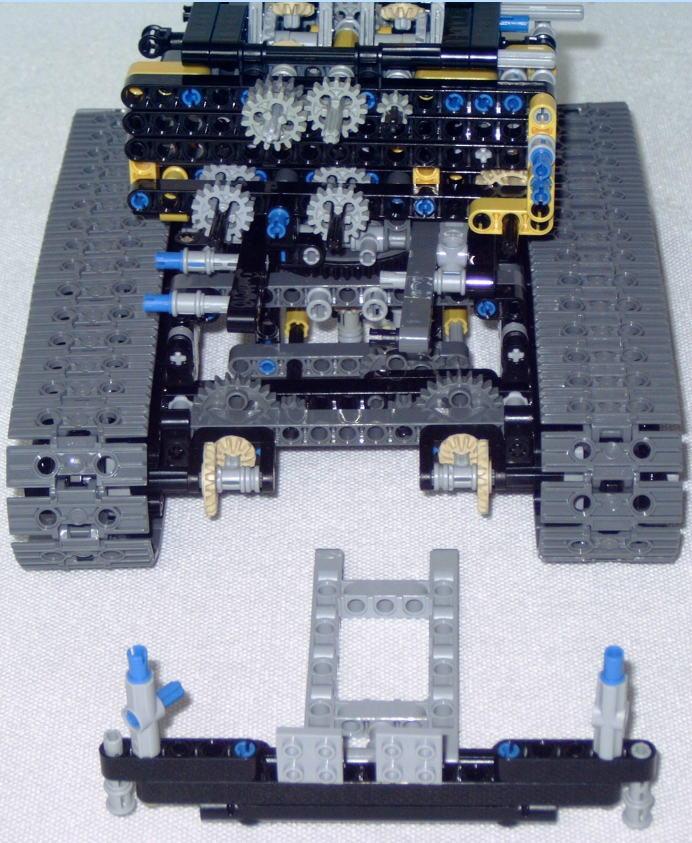

63

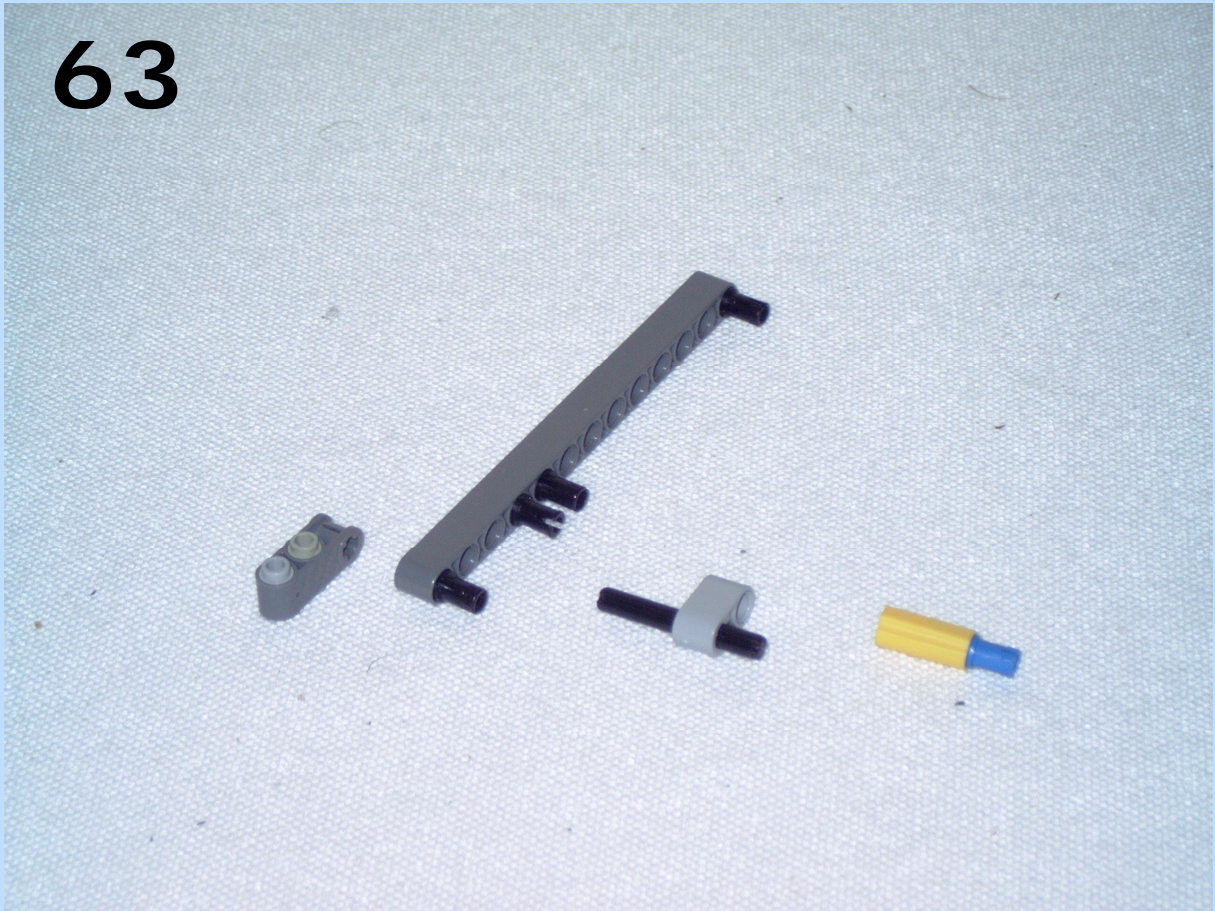

64

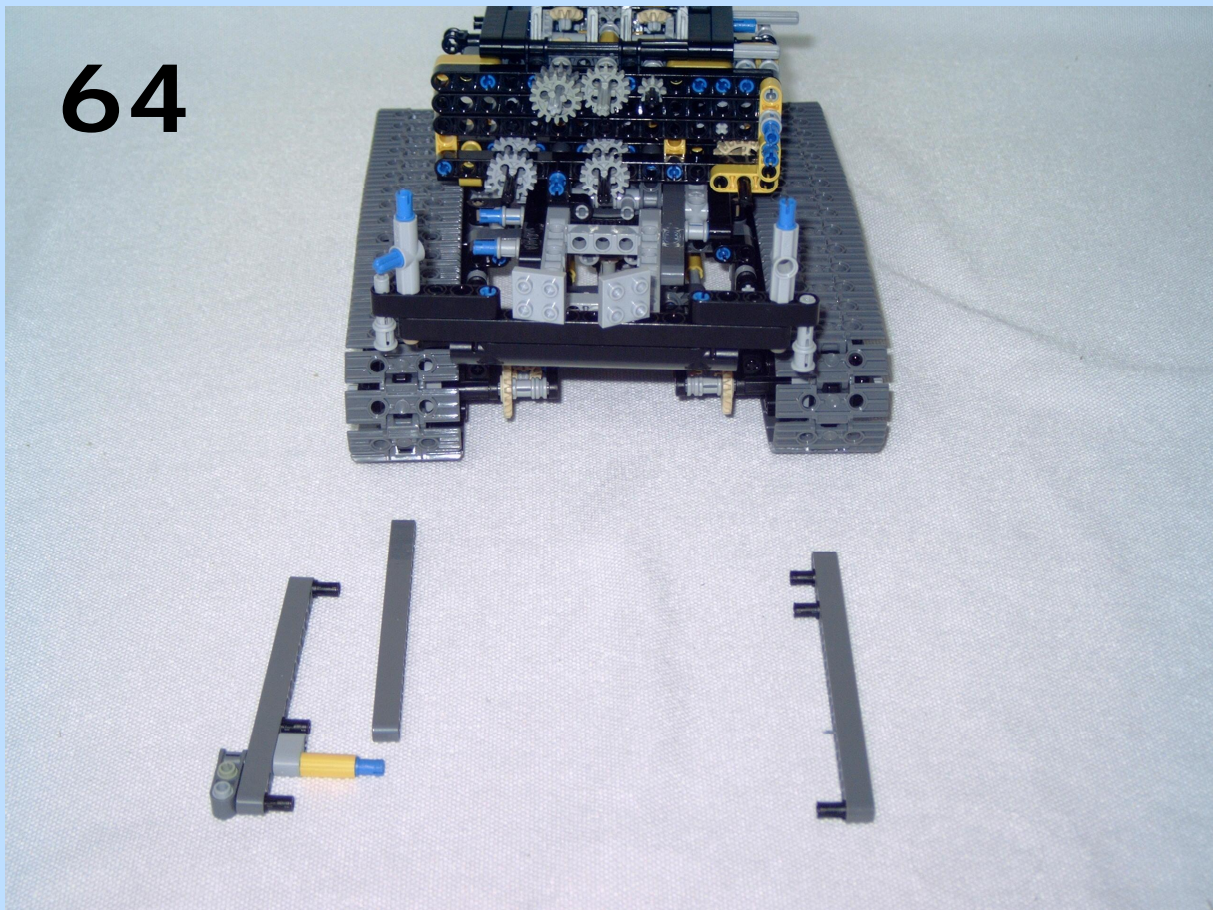

65

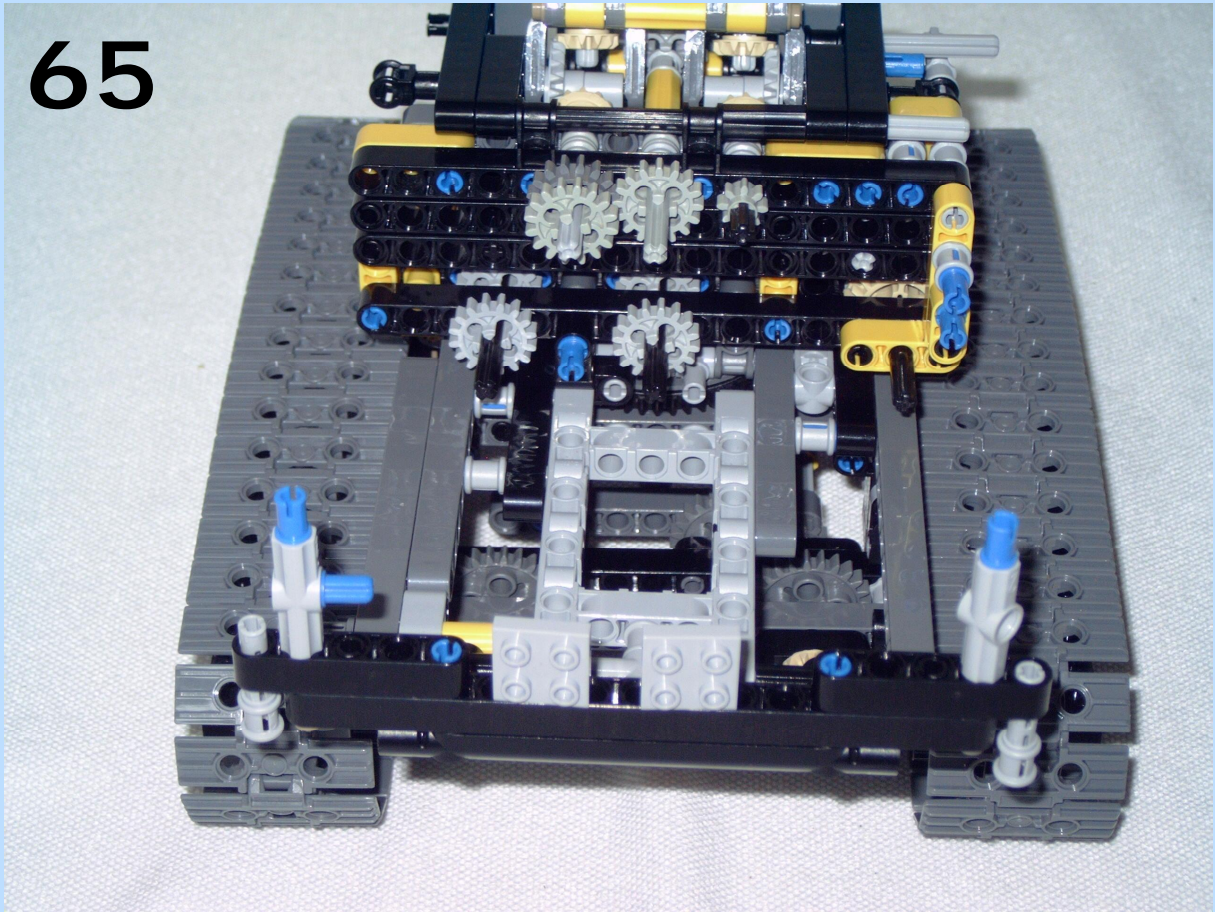

66

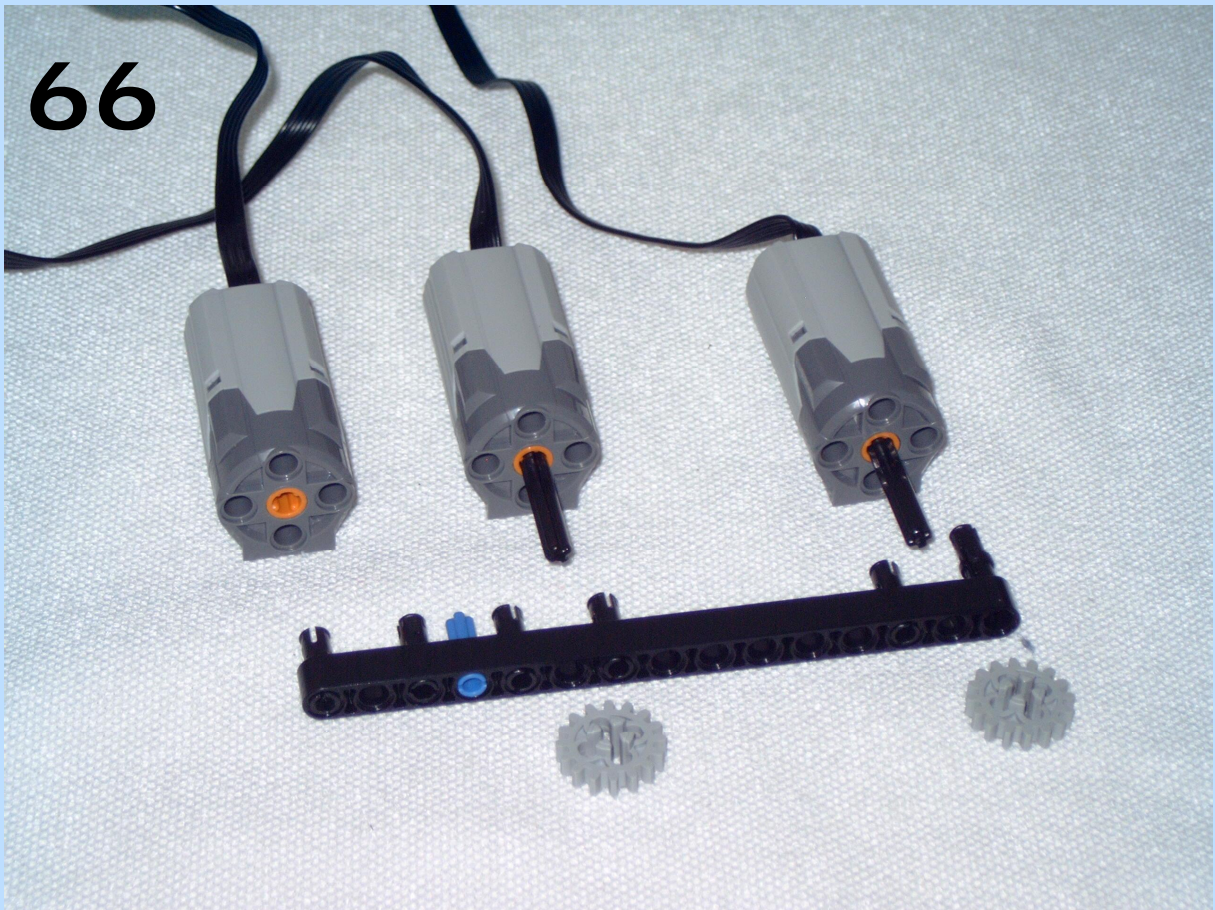

67

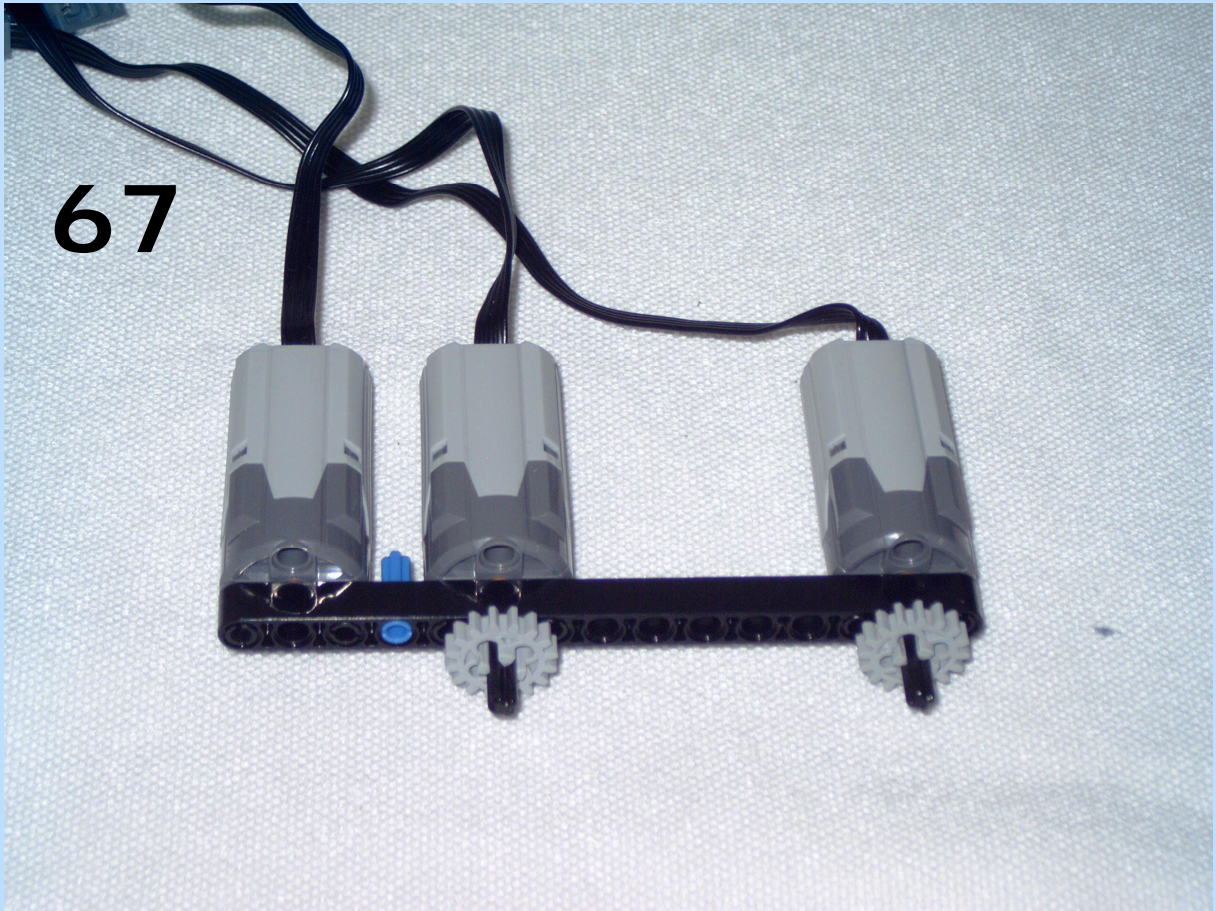

68

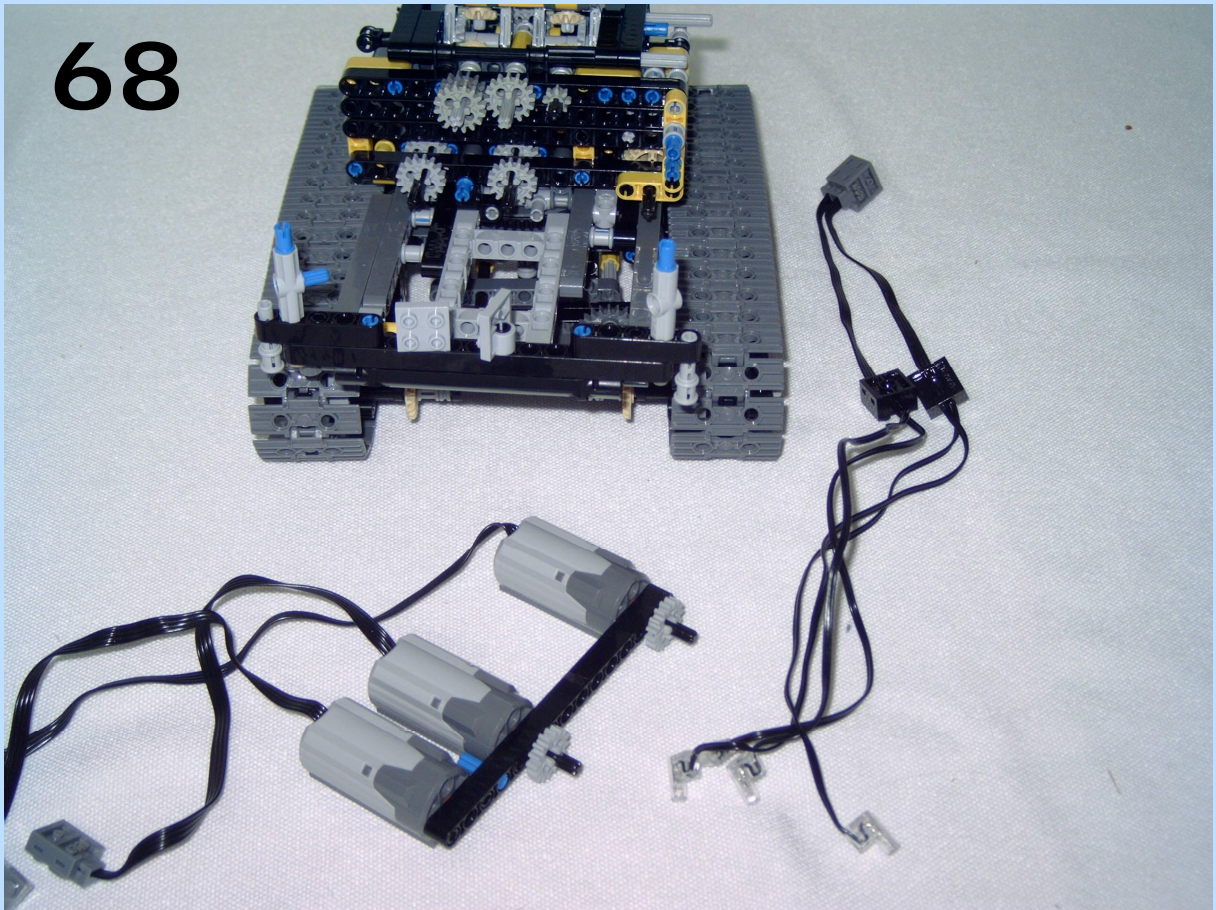

69

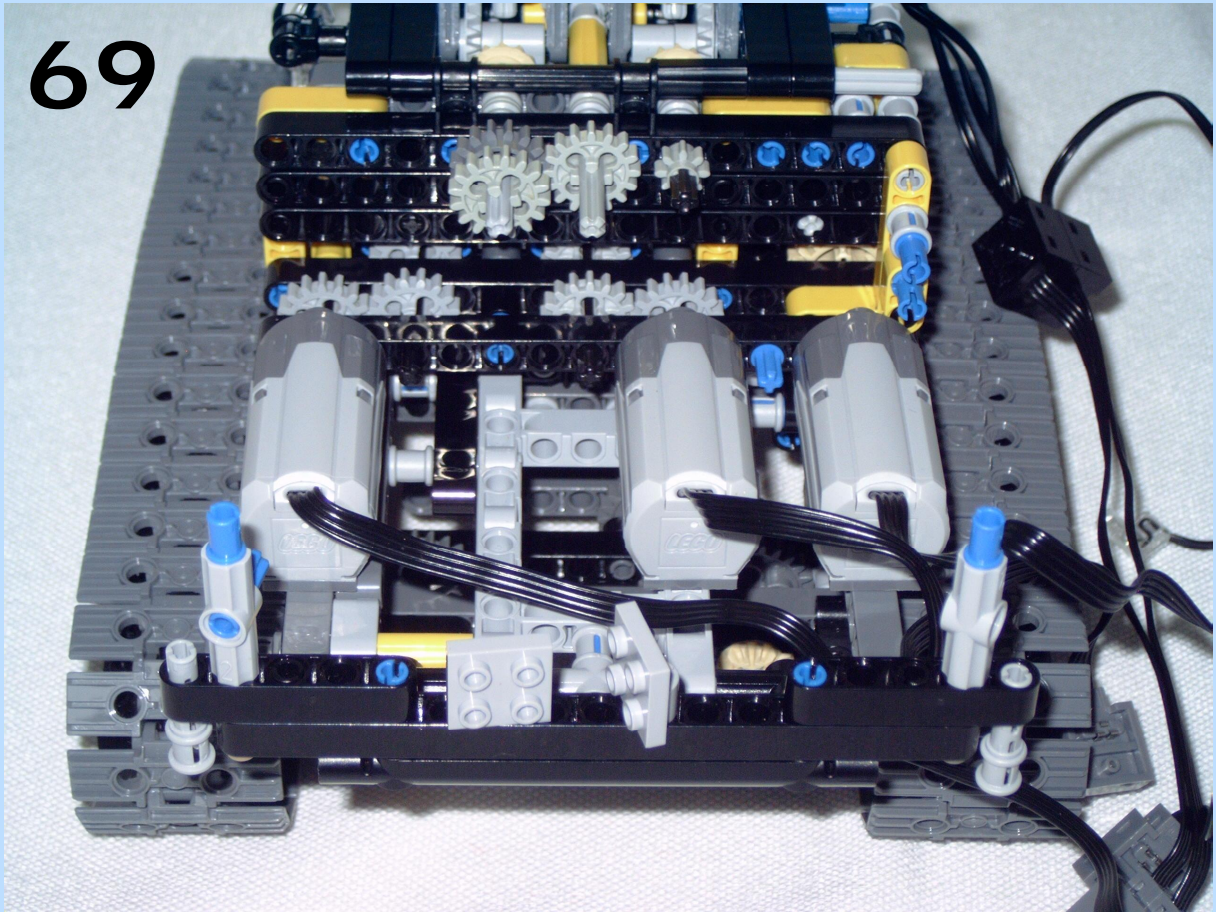

70

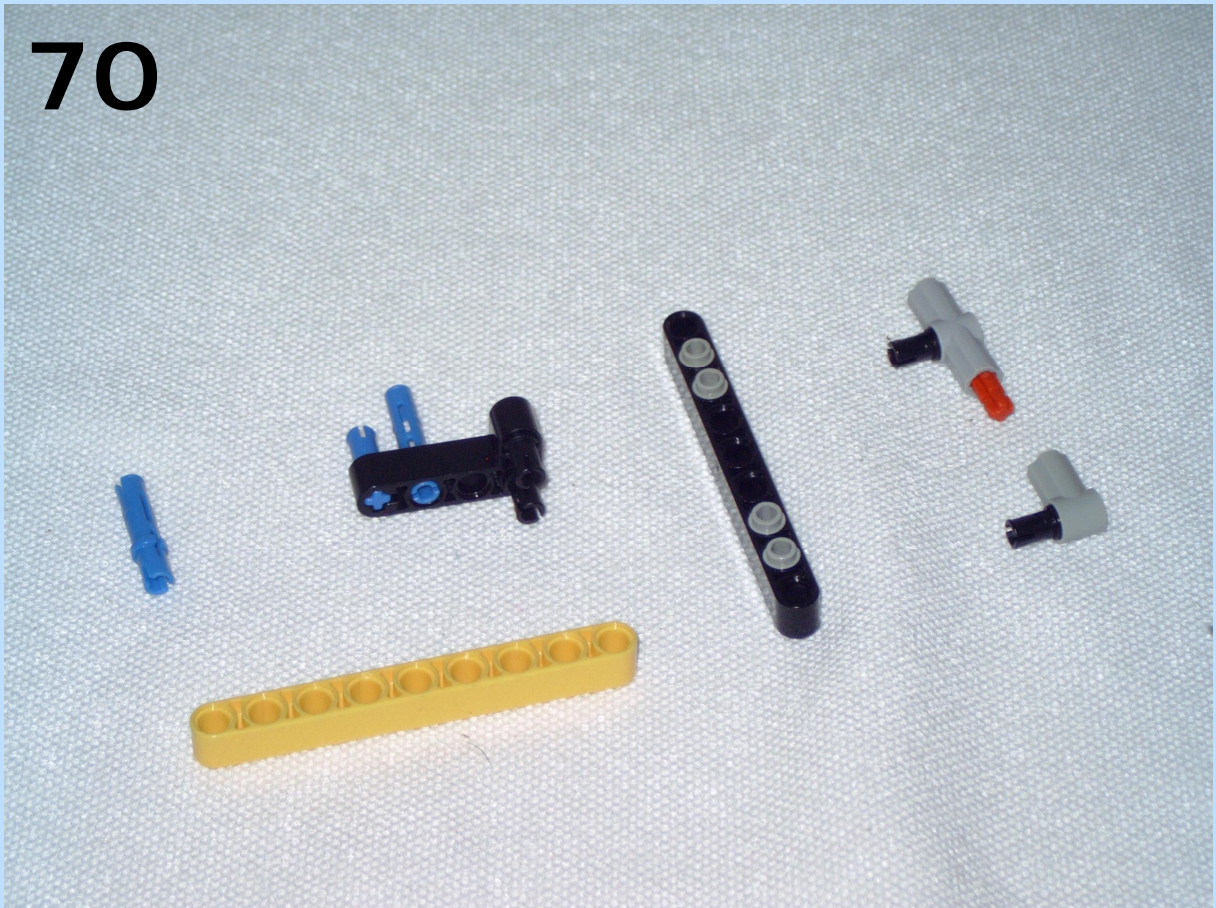

71

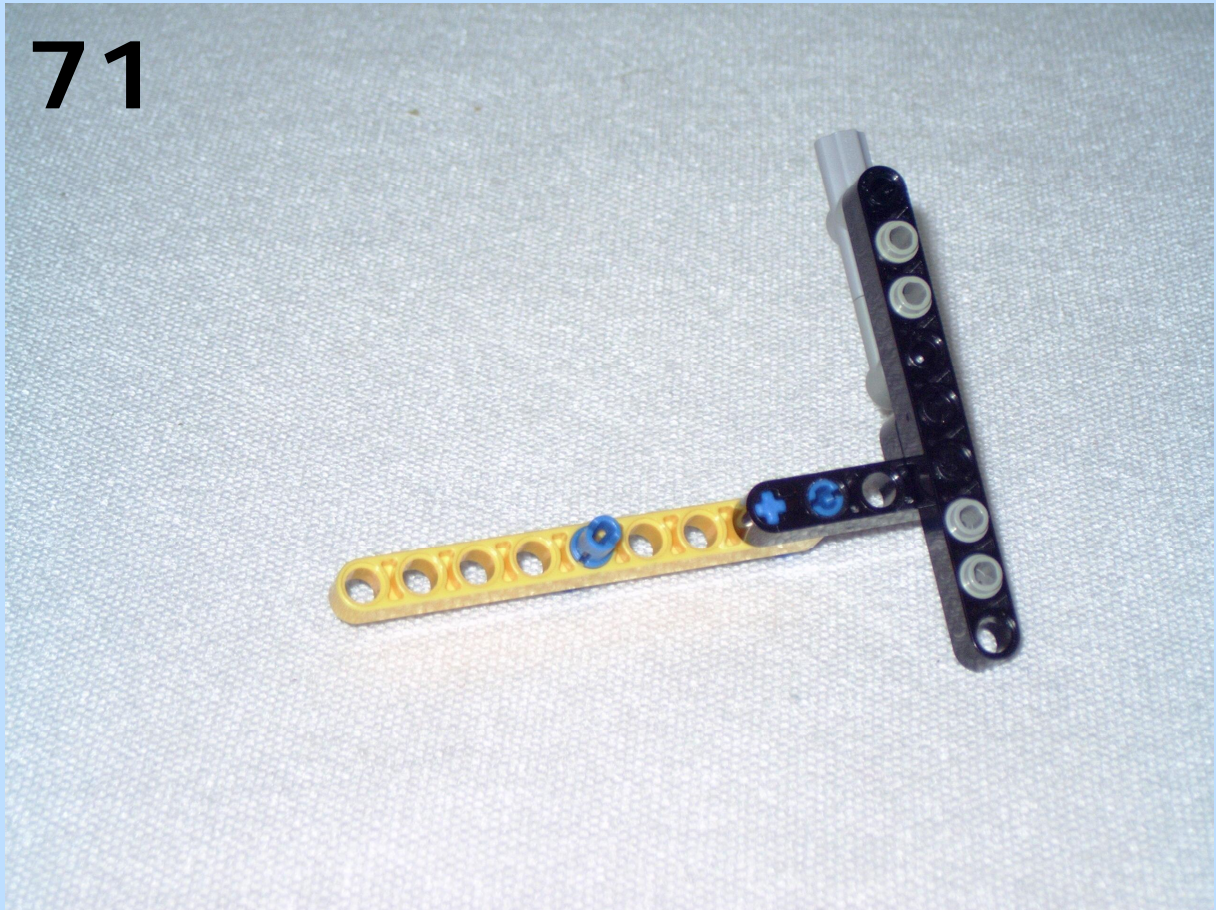

72

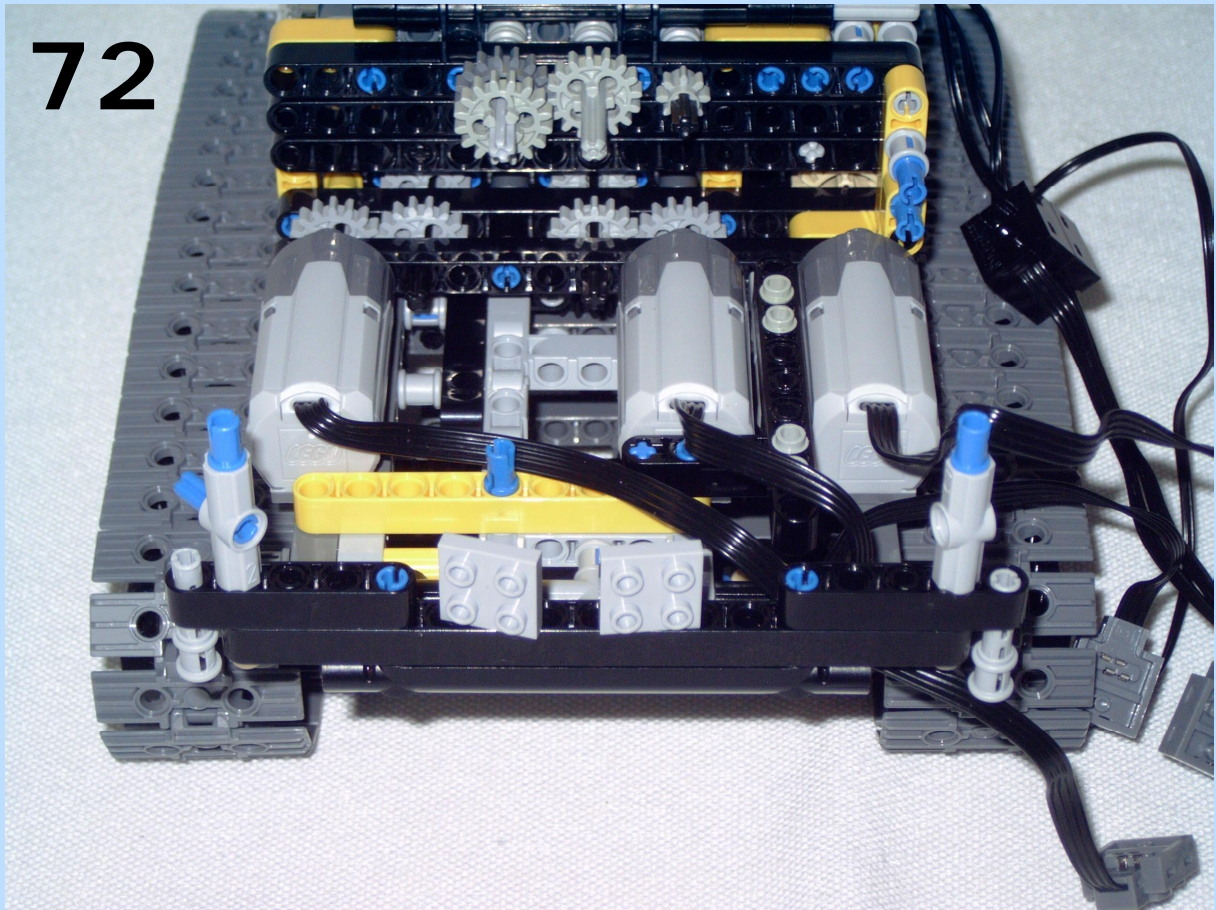

73

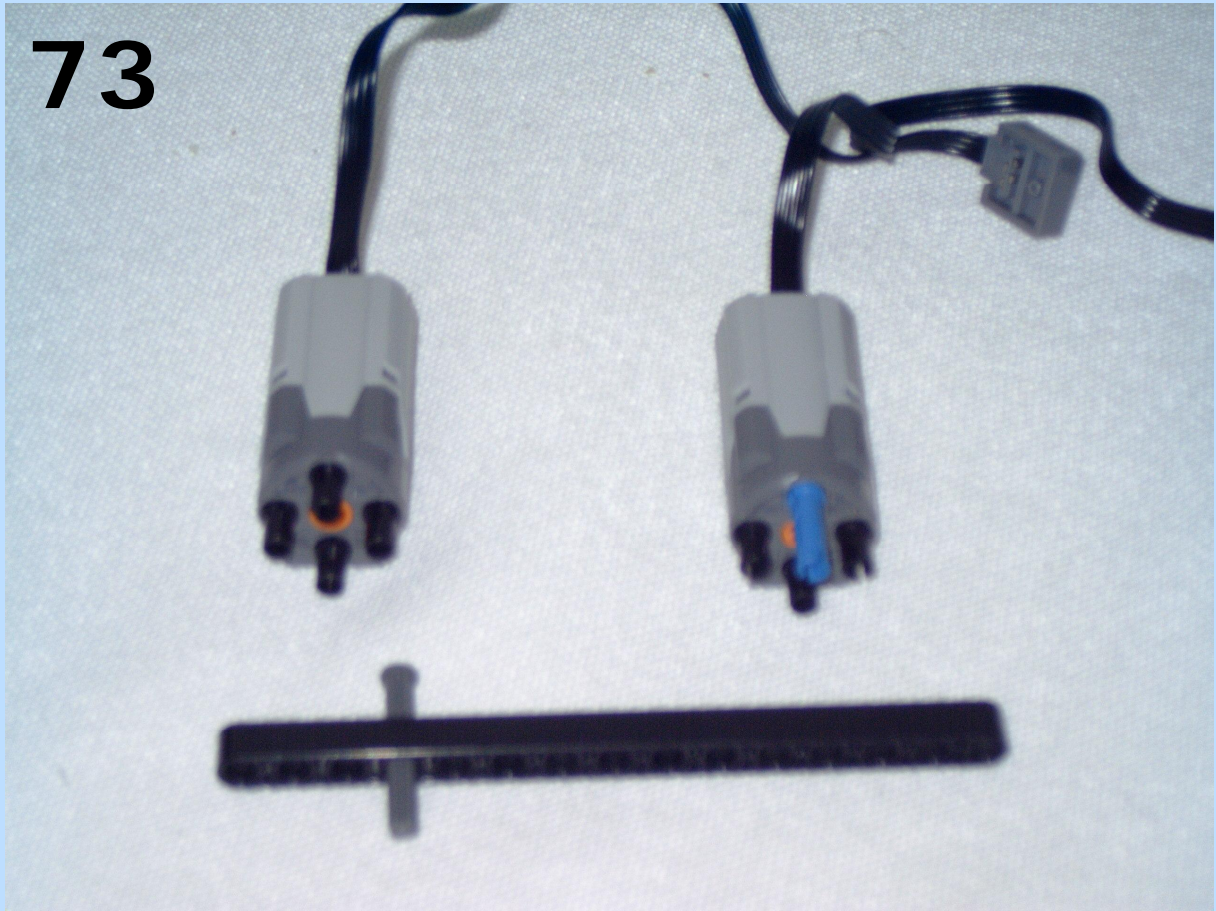

74

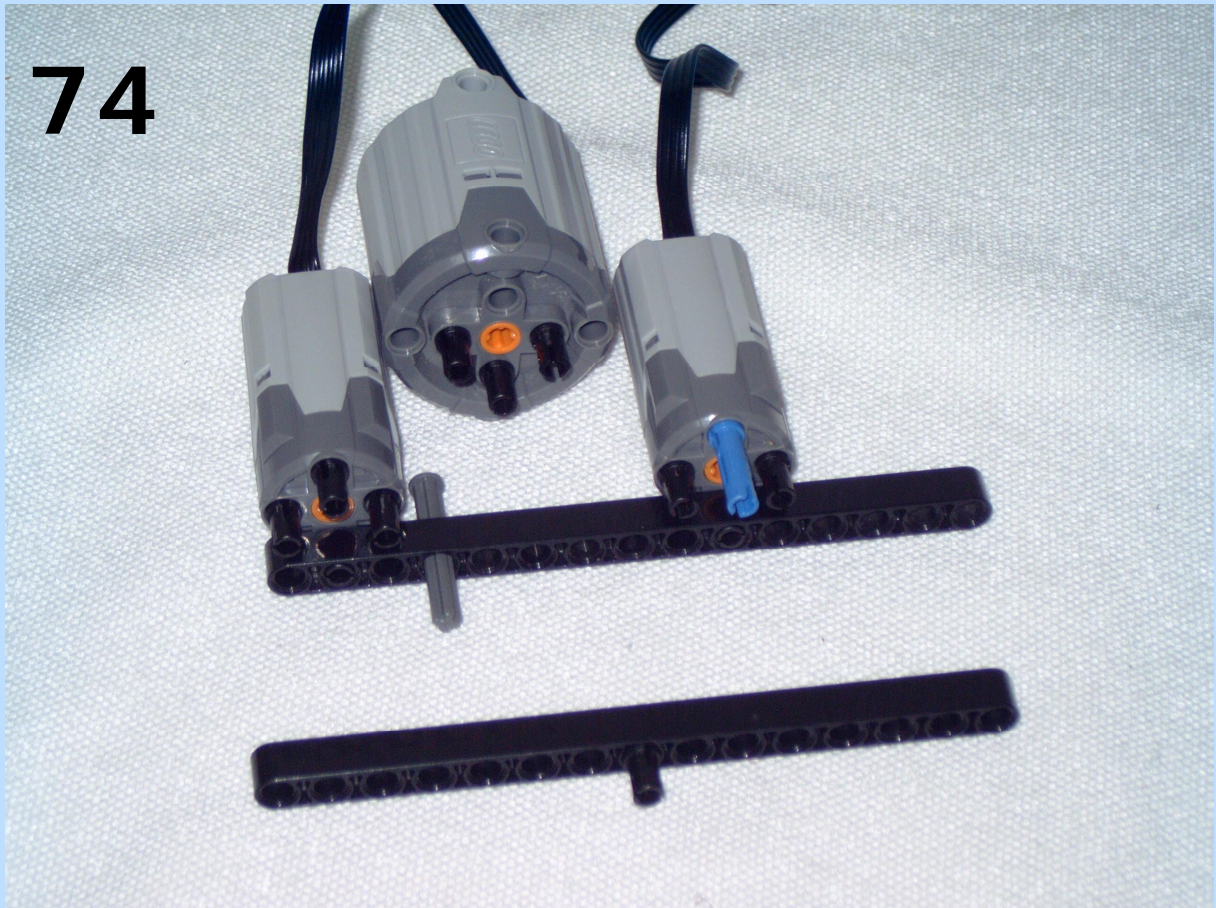

75

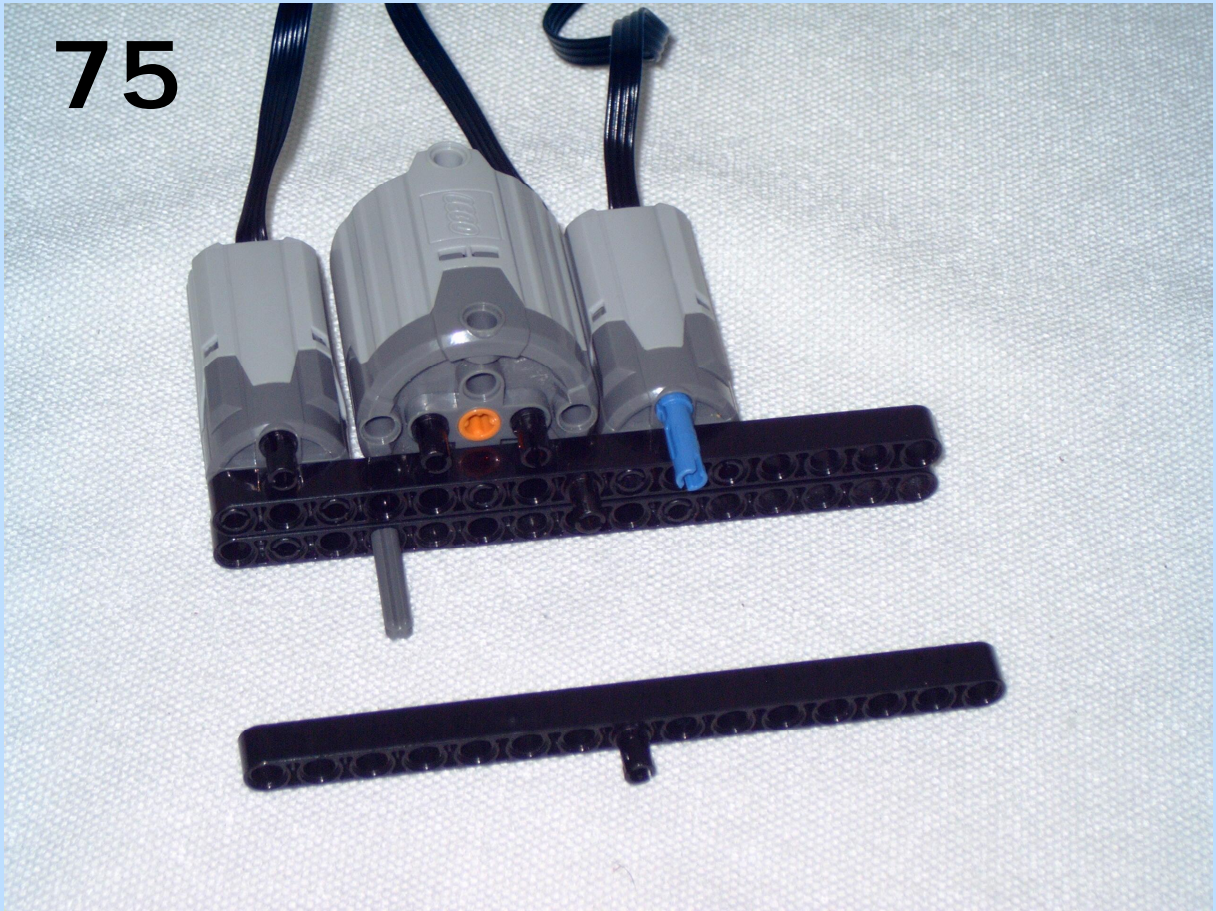

76

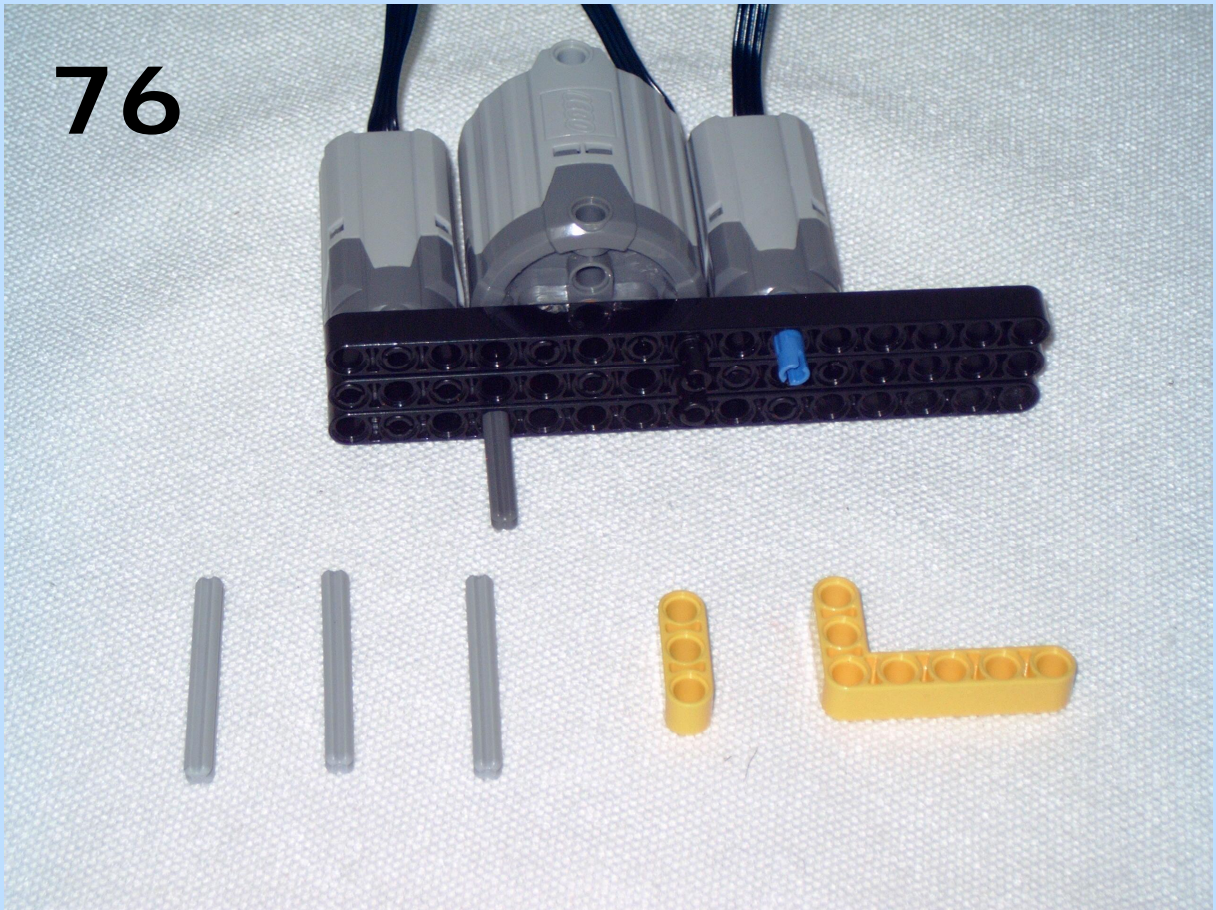

77

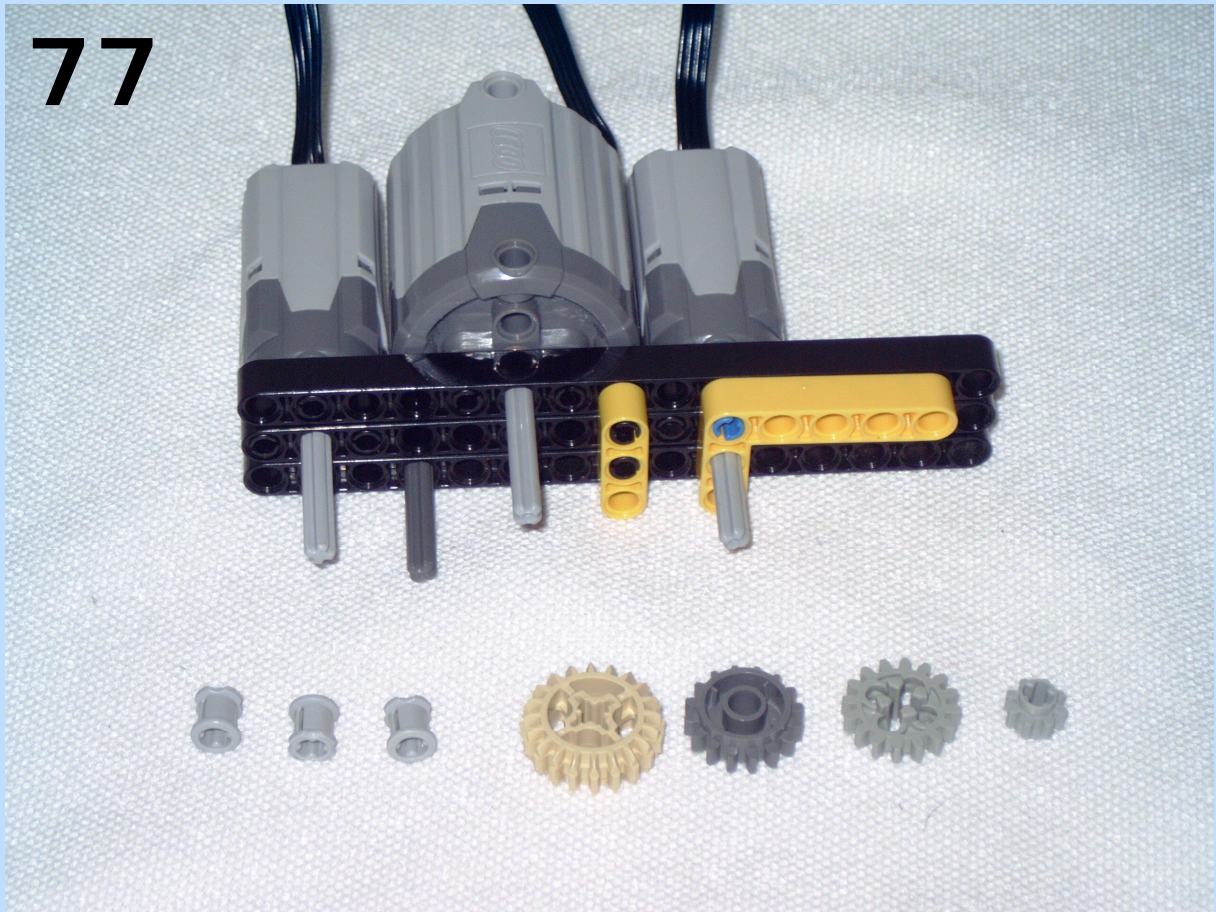

78



79

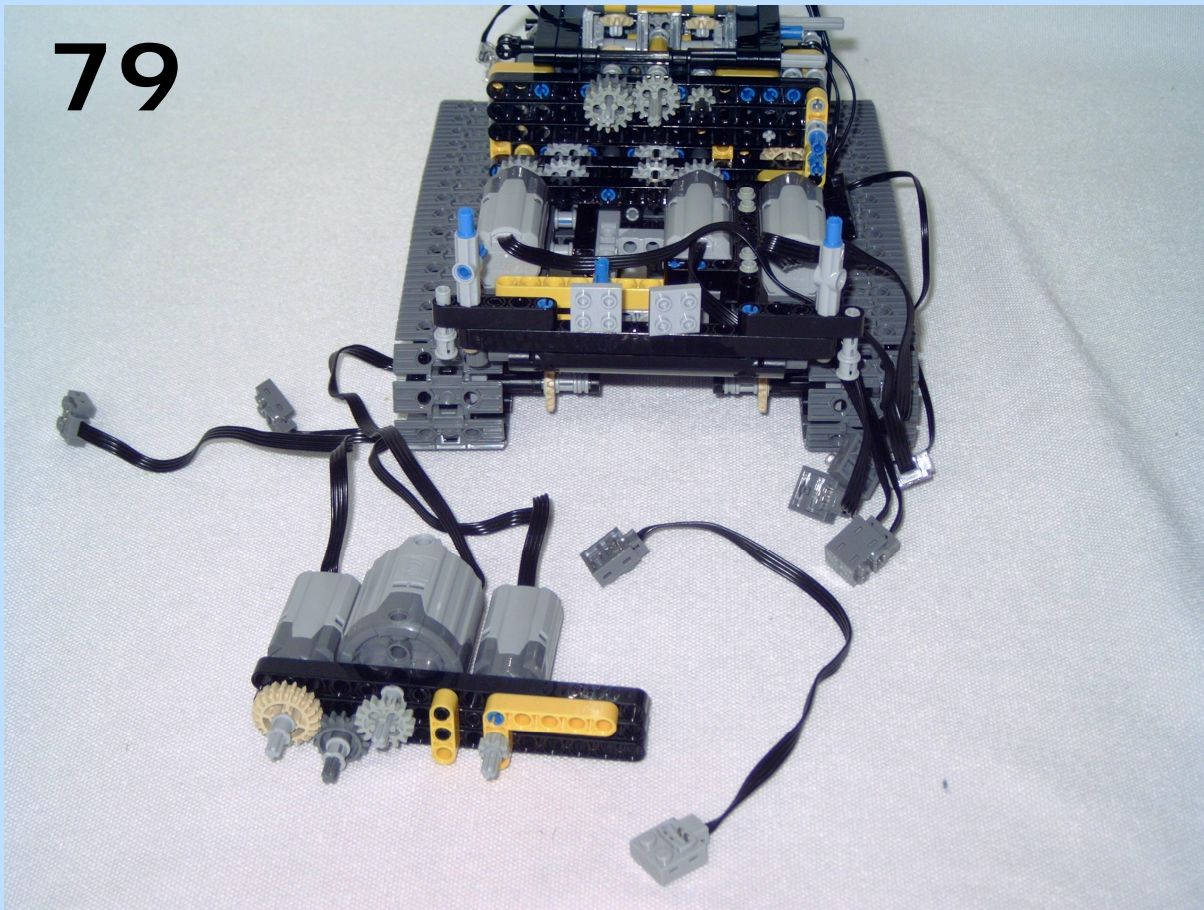

80

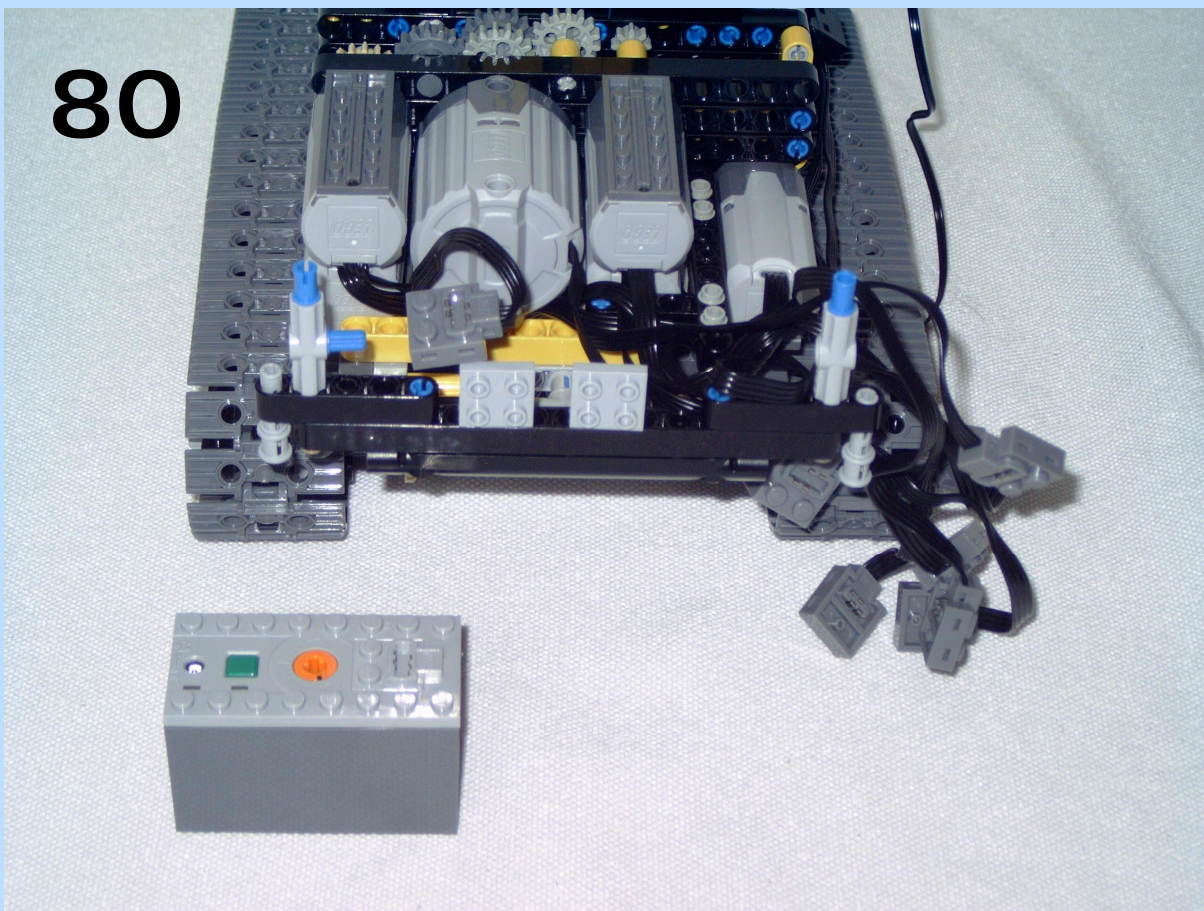

81

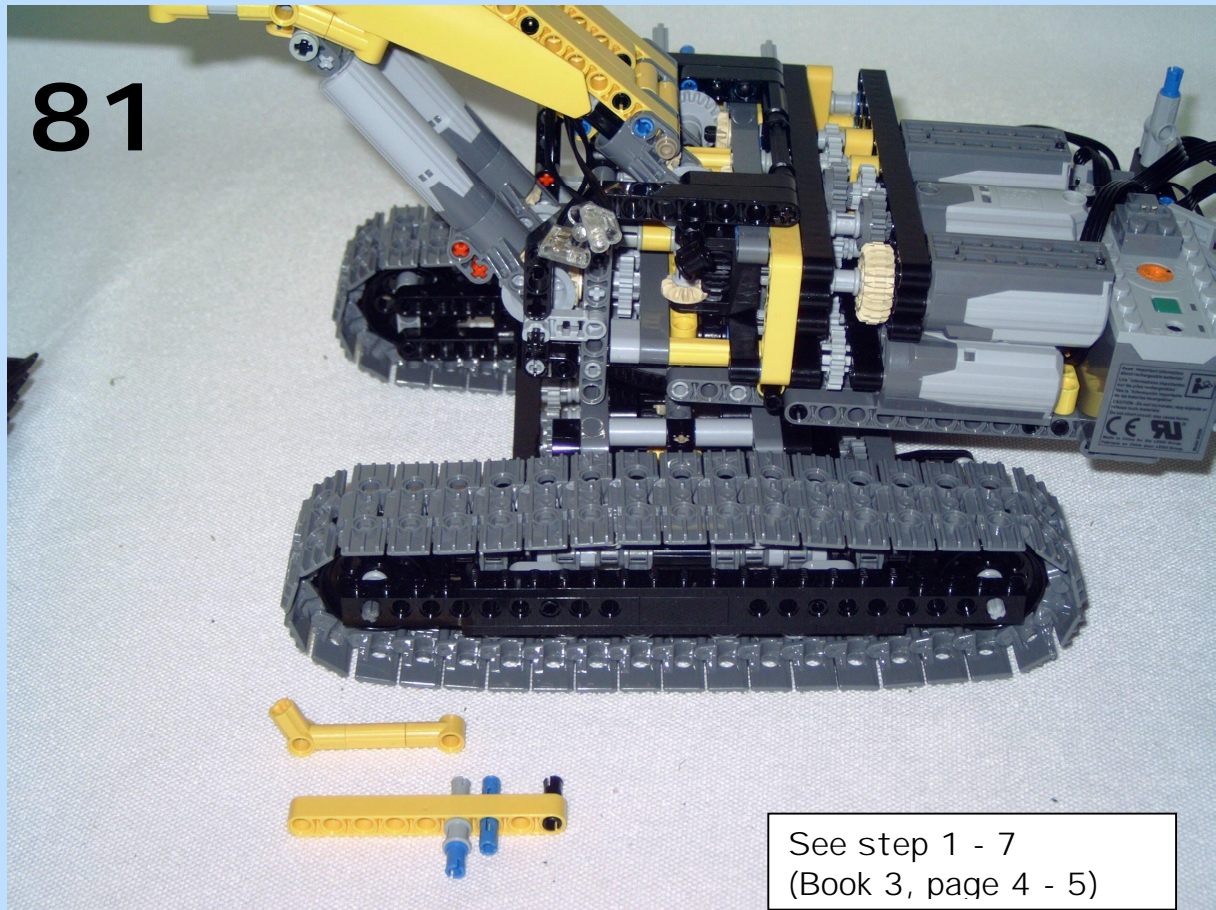

See step 1 - 7
(Book 3, page 4 - 5)

82

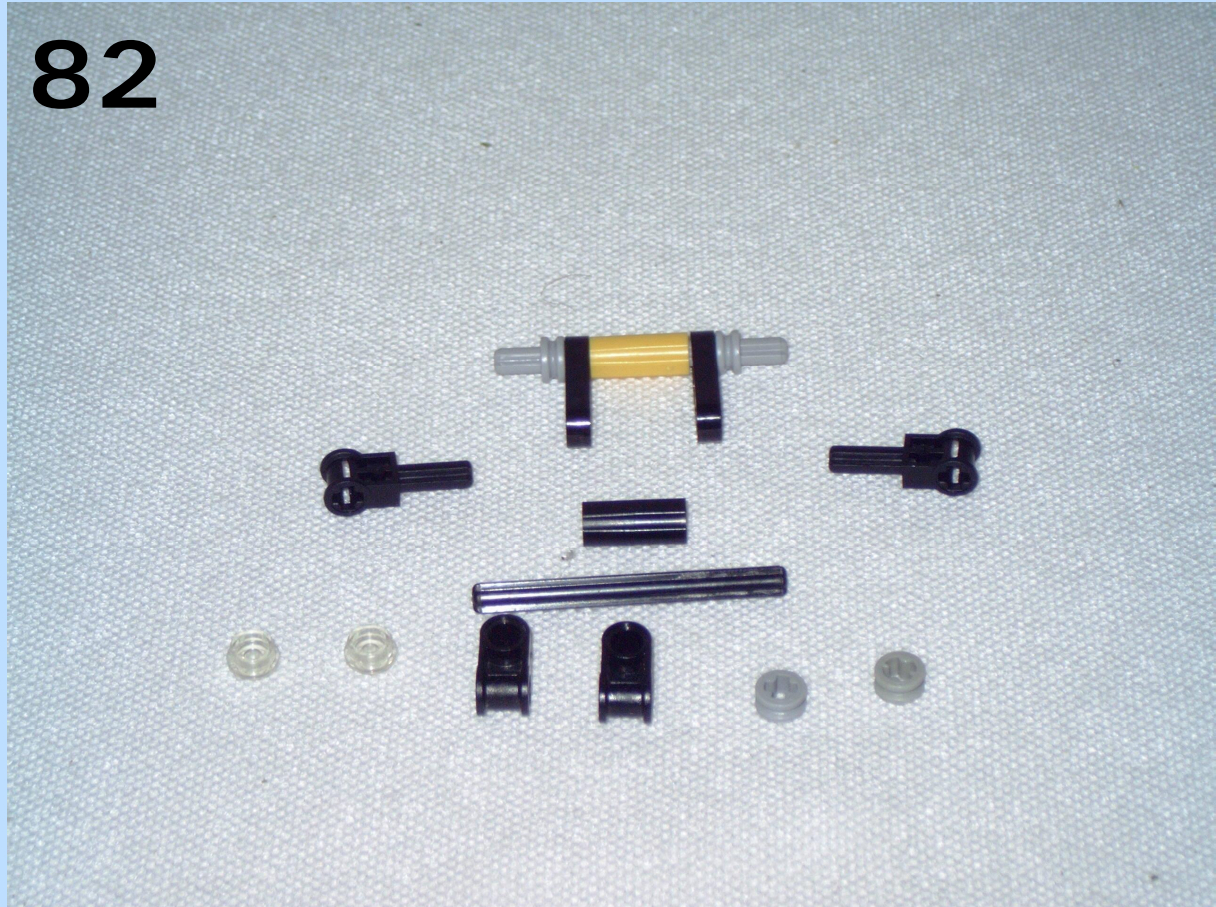

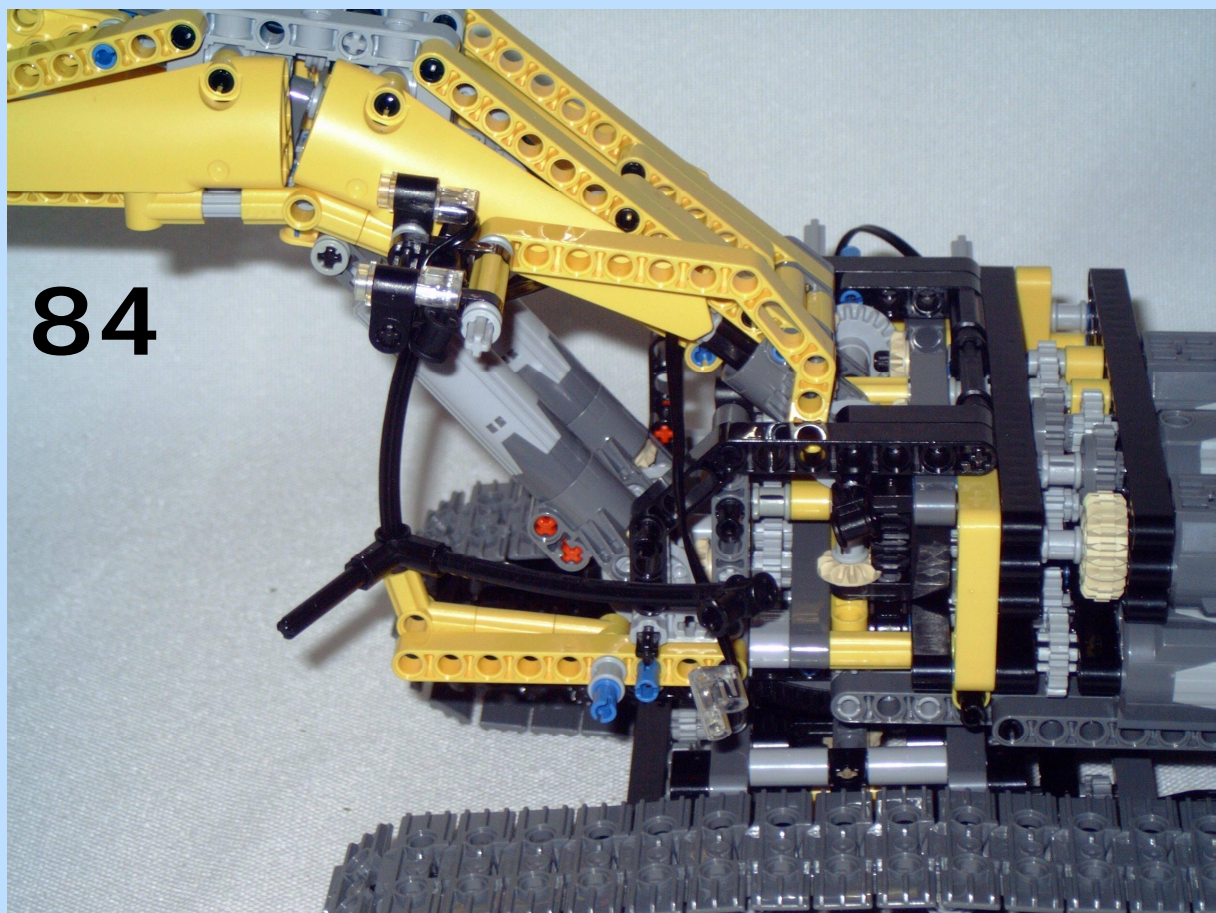
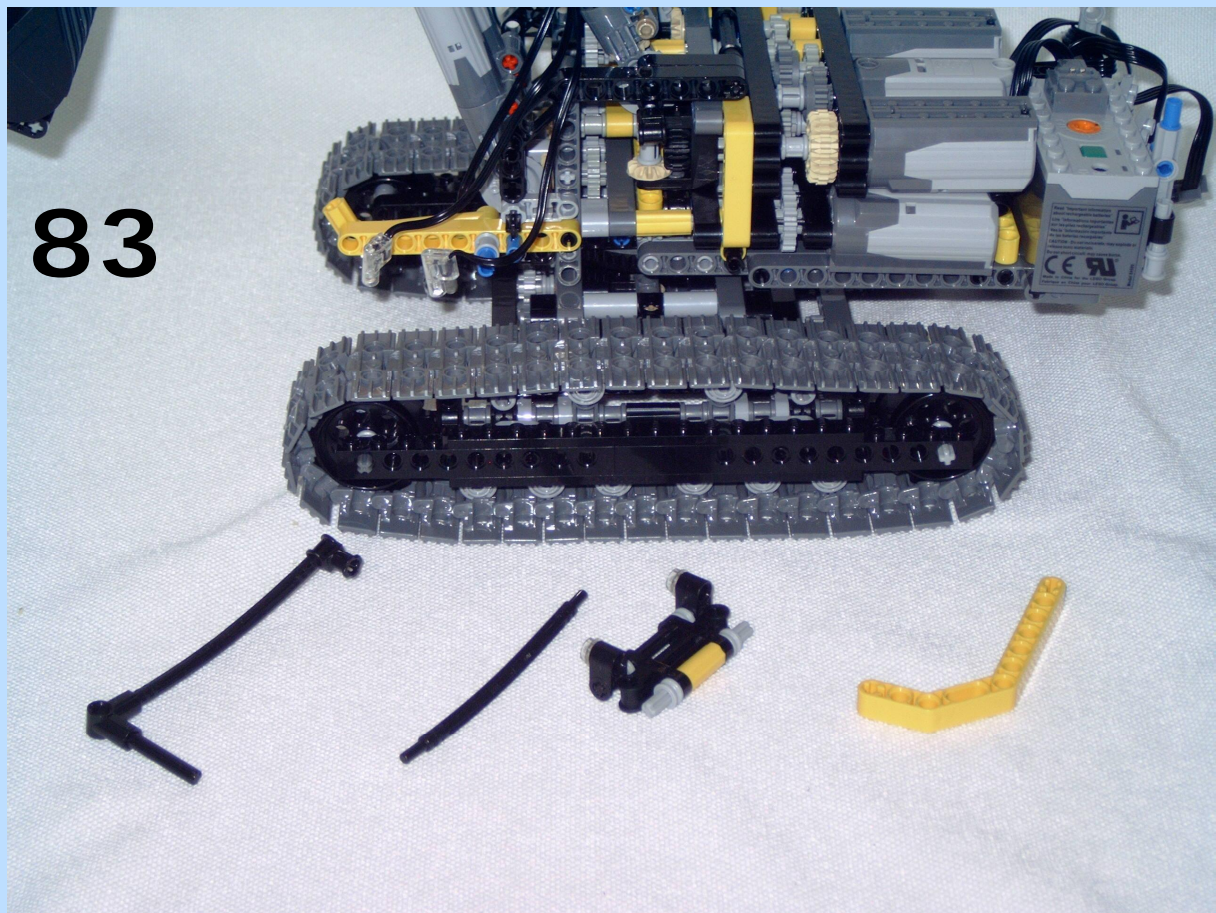

85

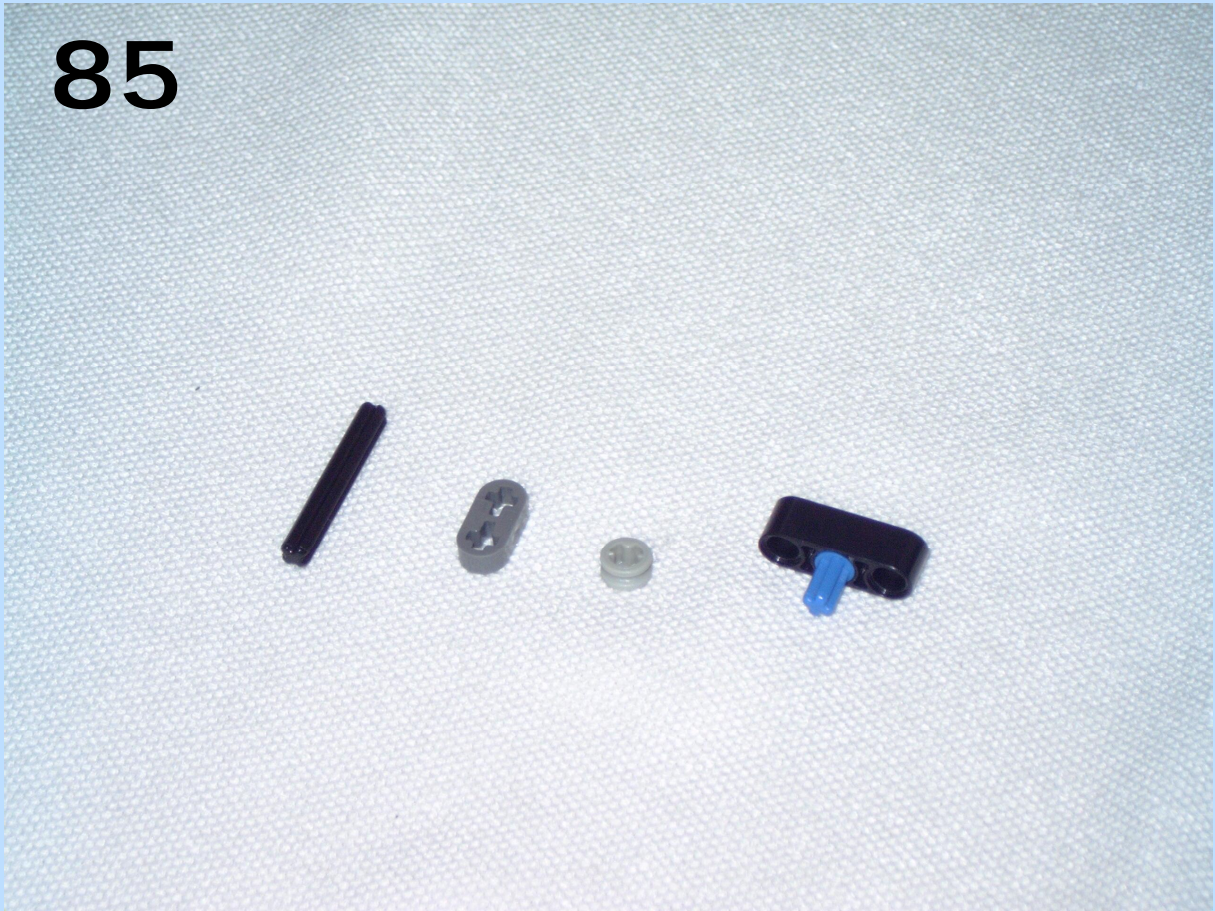

86

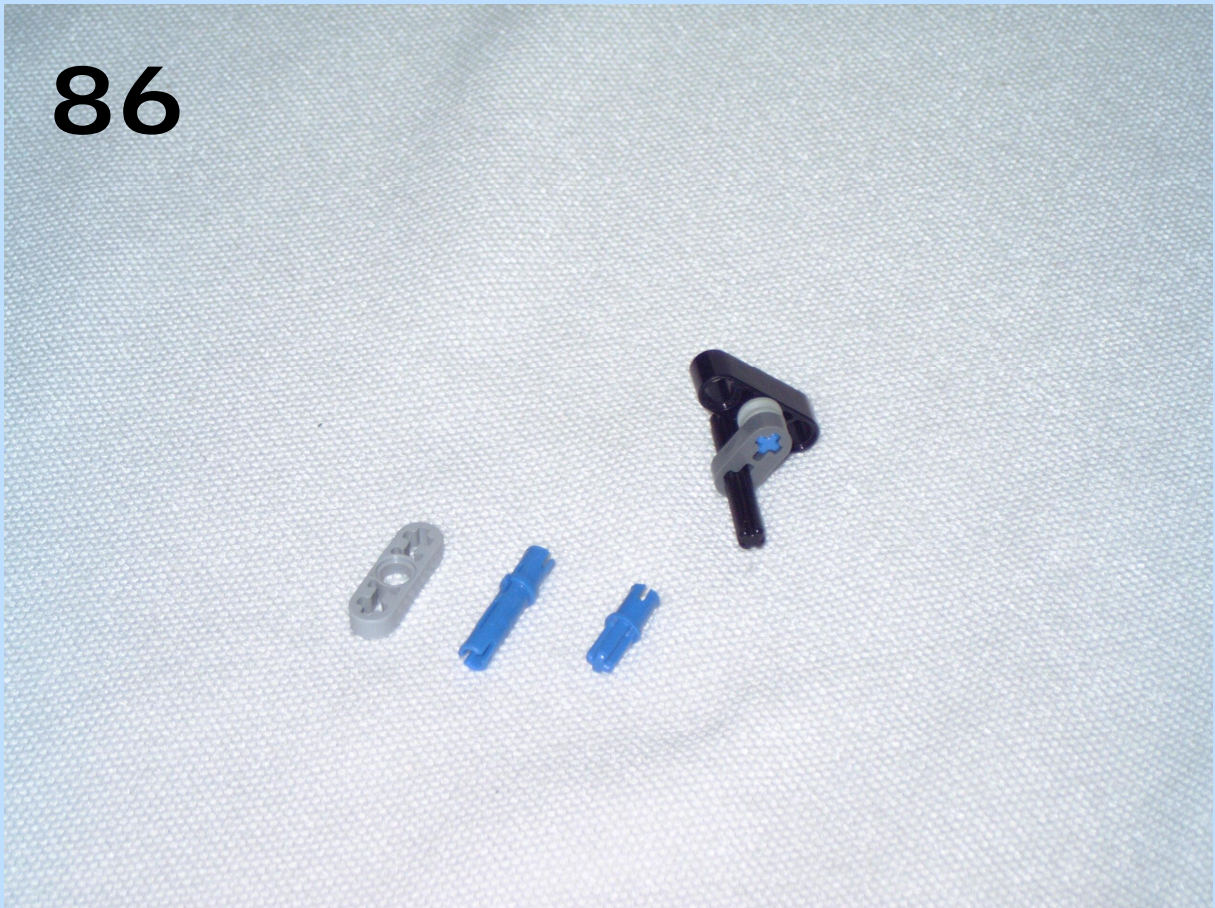

87

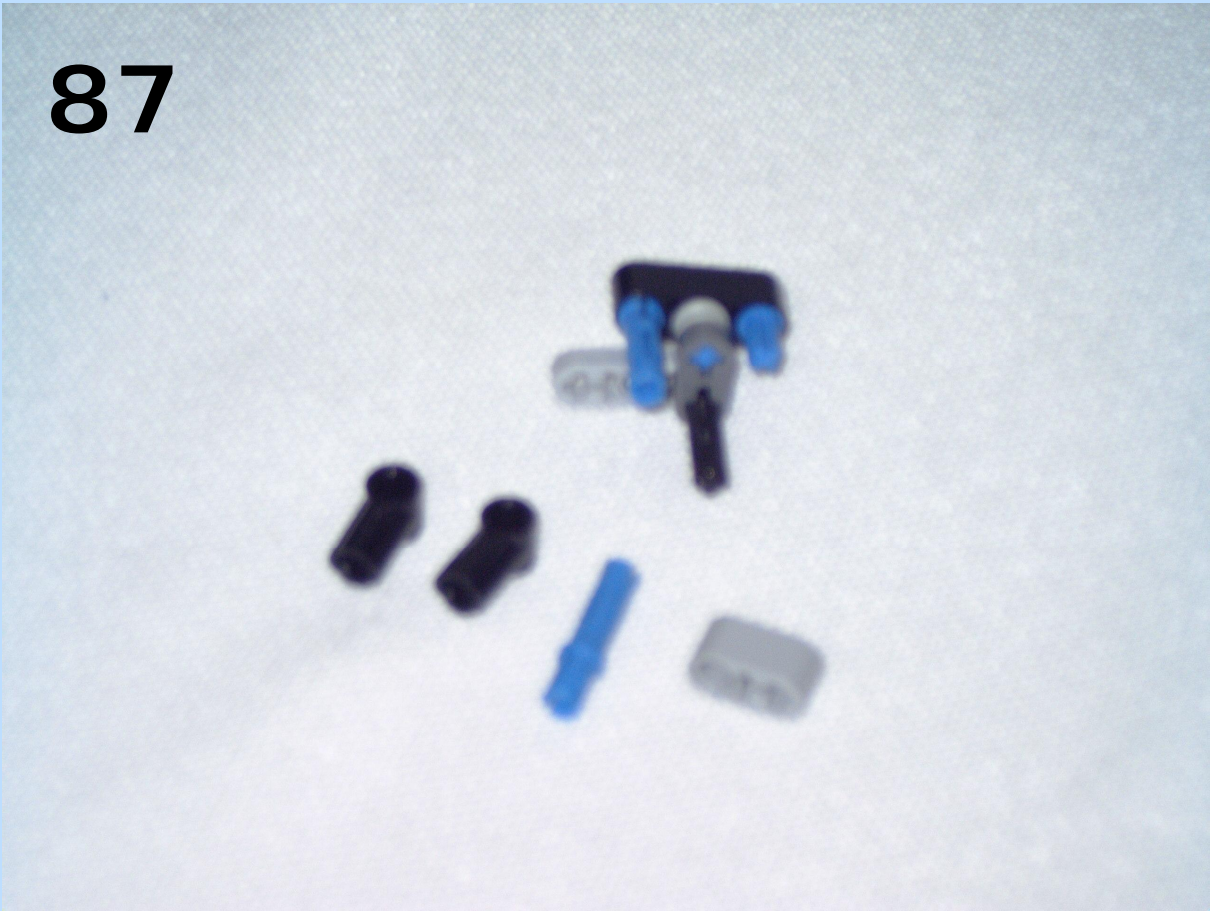

88

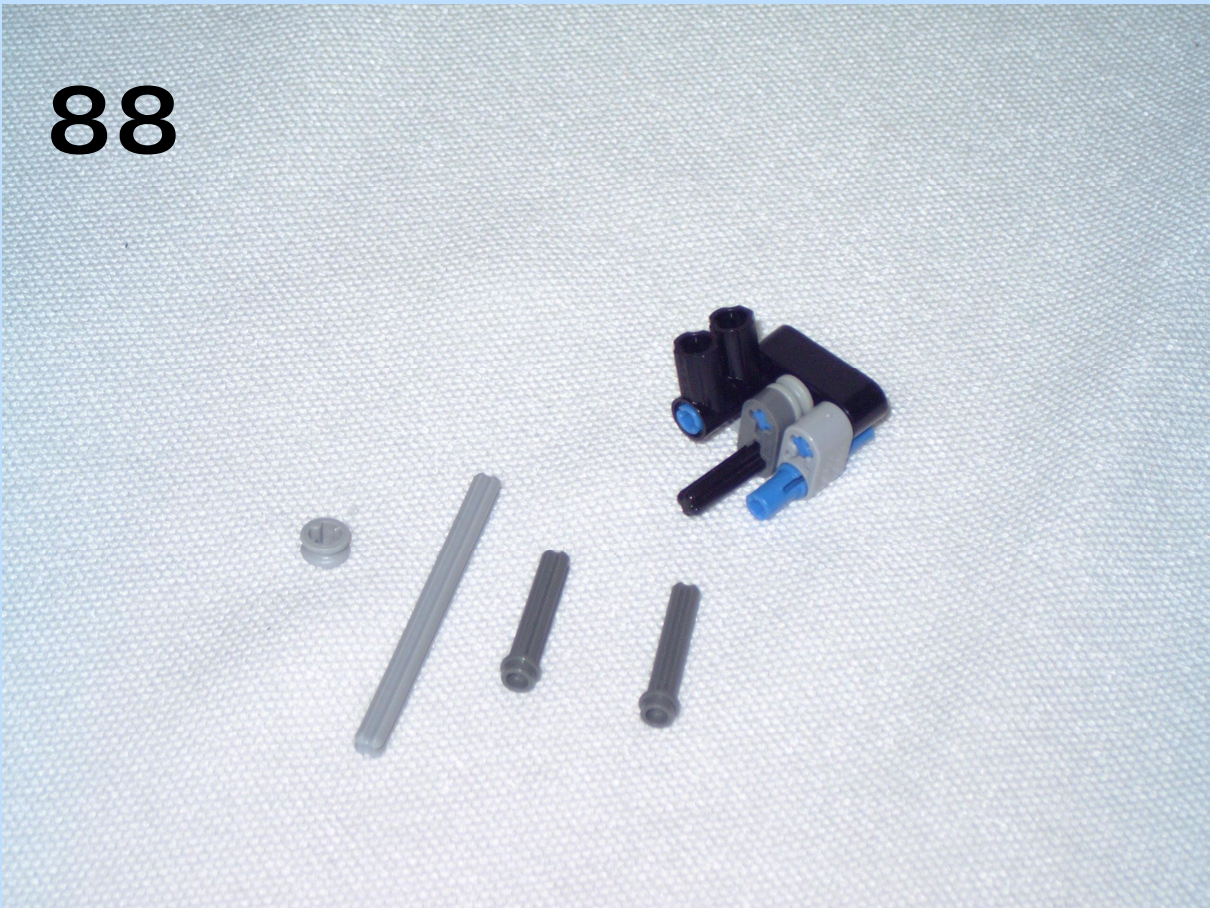

89

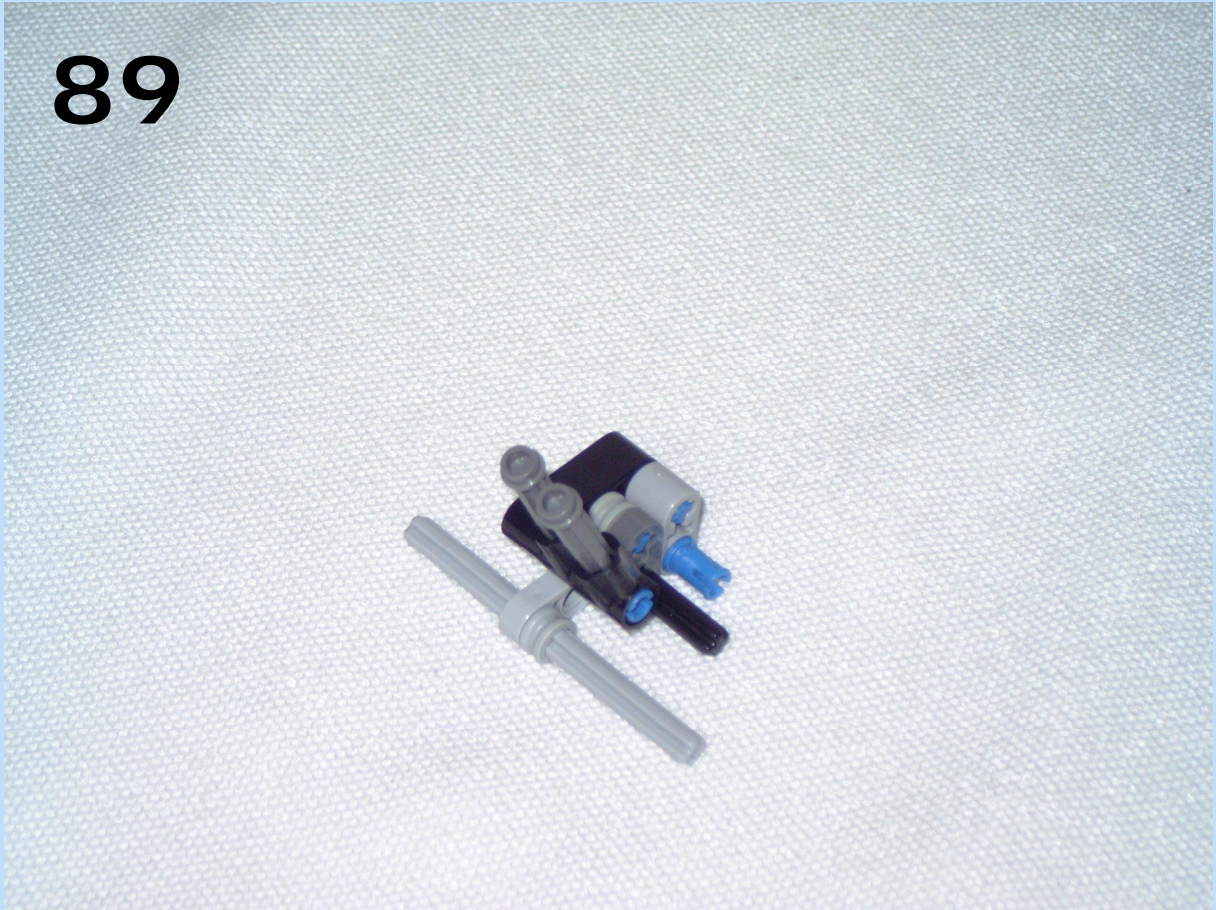

90

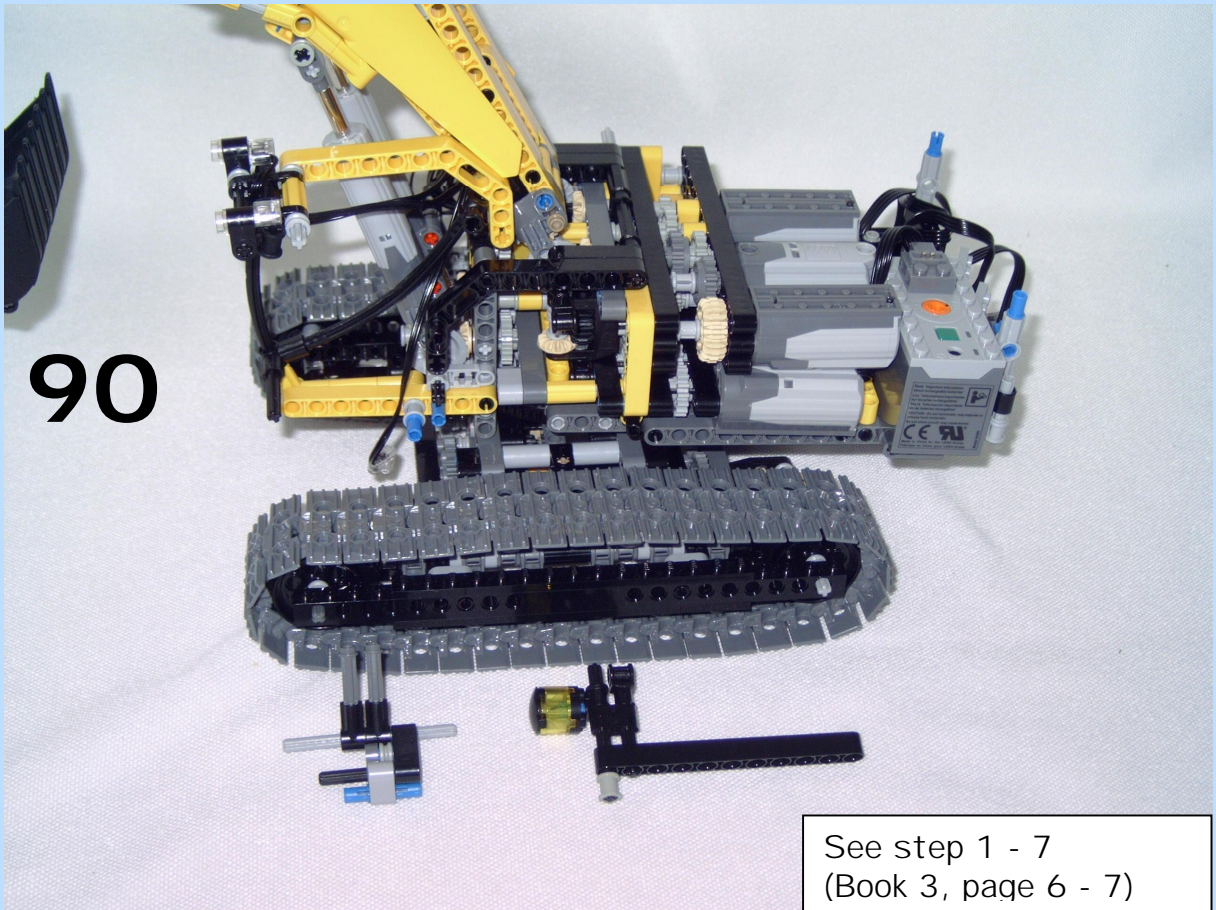

See step 1 - 7
(Book 3, page 6 - 7)

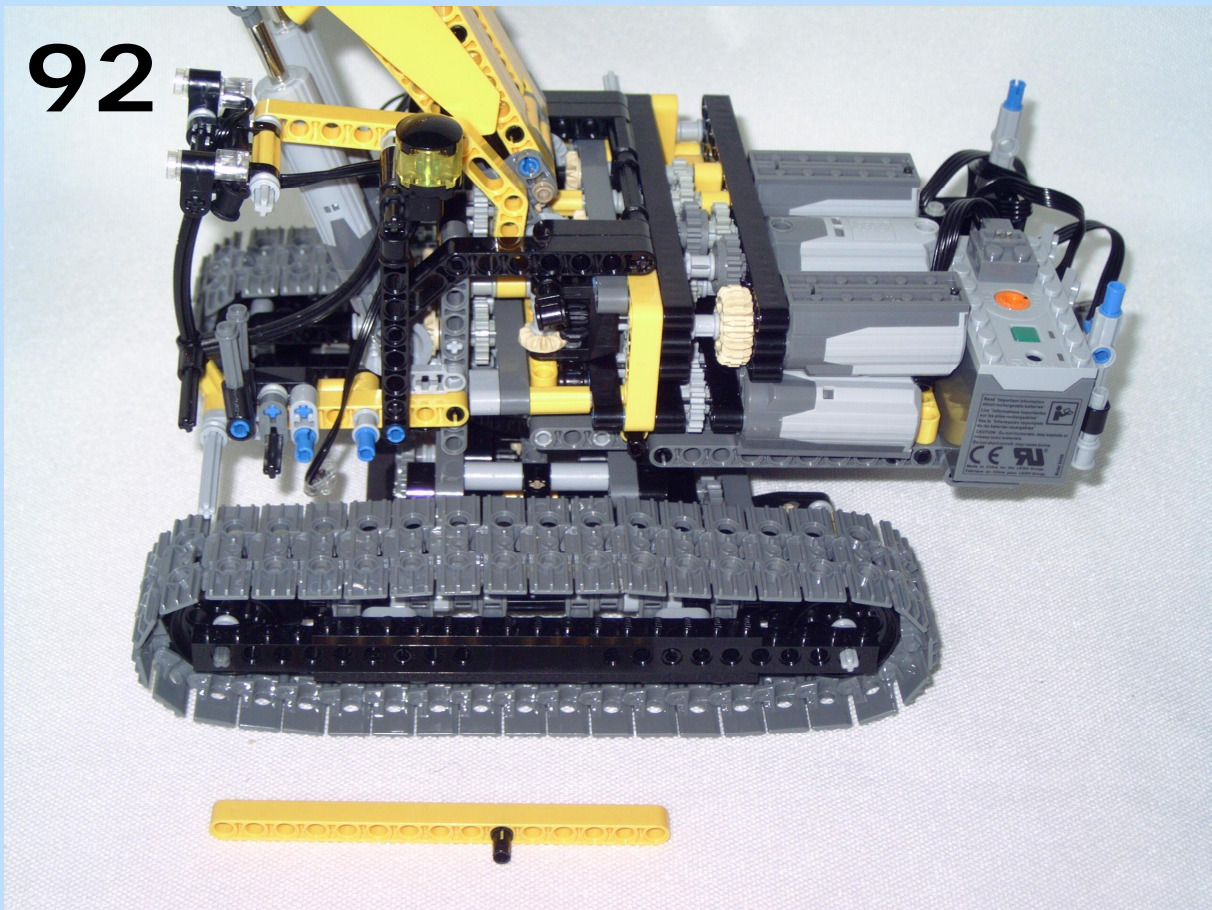
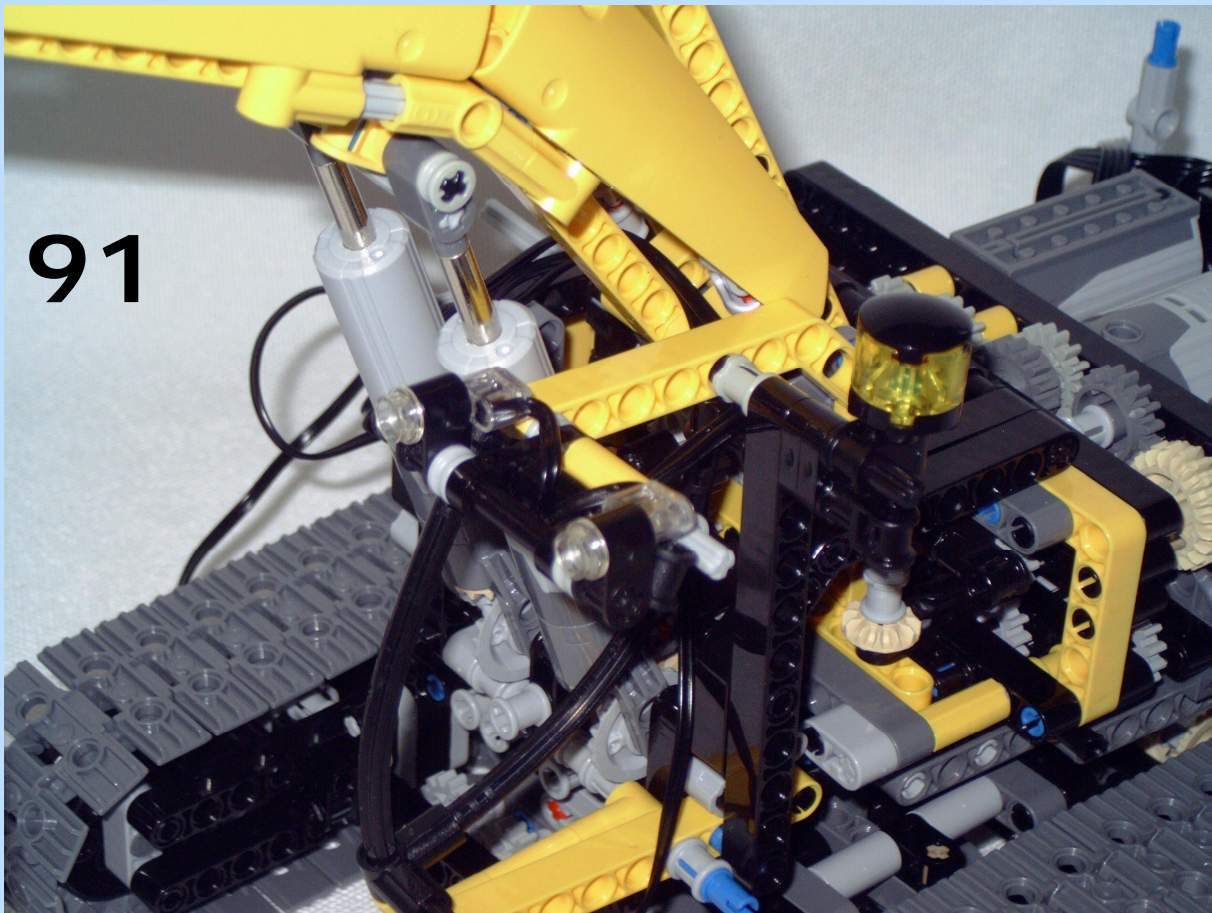

93

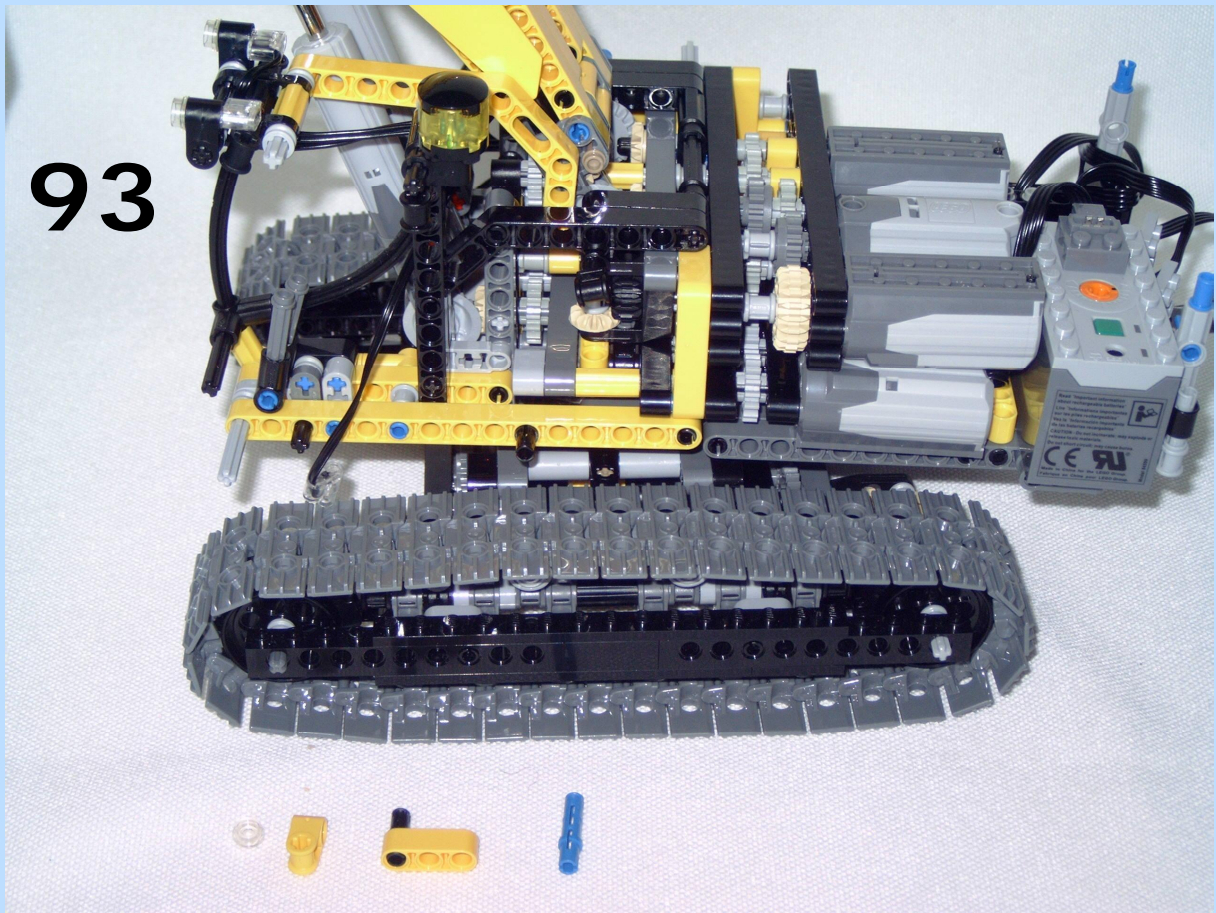

94

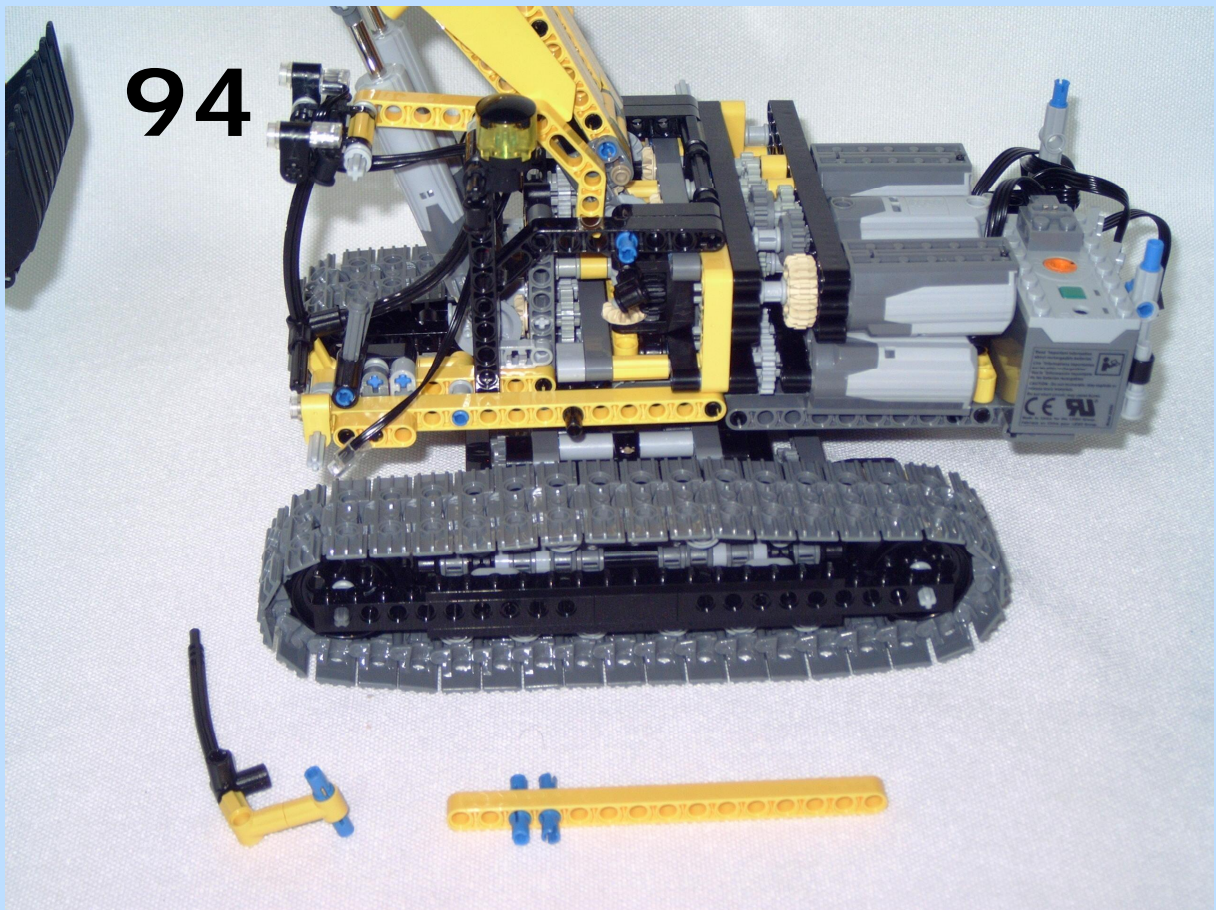

95

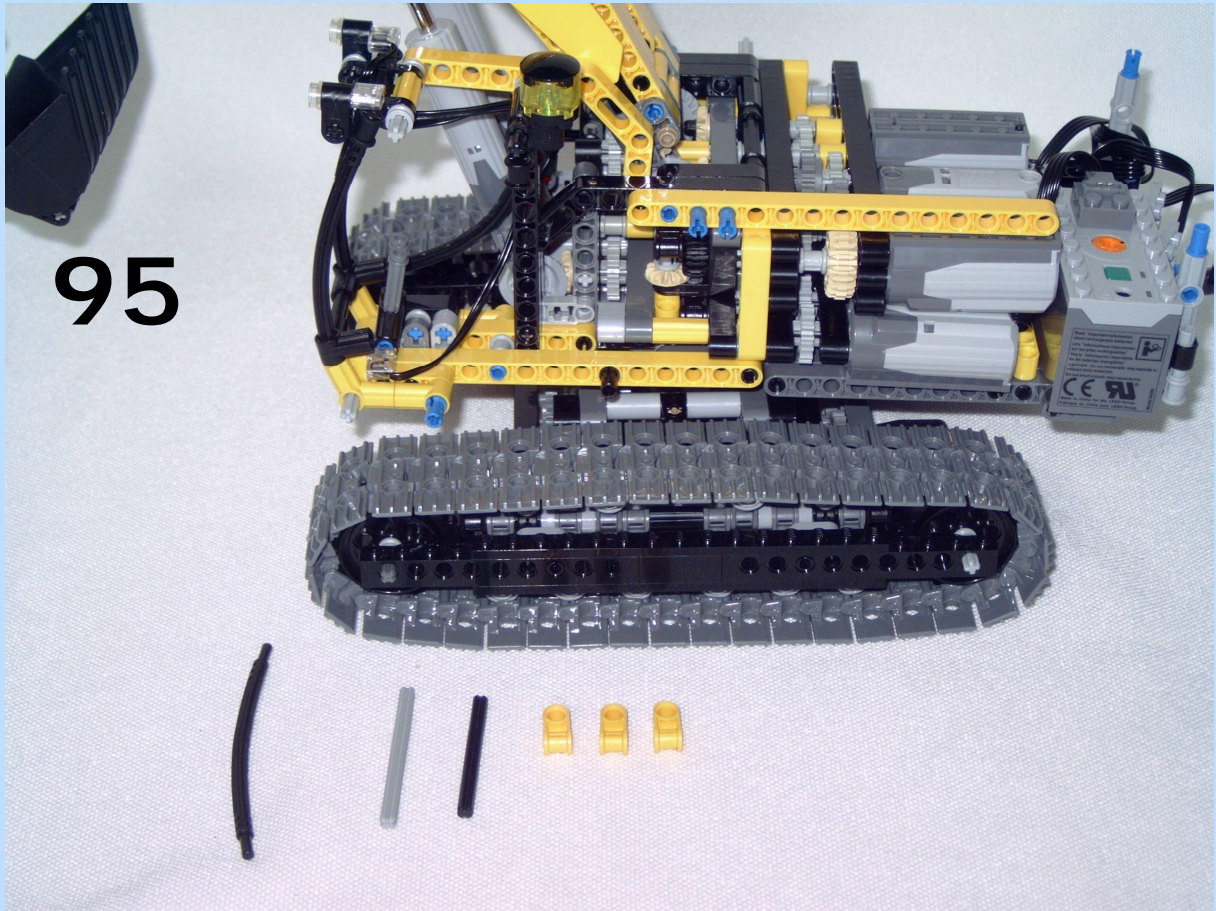

96

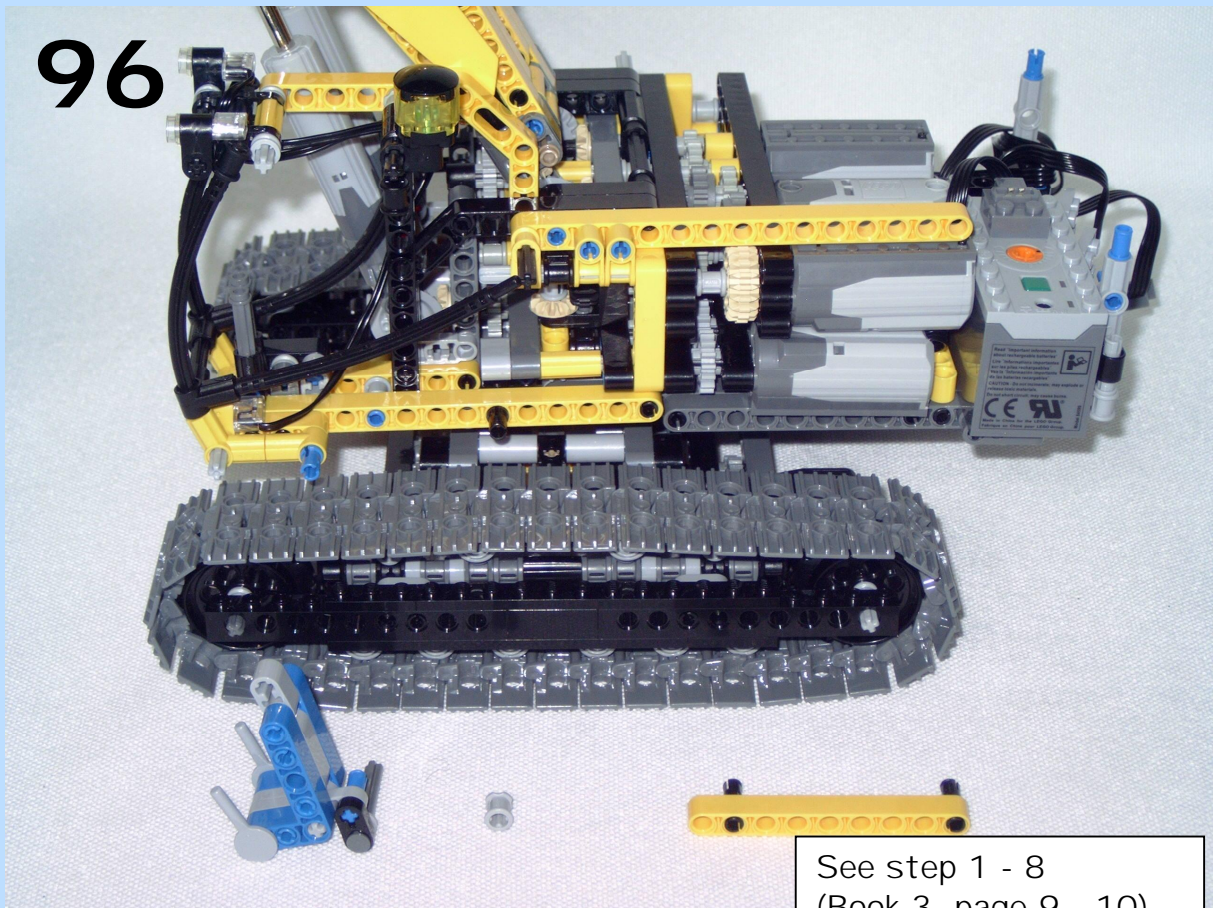

See step 1 - 8
(Book 3, page 9 - 10)

97

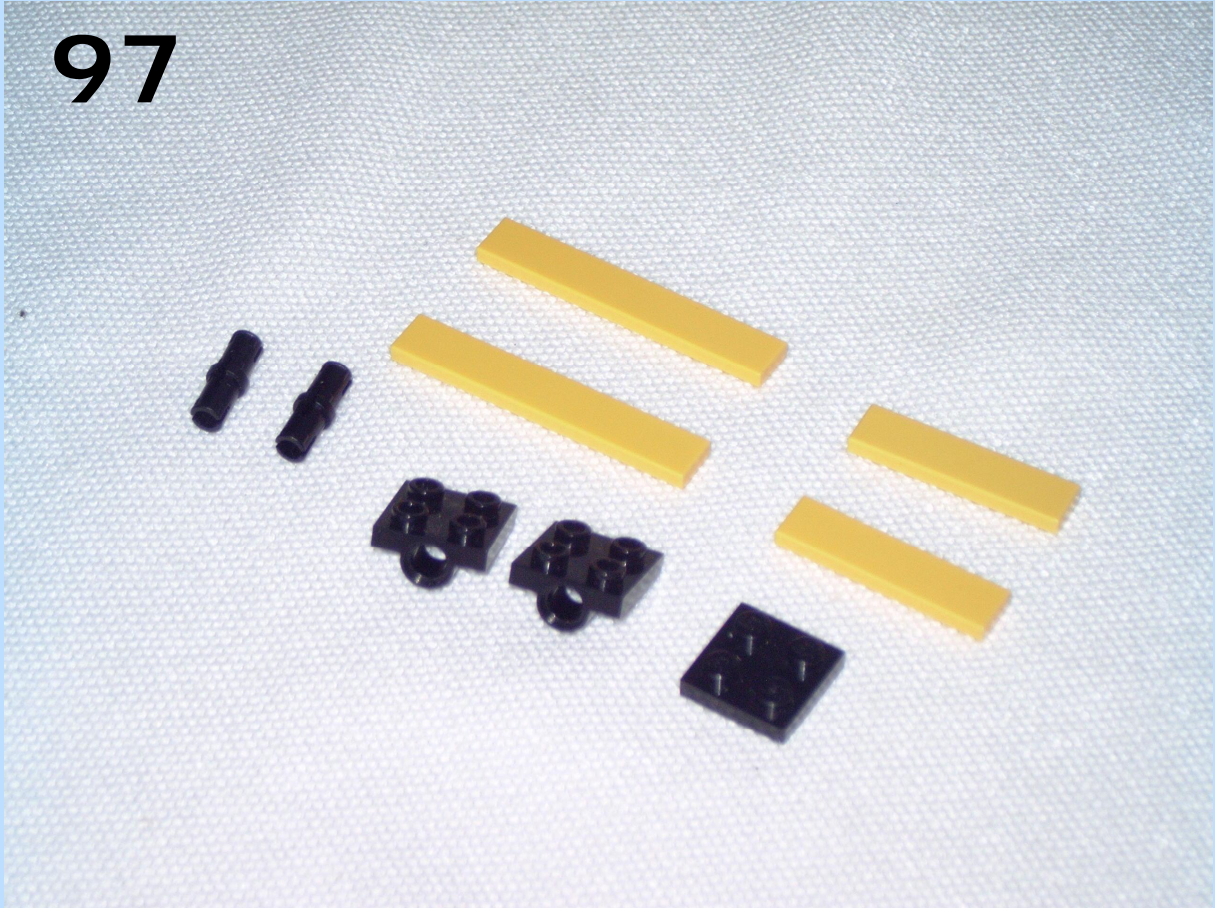

98

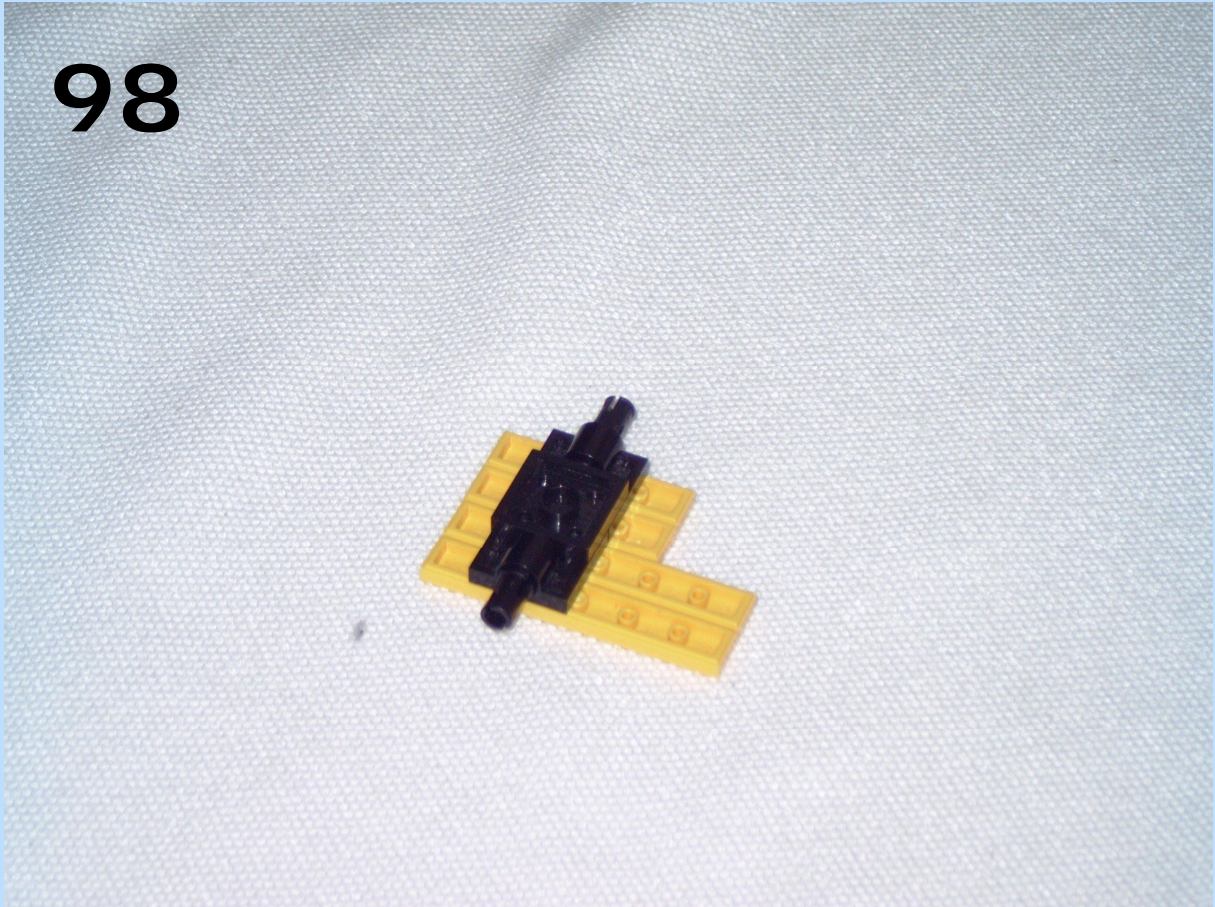

99

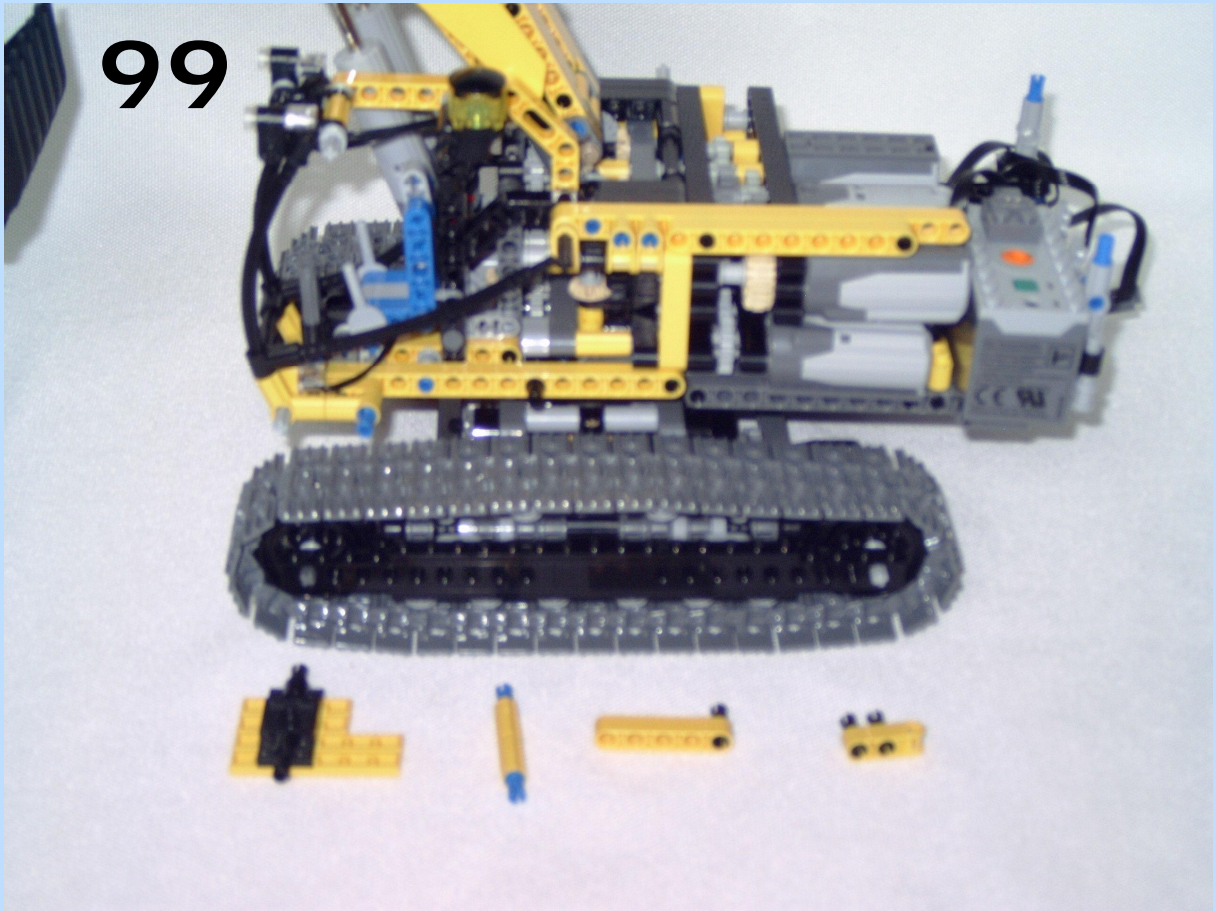

100

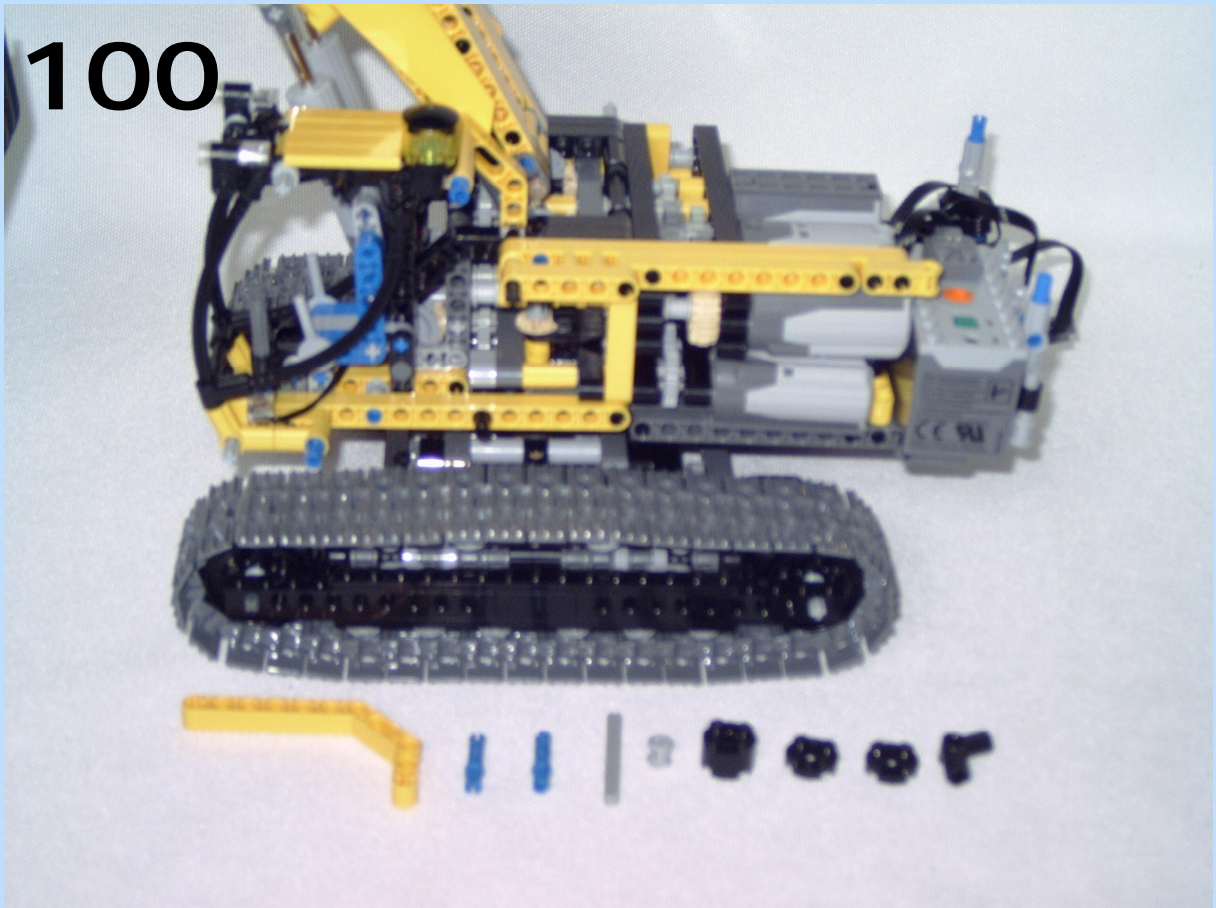

101

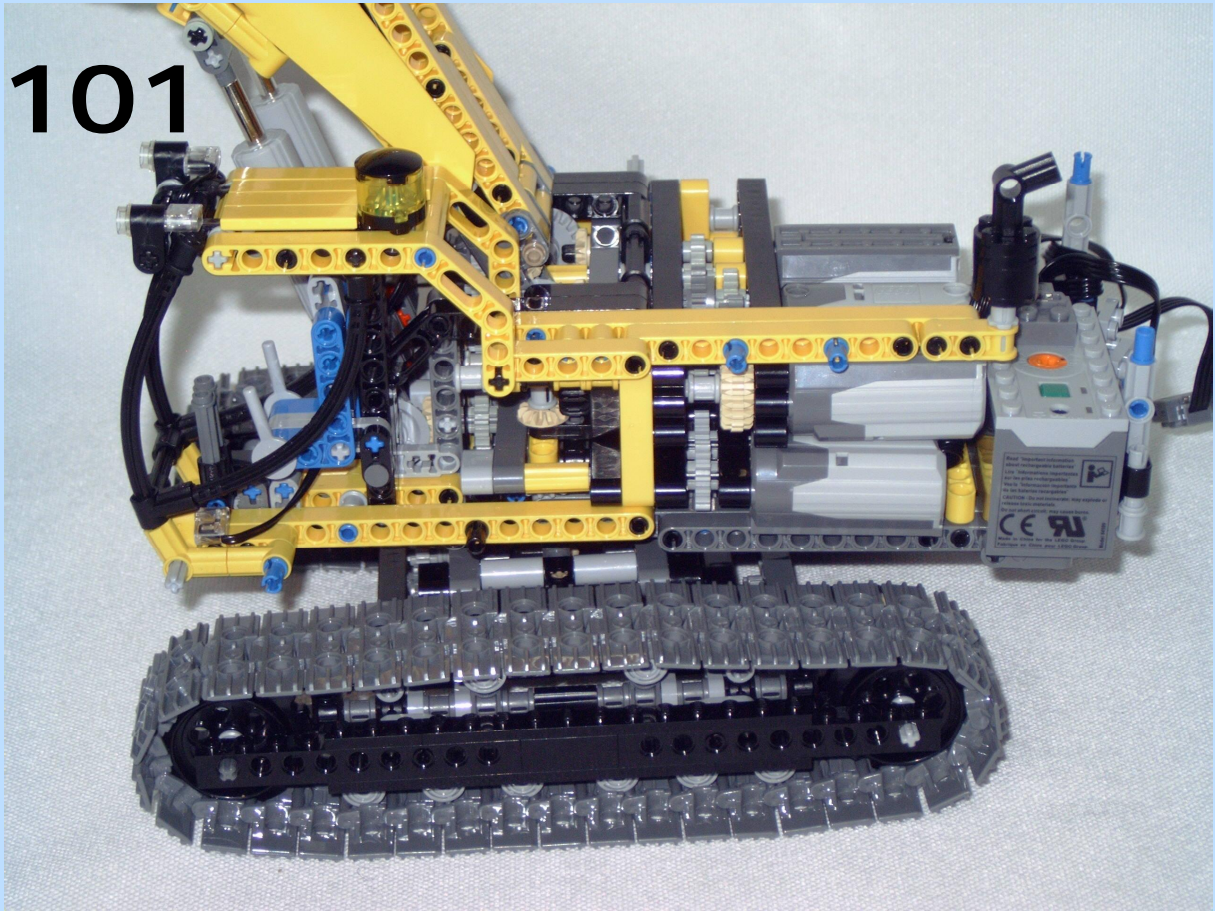

102

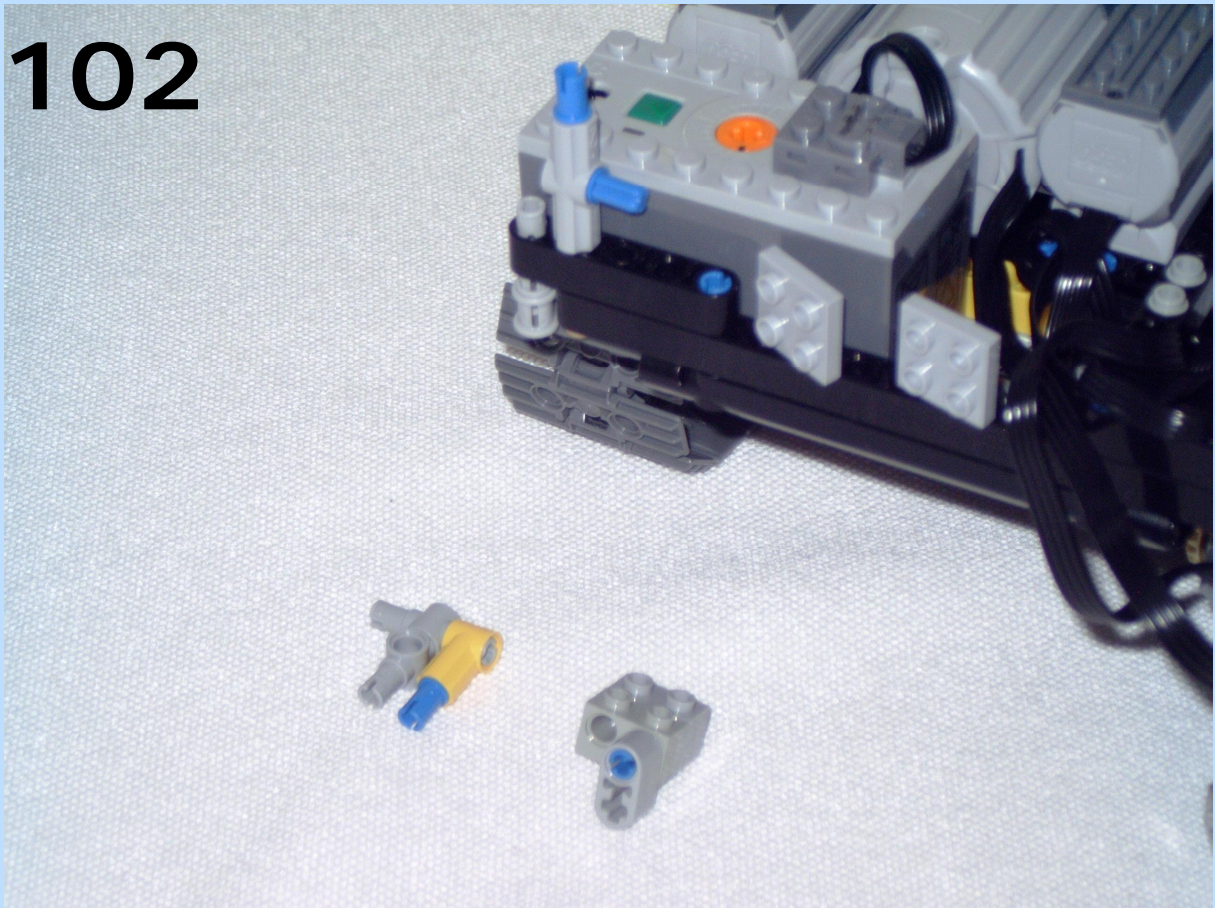

103

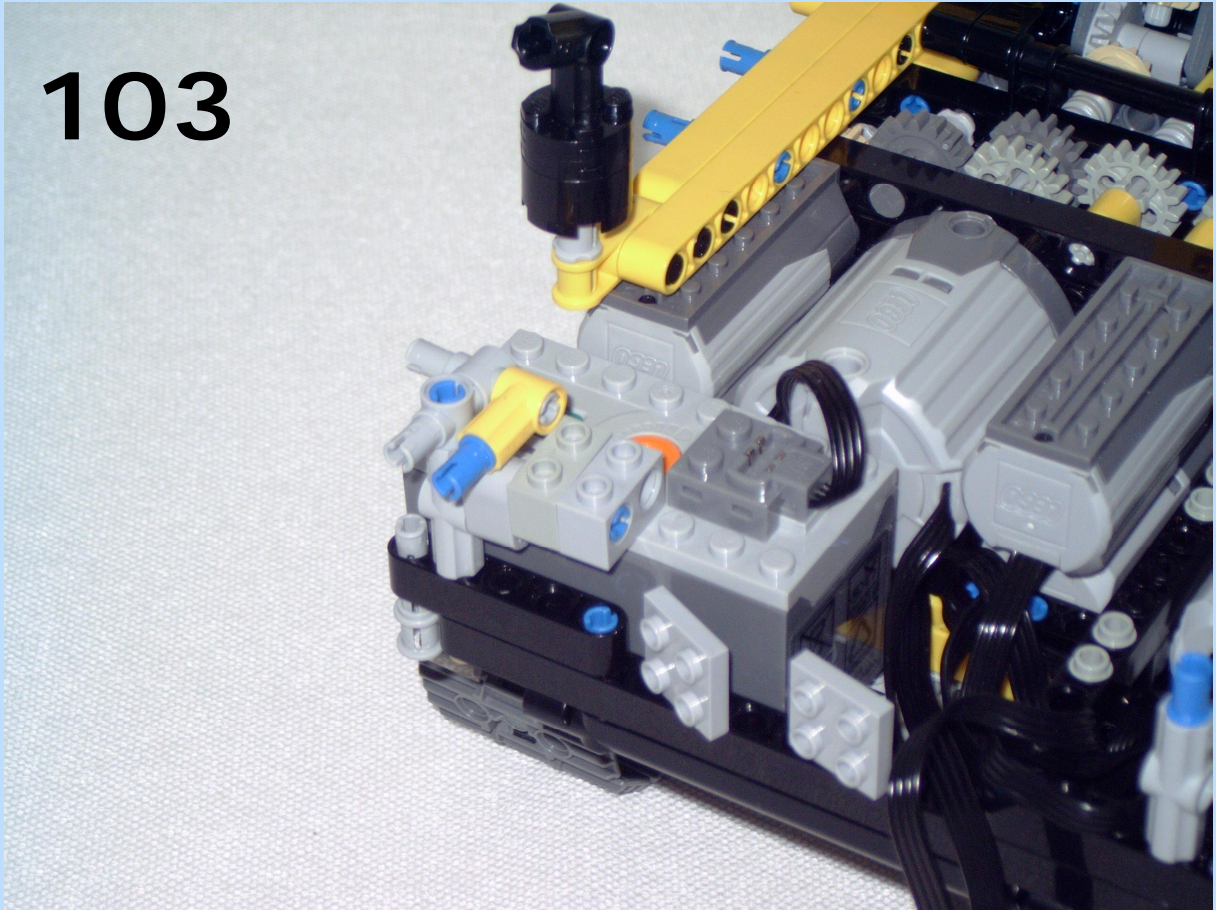

104

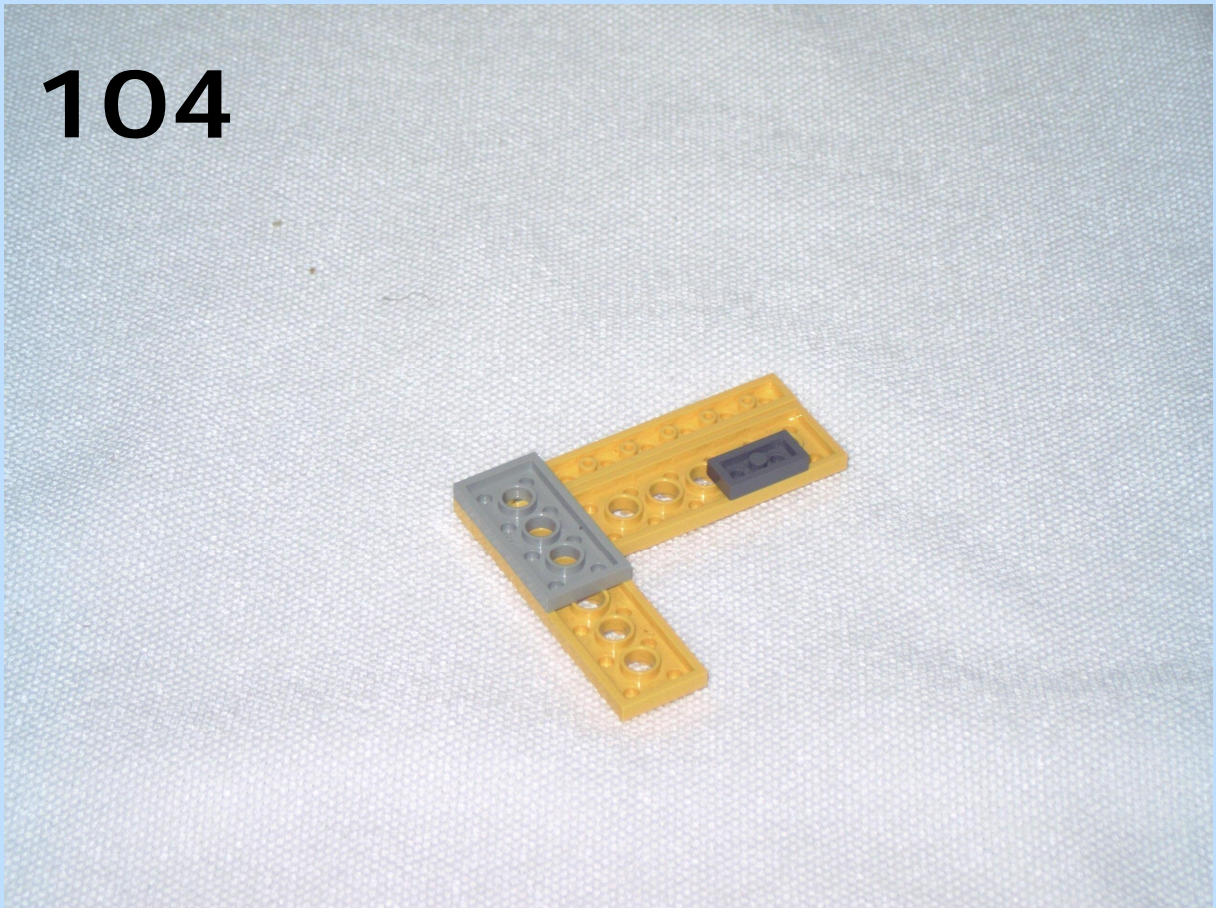

105

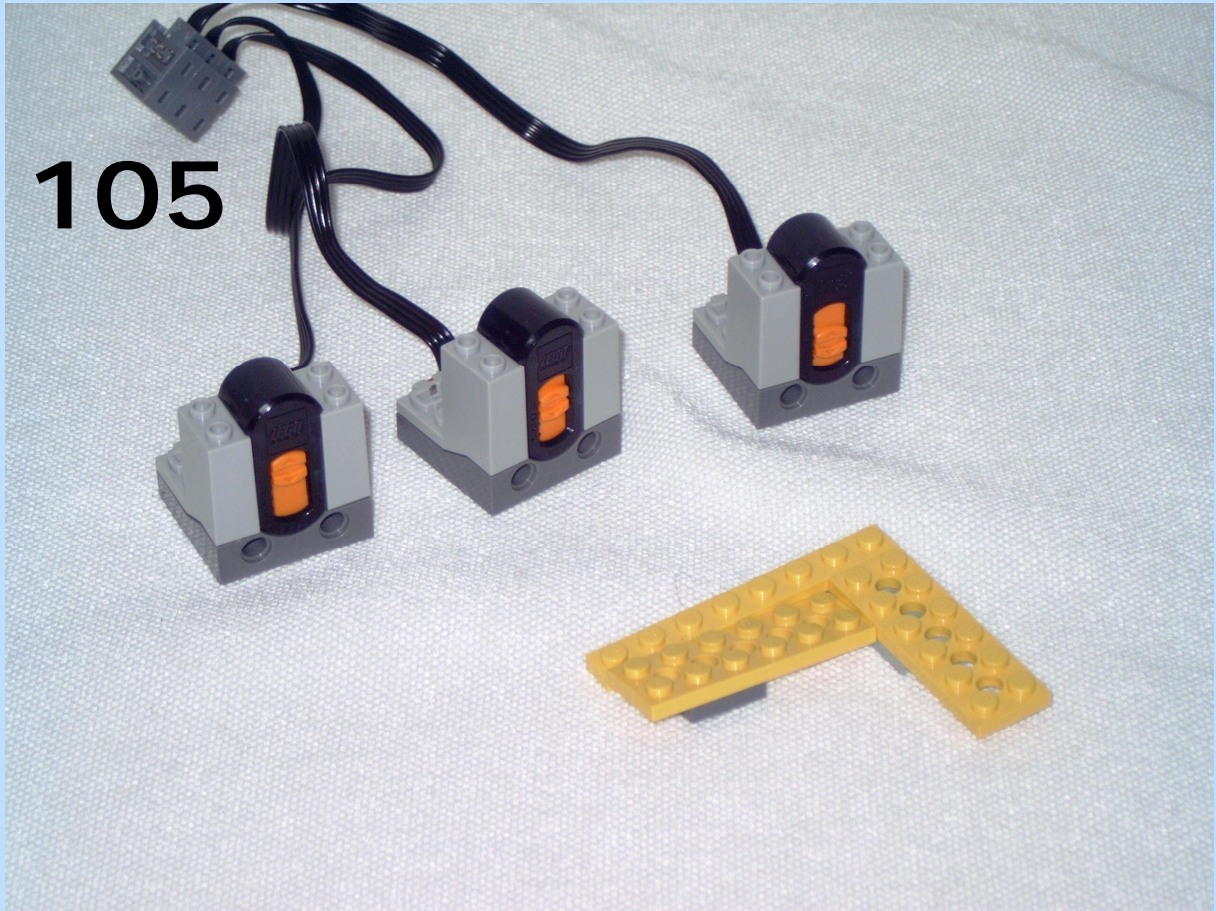

106

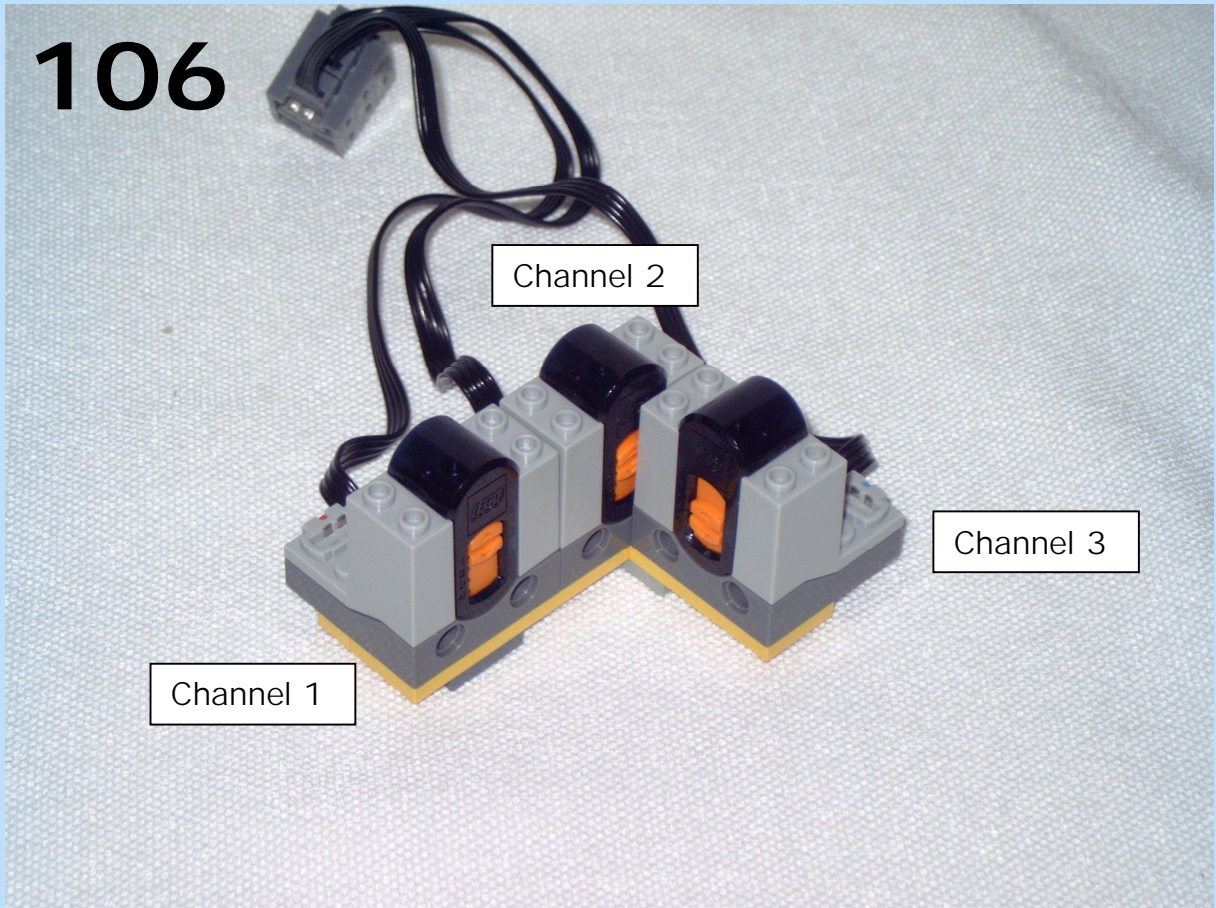

107

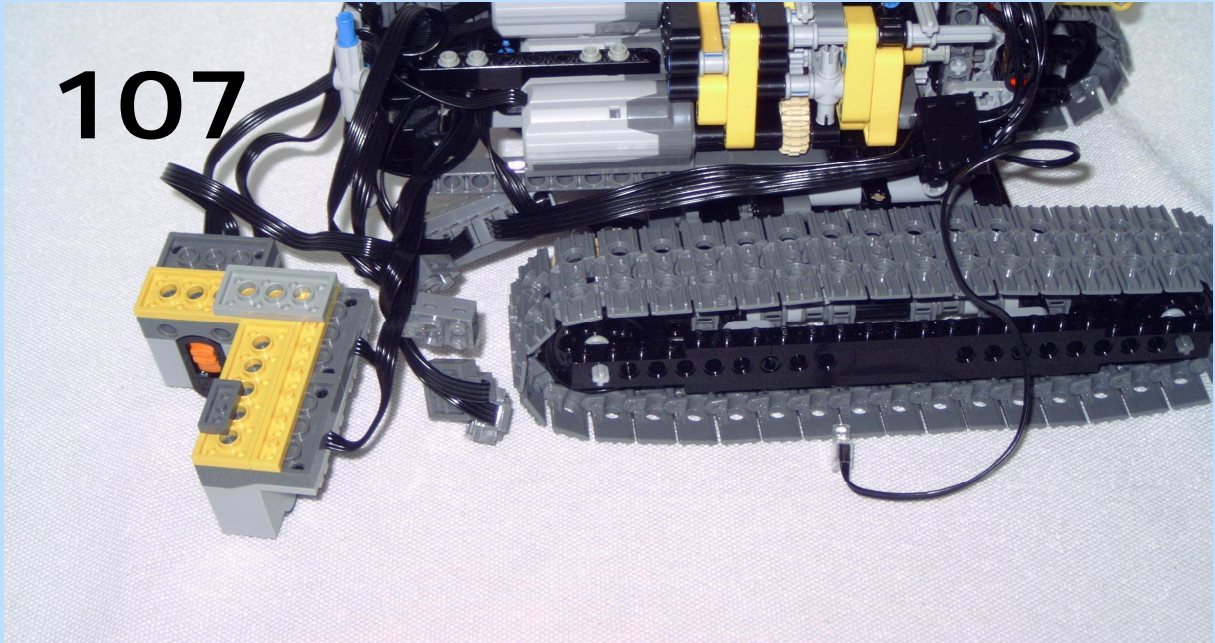

Connections:

- Slew: Ch 1 Red
- Boom: Ch1 Blue
- Drive left: Ch 2 Red
- Drive Right: Ch 2 Blue
- Bucket: Ch 3 Red
- Dipper: Ch 3 Blue

108

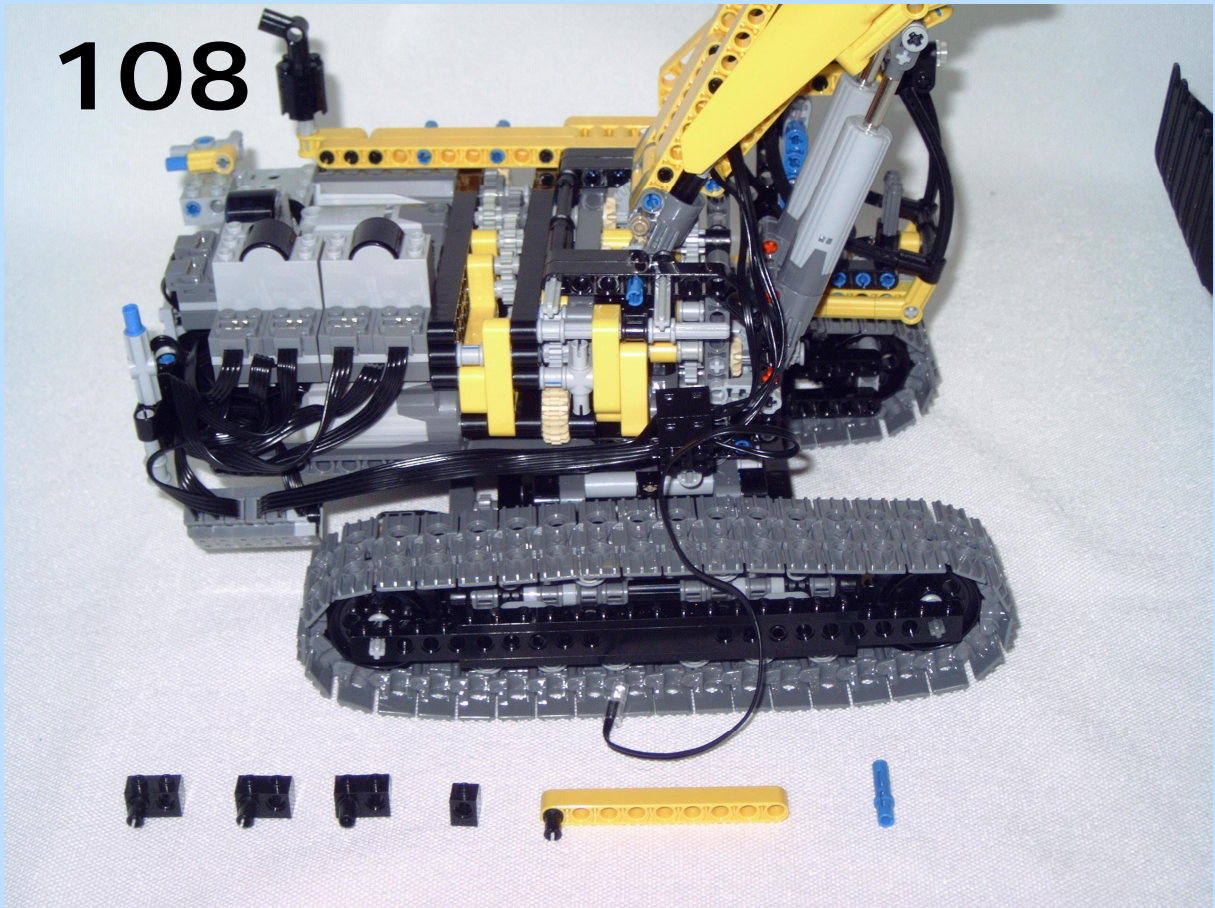

109

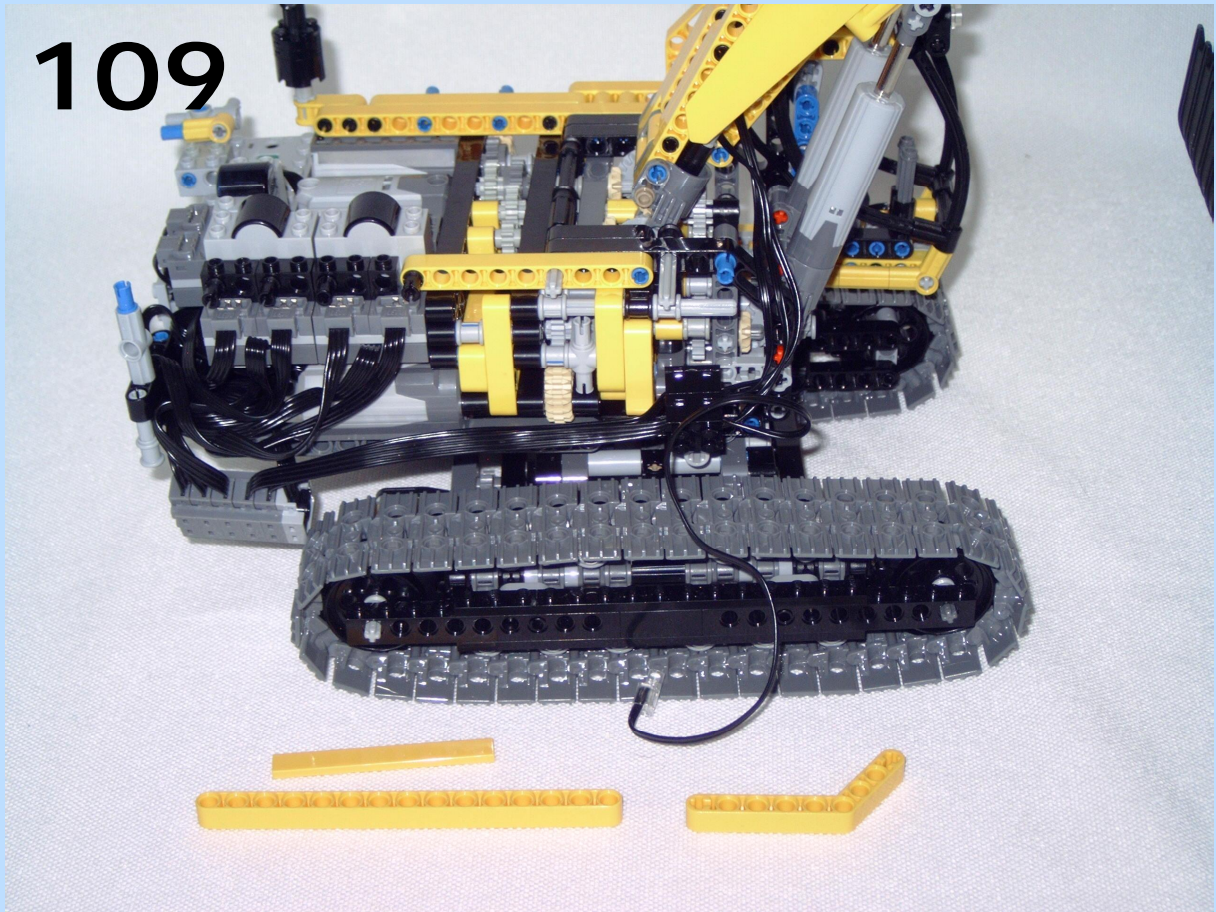

110

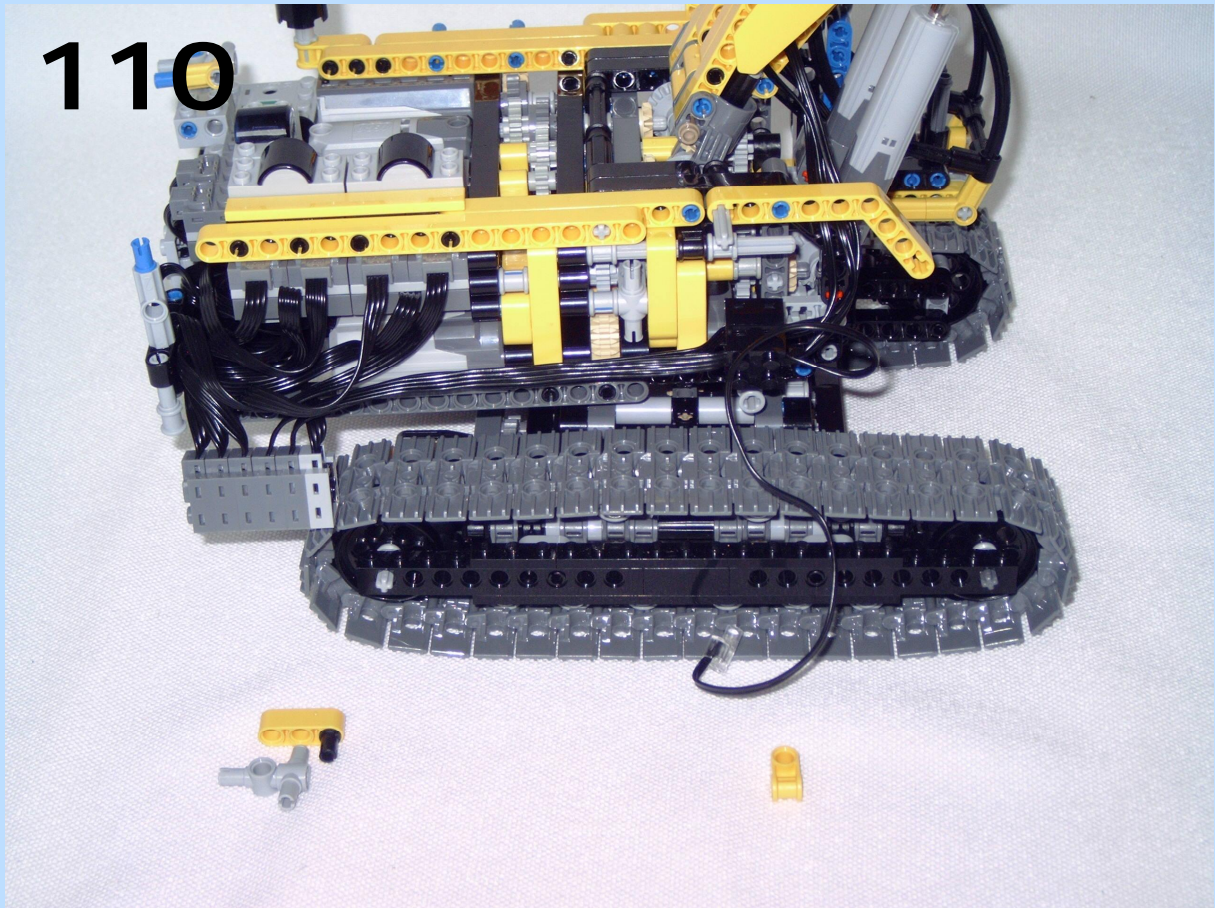

111

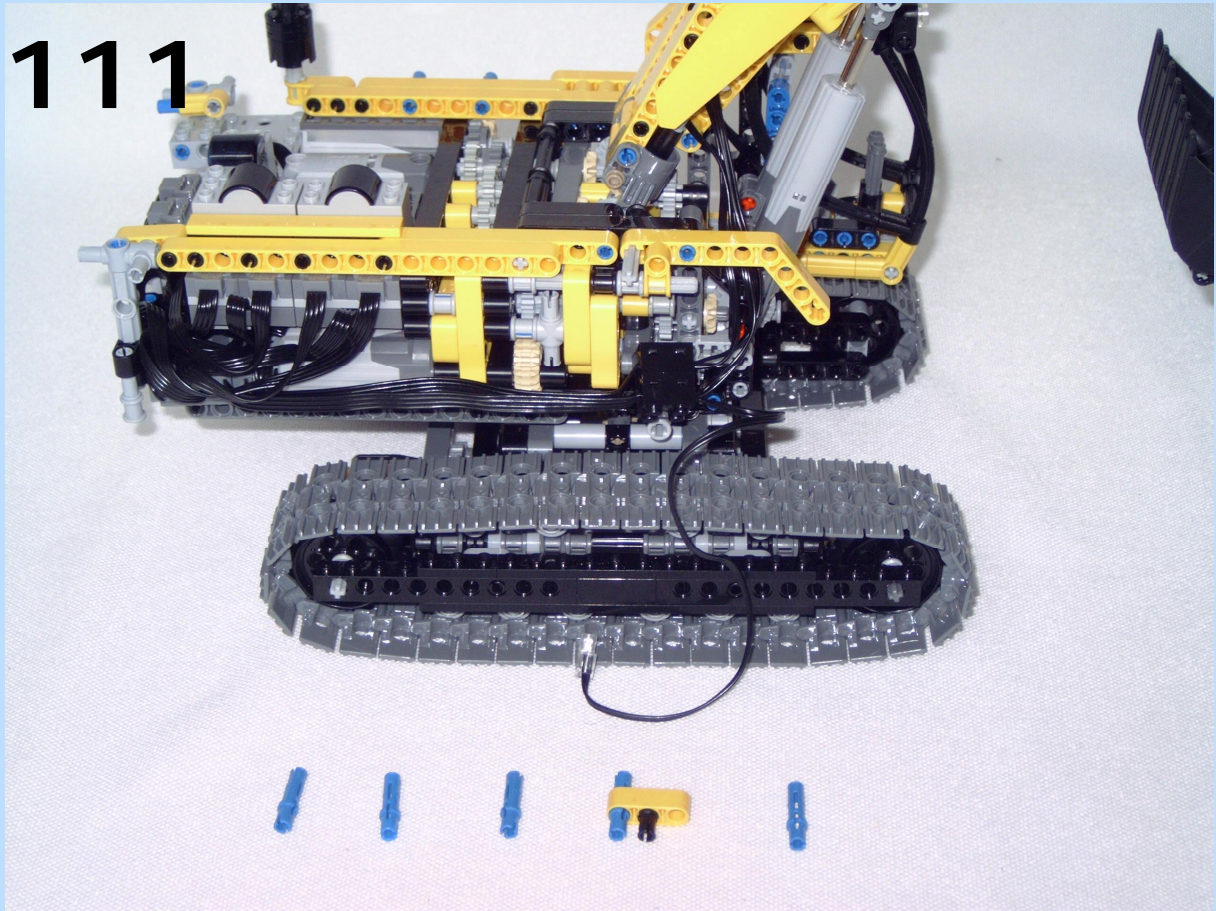

112

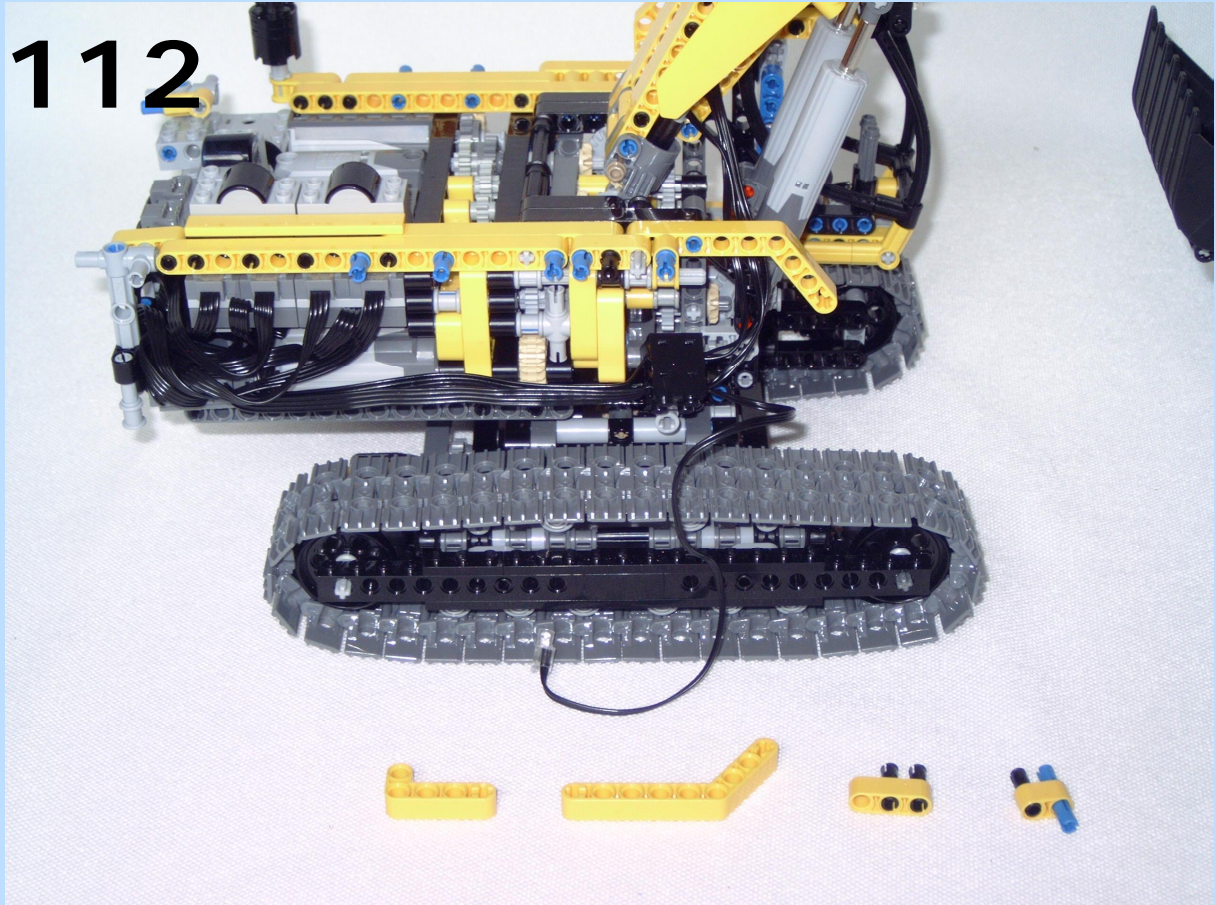

113

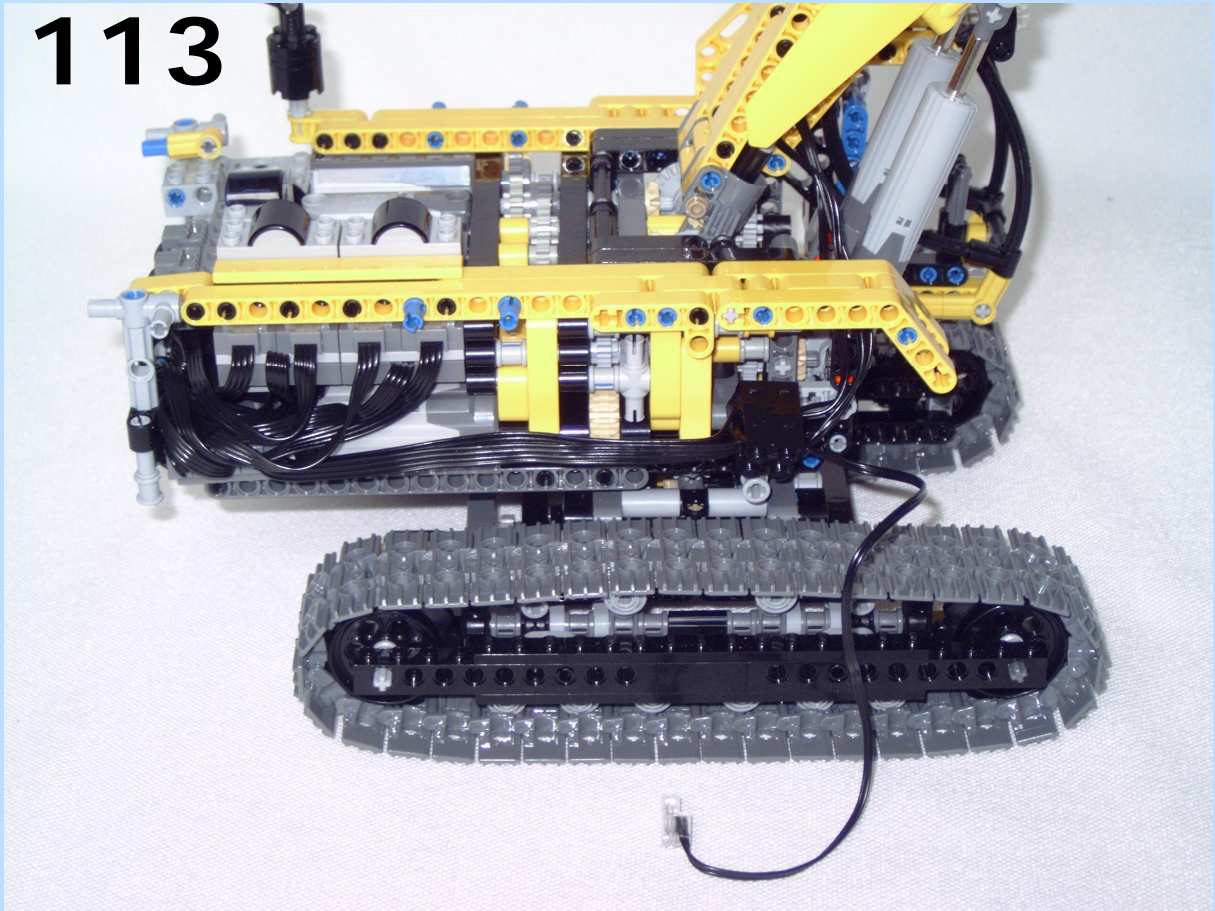

114

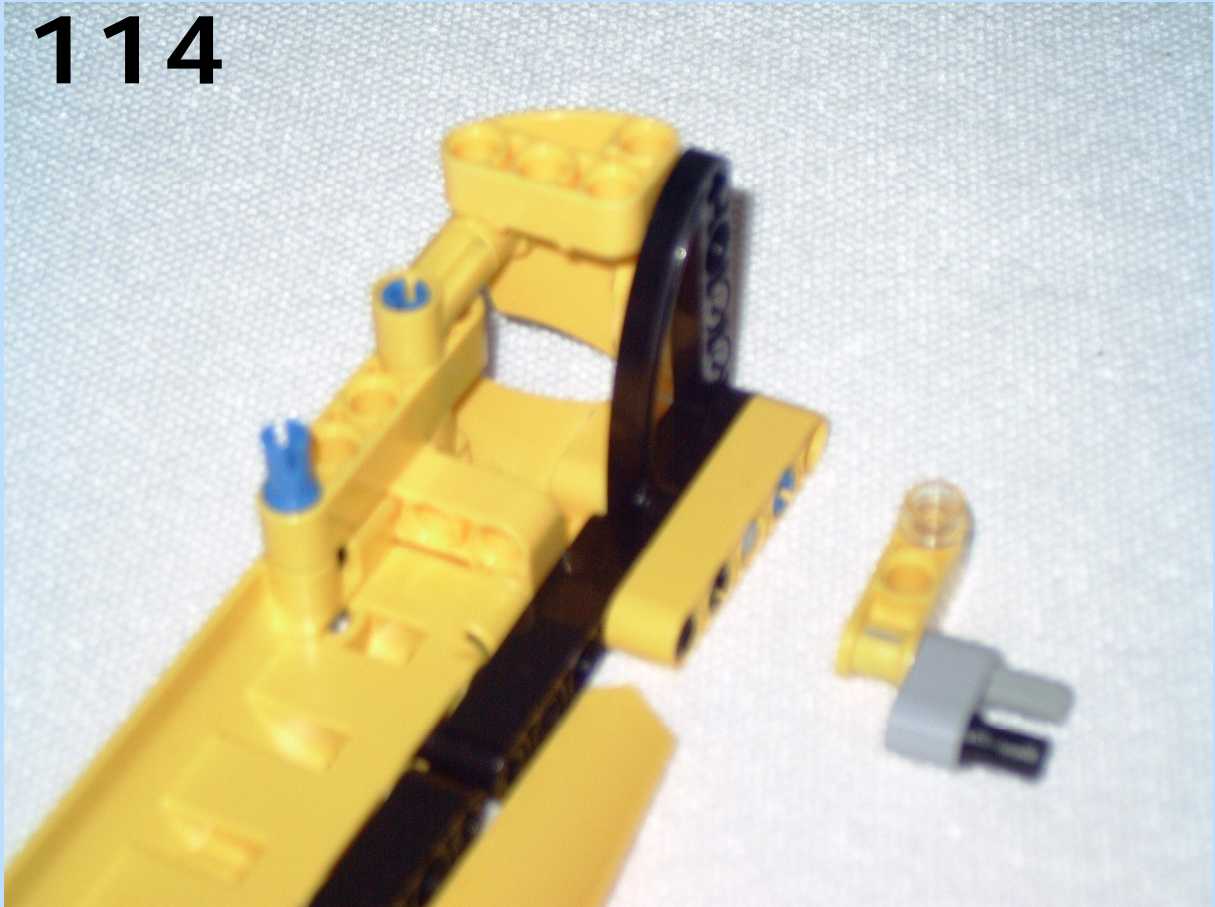

115

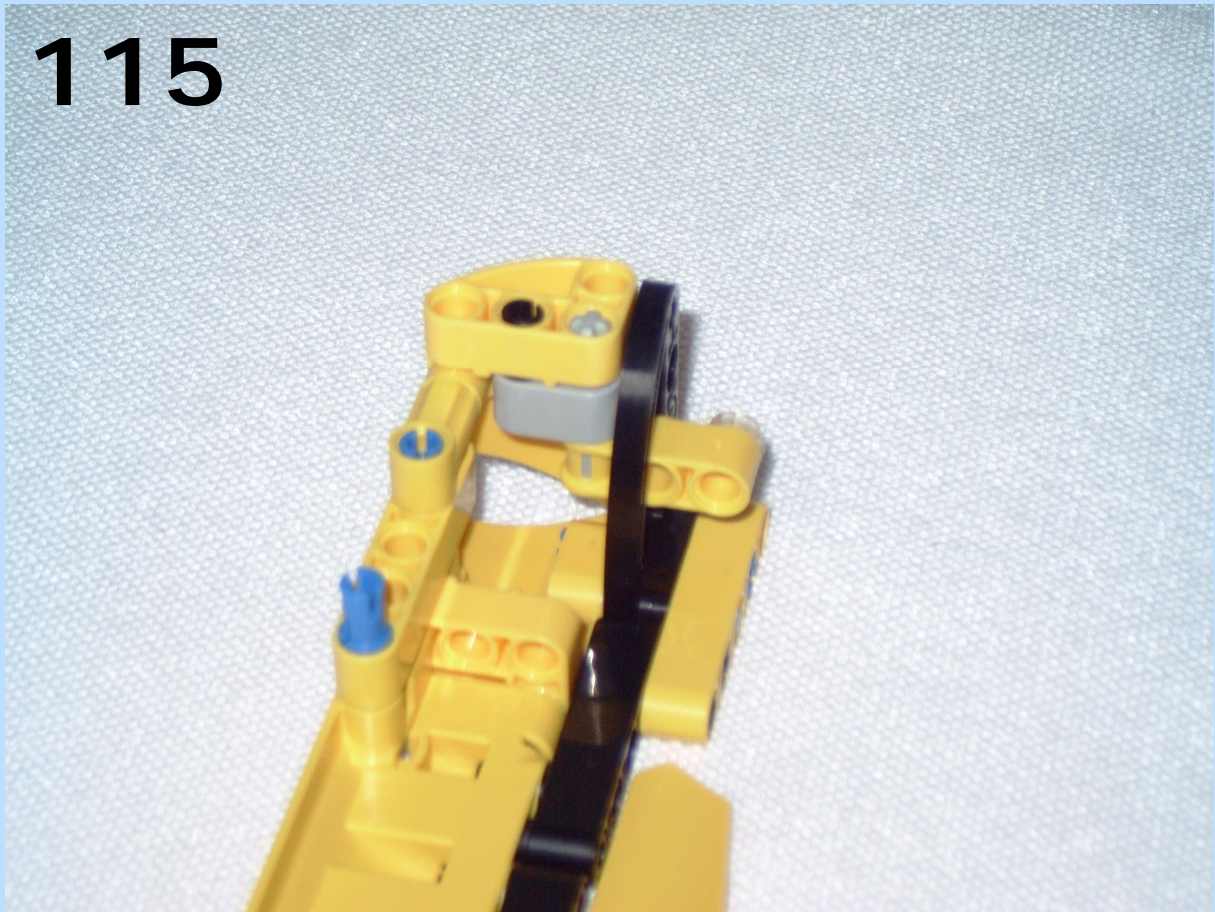

116

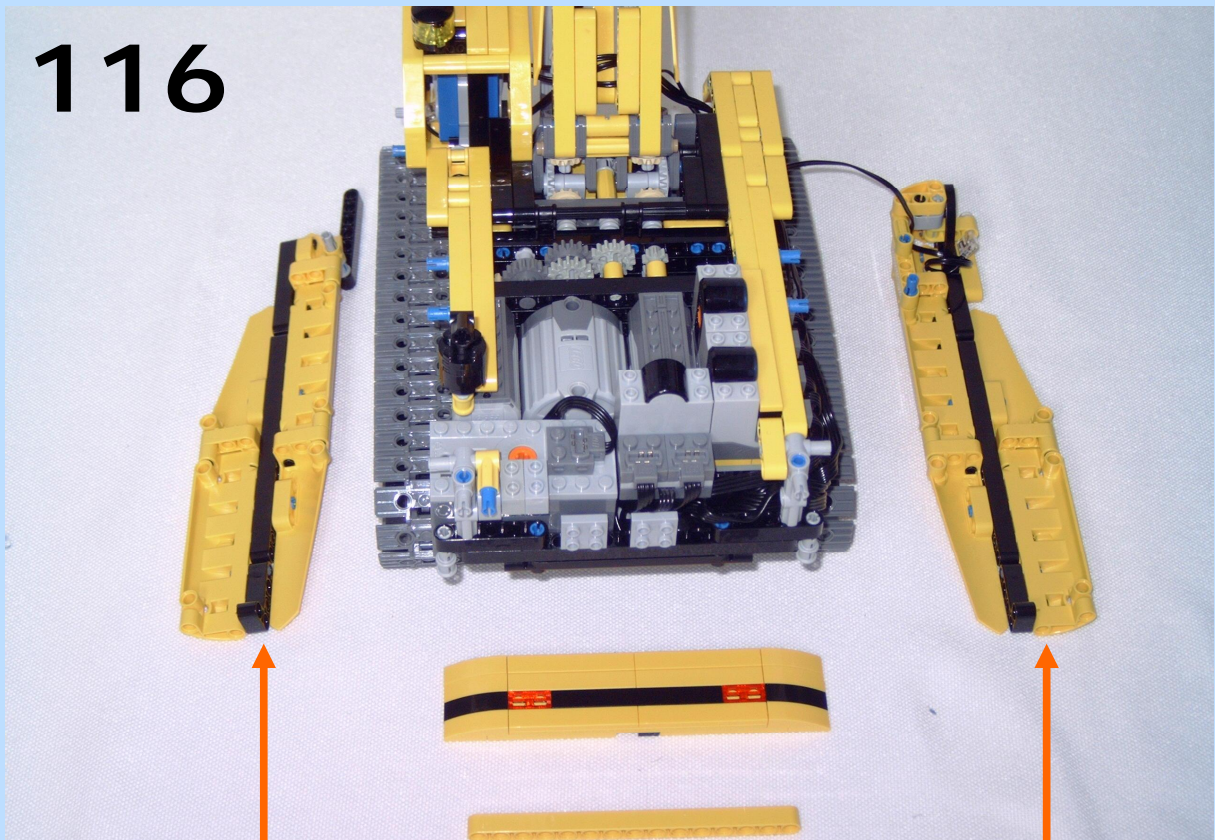

See book 3, page 19 - 25)

See book 3, page 29 - 34)

117

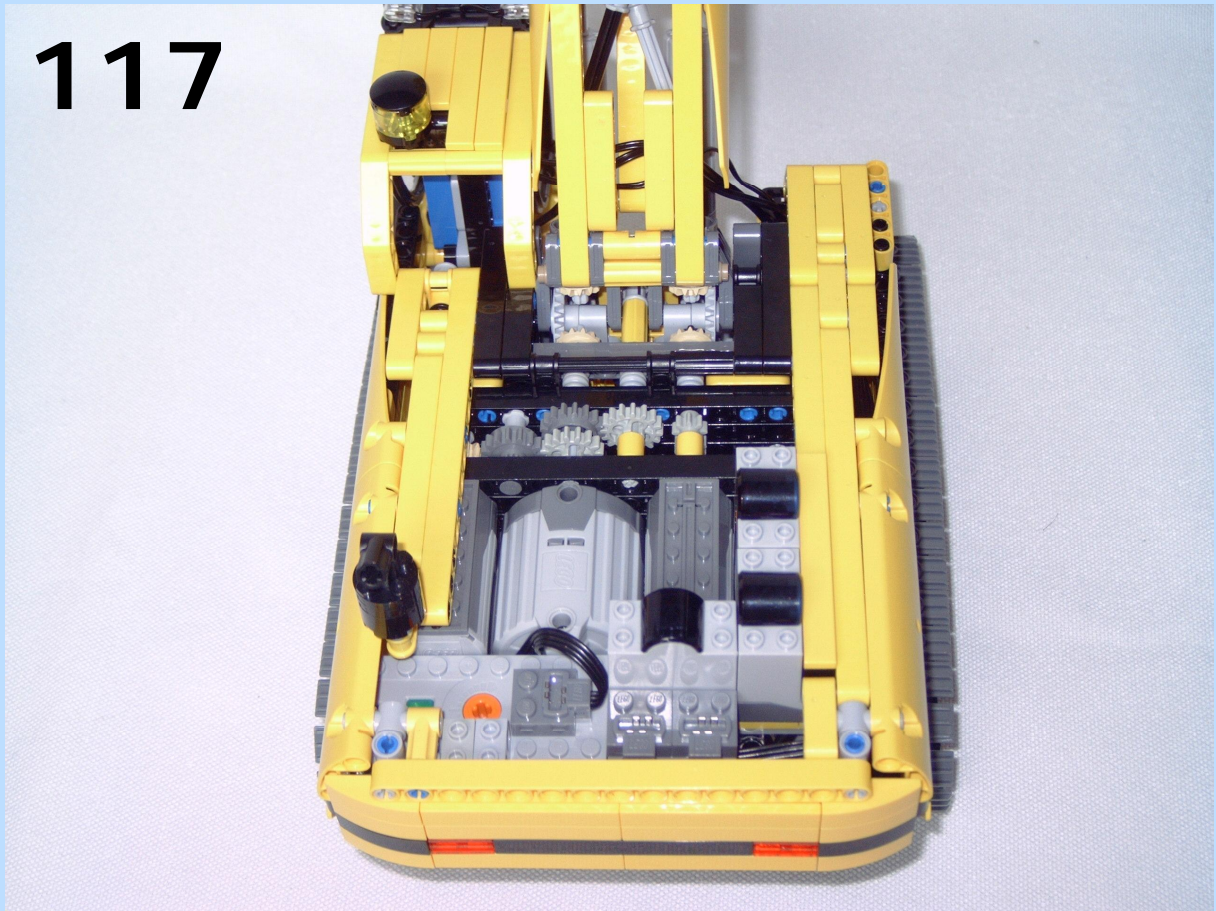

118

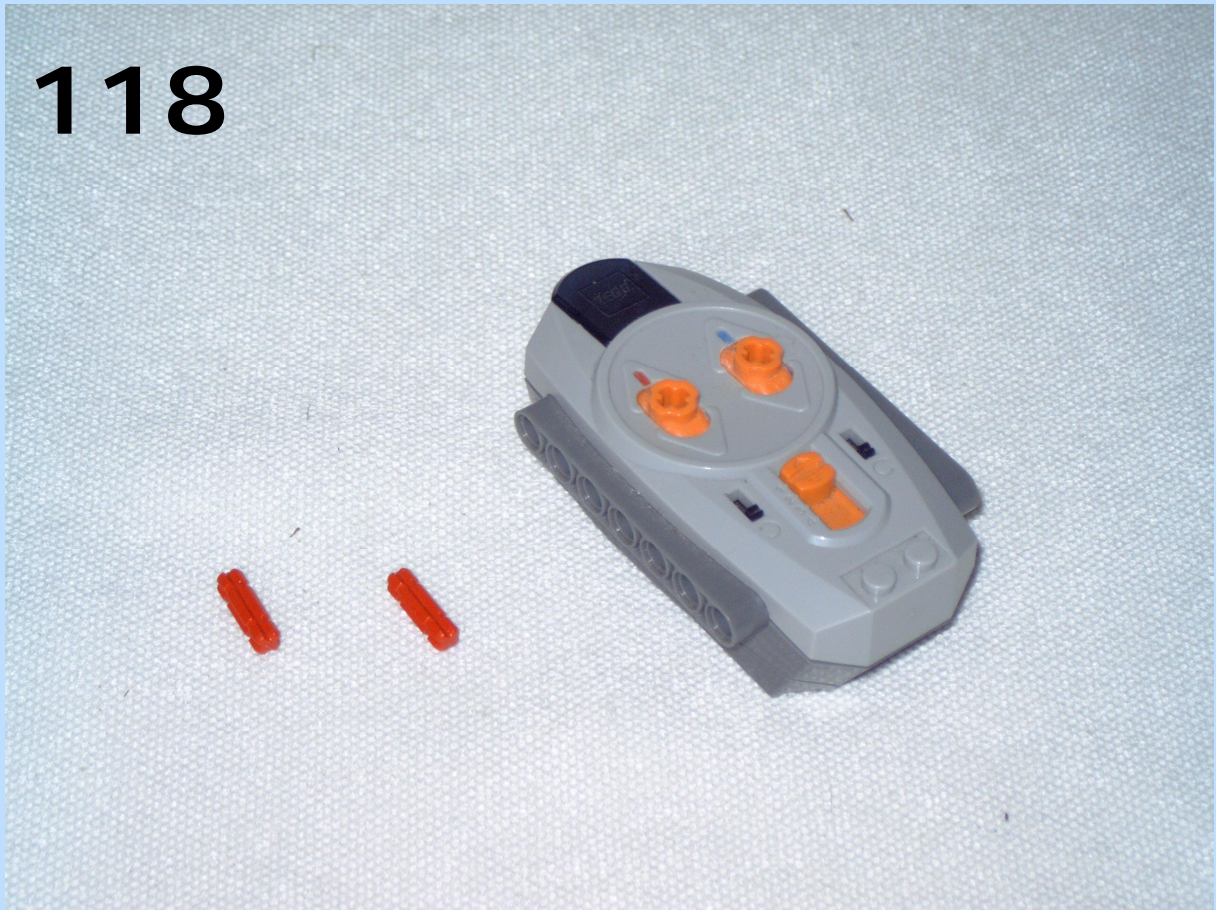

119

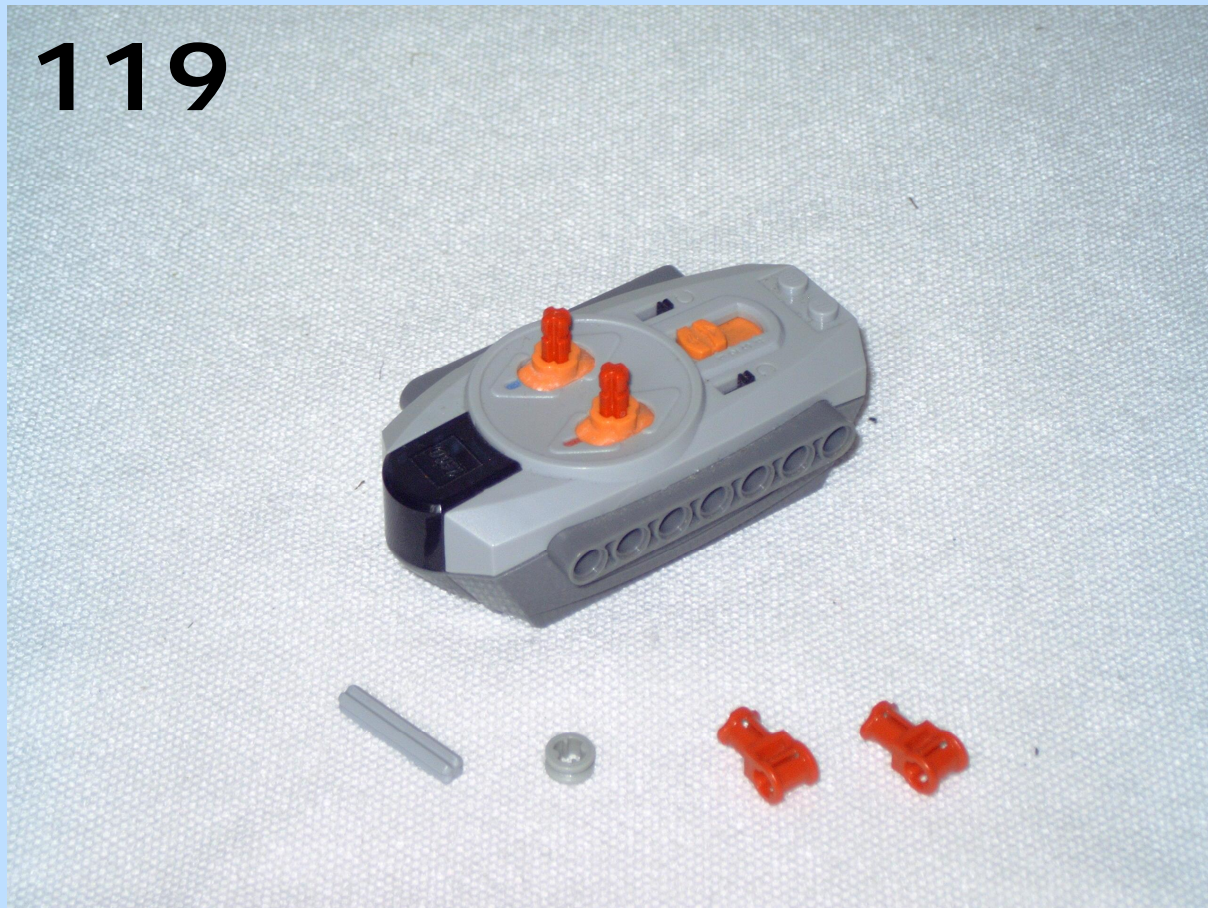

120

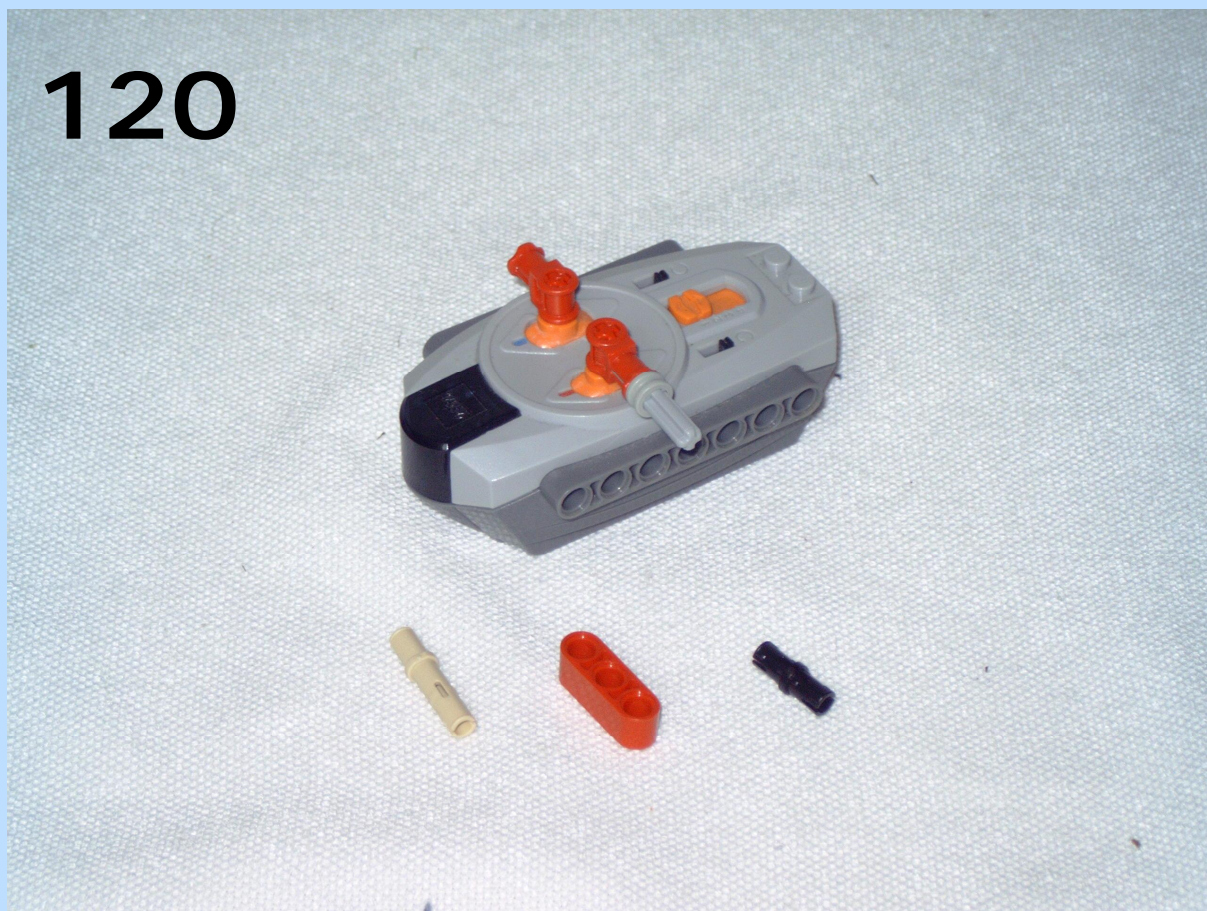

121

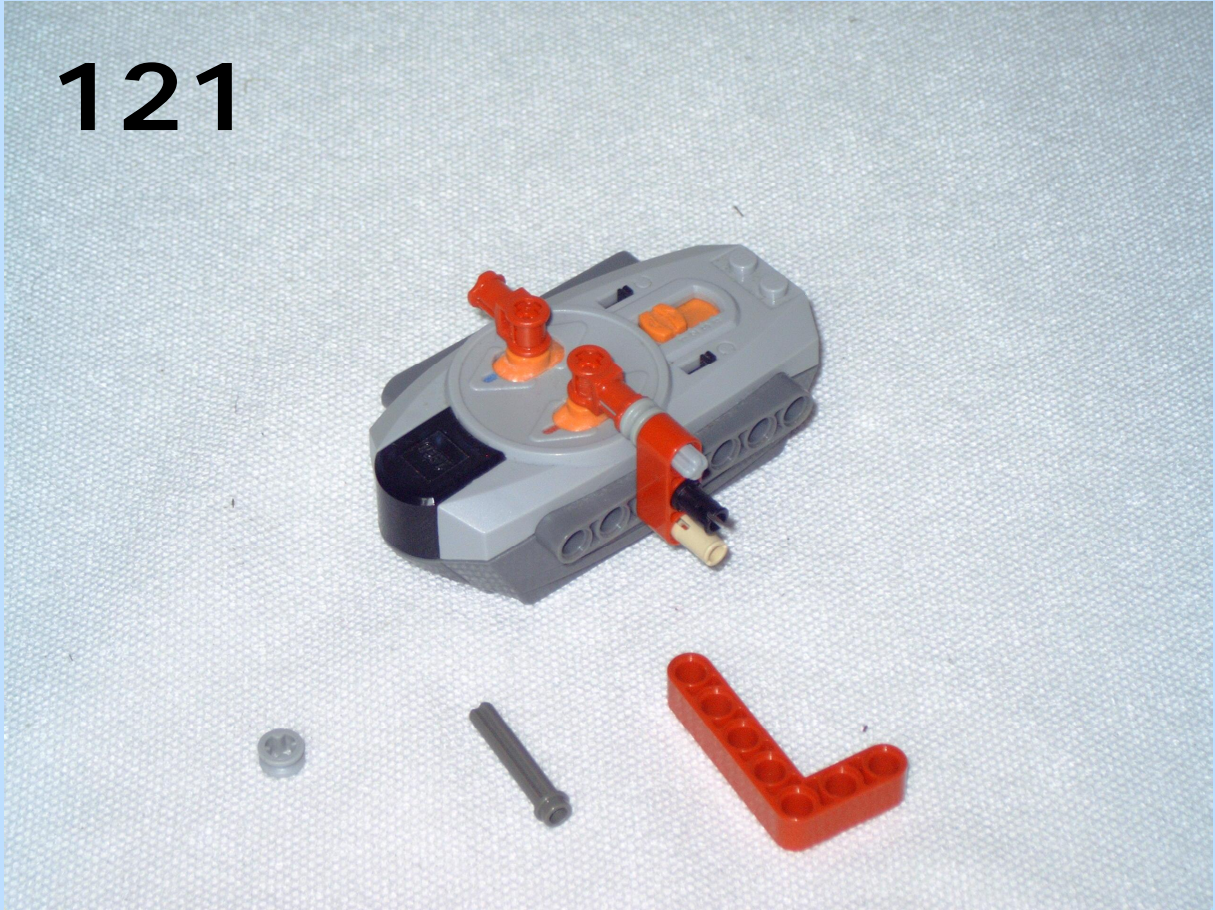

122

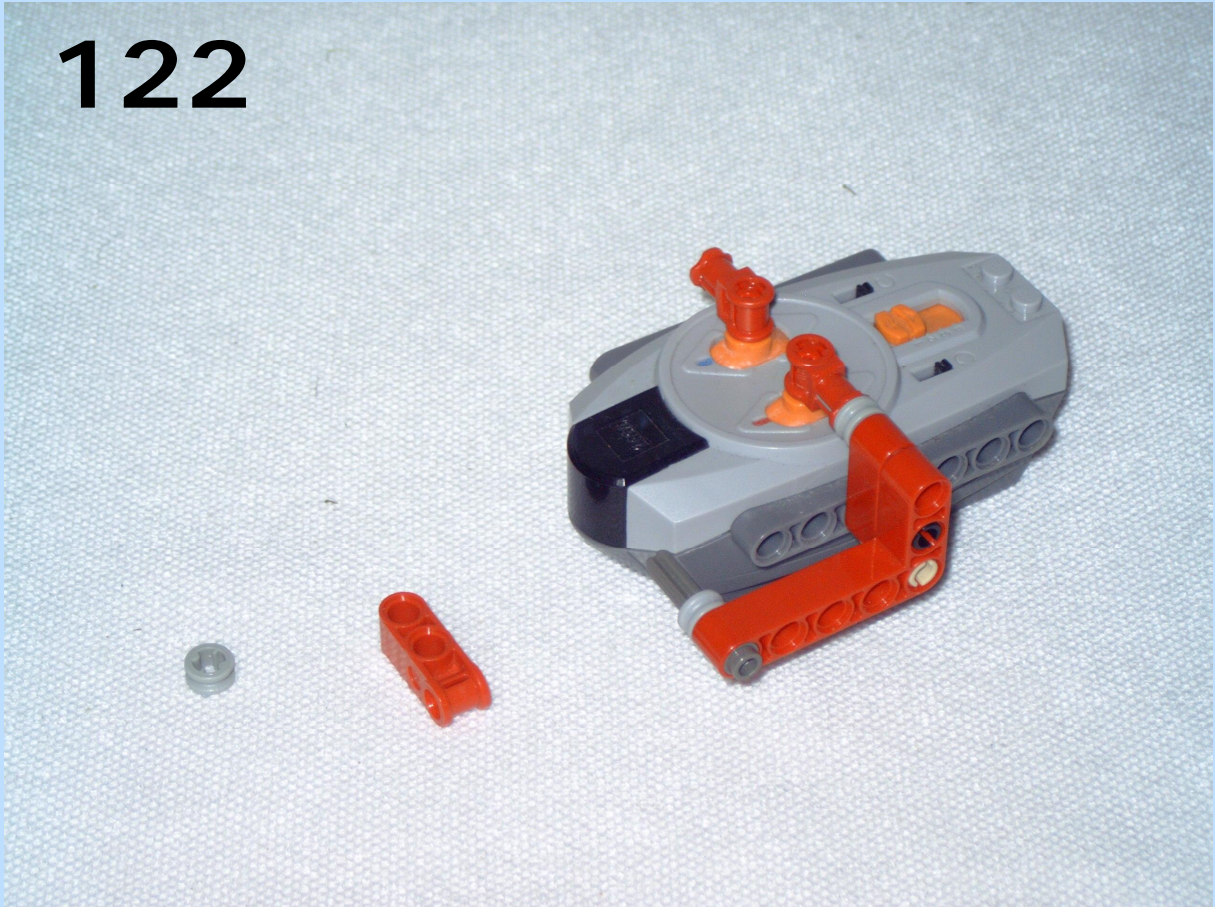

123

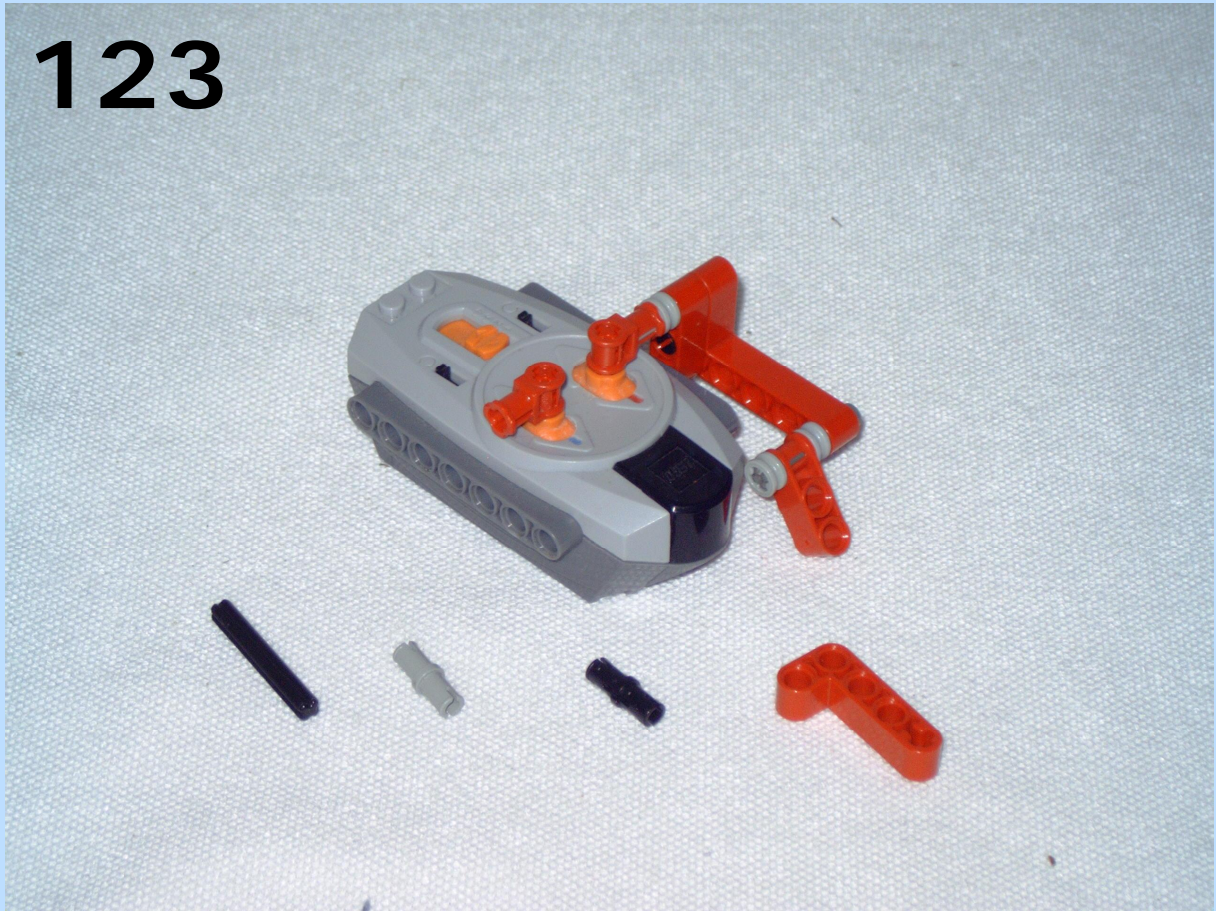

124

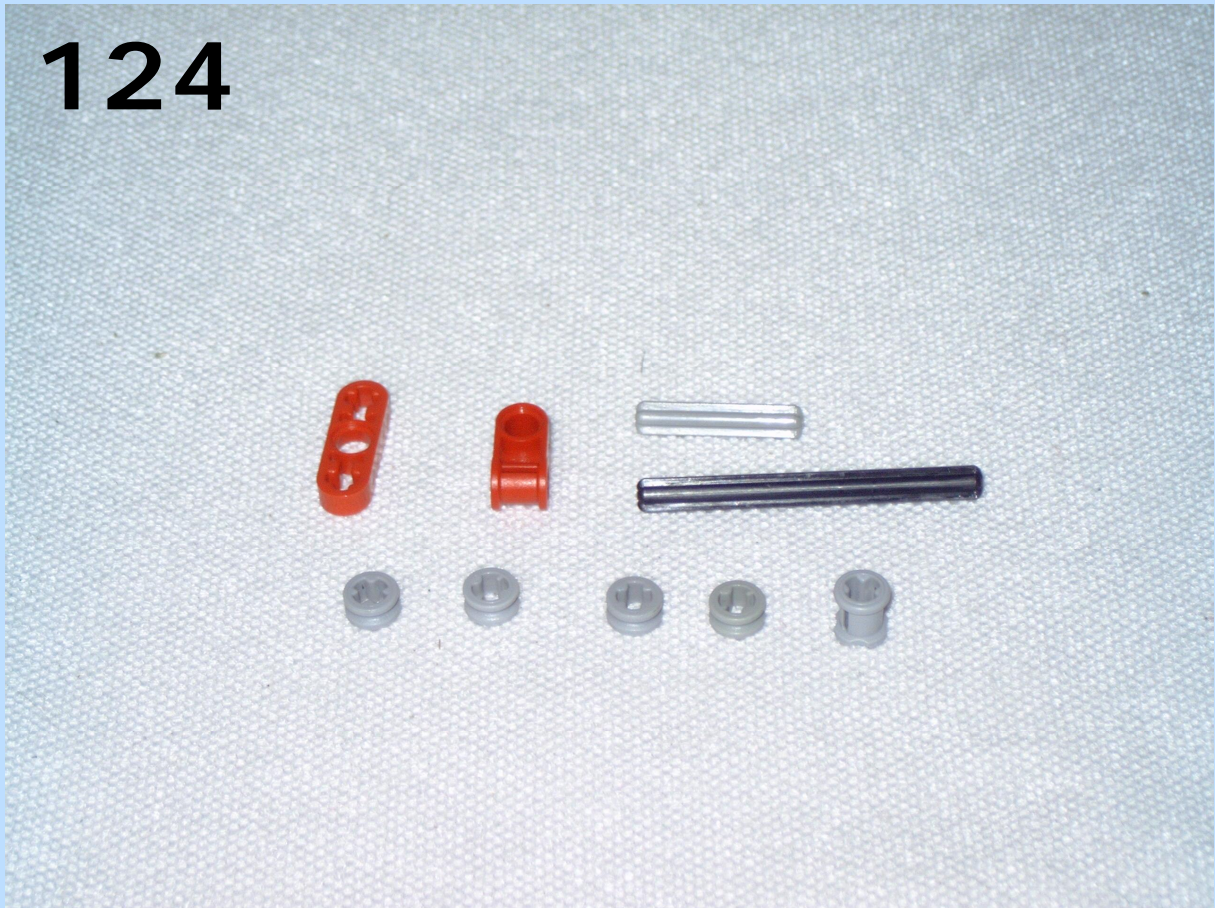

125

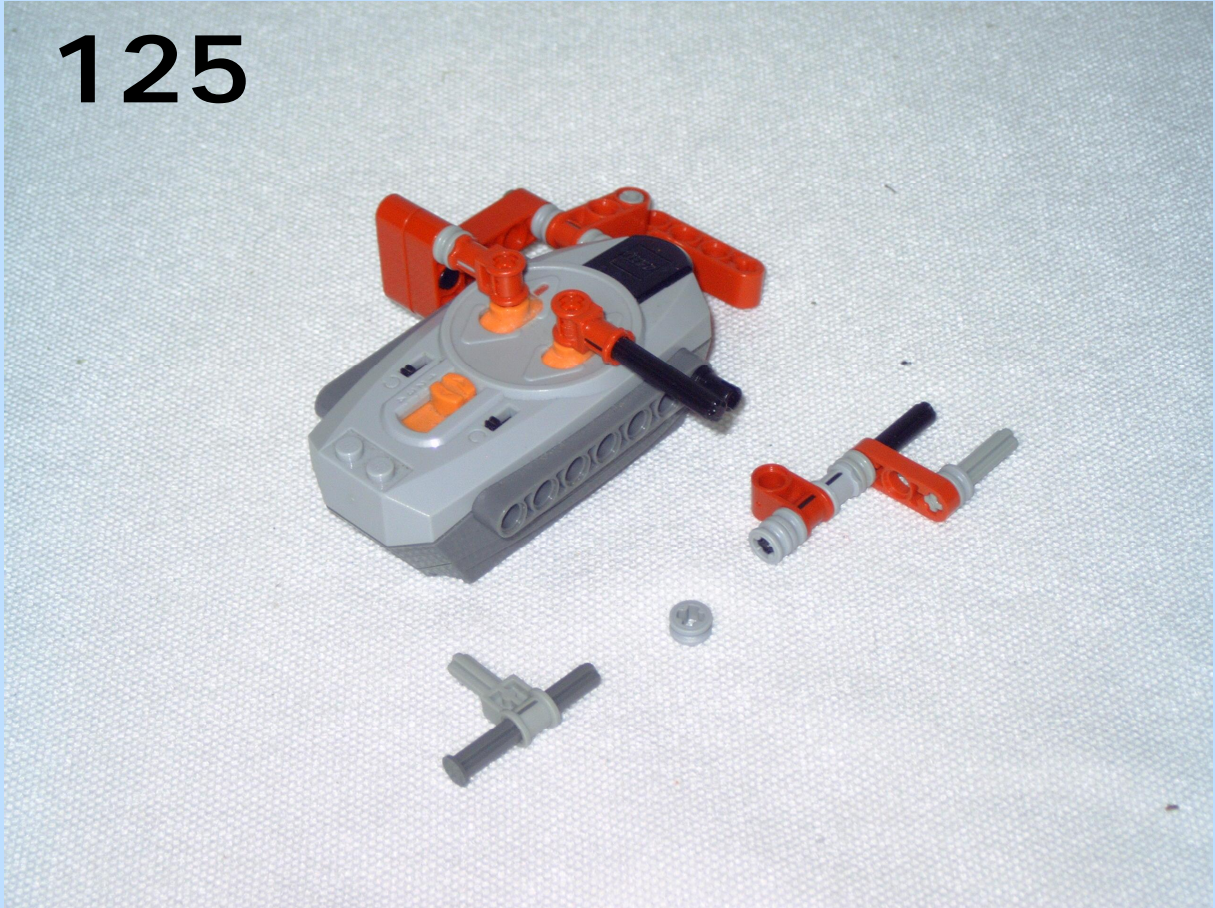

126



127

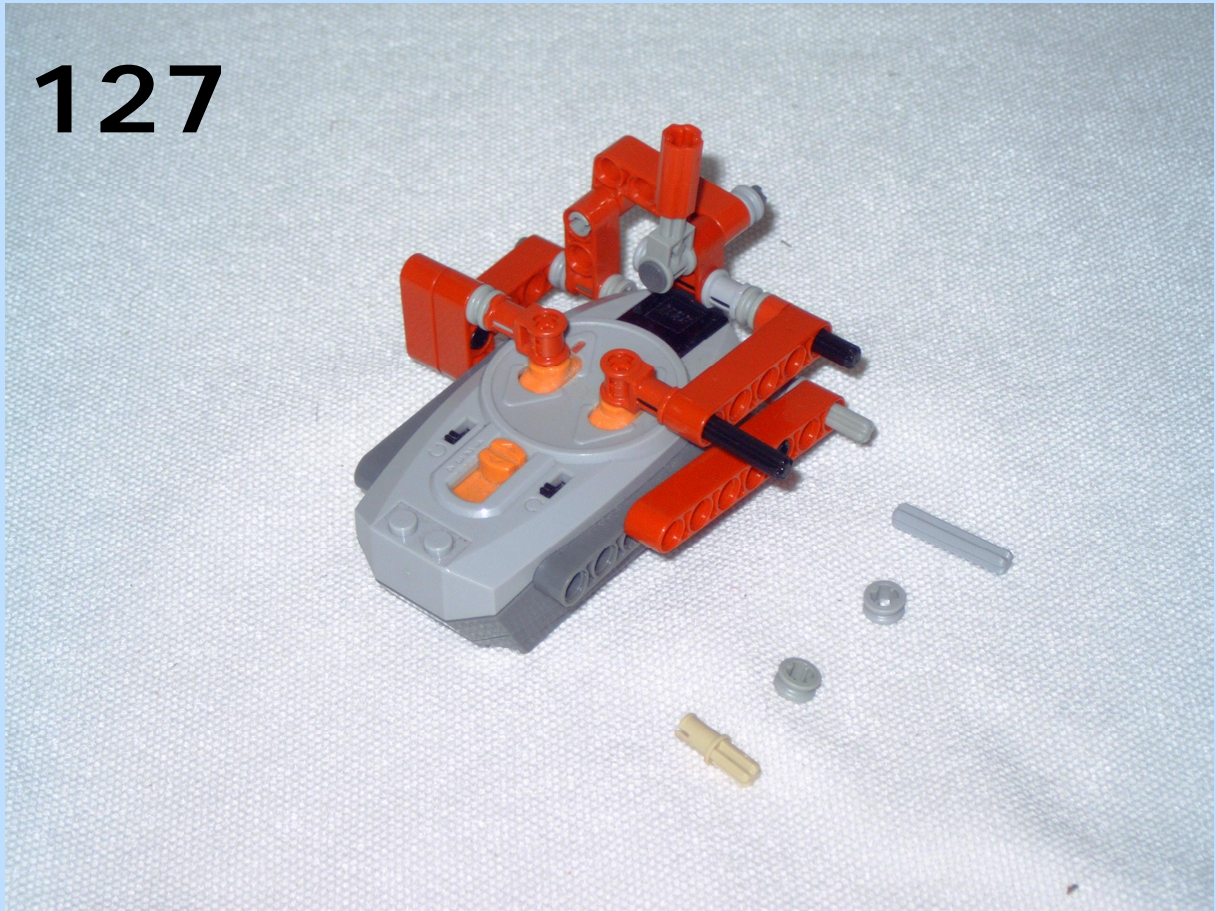

128

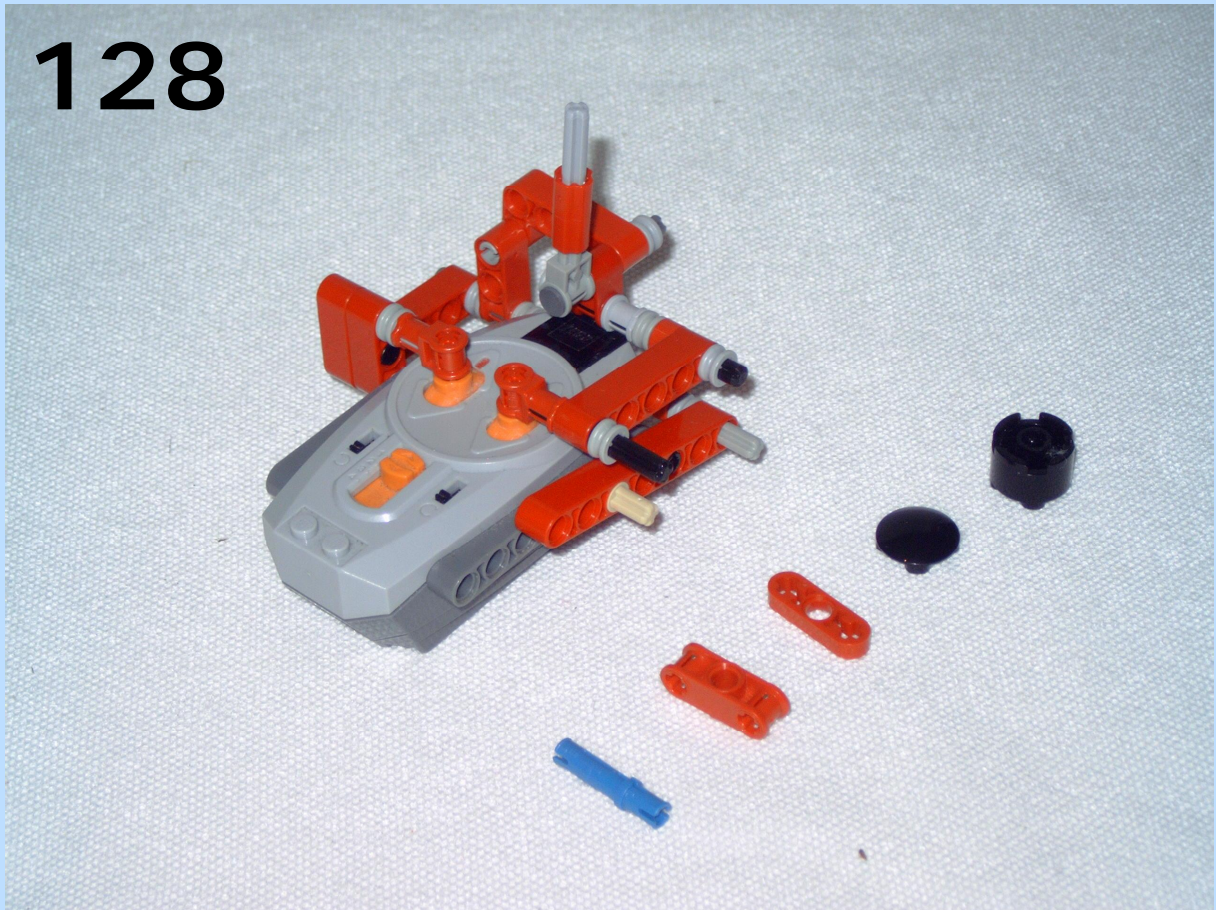

129

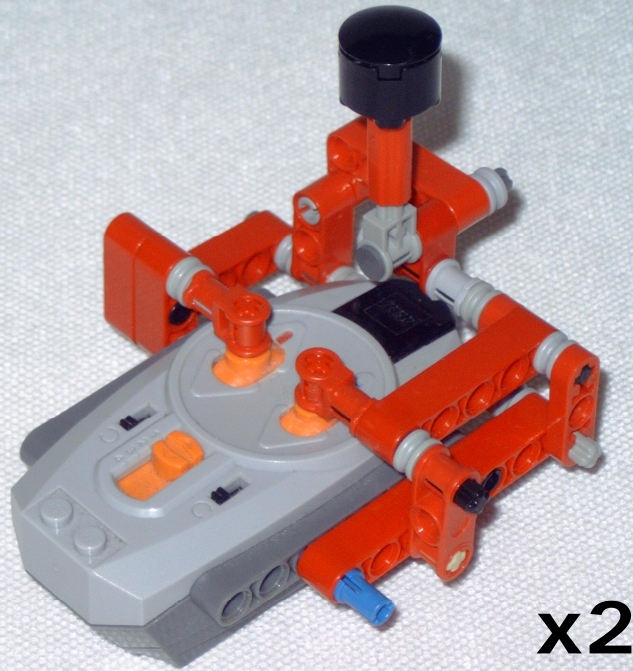

x2

130



131

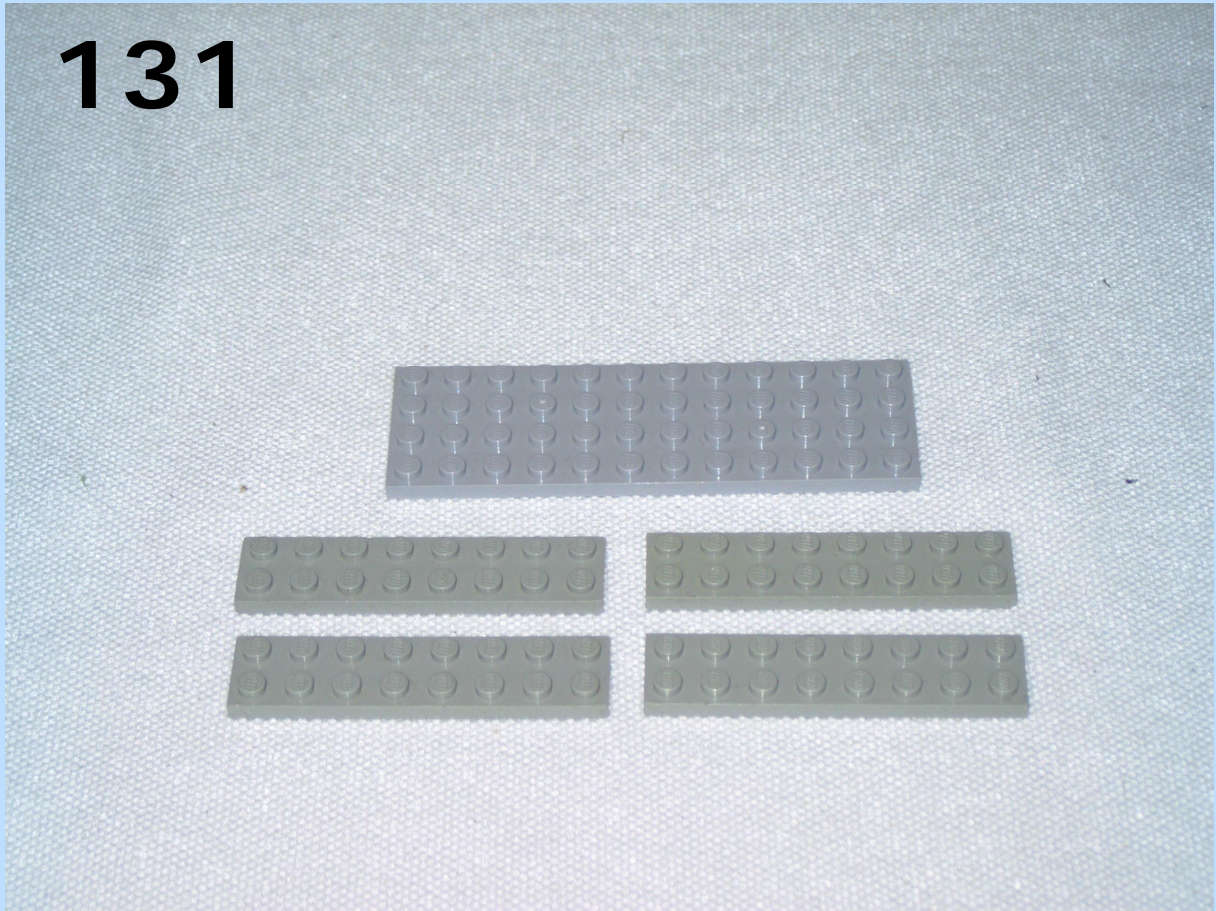

132

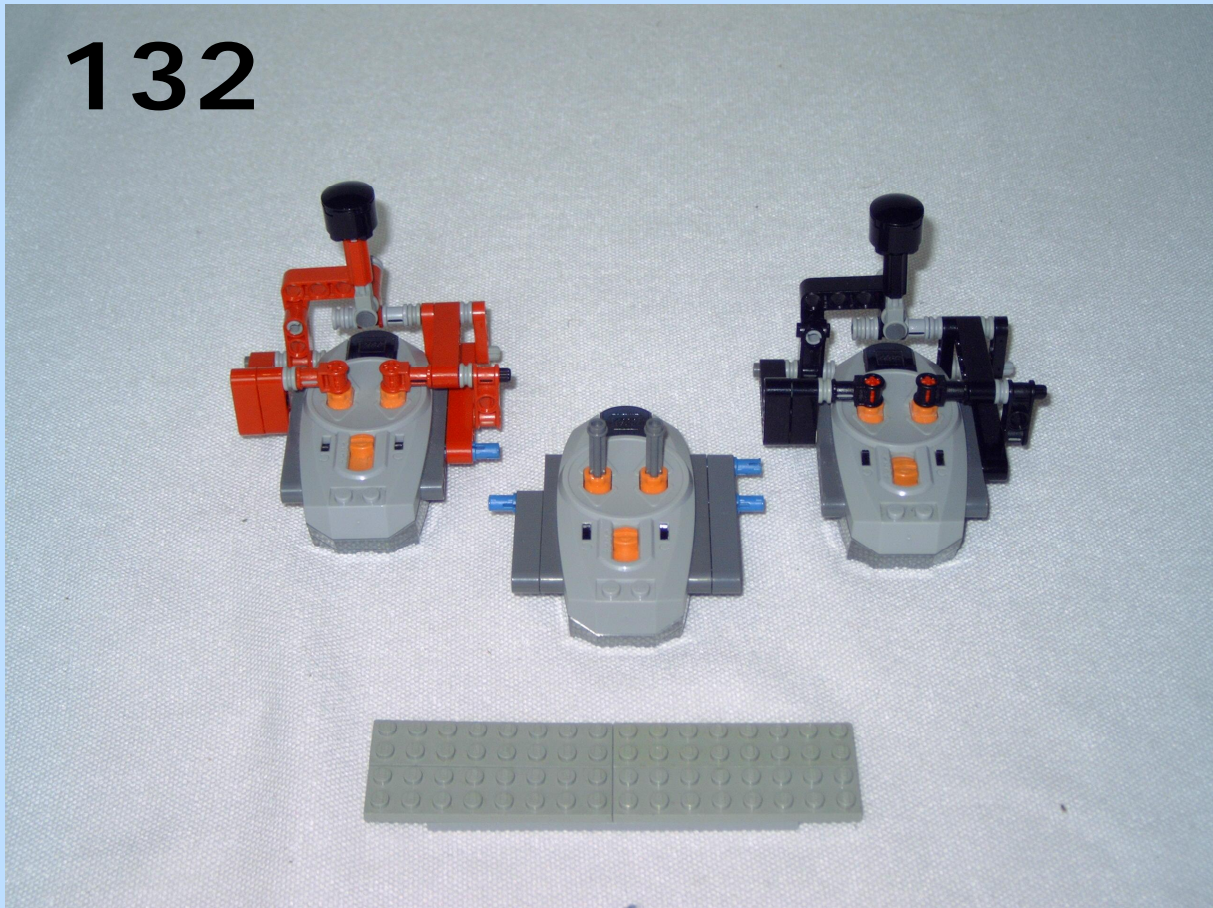

133

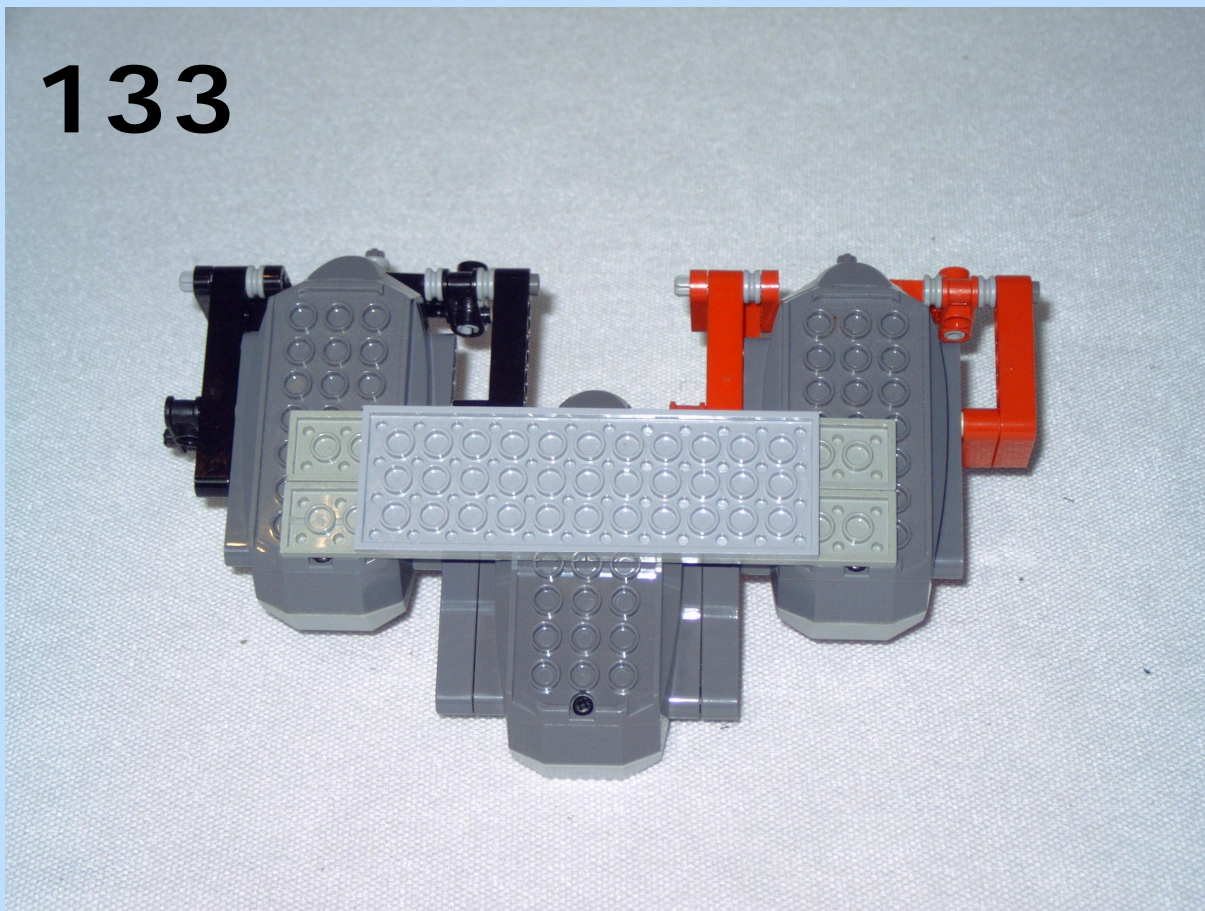

134

