



BATMAN



7784
Book 1





2

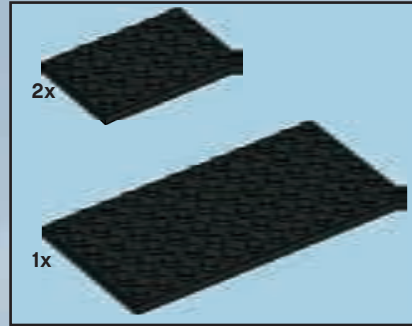

1

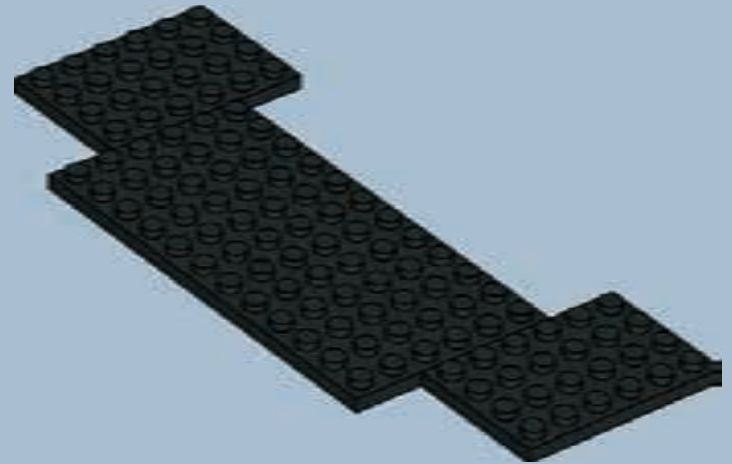
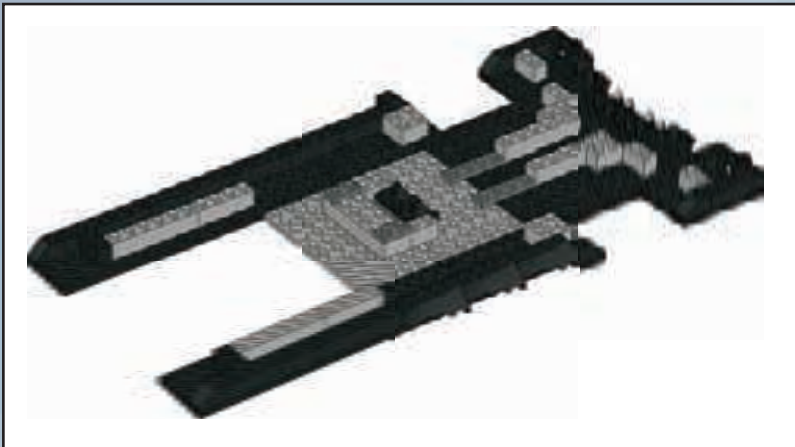



2

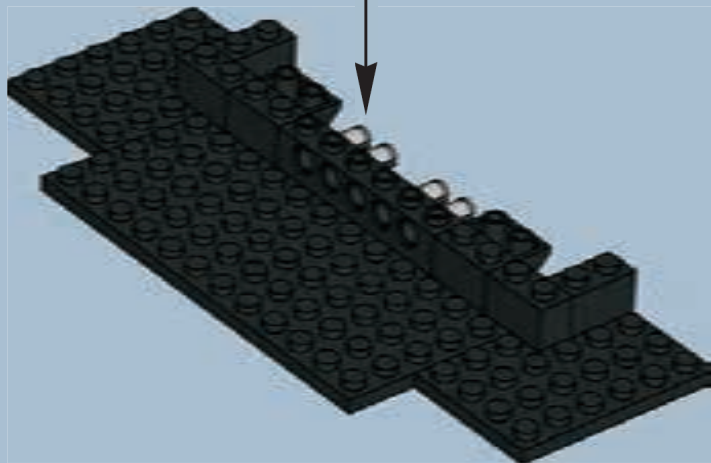
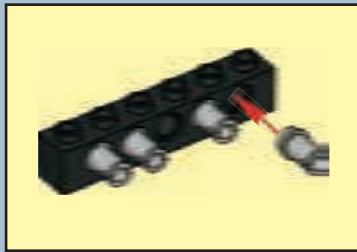

3

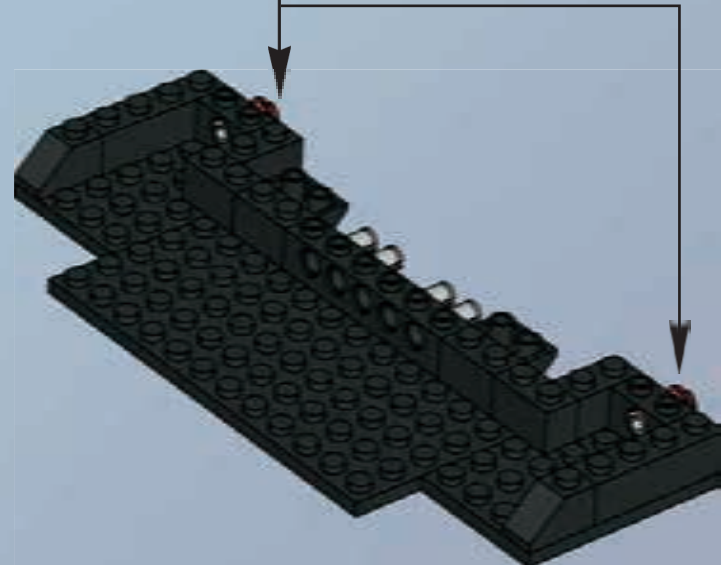
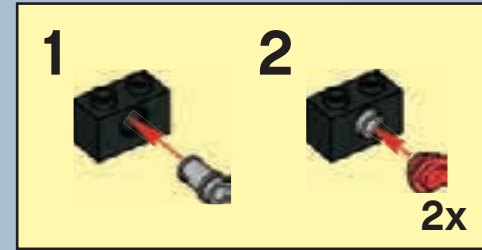

4

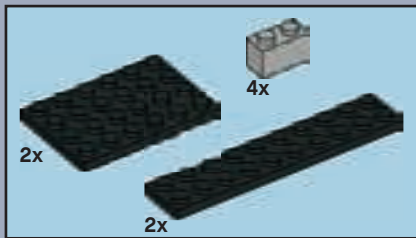

4

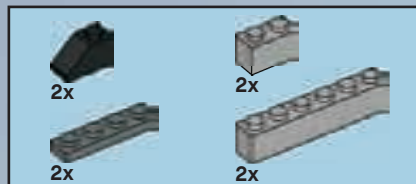
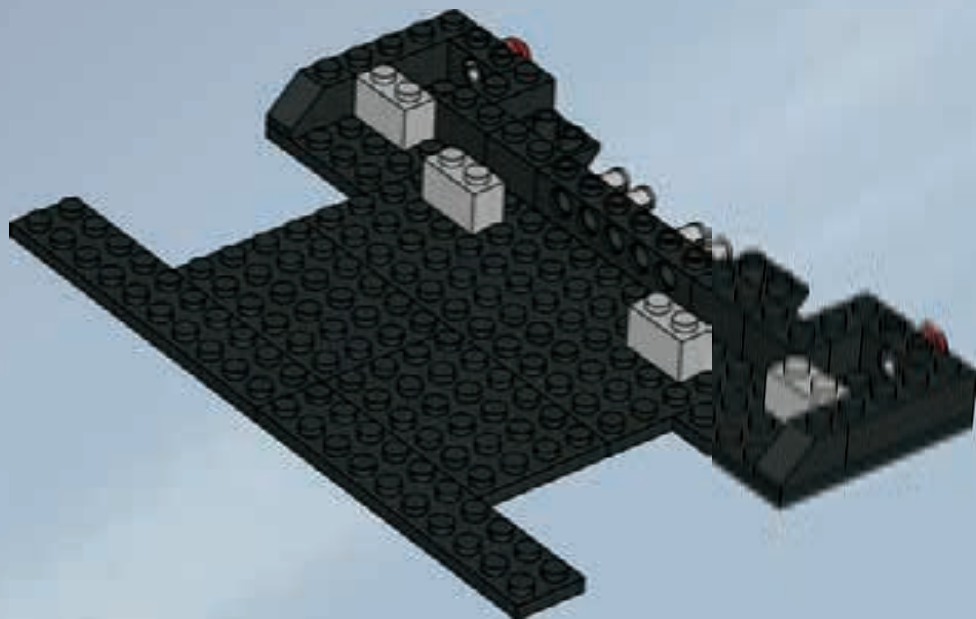

5

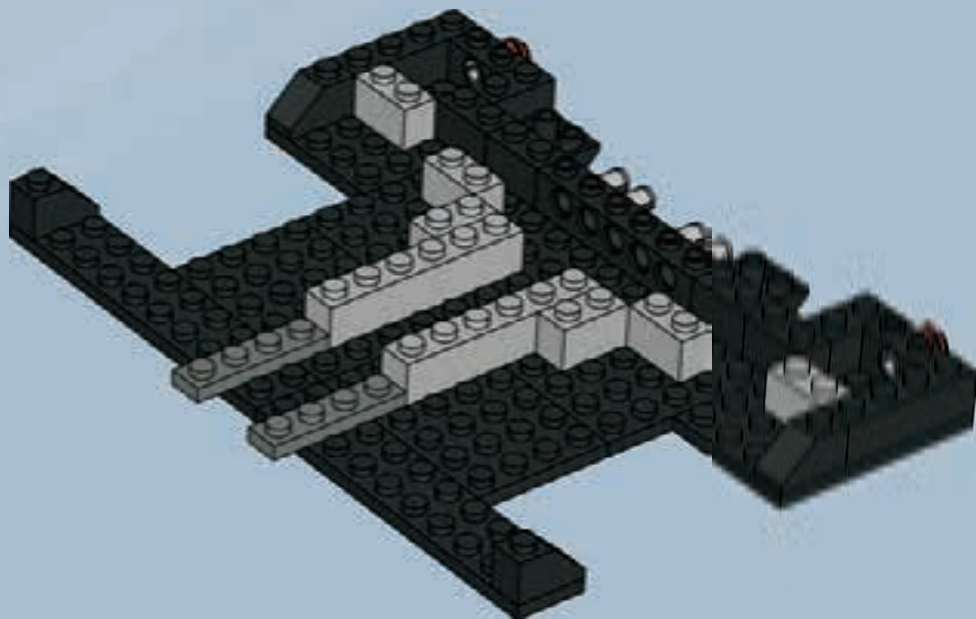

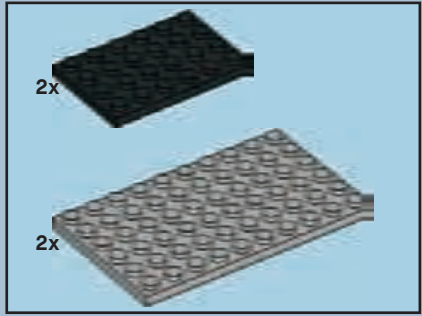

6

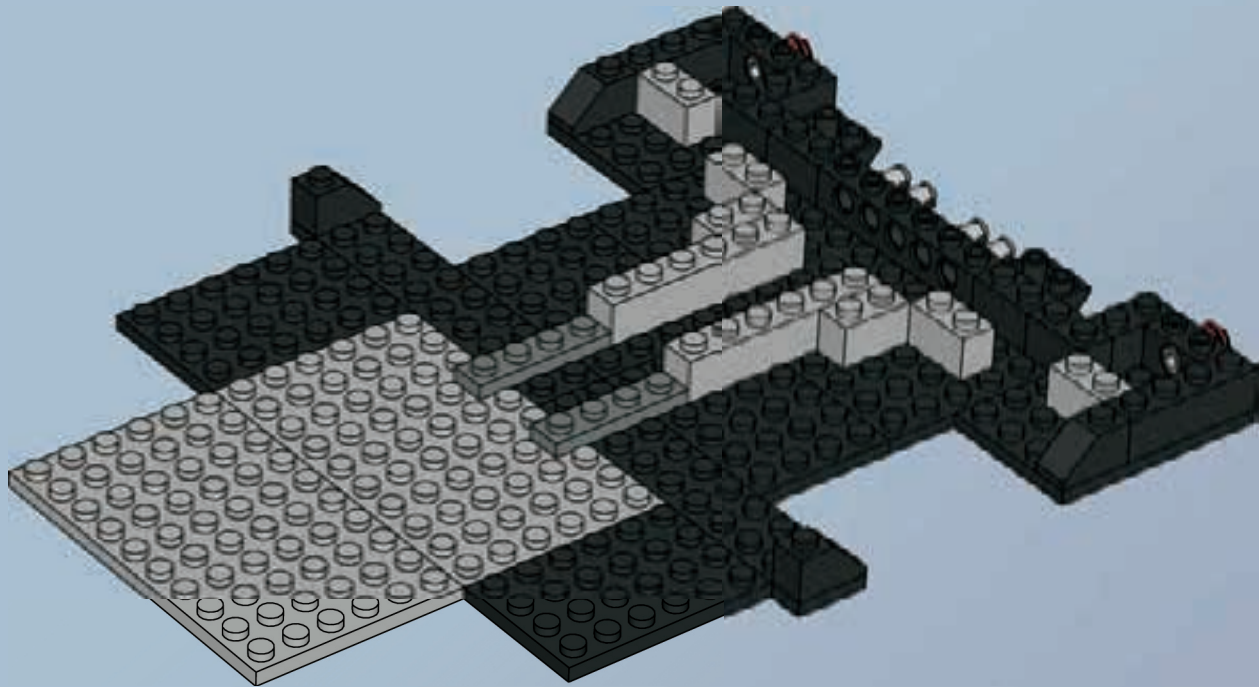

9

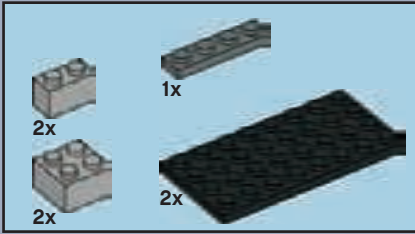

7

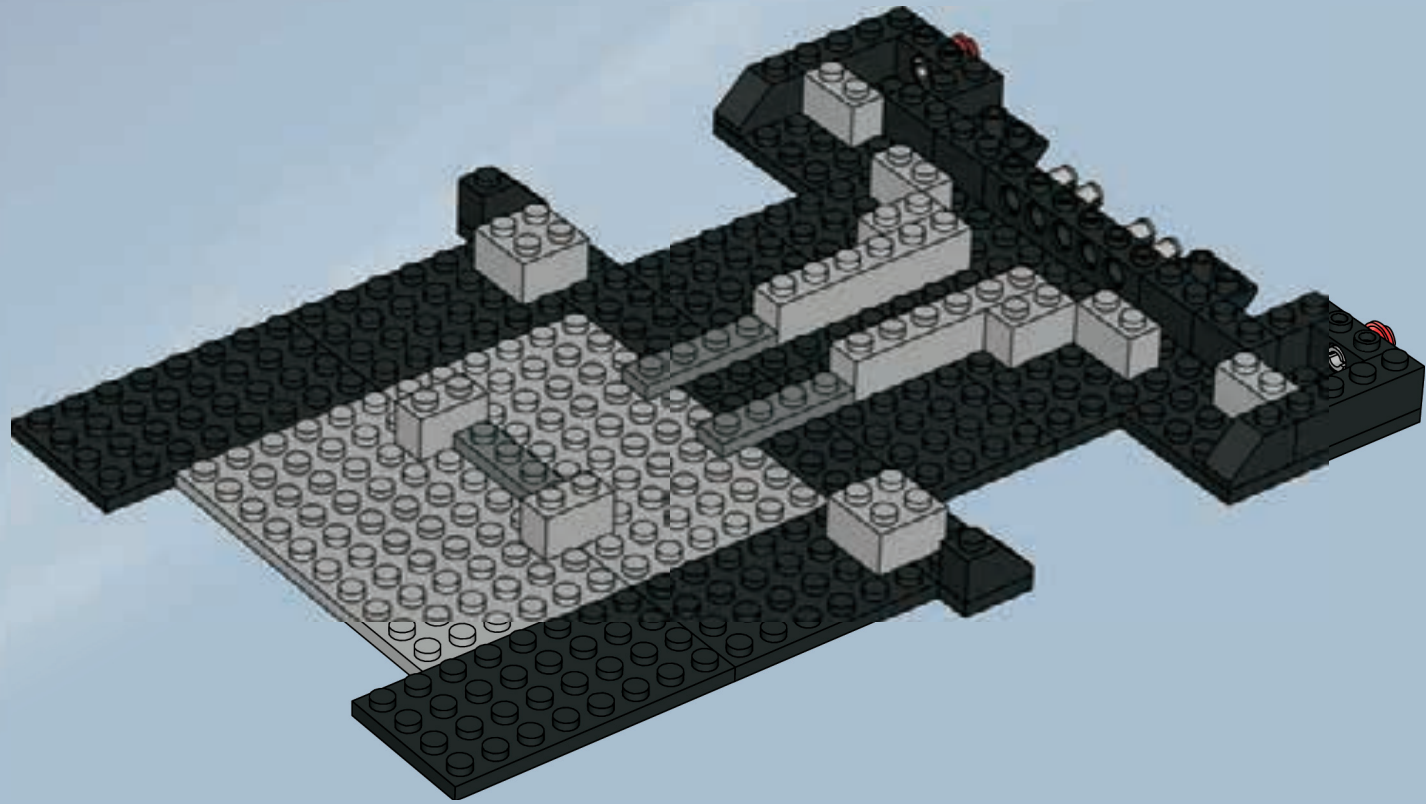

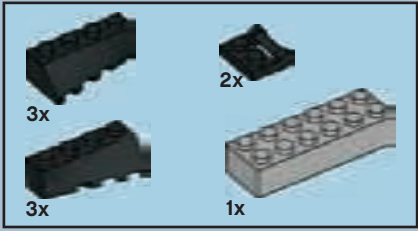

8

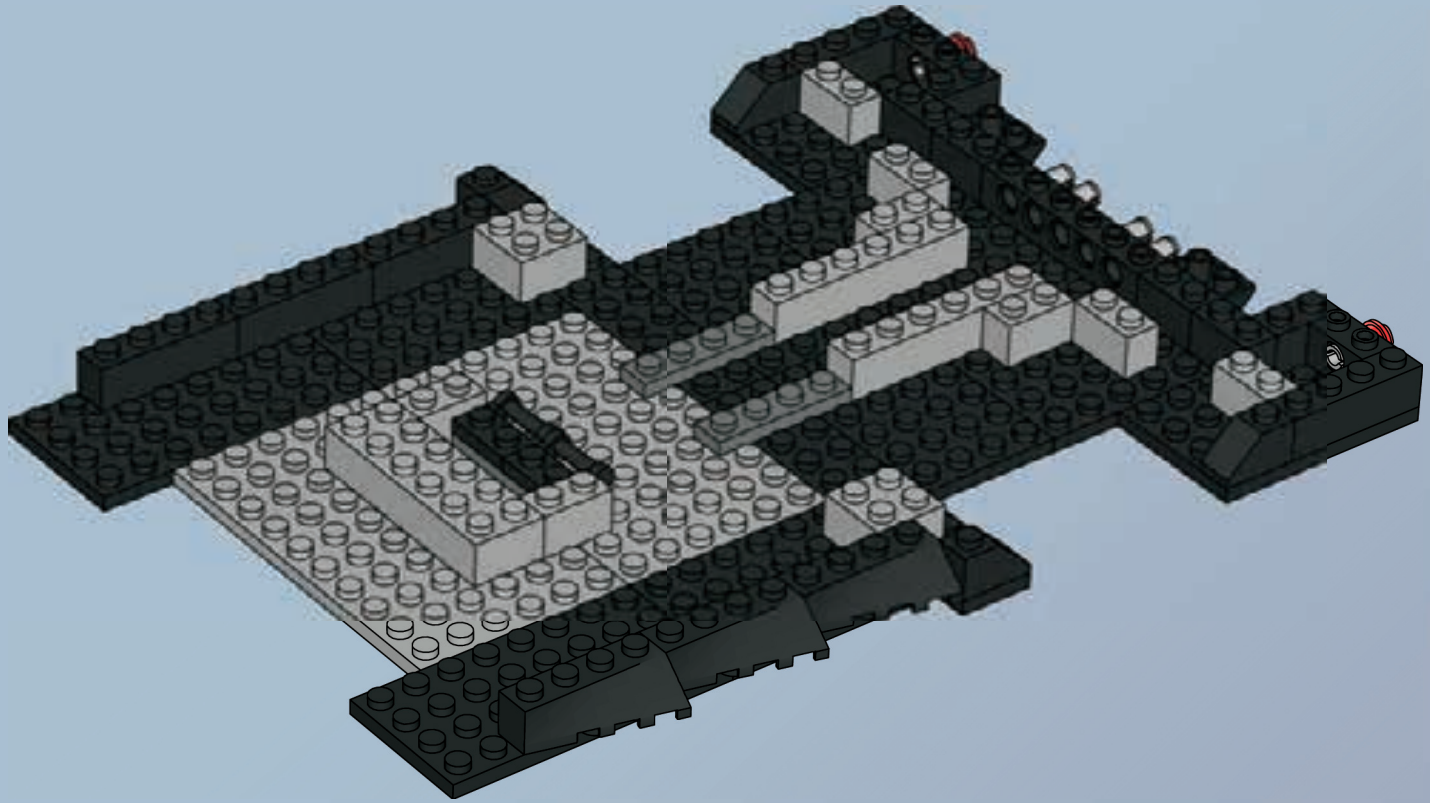

8



9

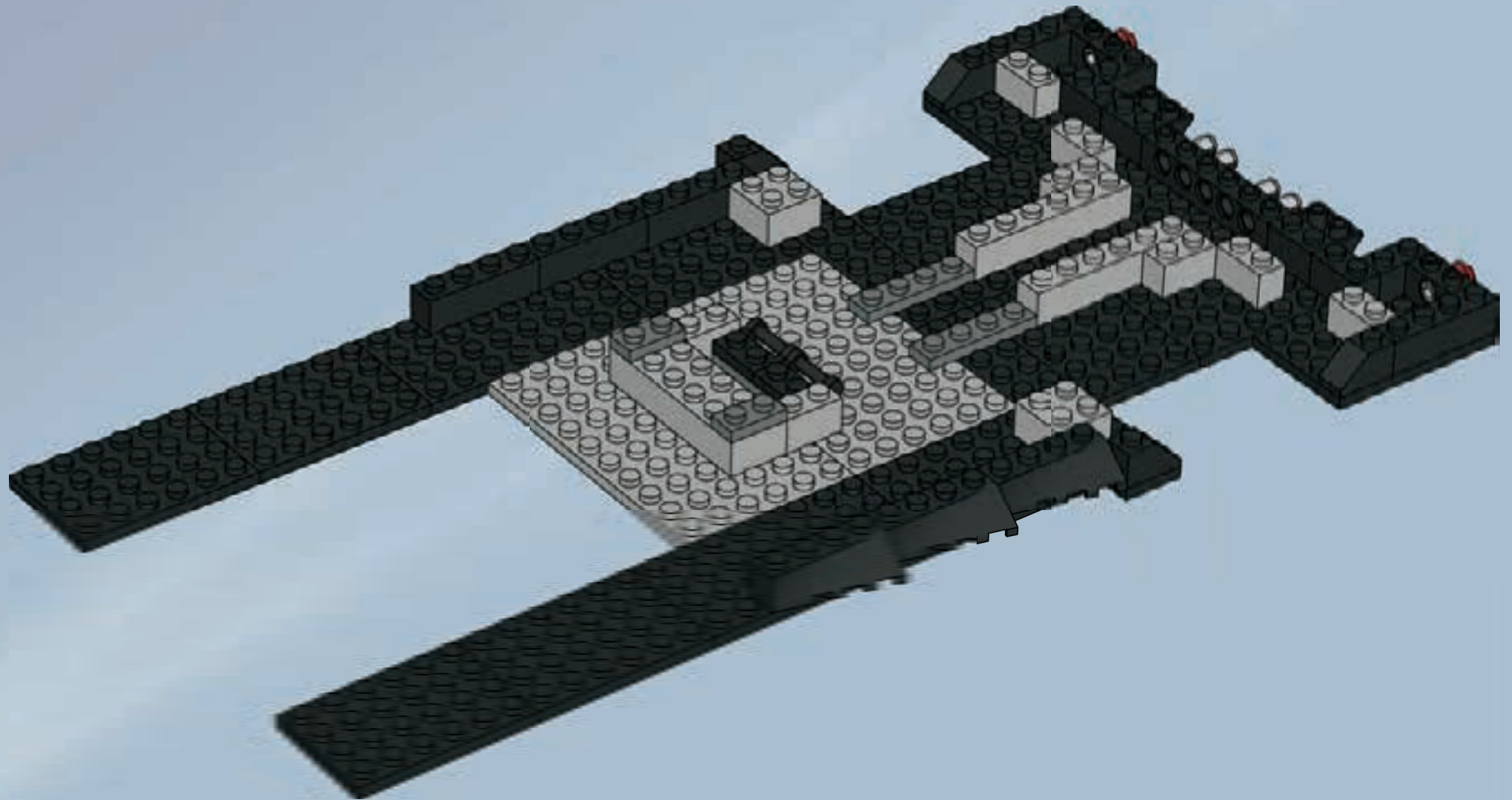

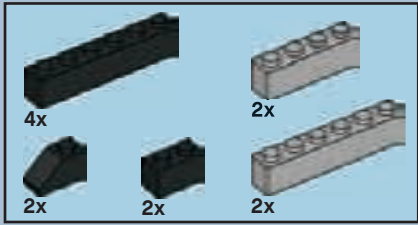

10

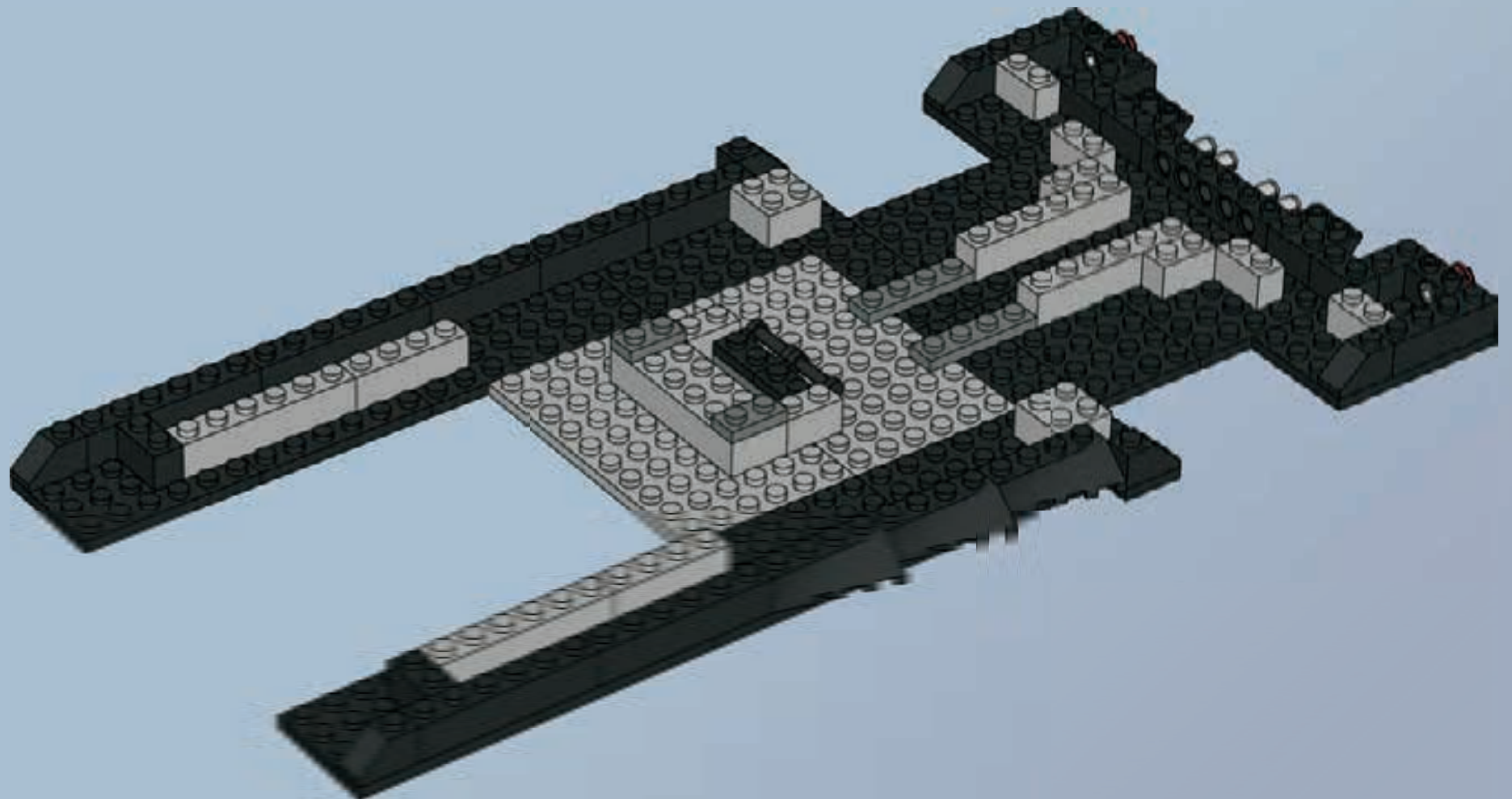

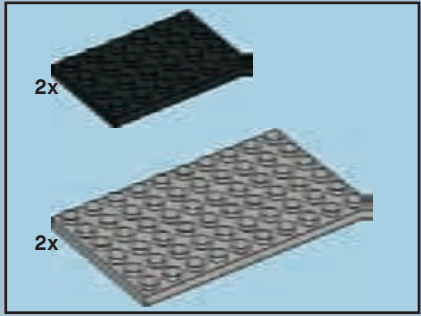

6

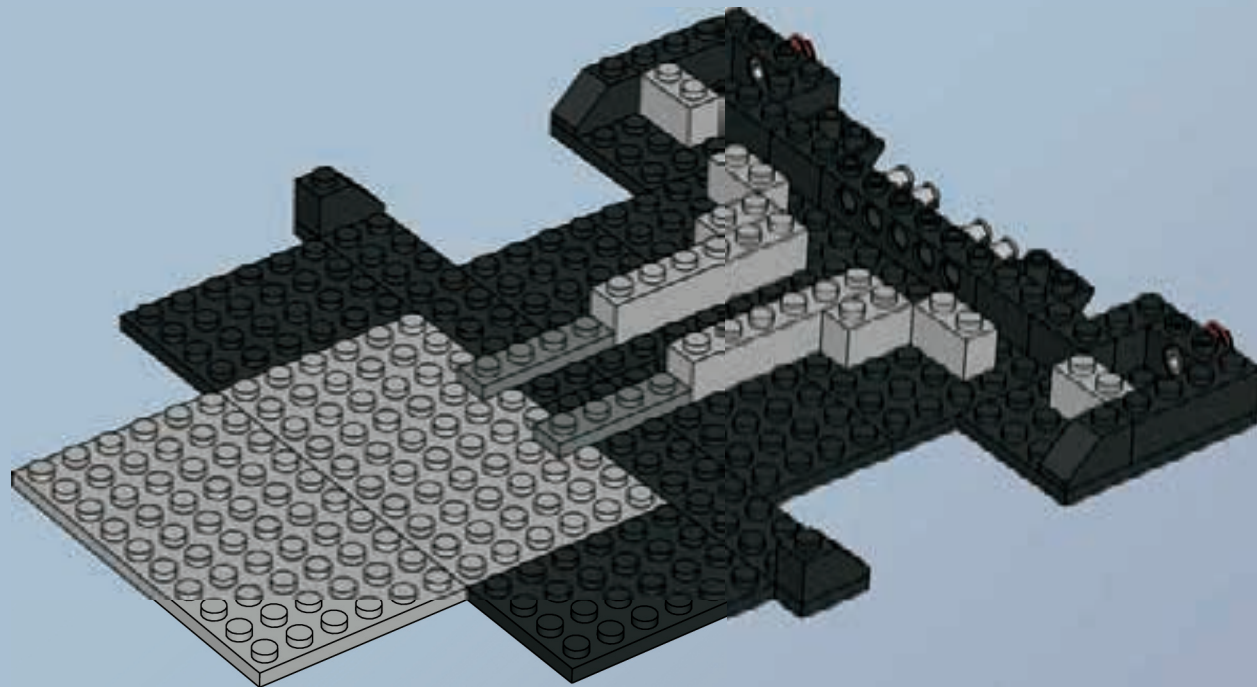

9

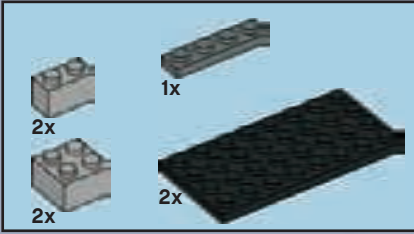

7

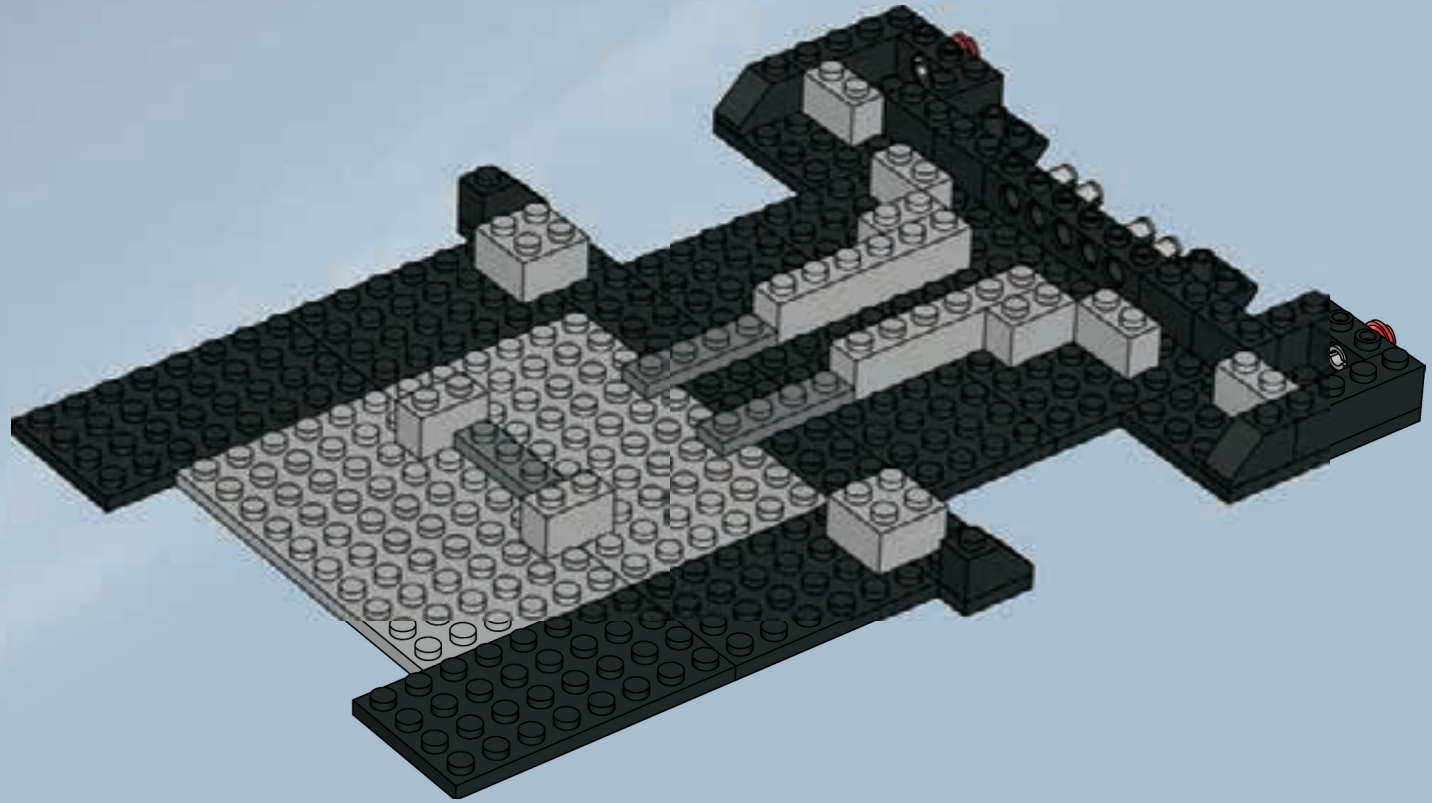

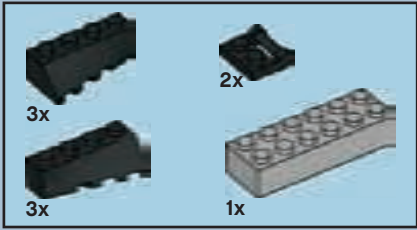

8

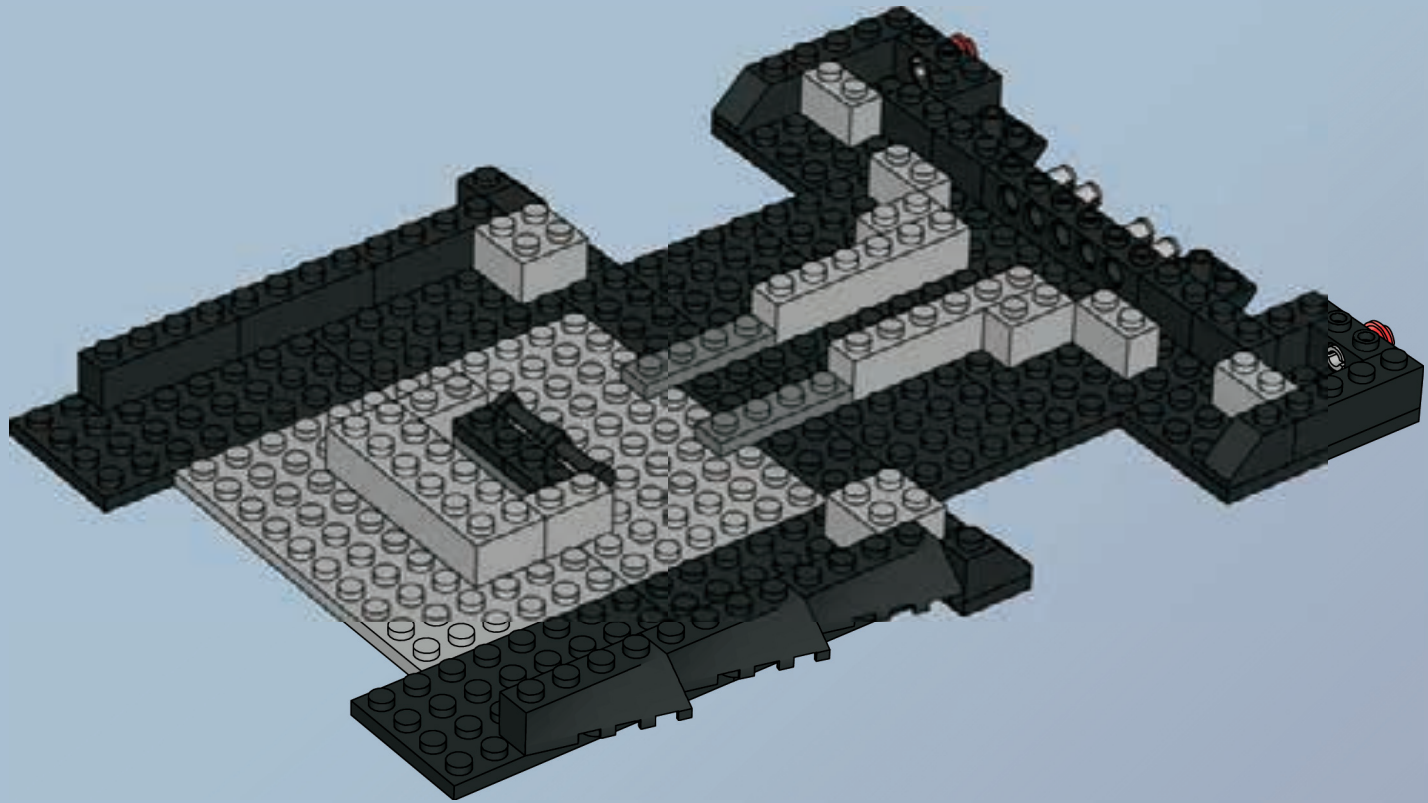

8

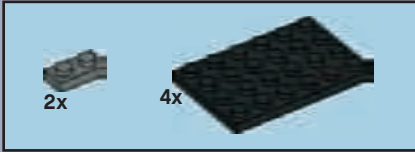

9

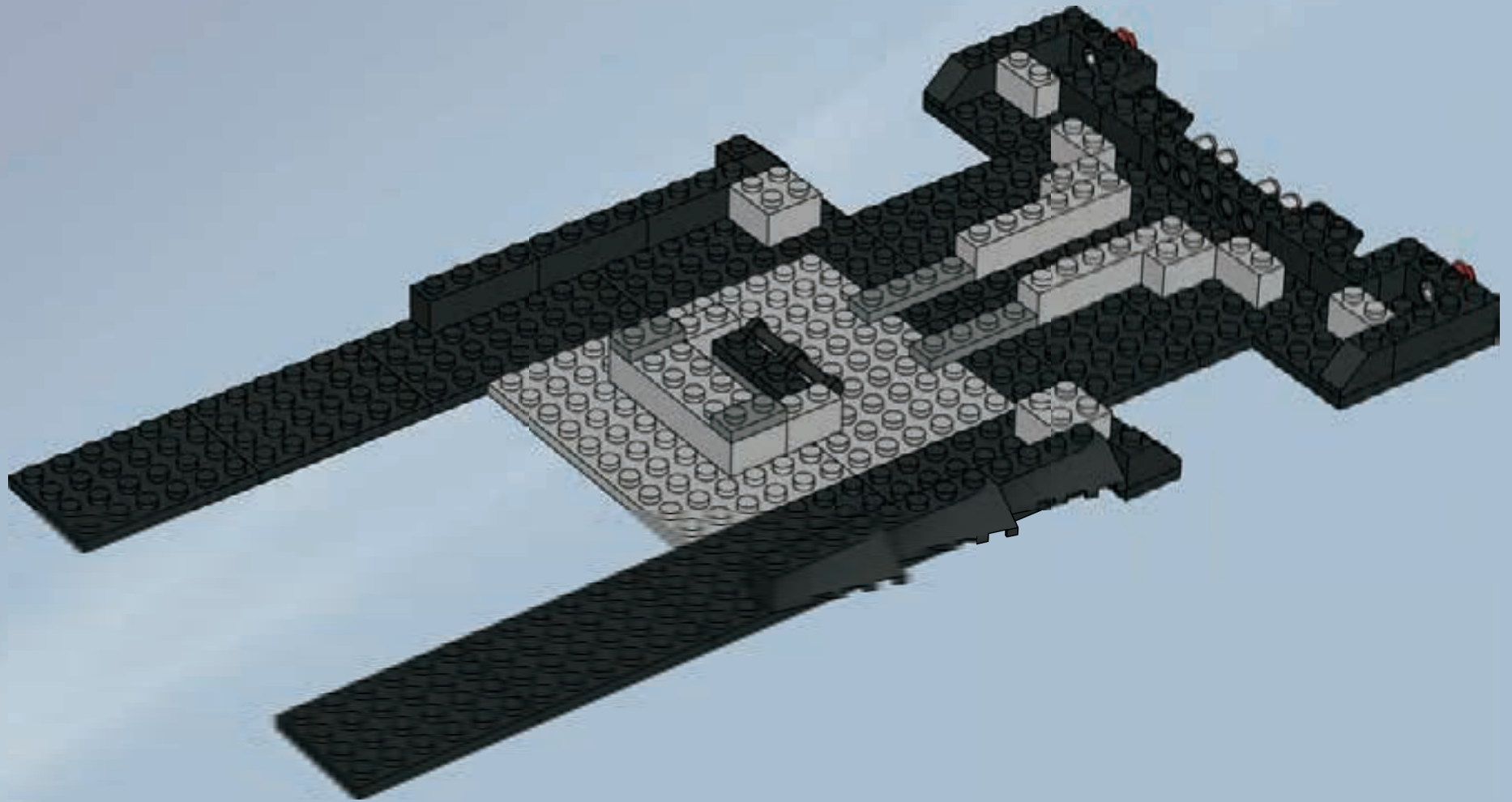

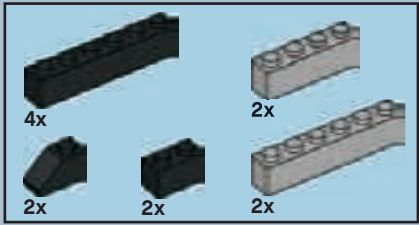

10

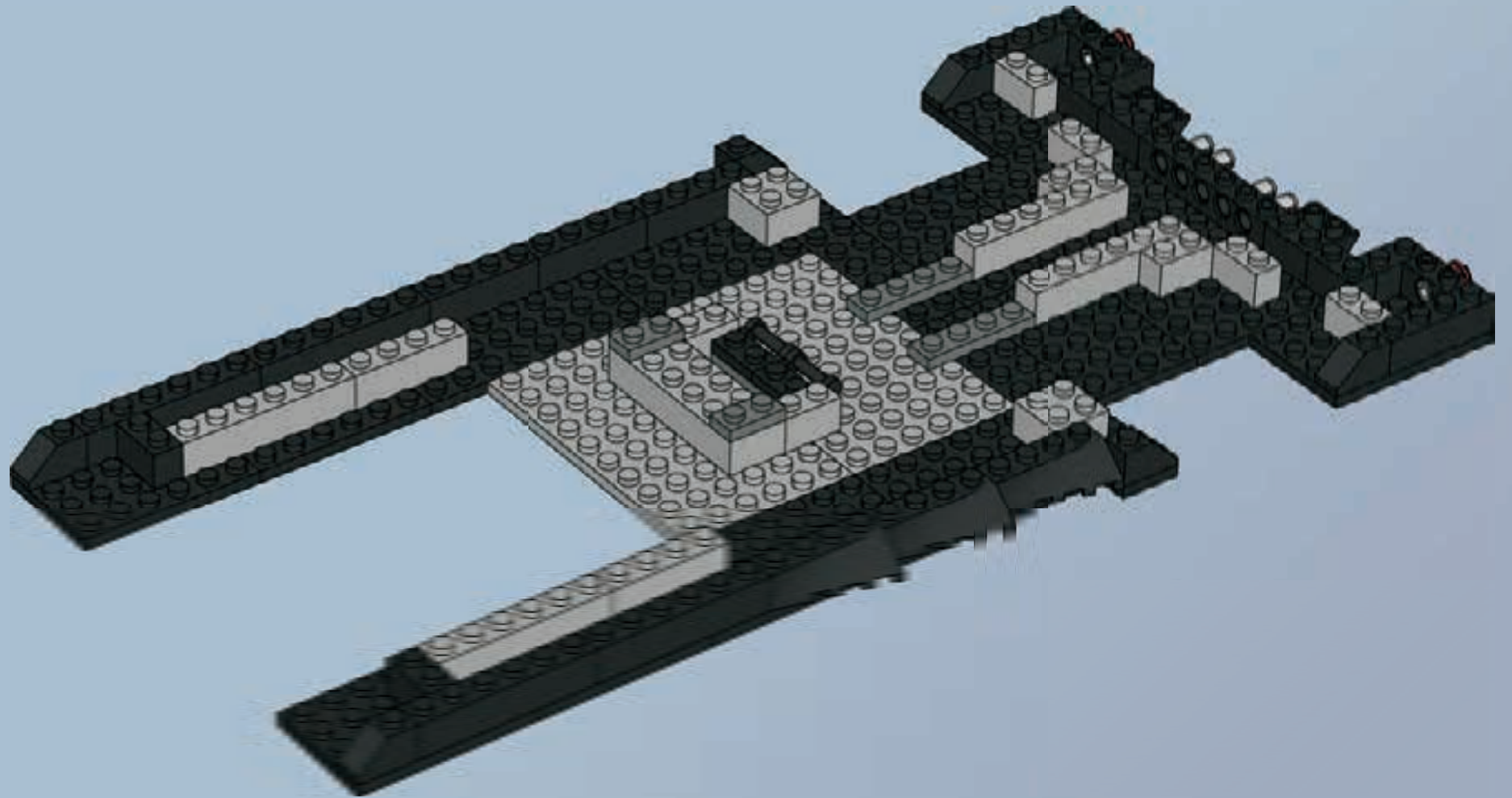

10

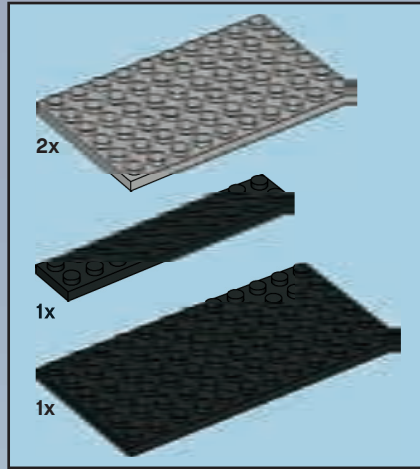
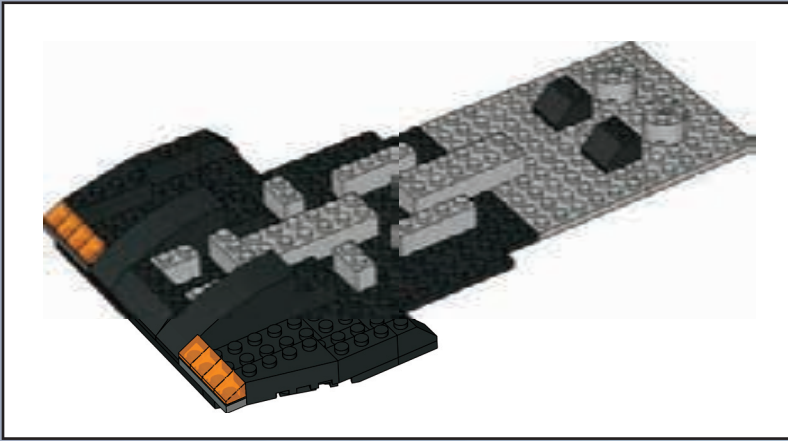

1

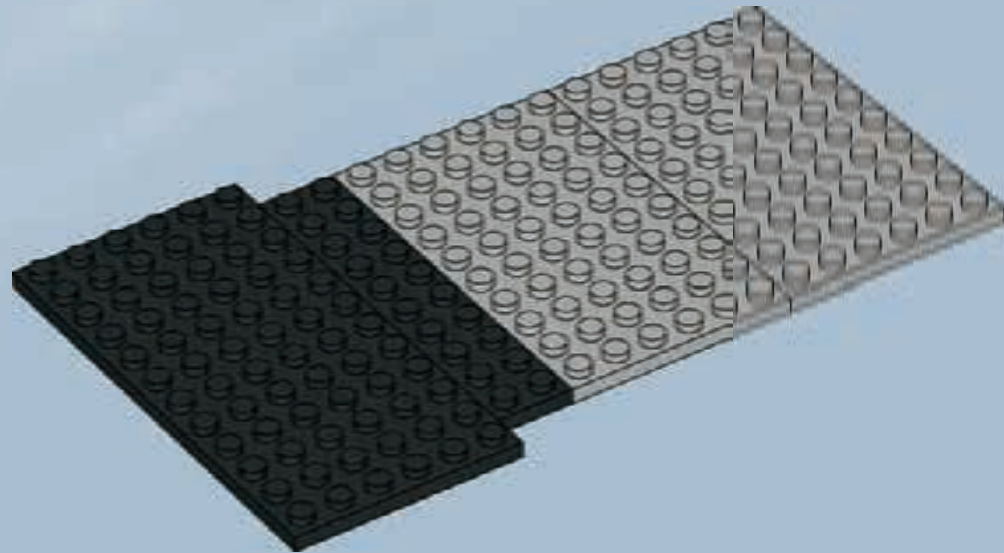

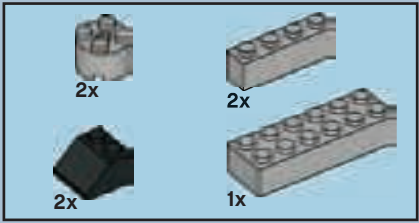

2

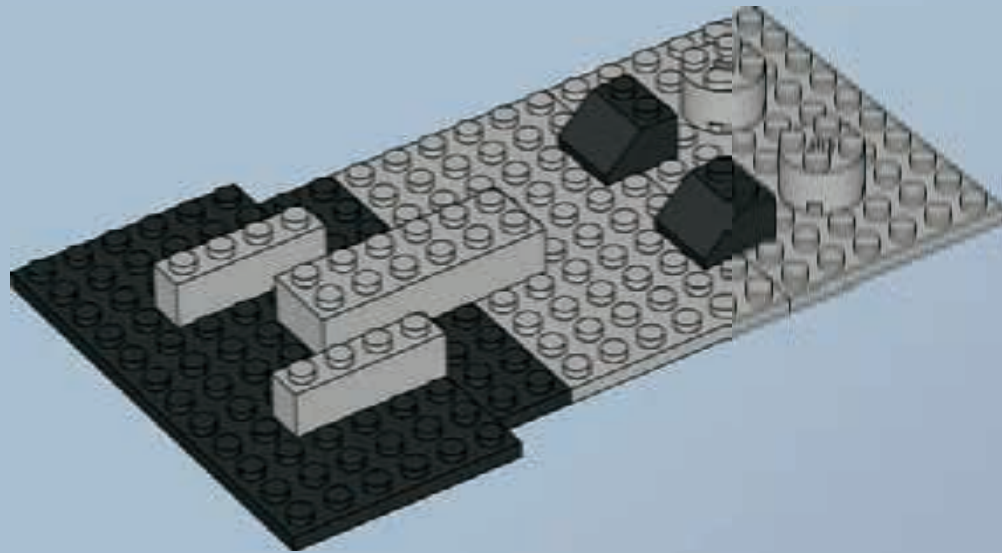

12



3

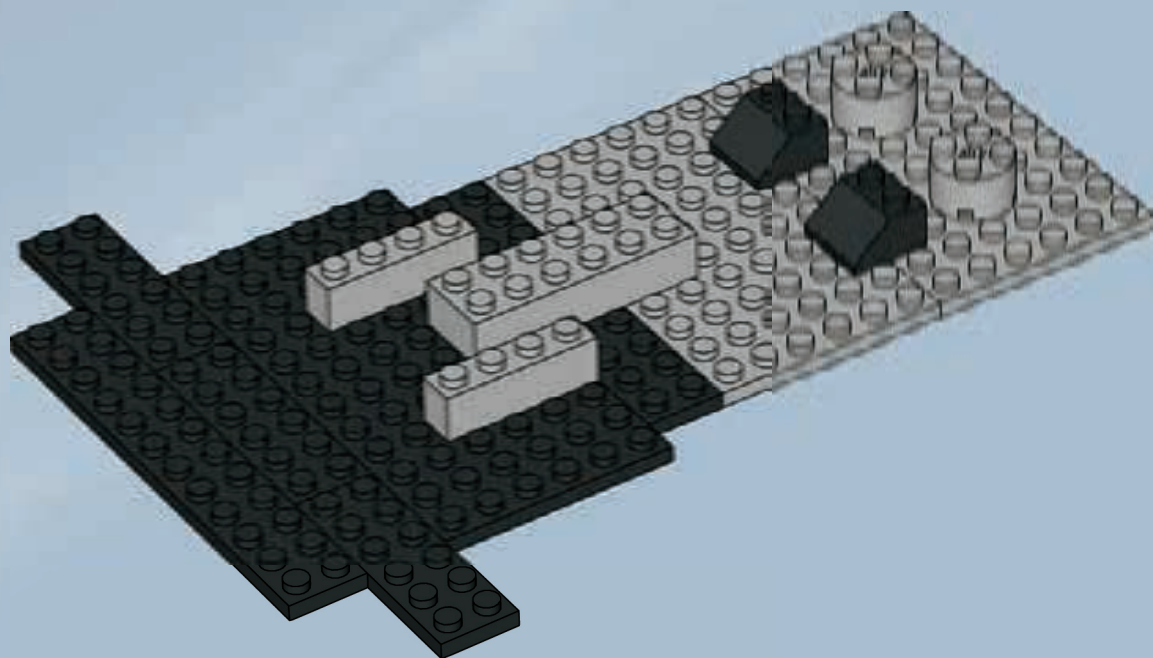

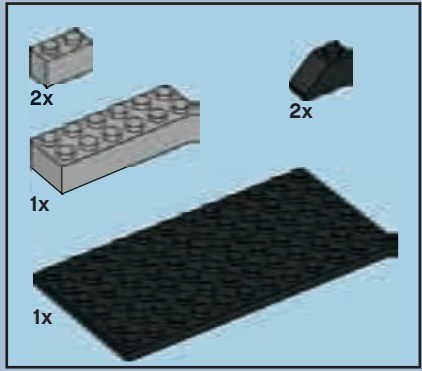

4

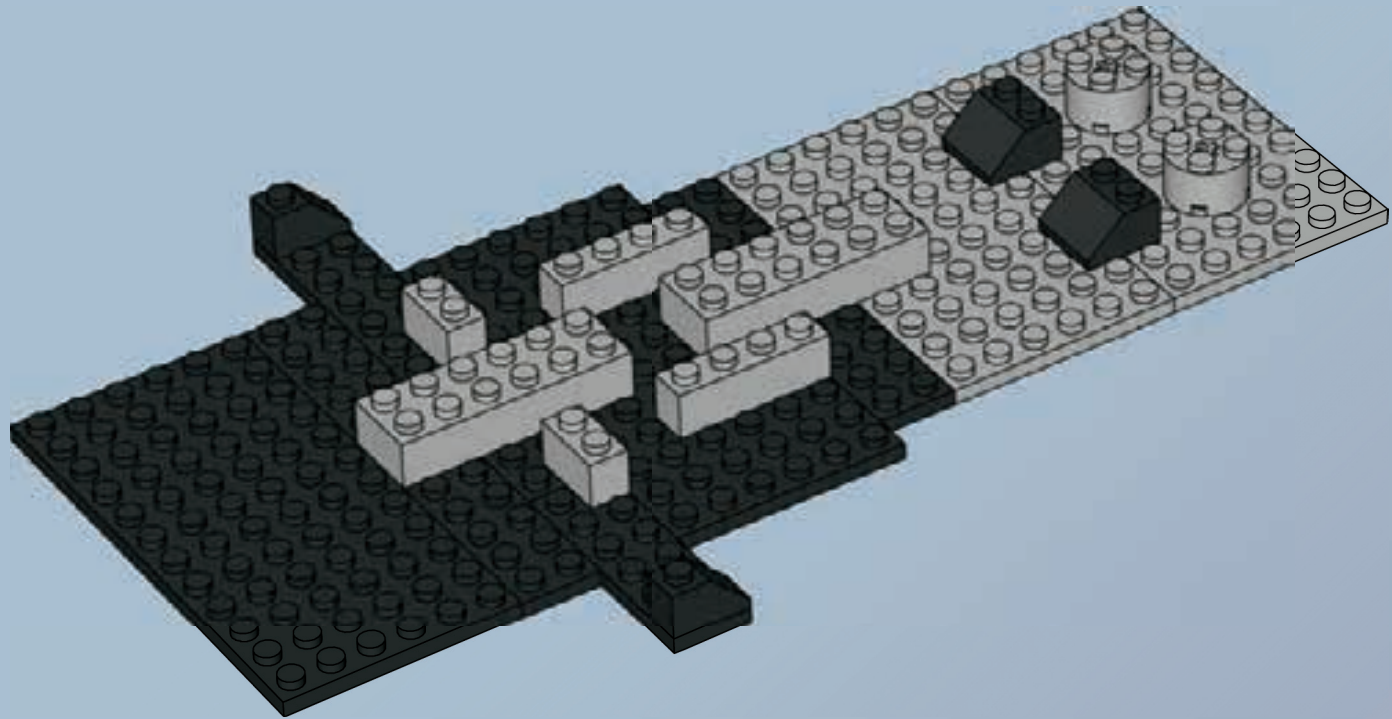

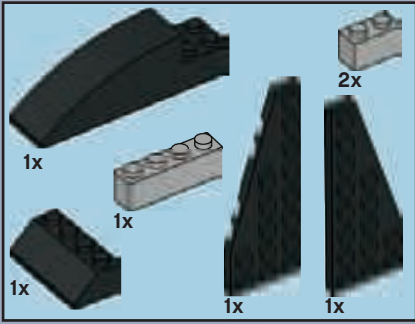

5

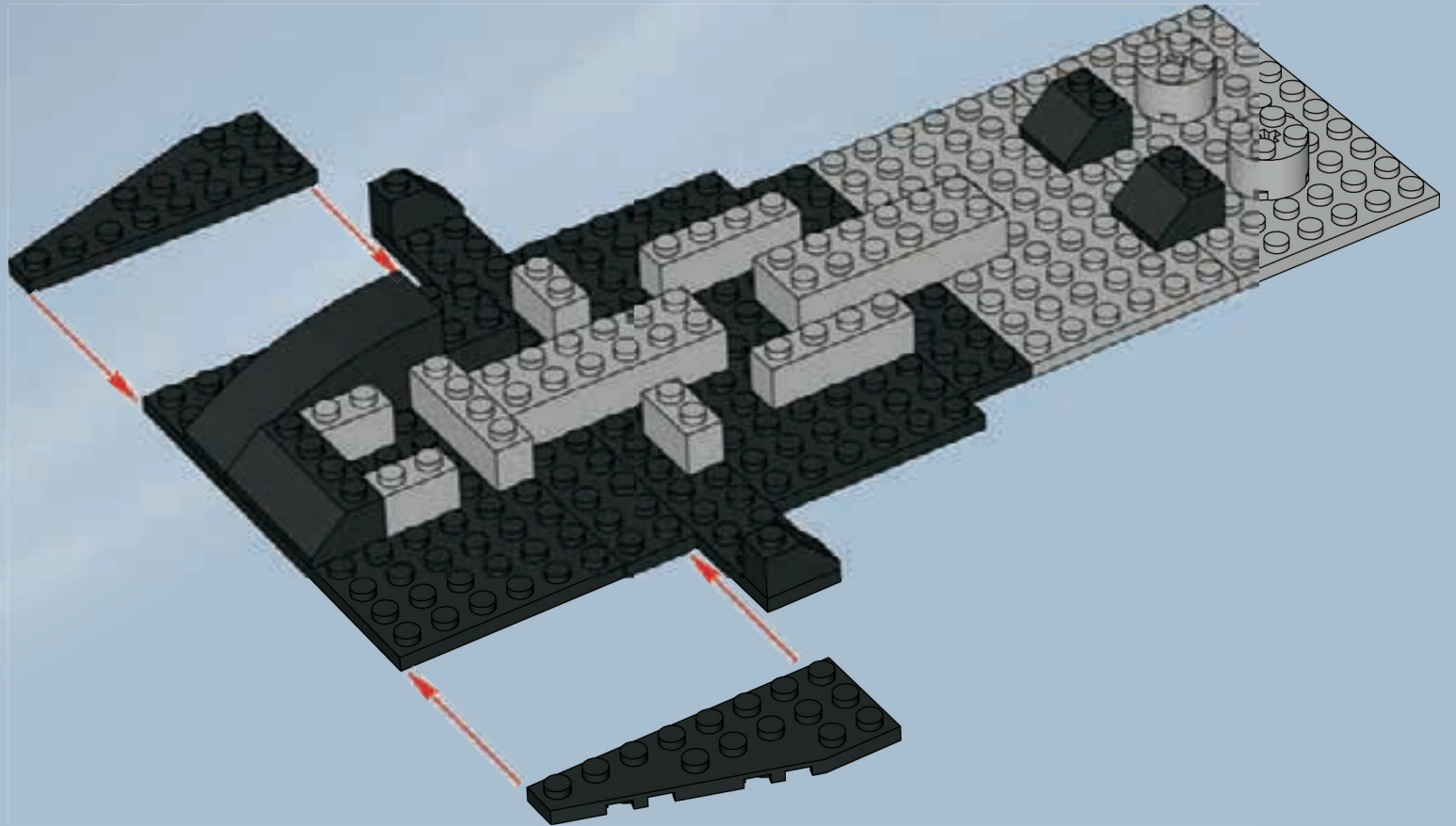

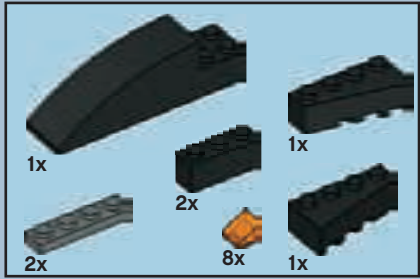

6

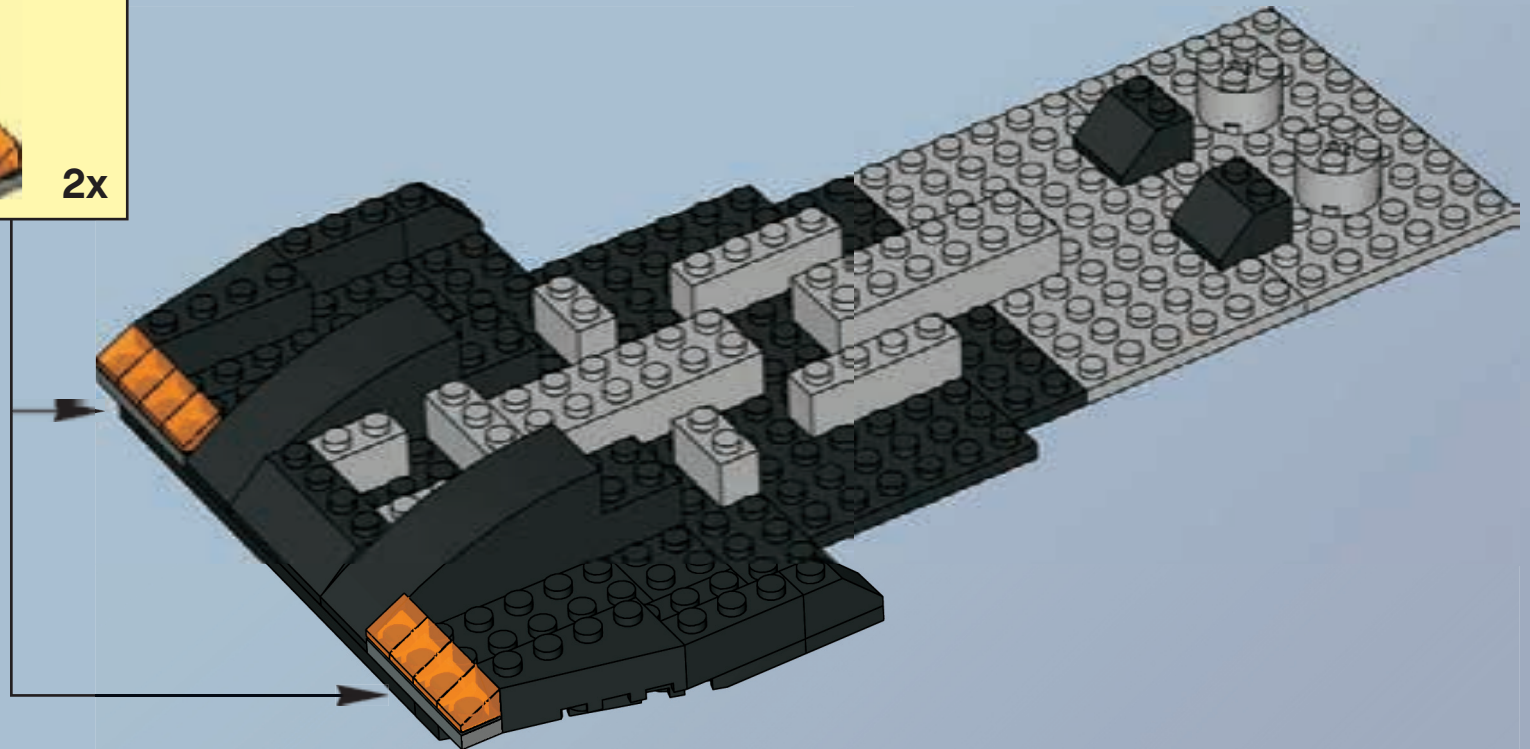



11

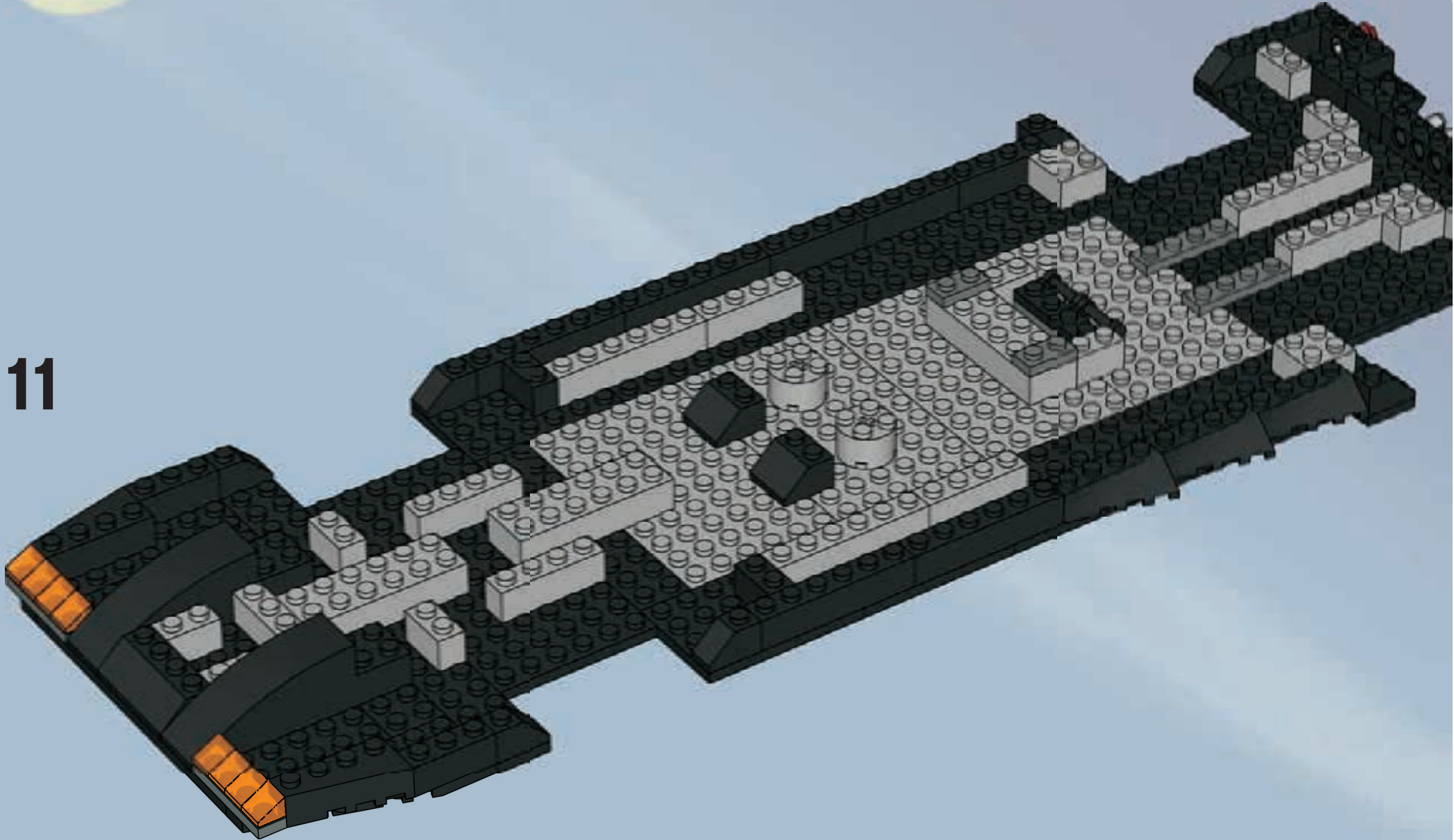

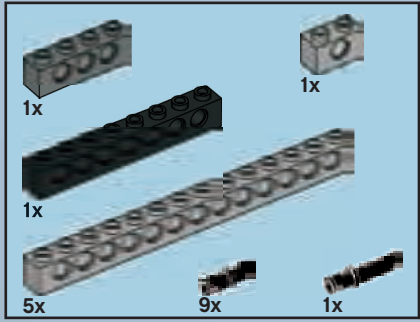

12

1

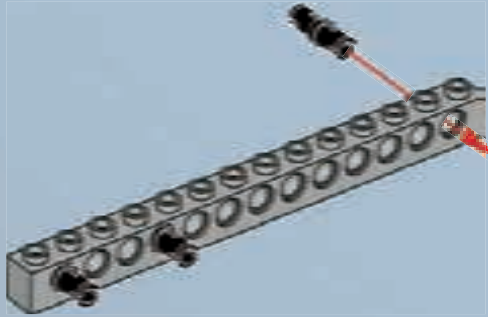

2

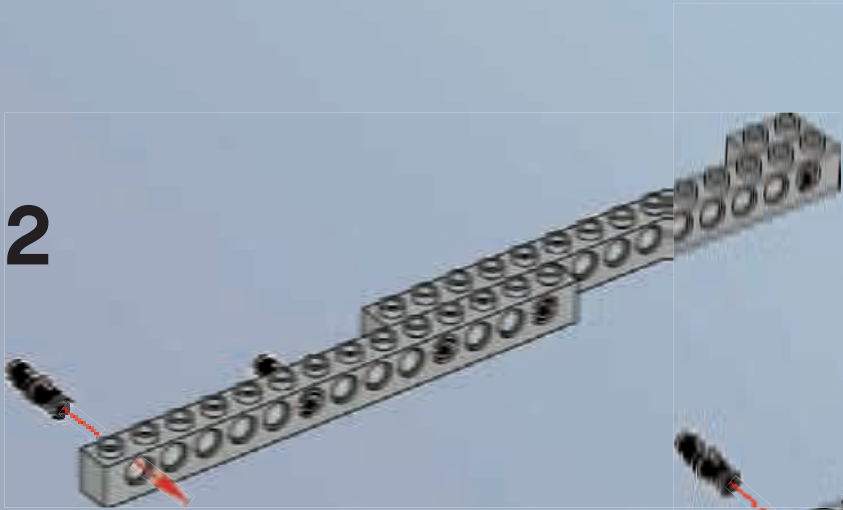

3

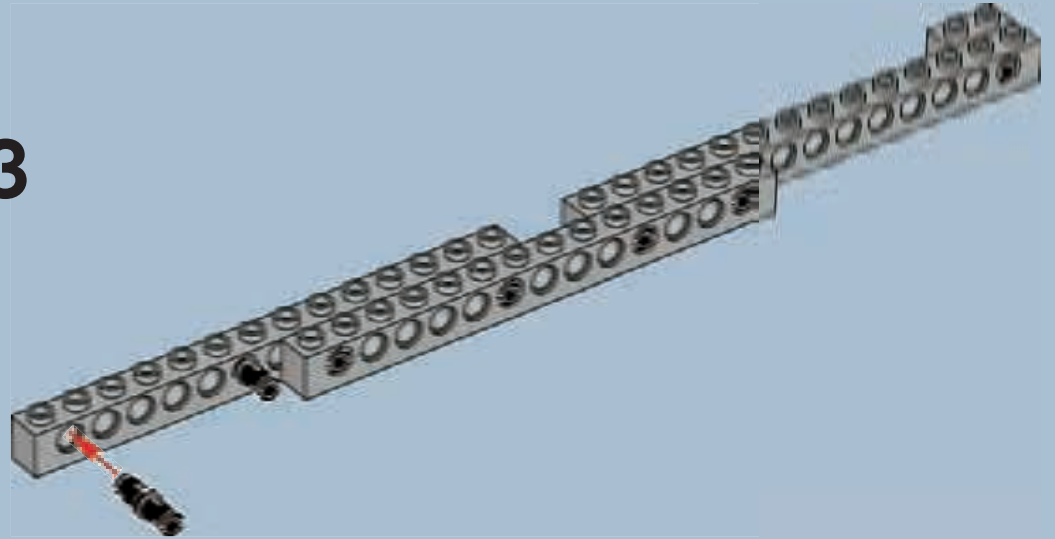

4

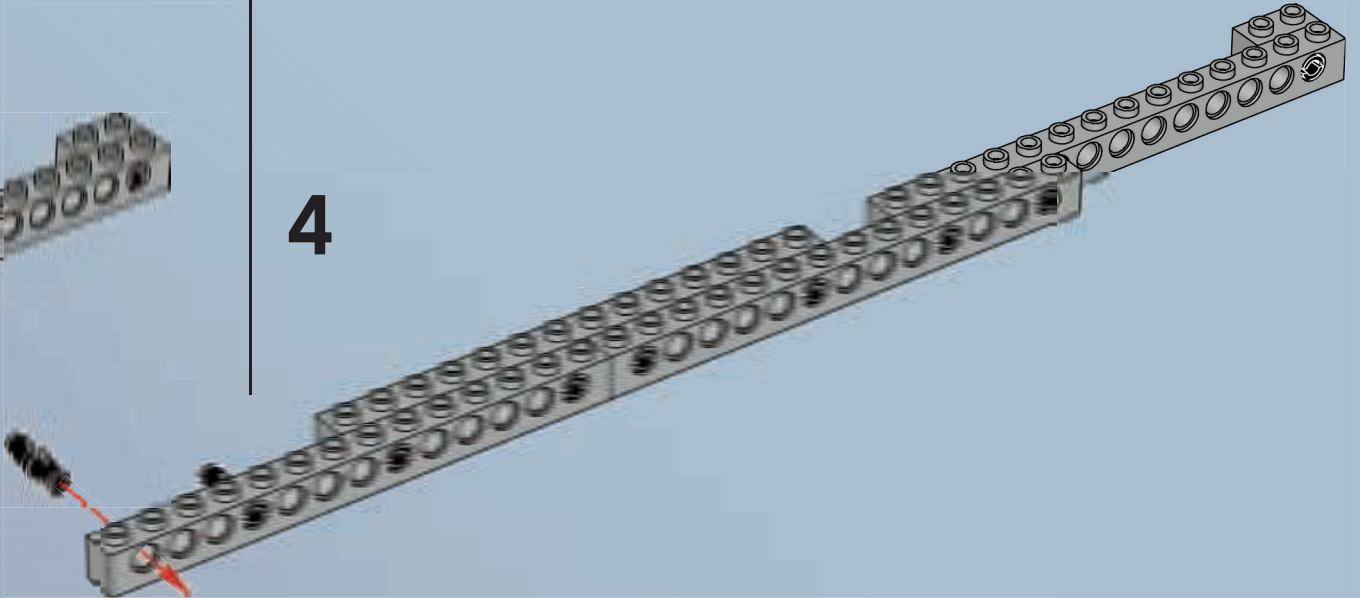



5

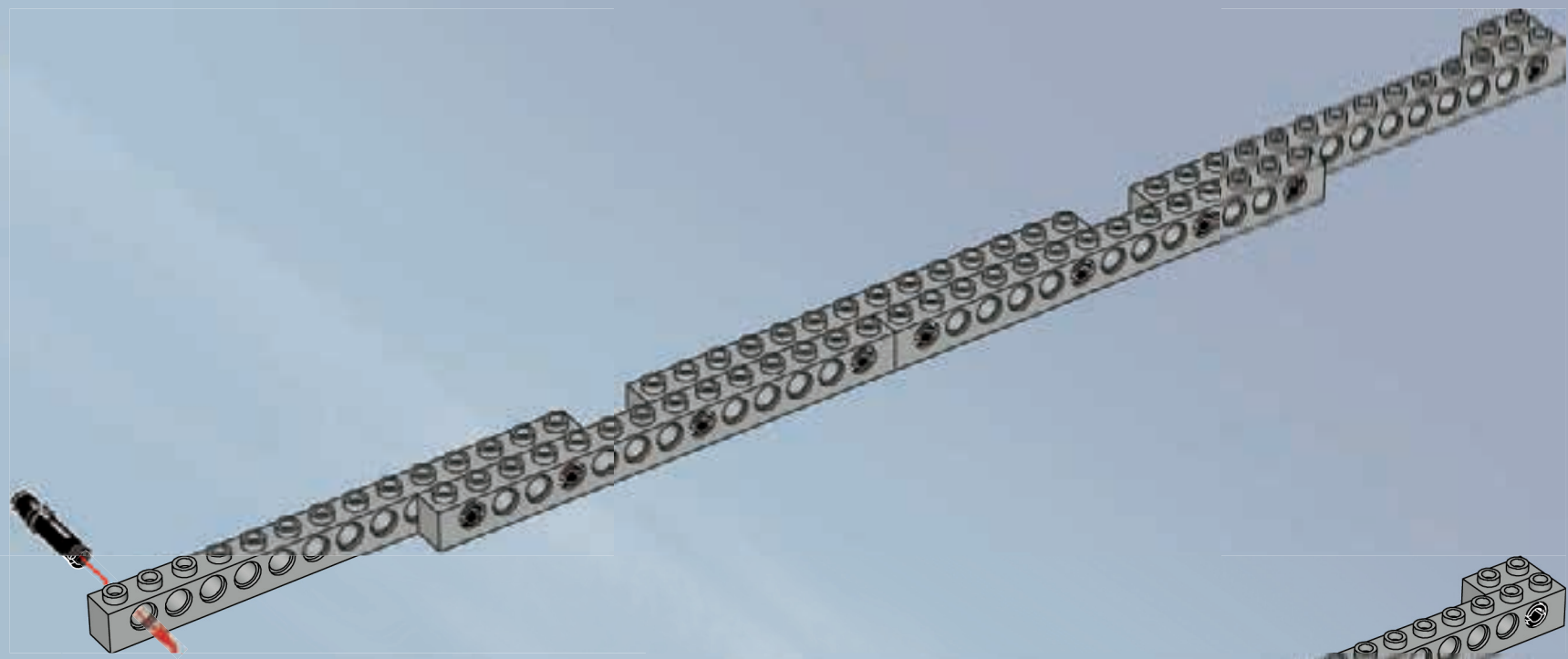

6

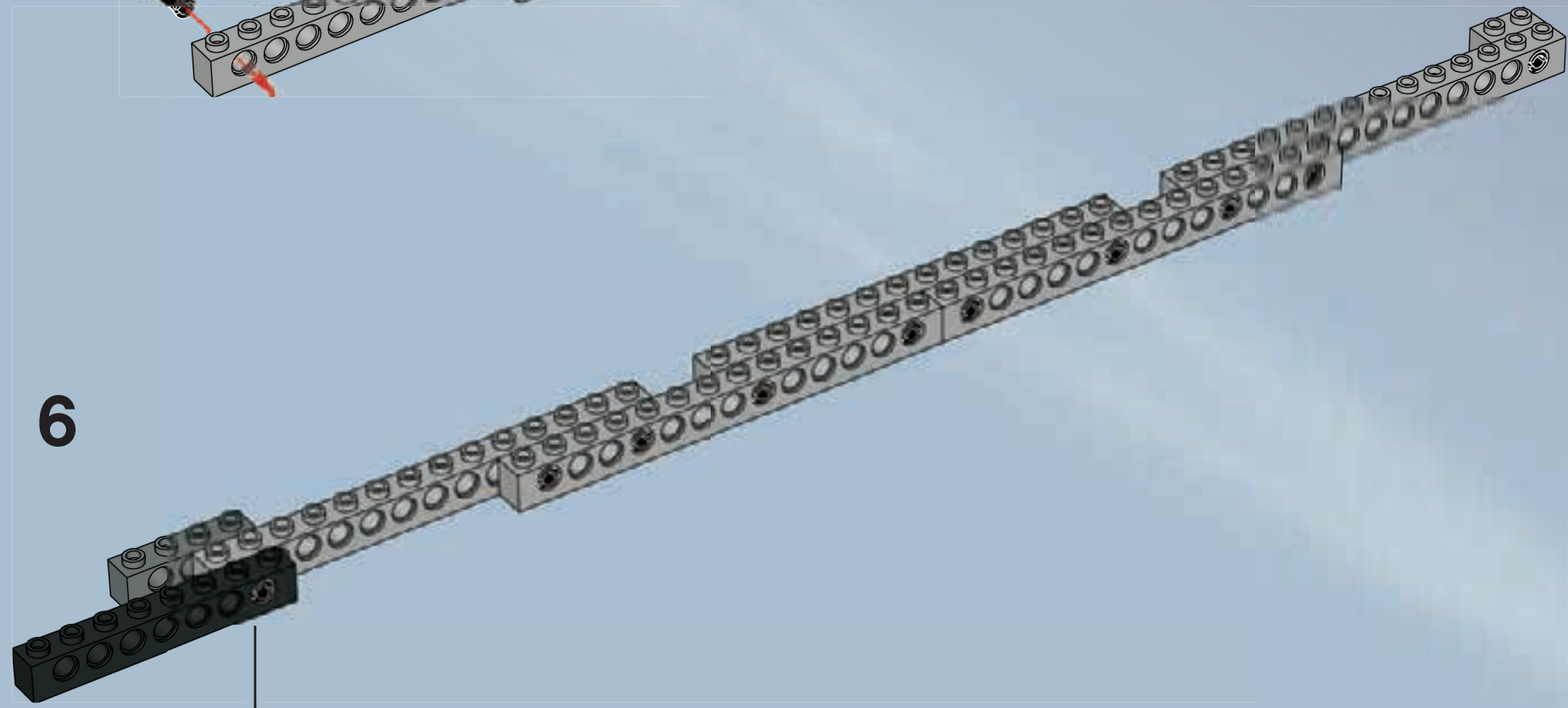

12

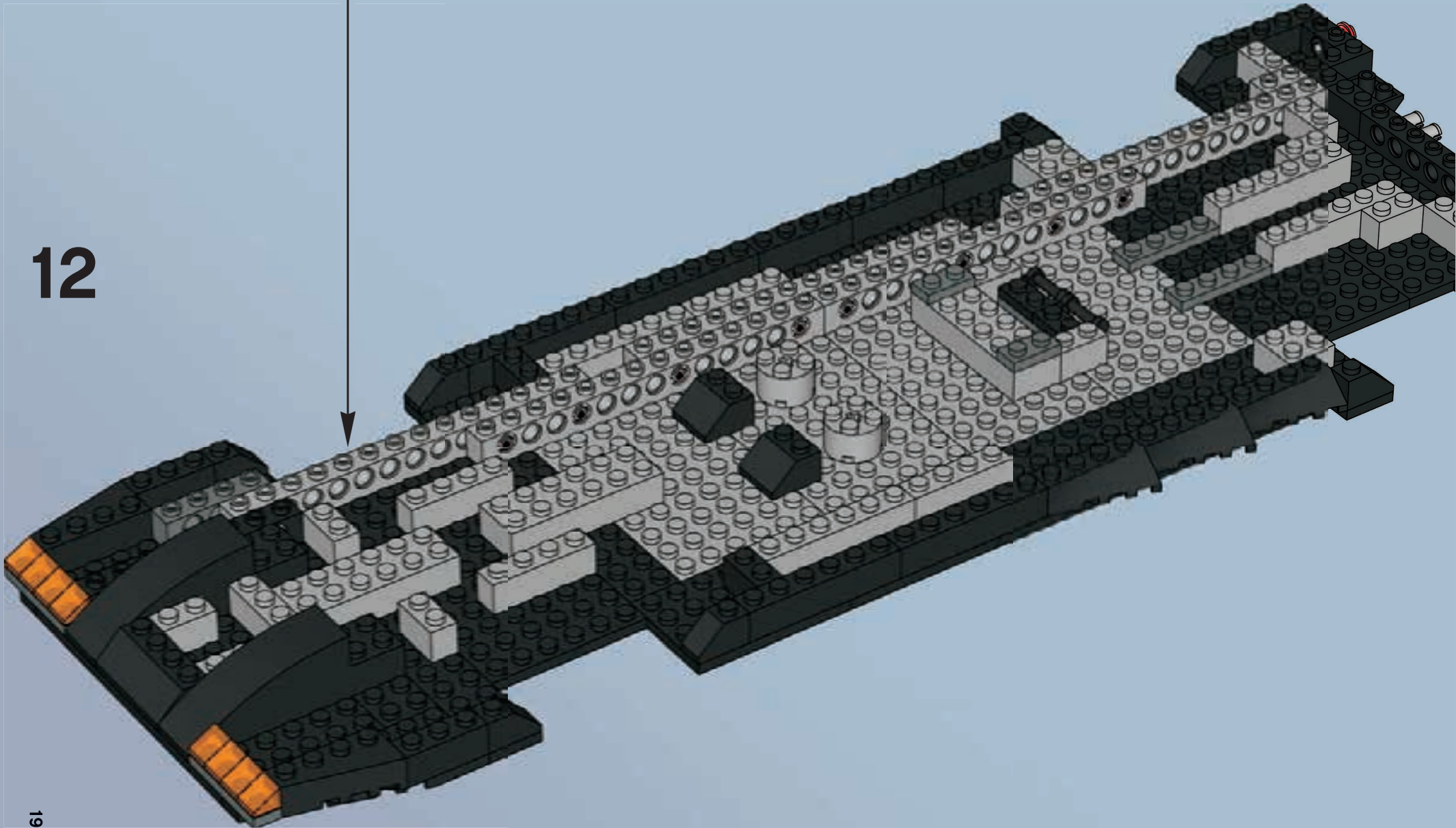

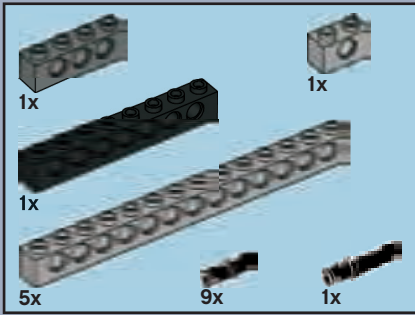

13

1



2

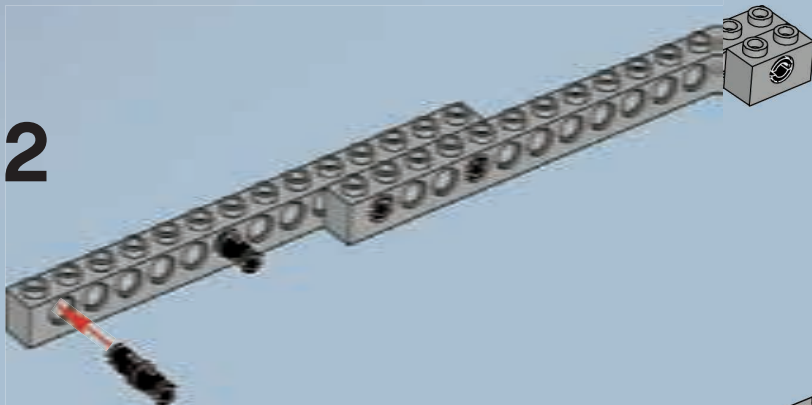

3

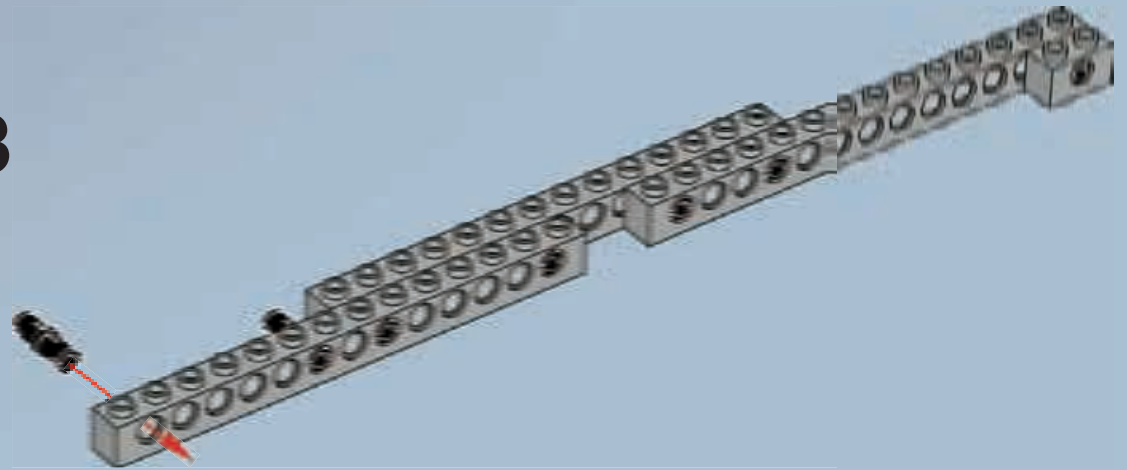

4

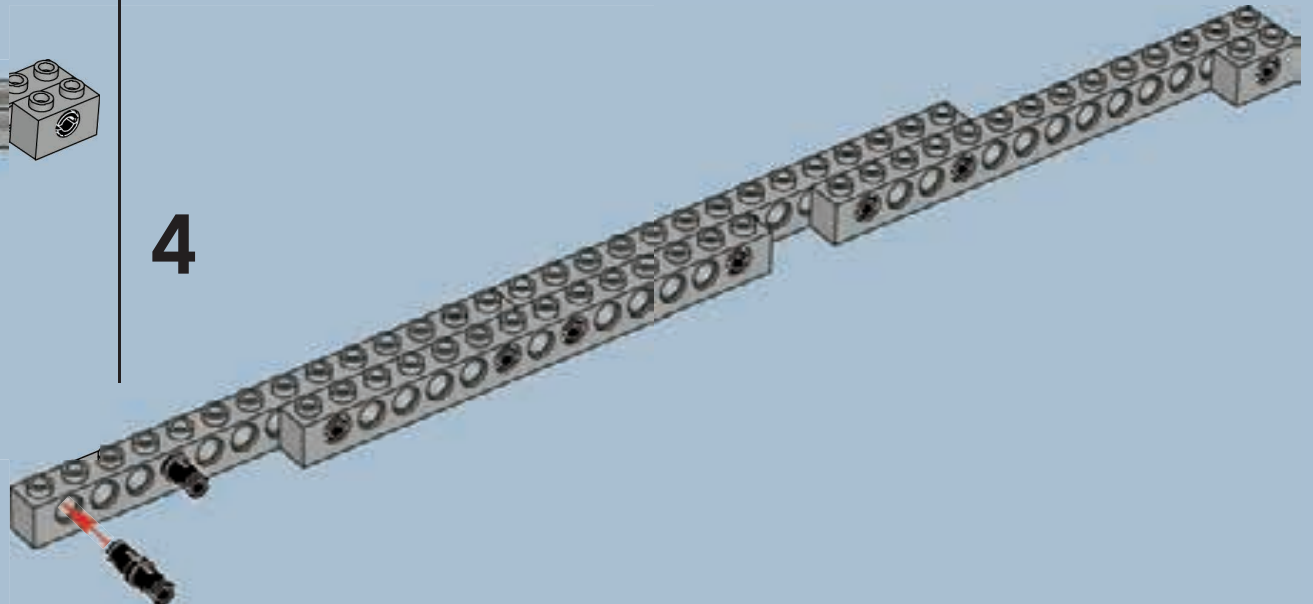

5

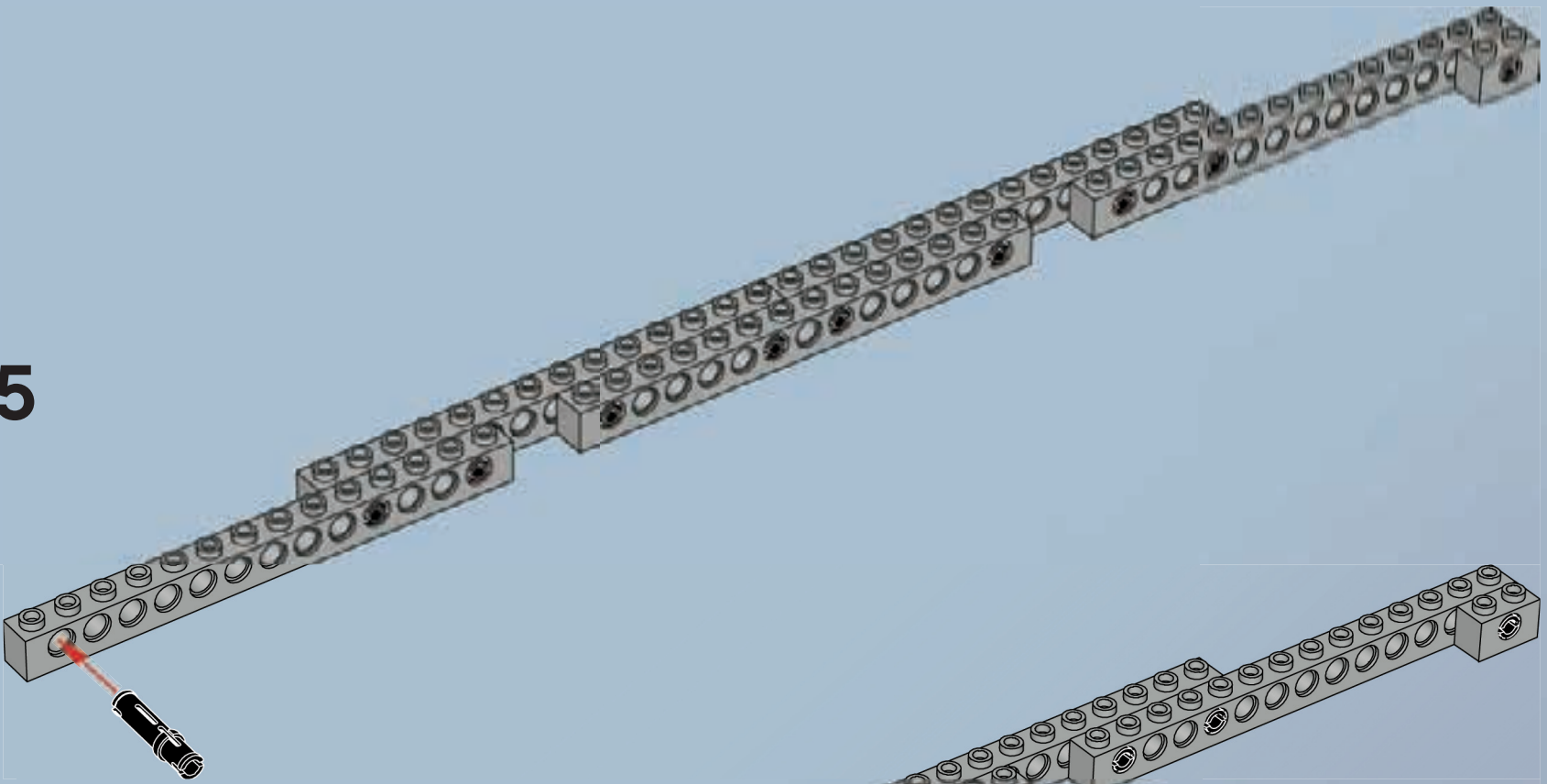

6

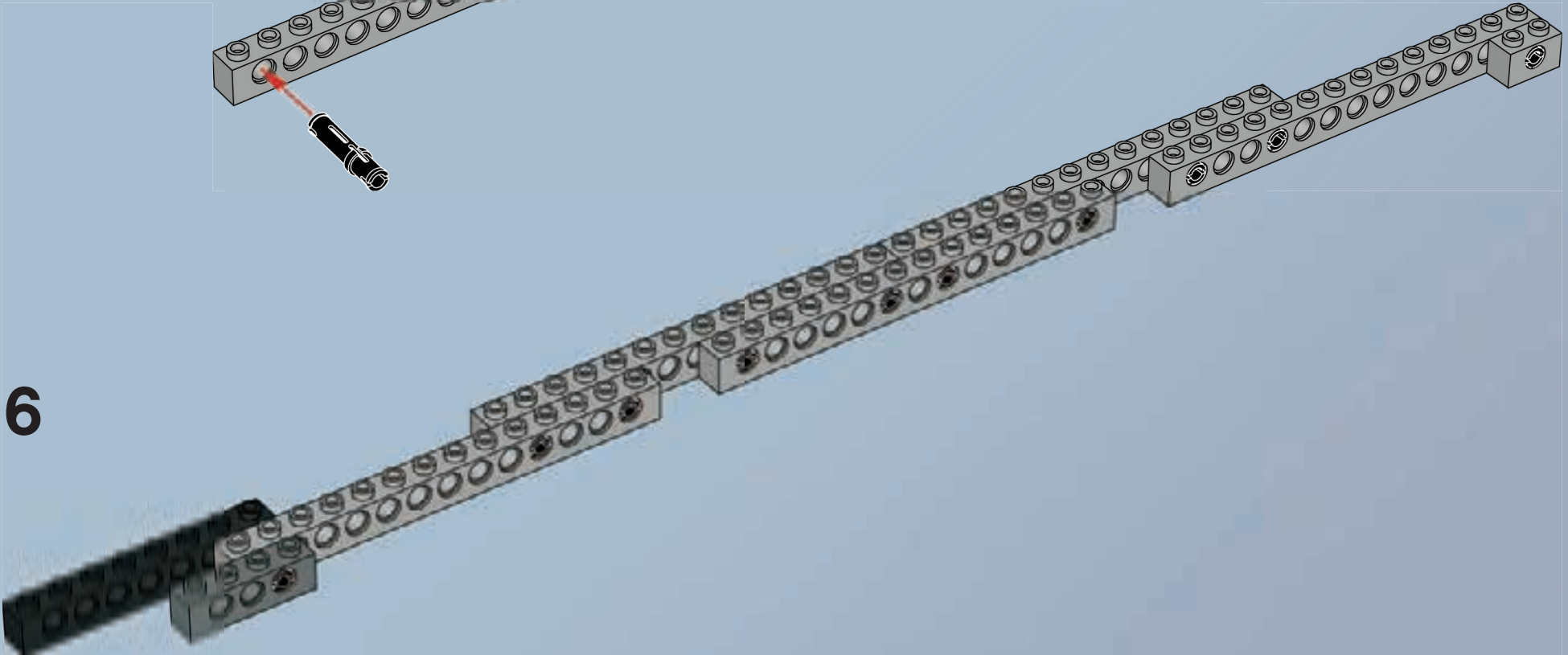

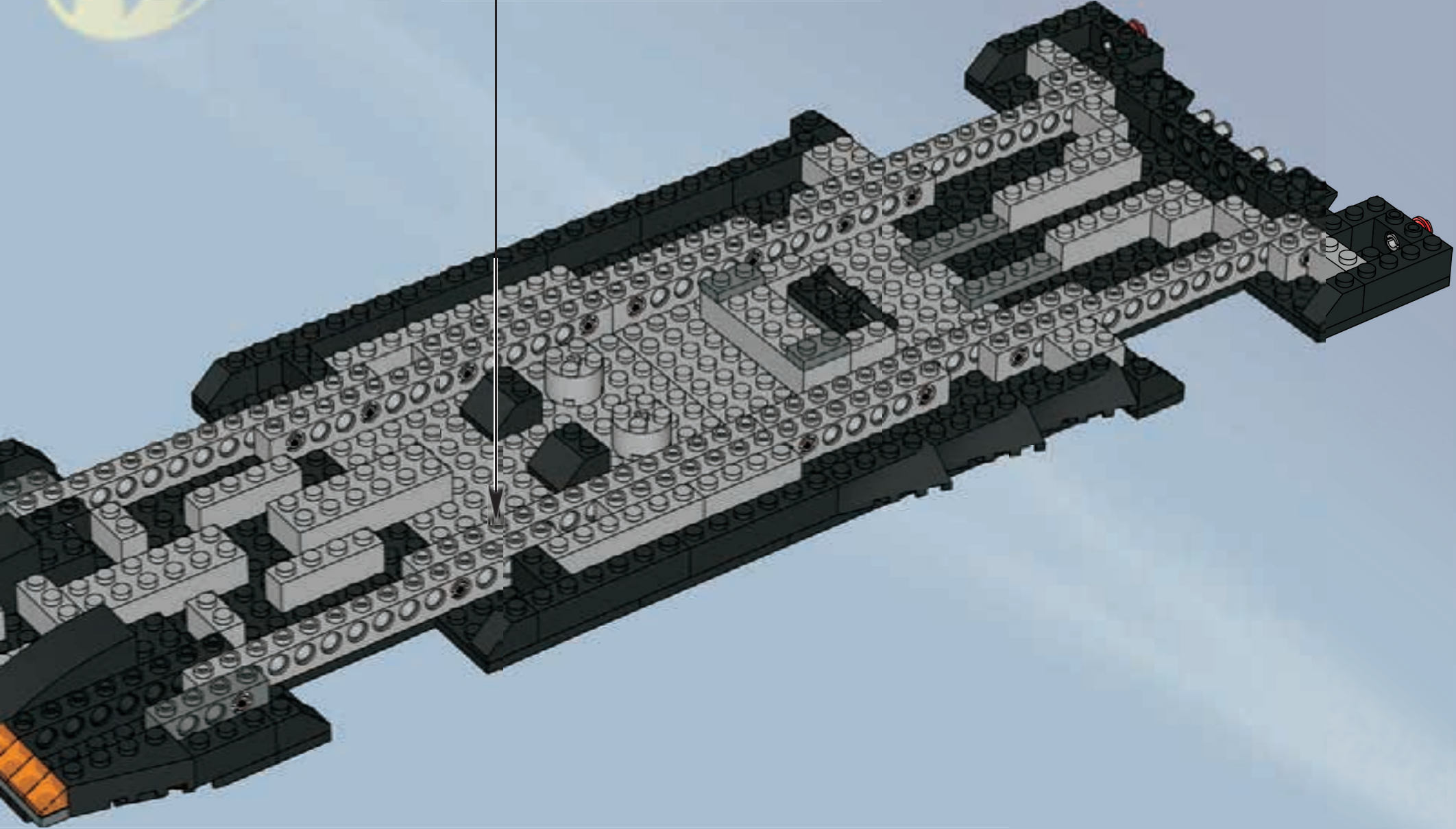



14

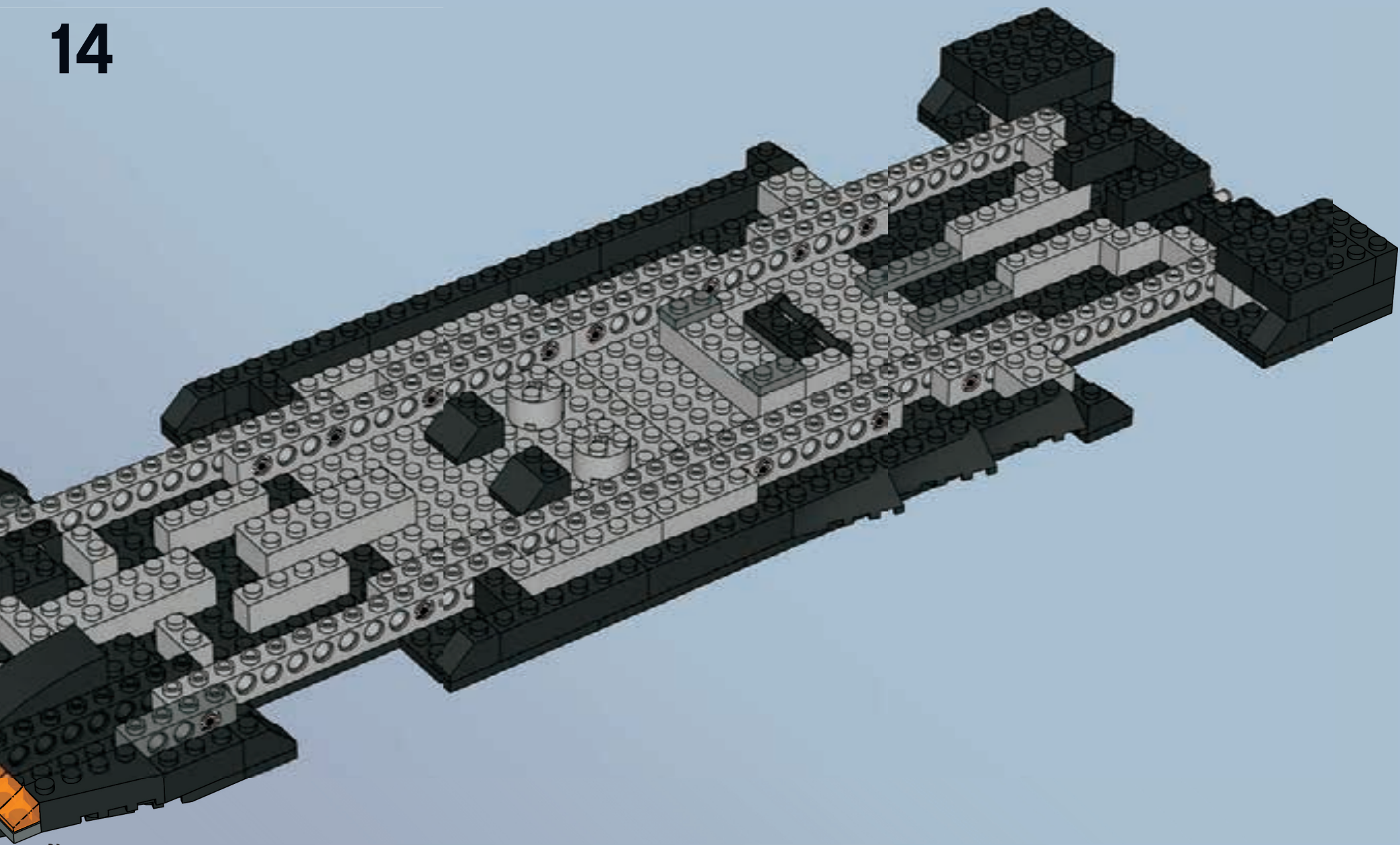

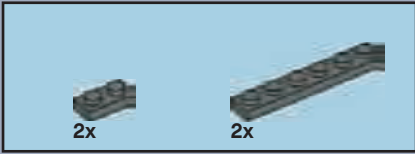

15

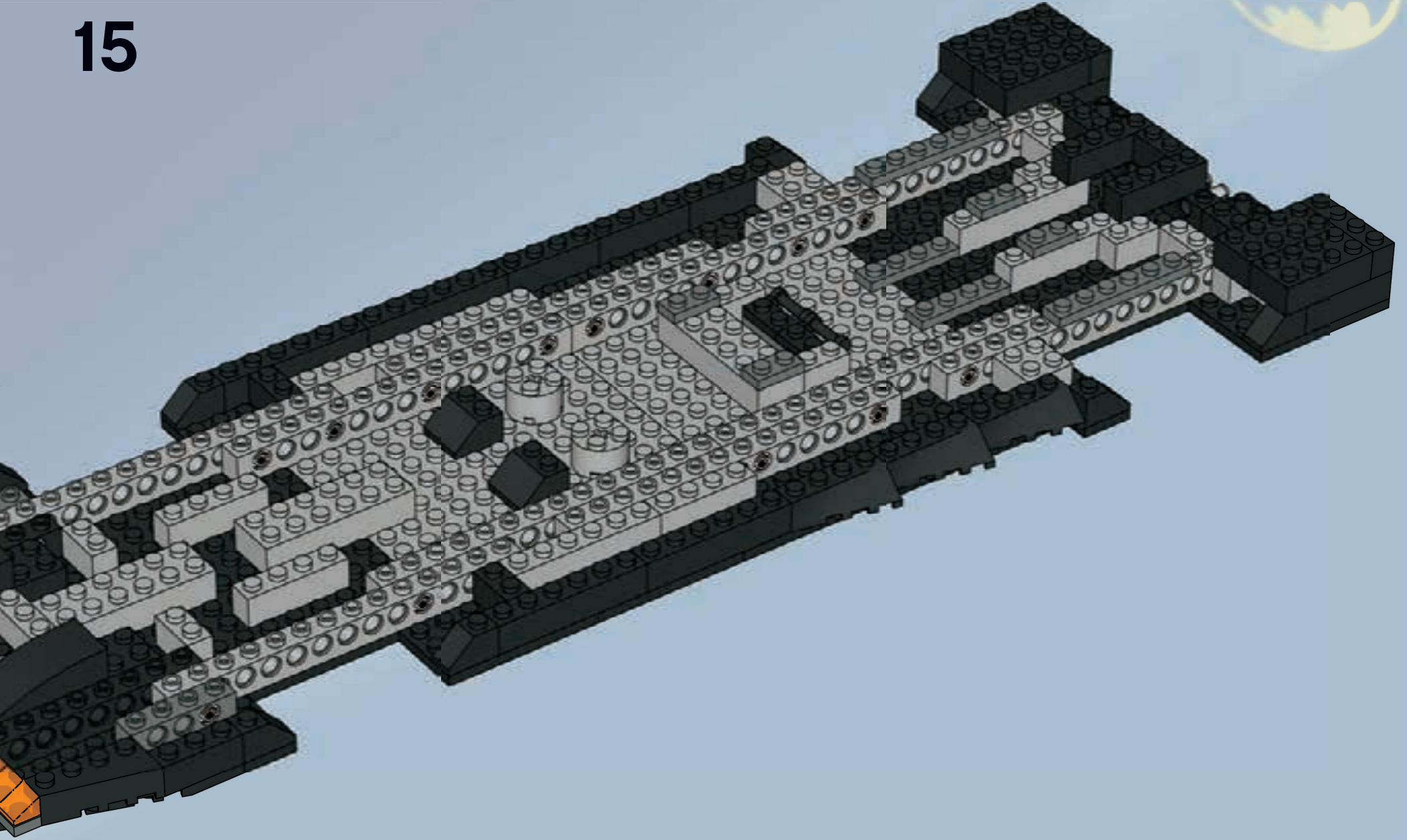

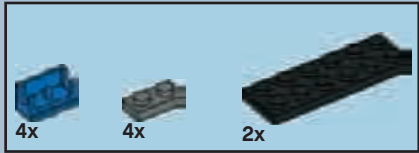

16

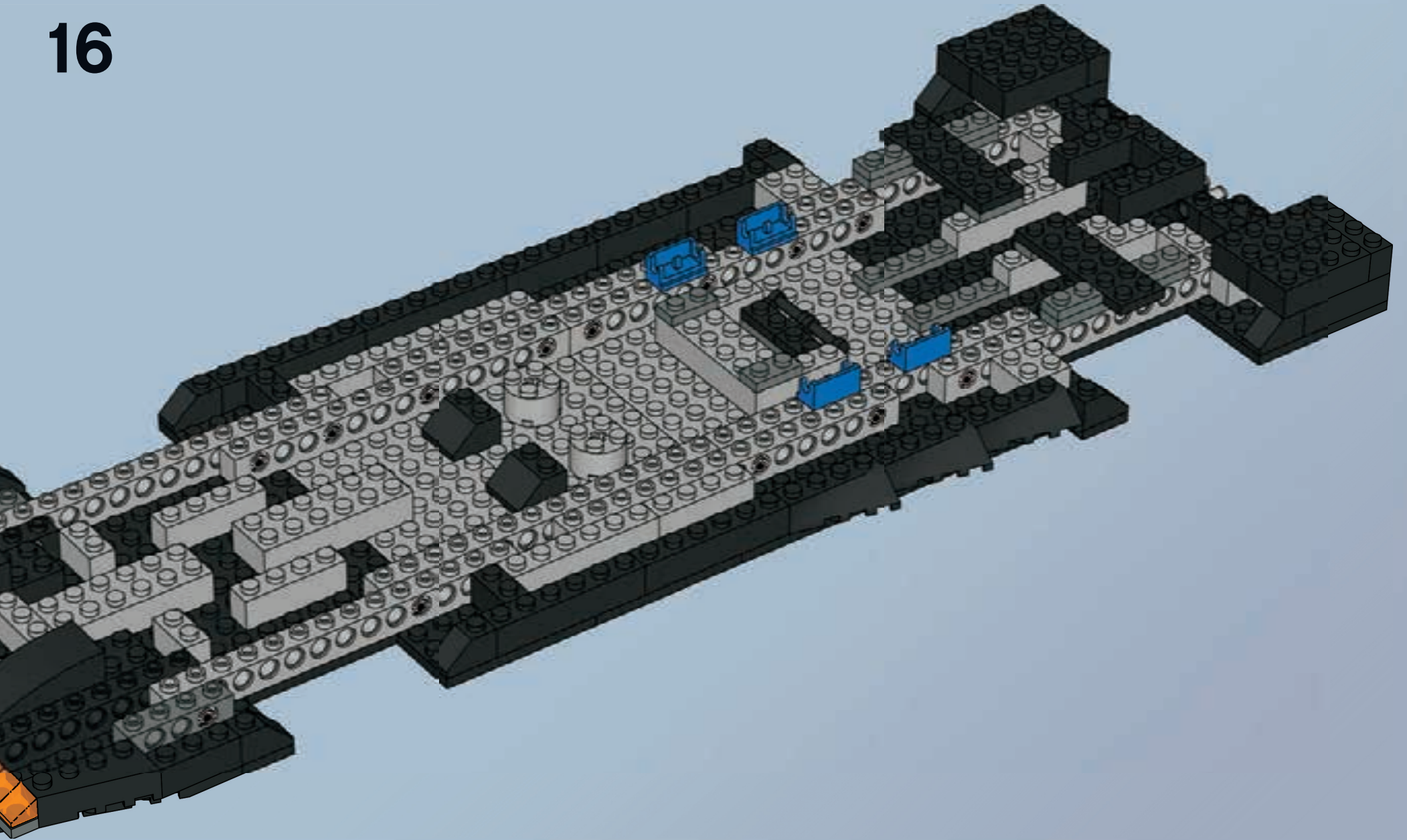

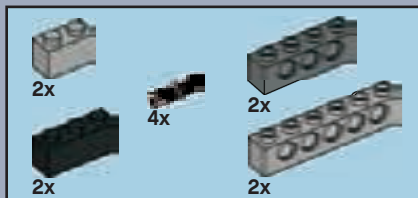

17

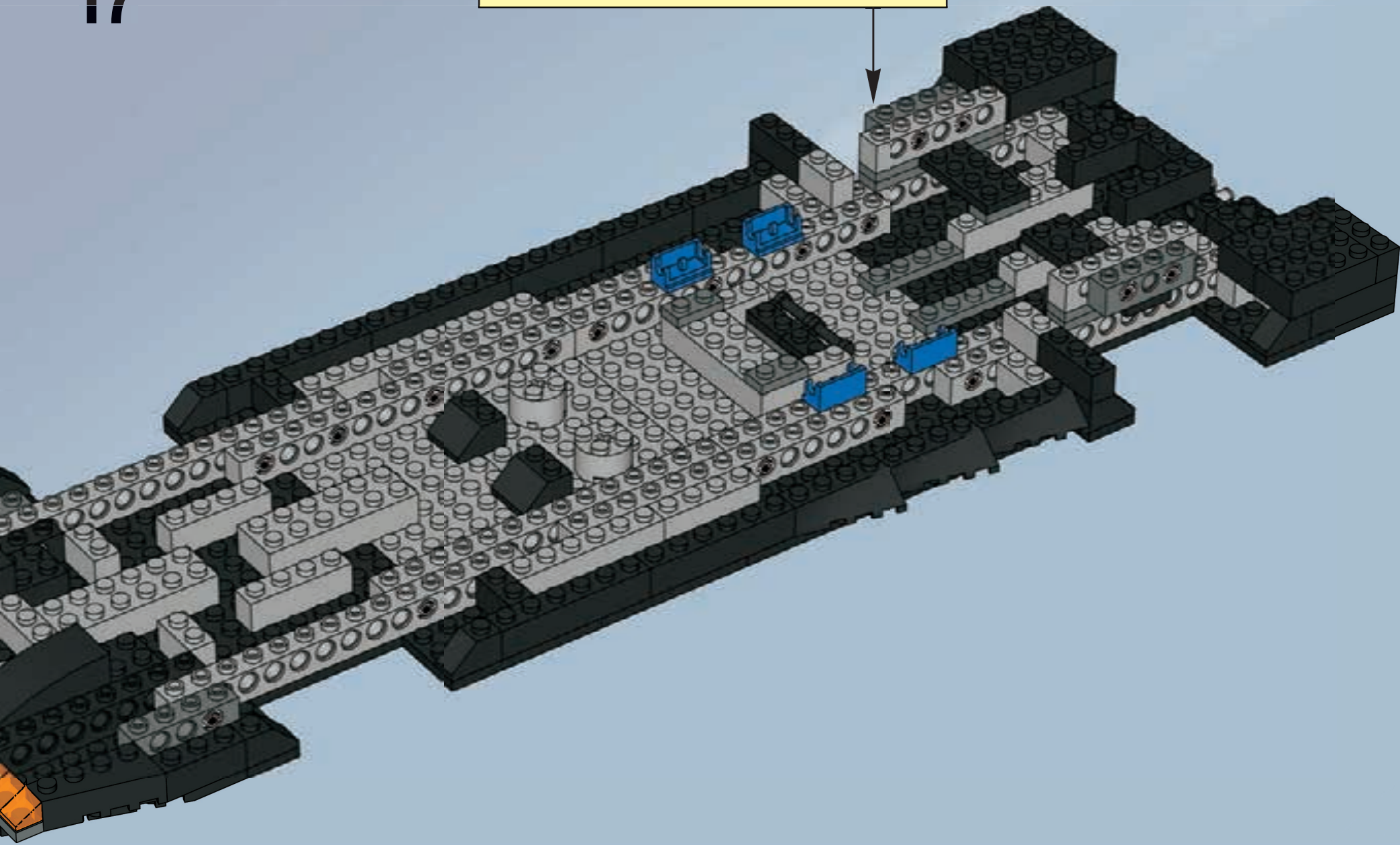
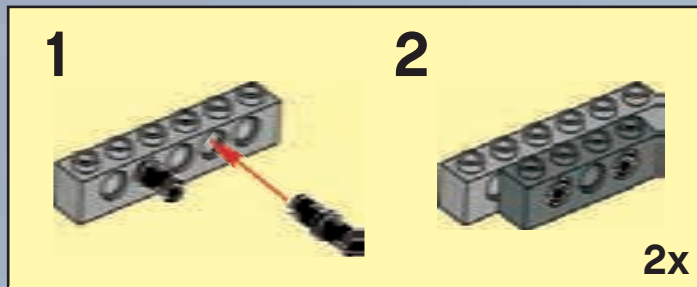



18

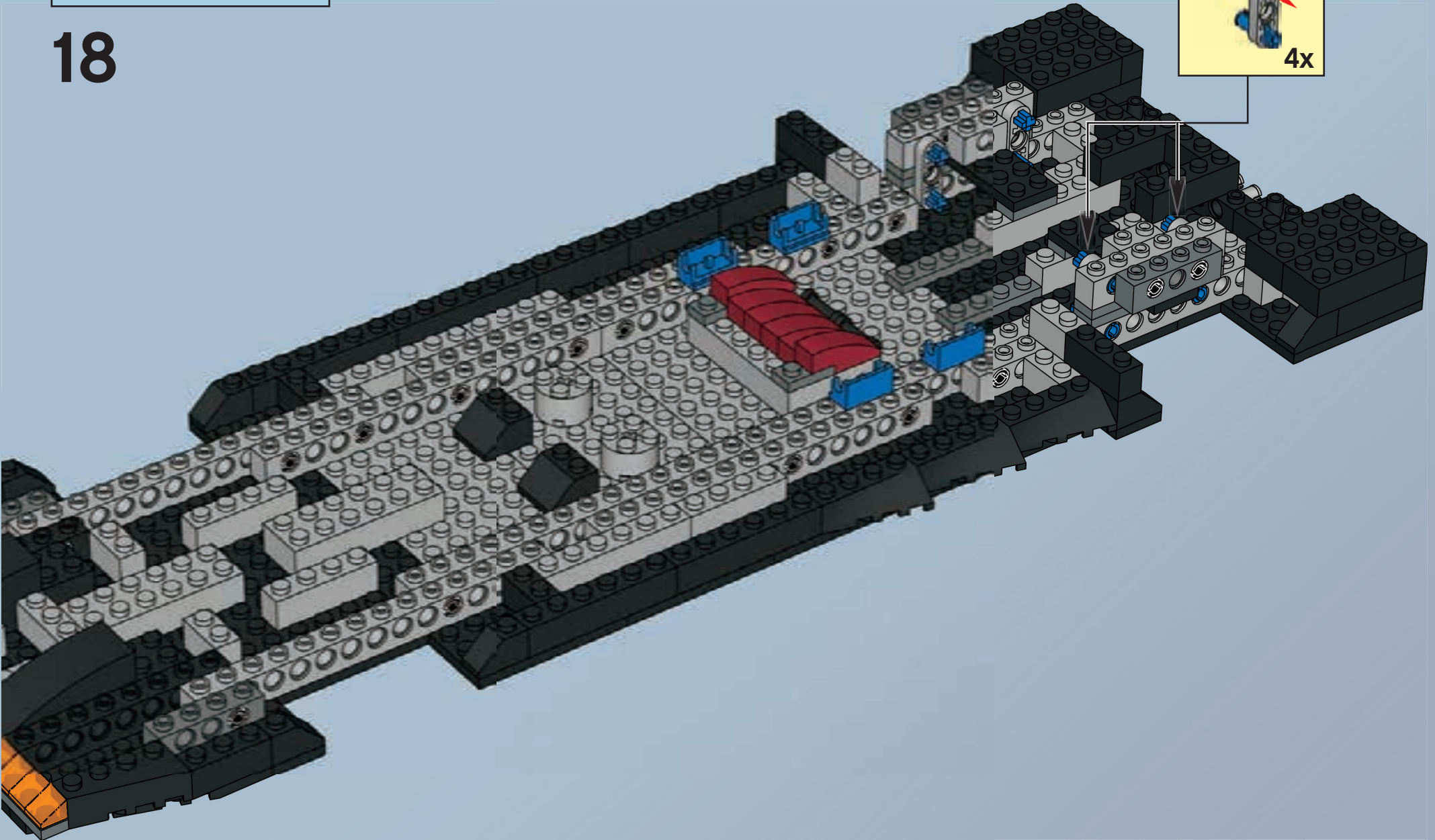
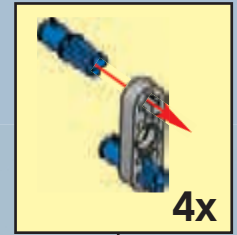



19

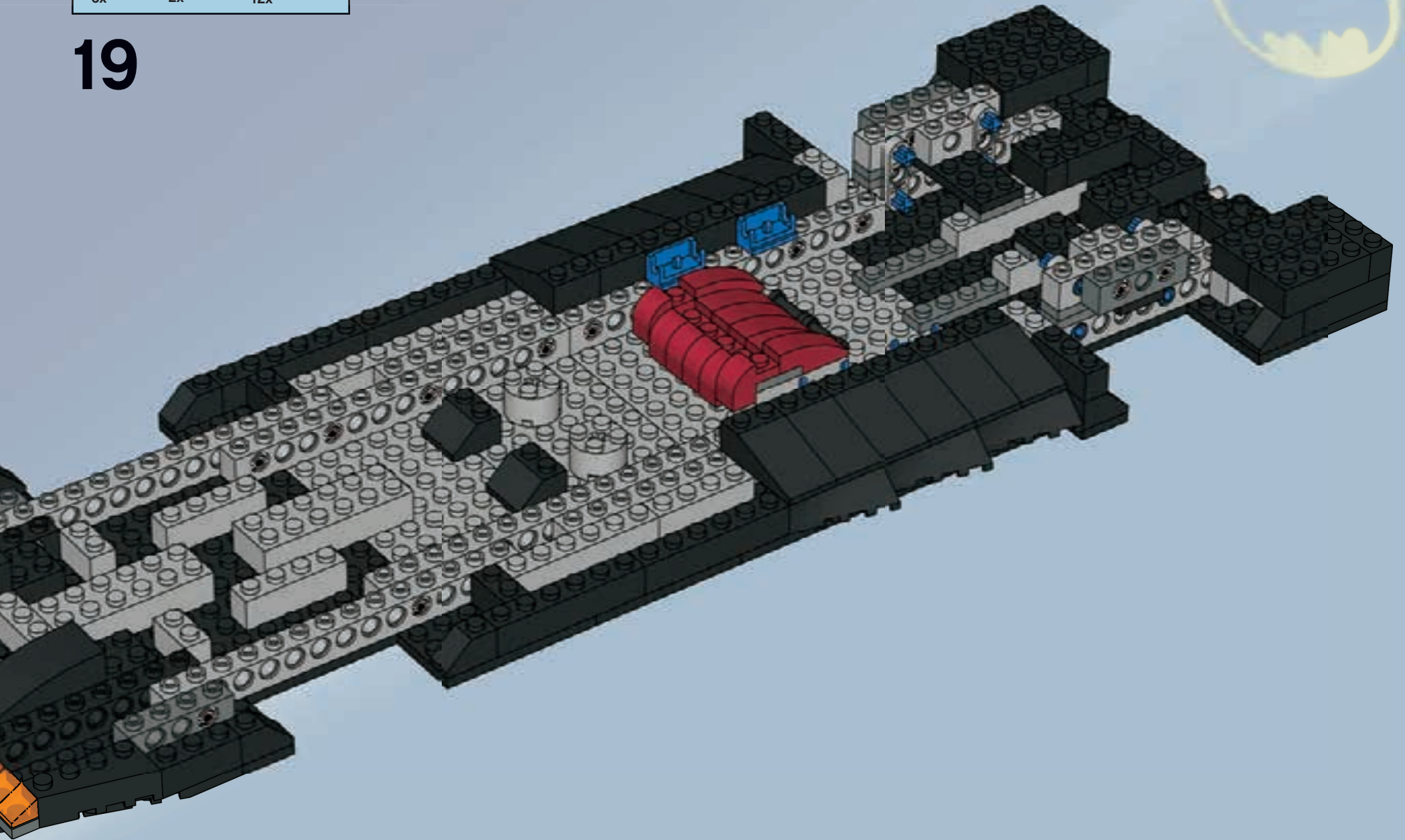



20

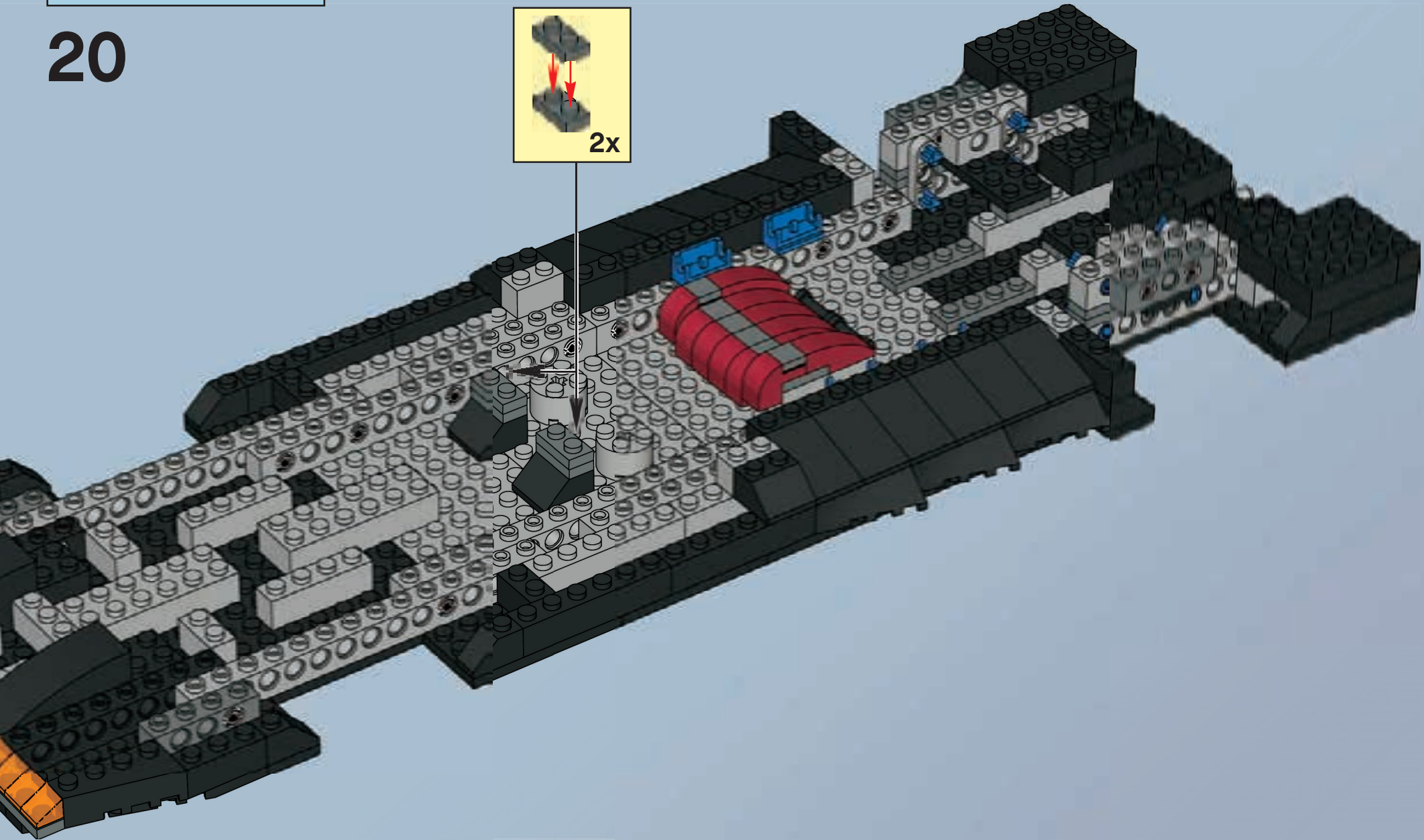

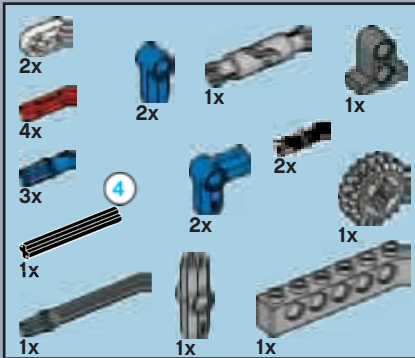

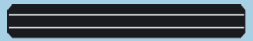
 4 **1:1**

21

1

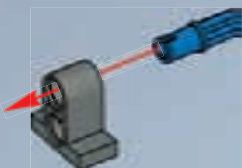

2



3



4

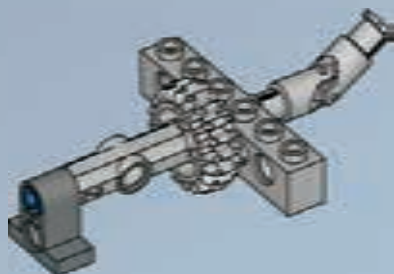

1

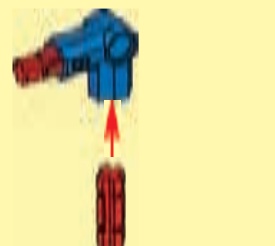

2



3



5

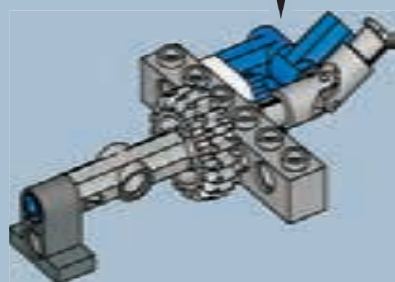

1



2



3

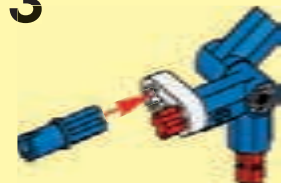

6

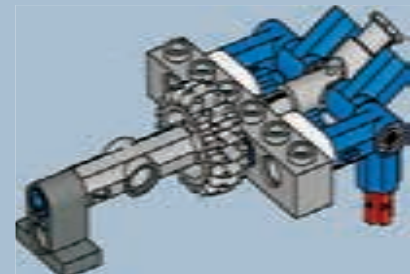

7

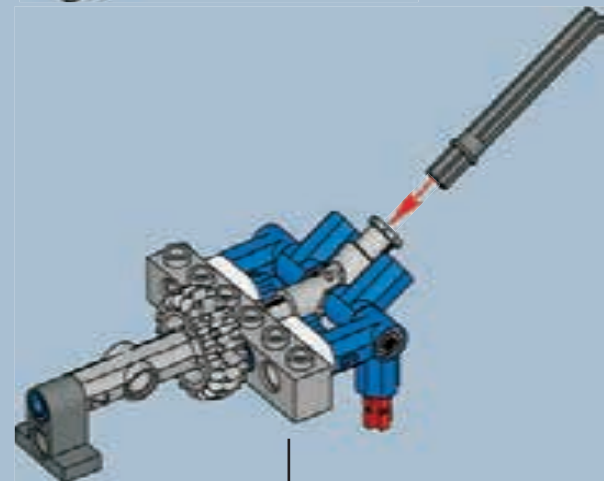

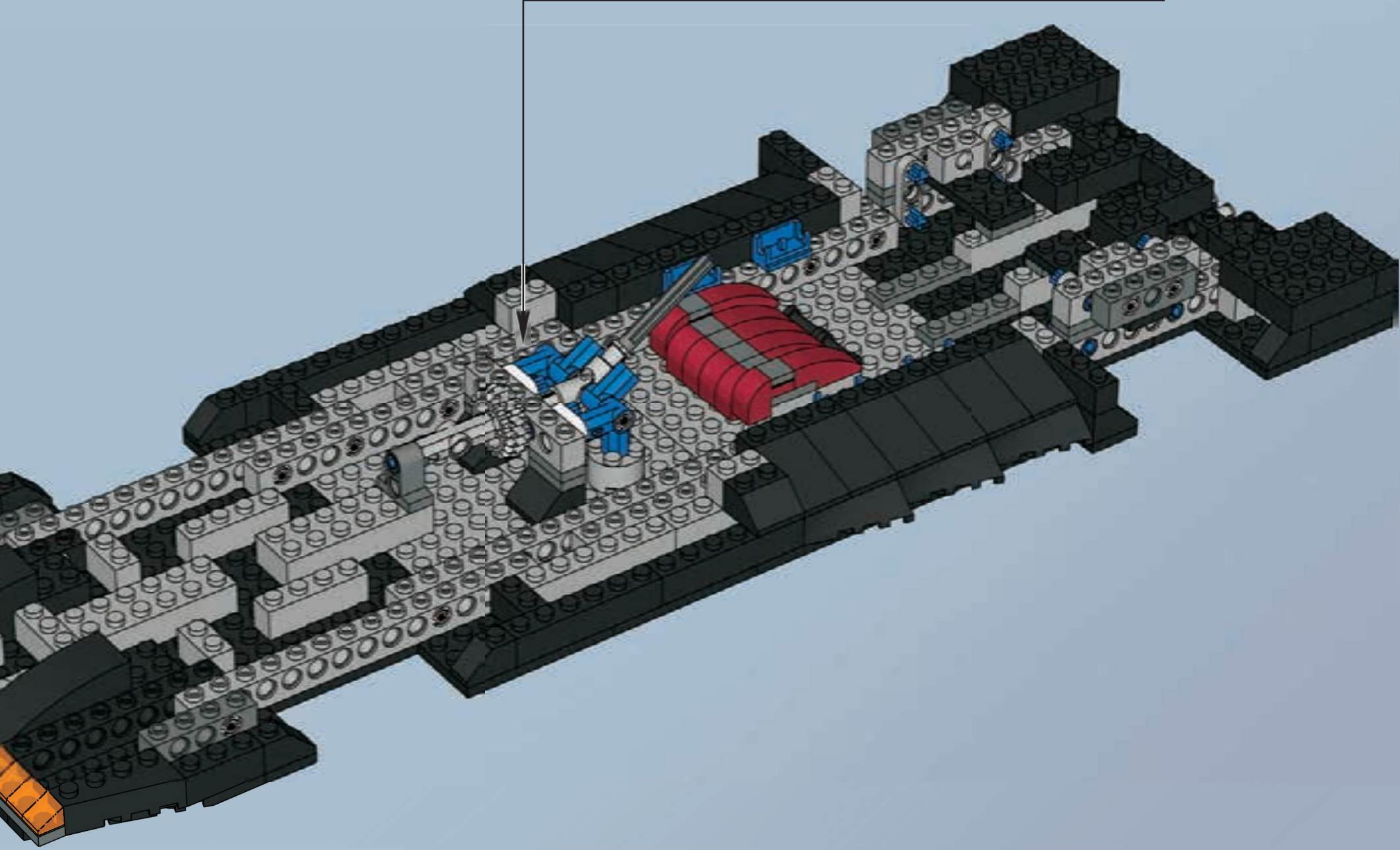

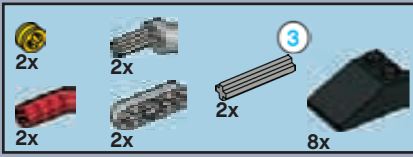

22

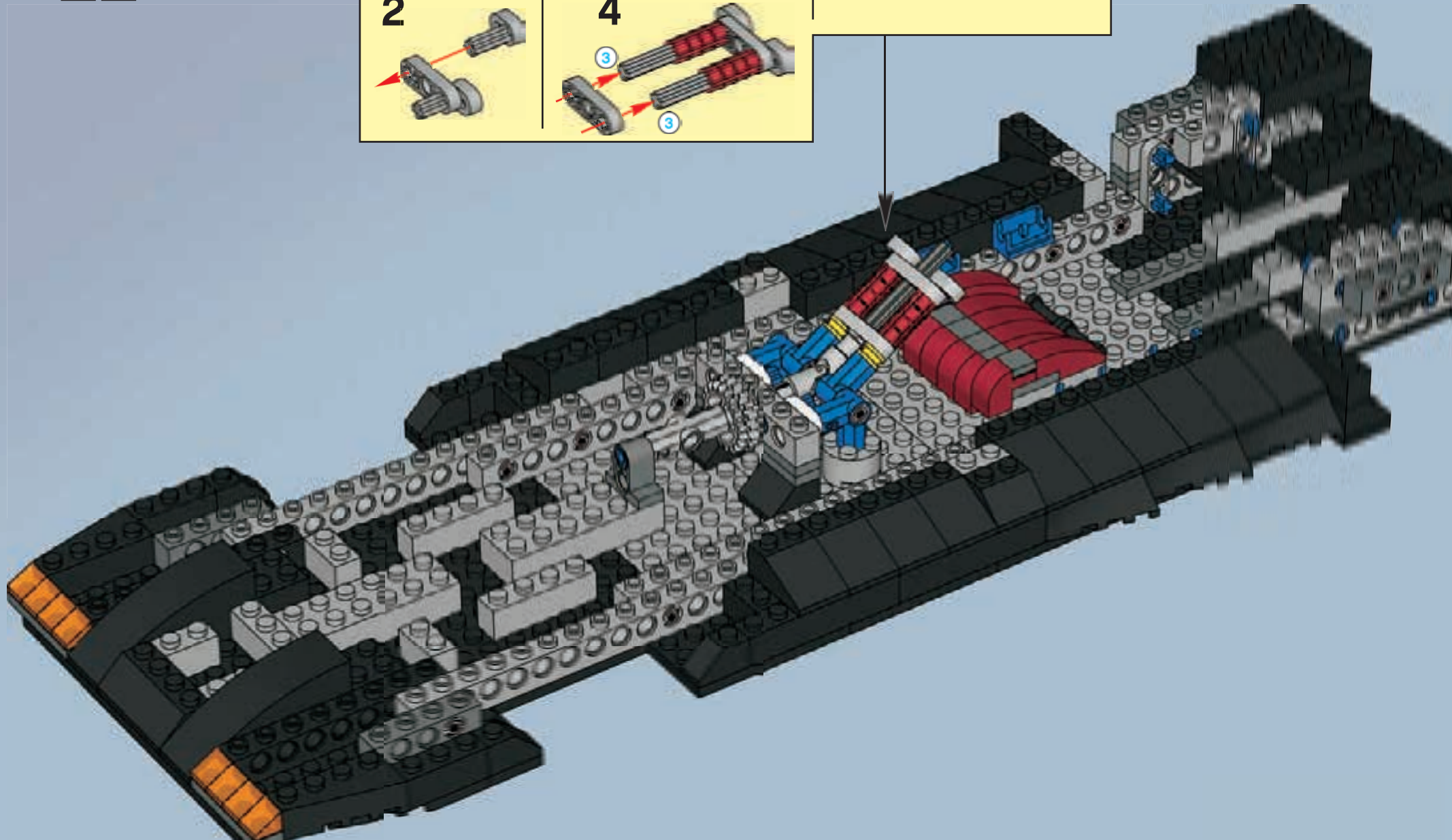
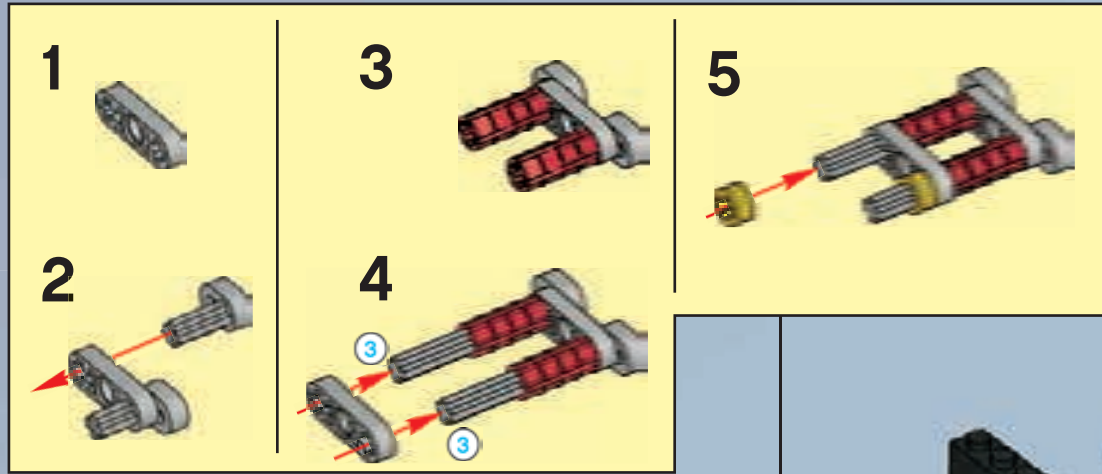

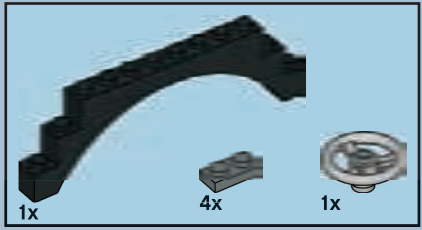

23

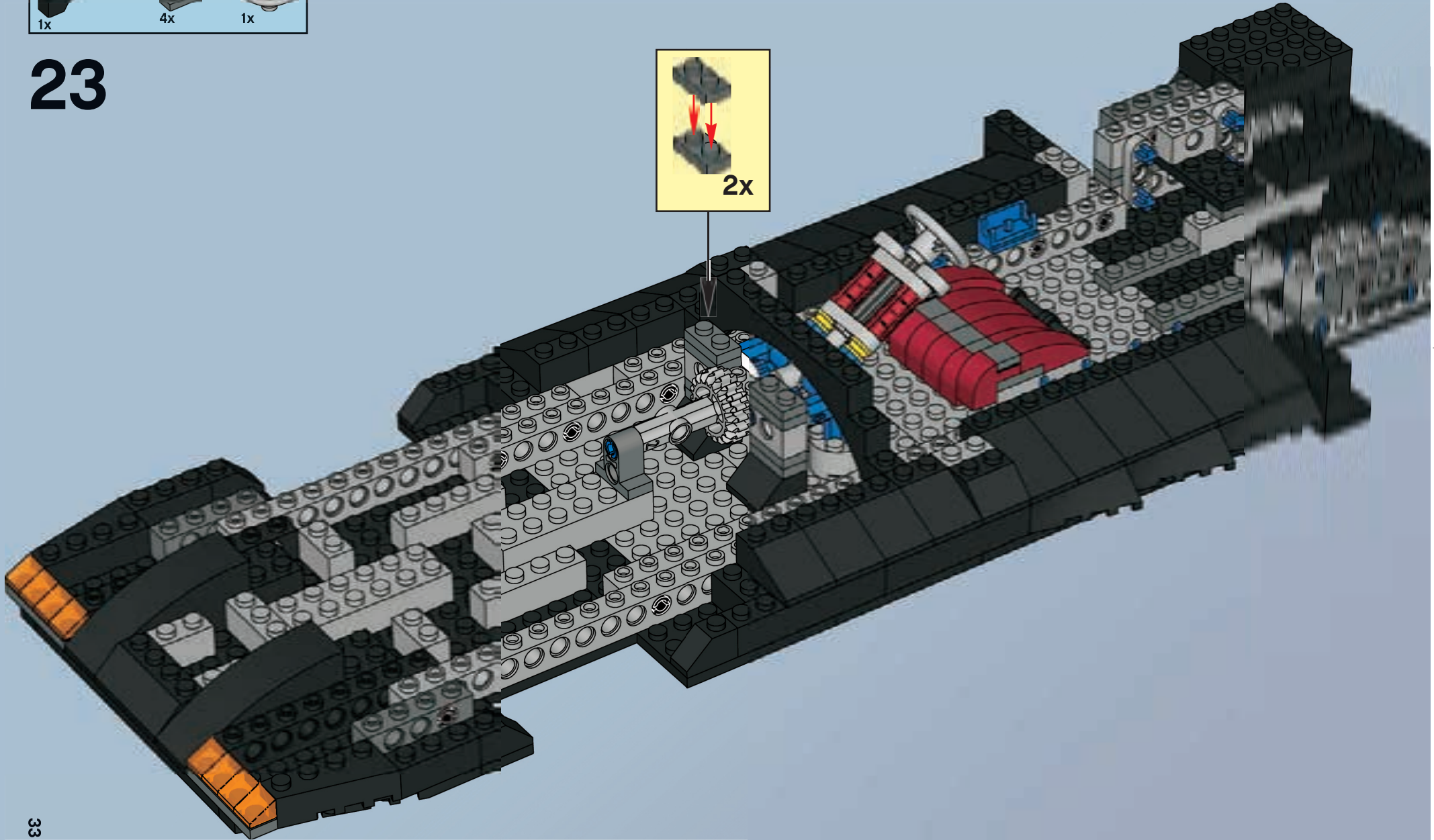
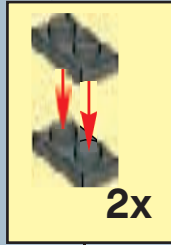

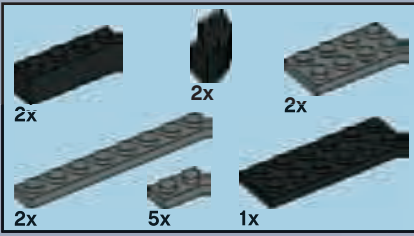

24

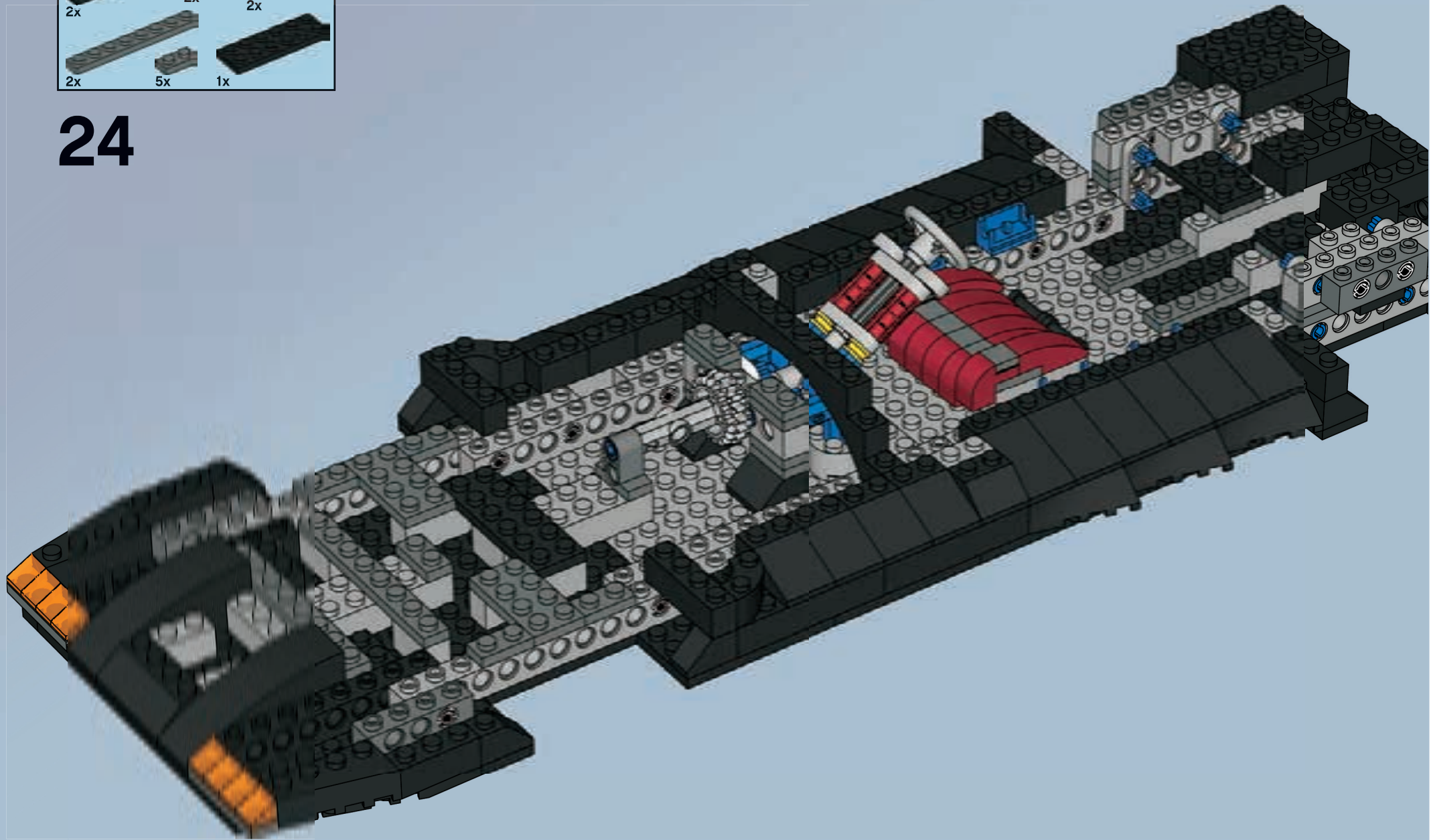



25

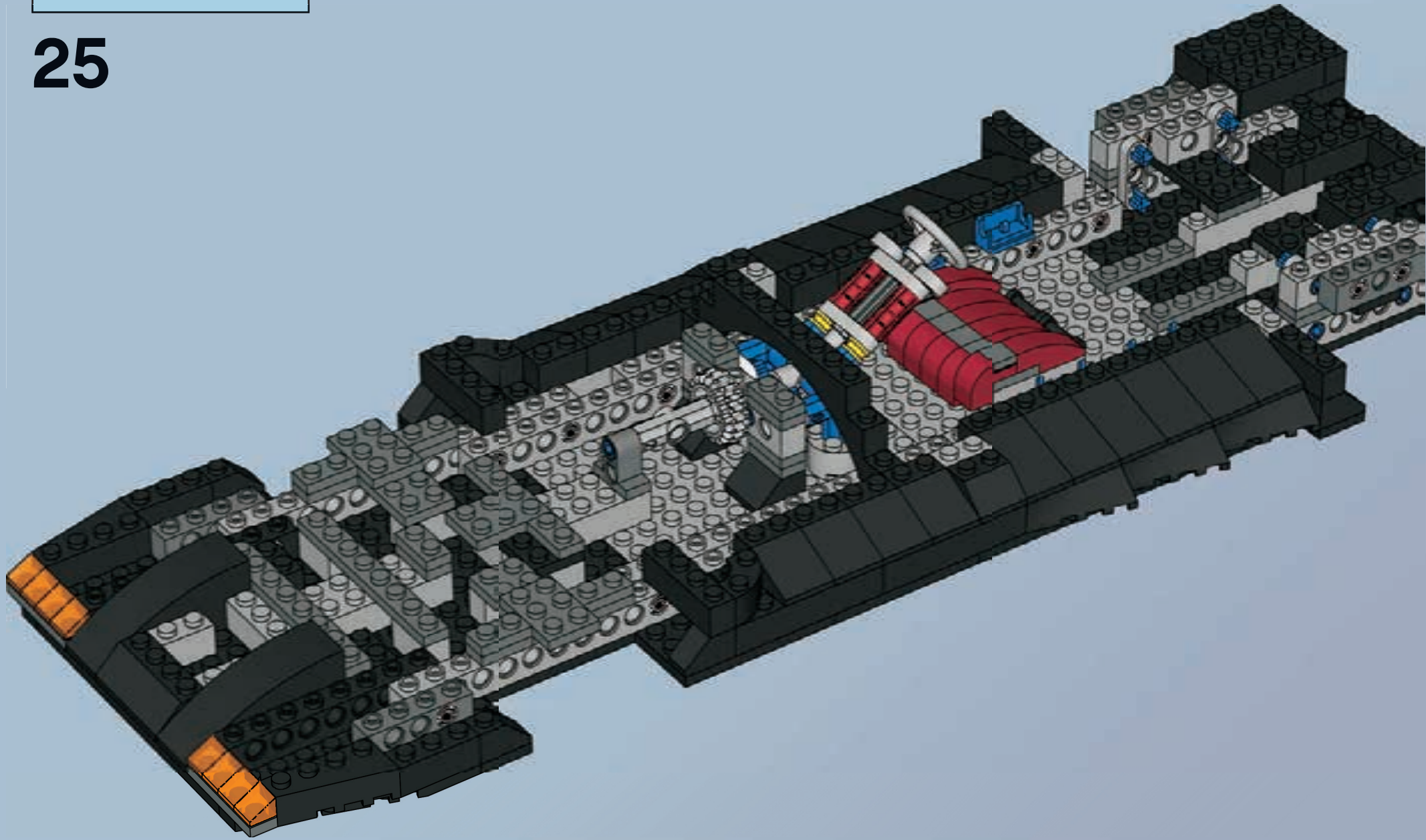

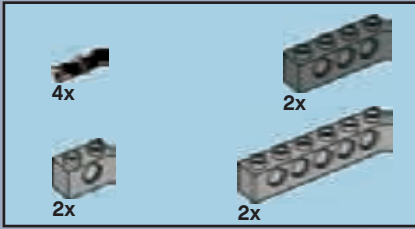

26

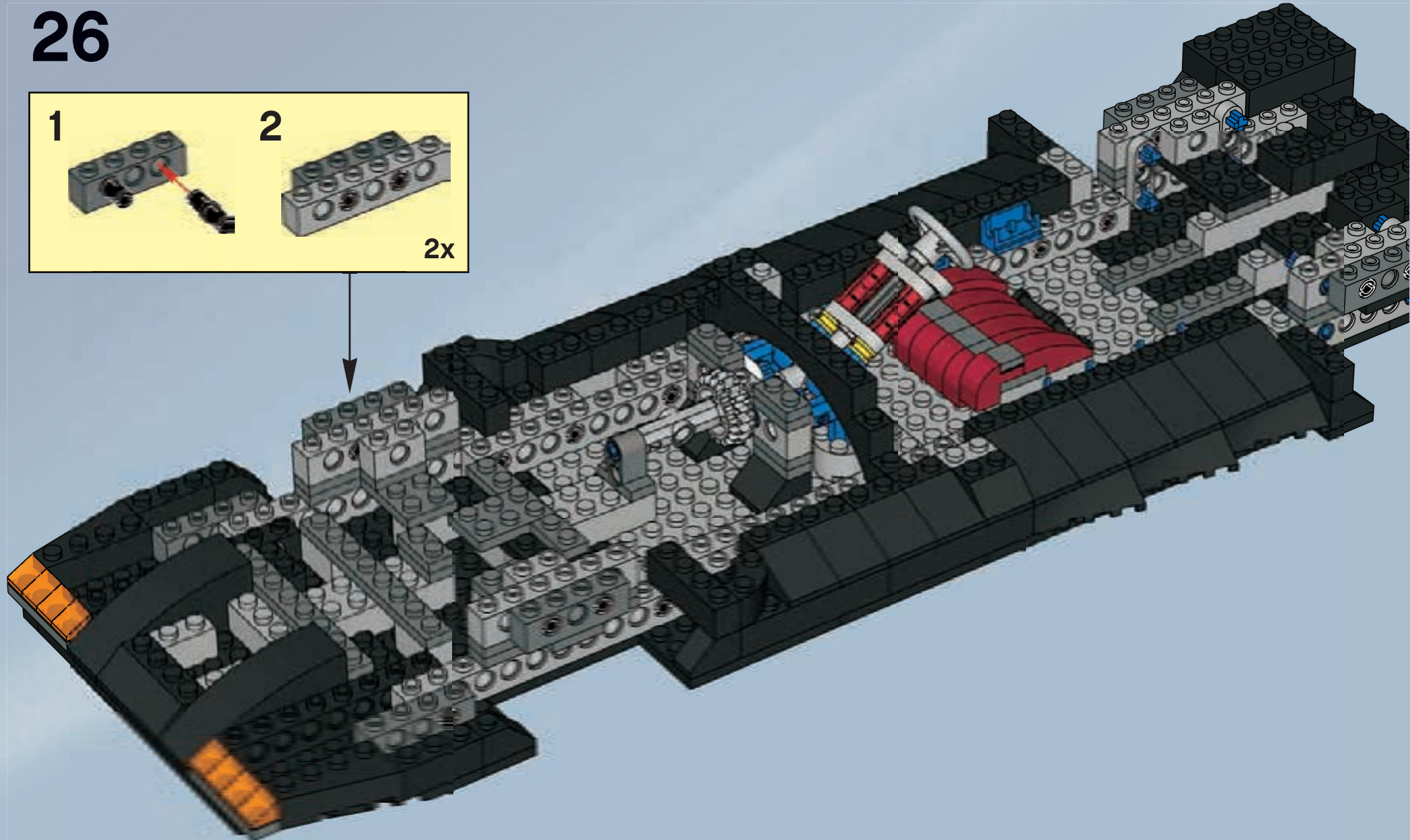
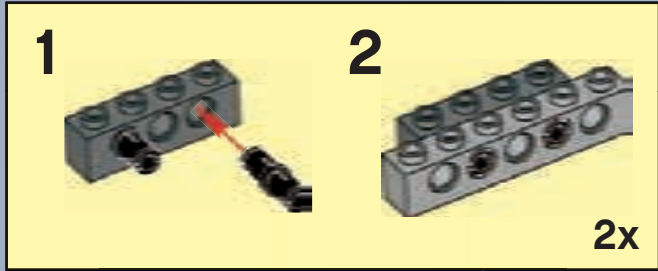



27

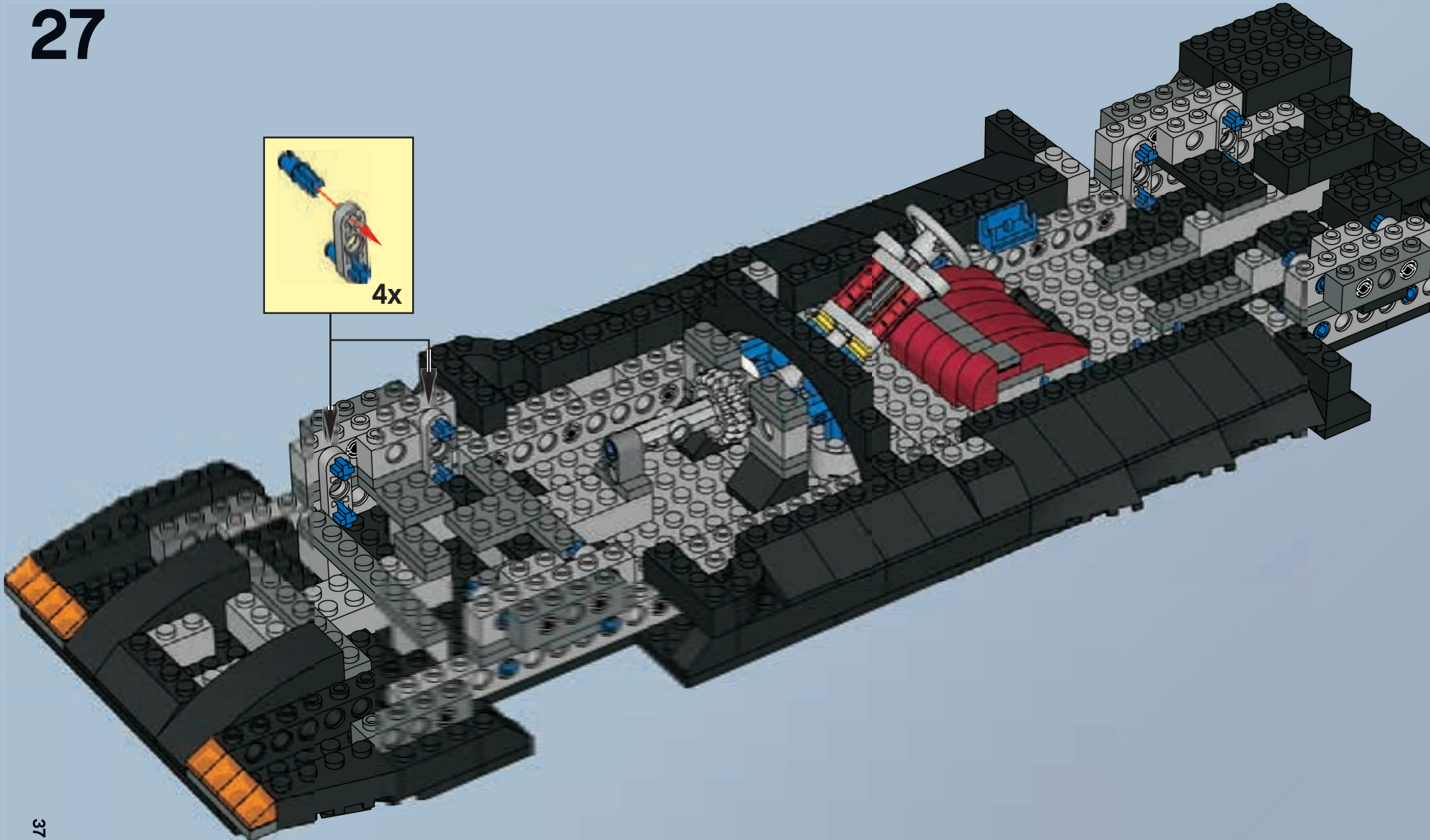



28

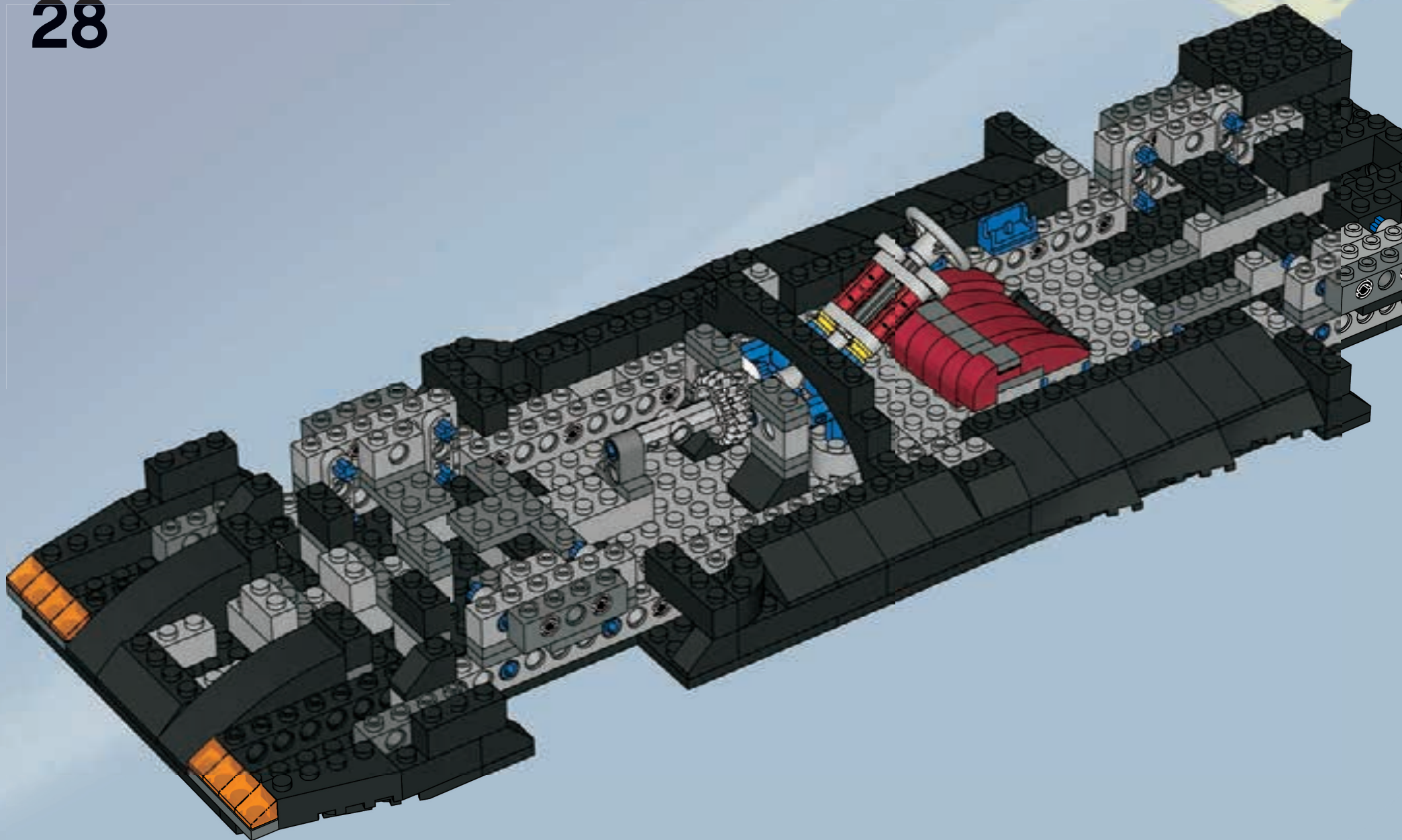

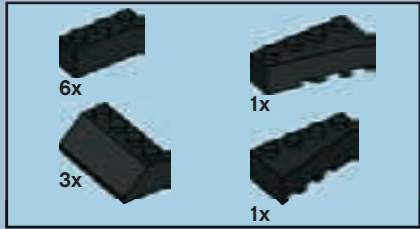

29

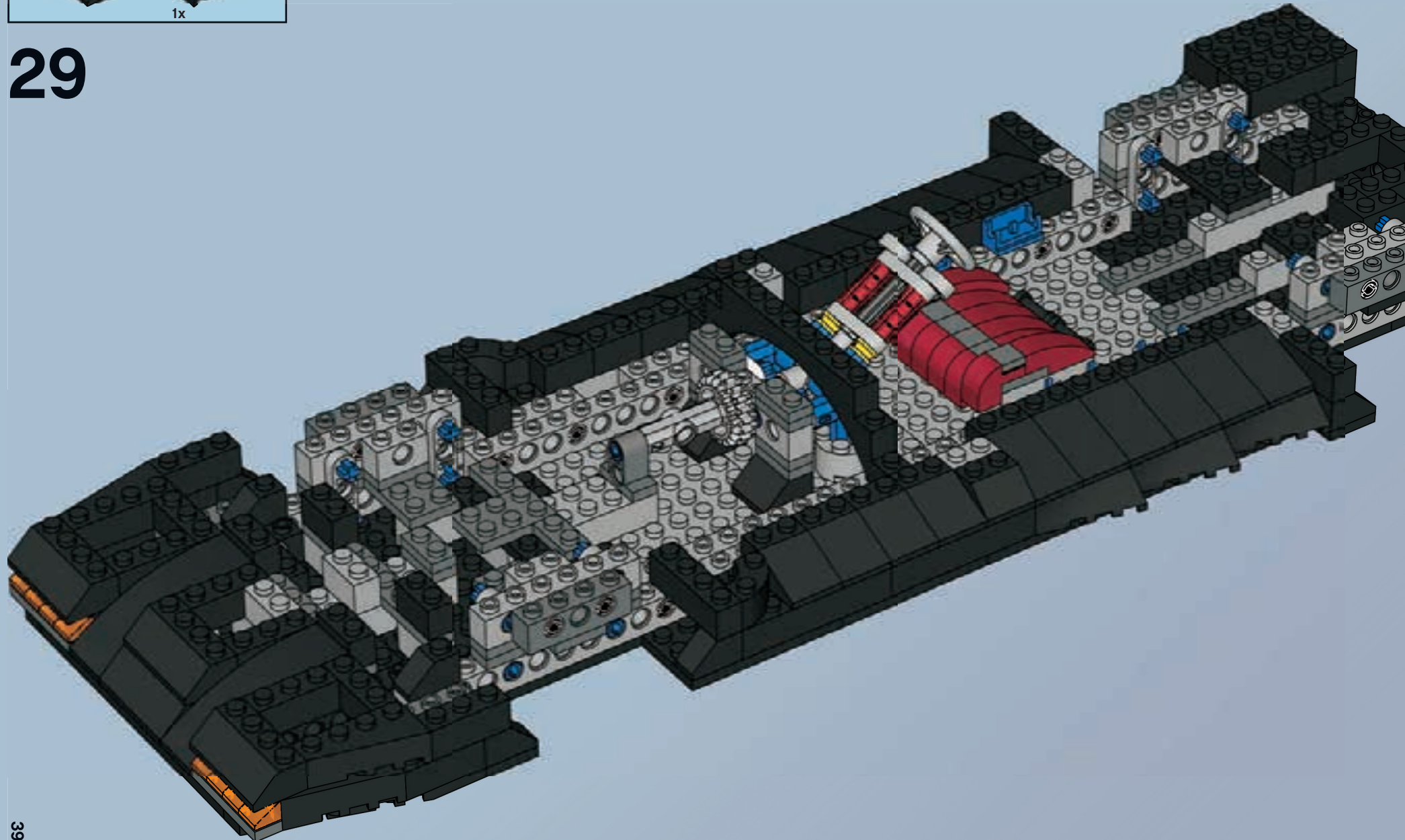

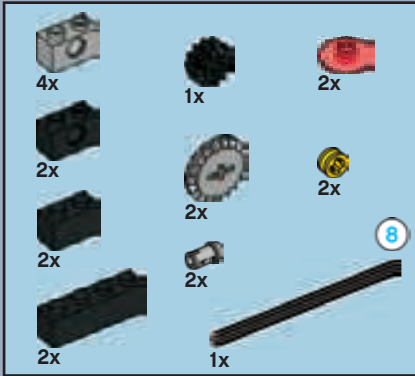

30

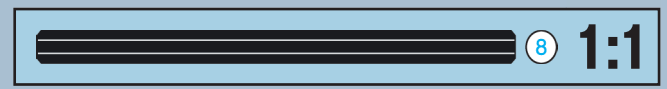
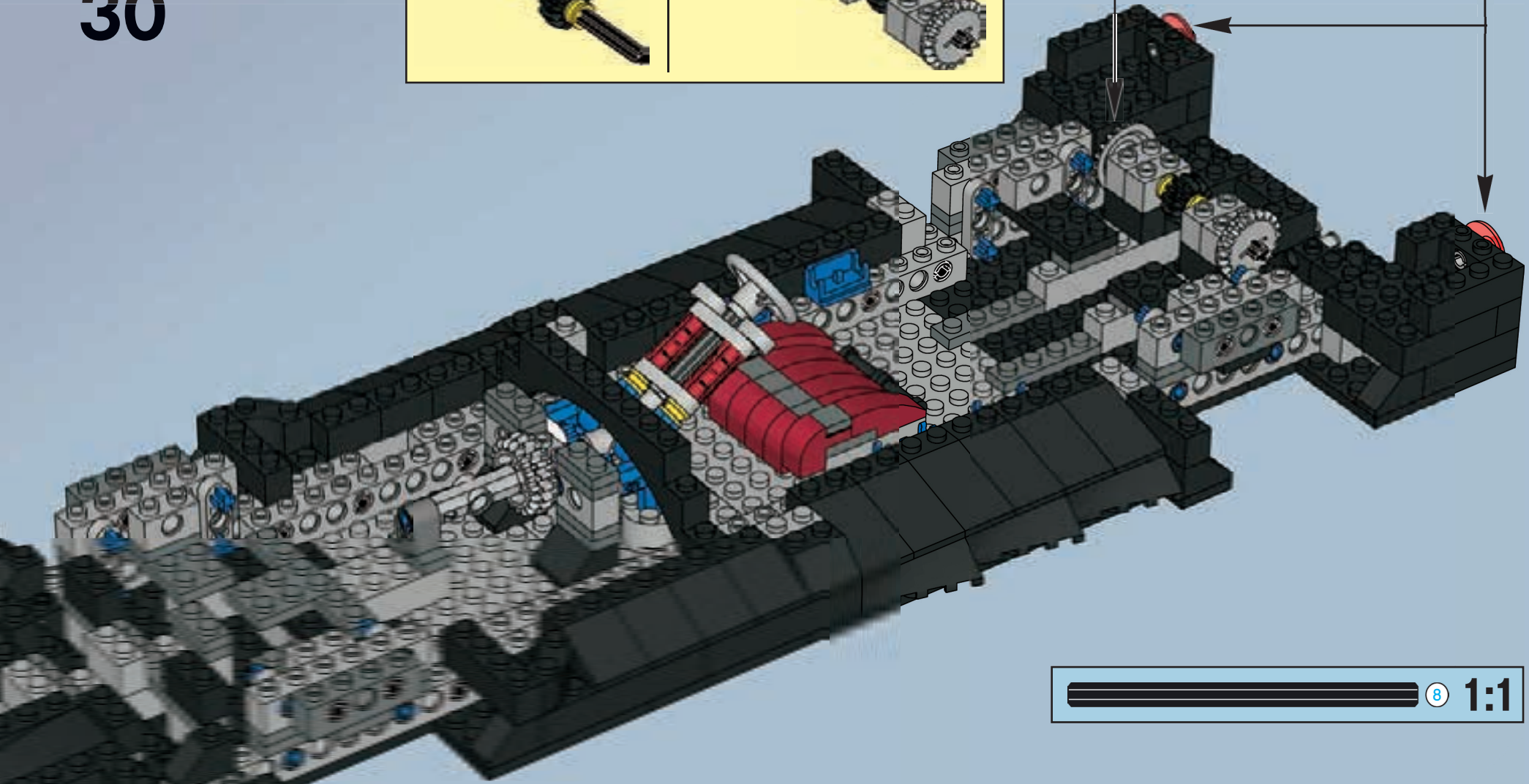
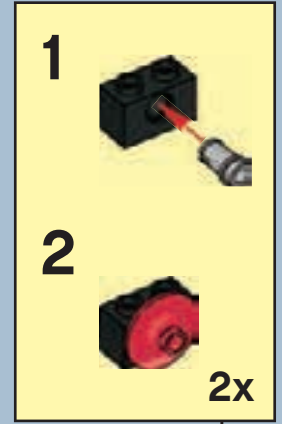
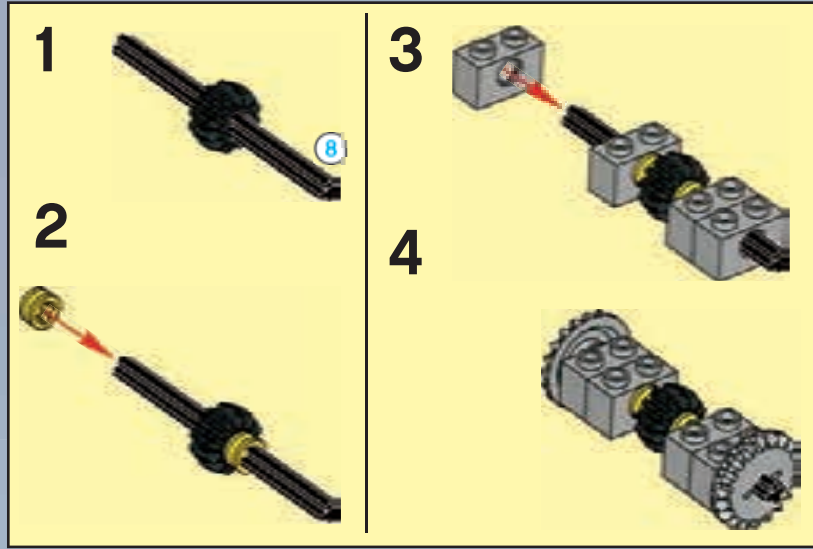

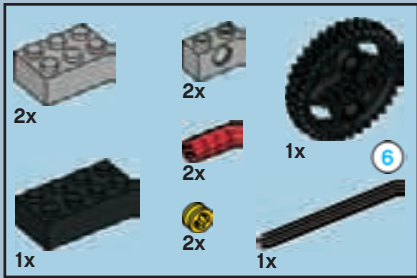

31

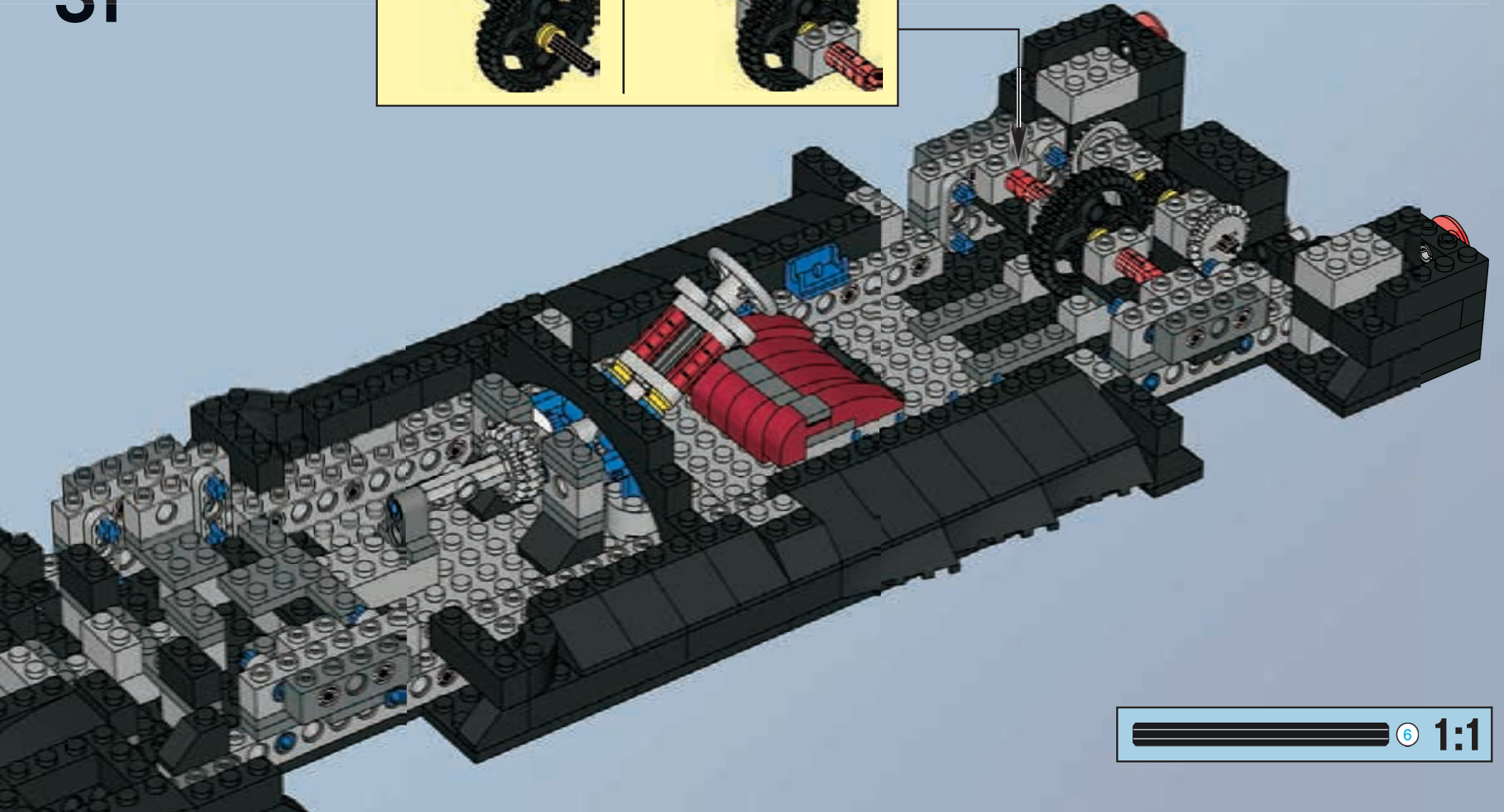
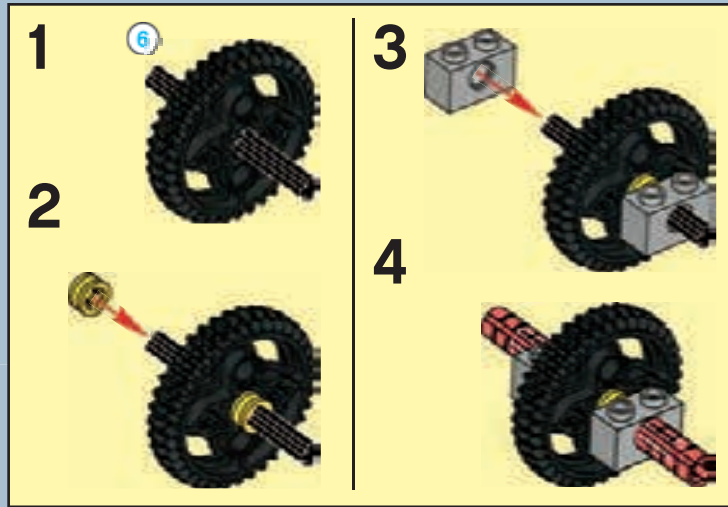

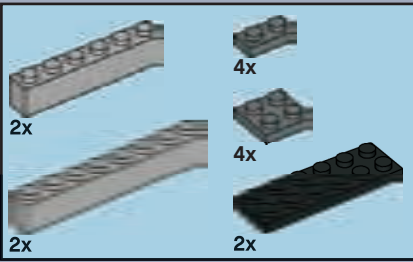

32

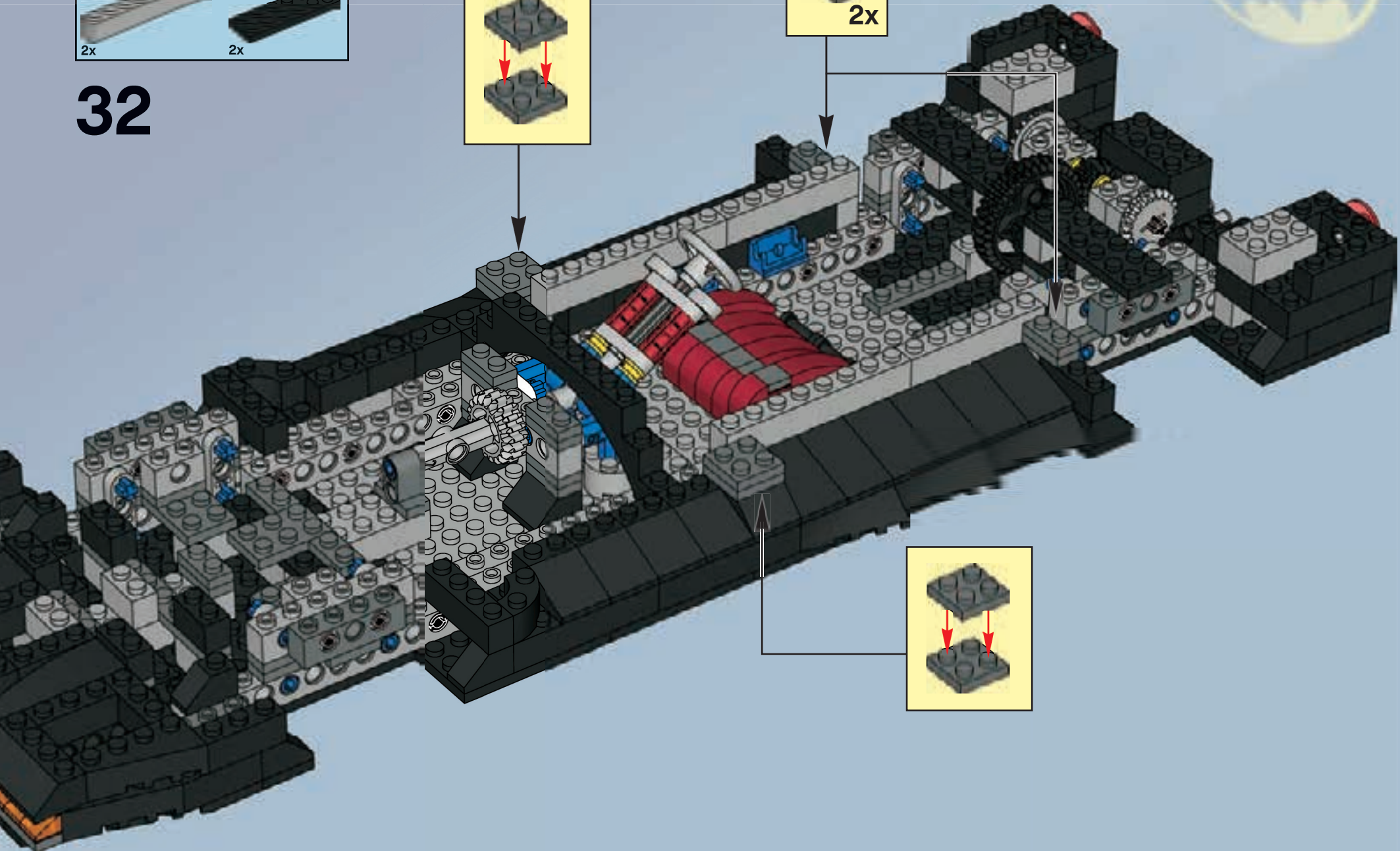
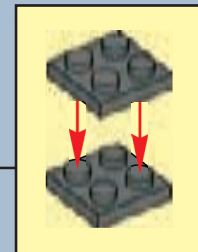
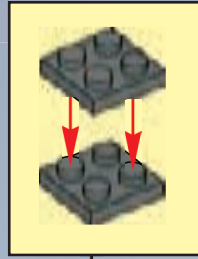

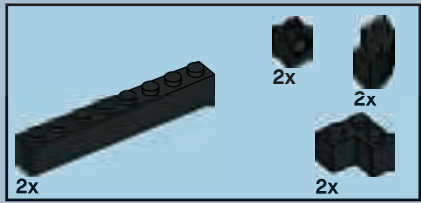

33

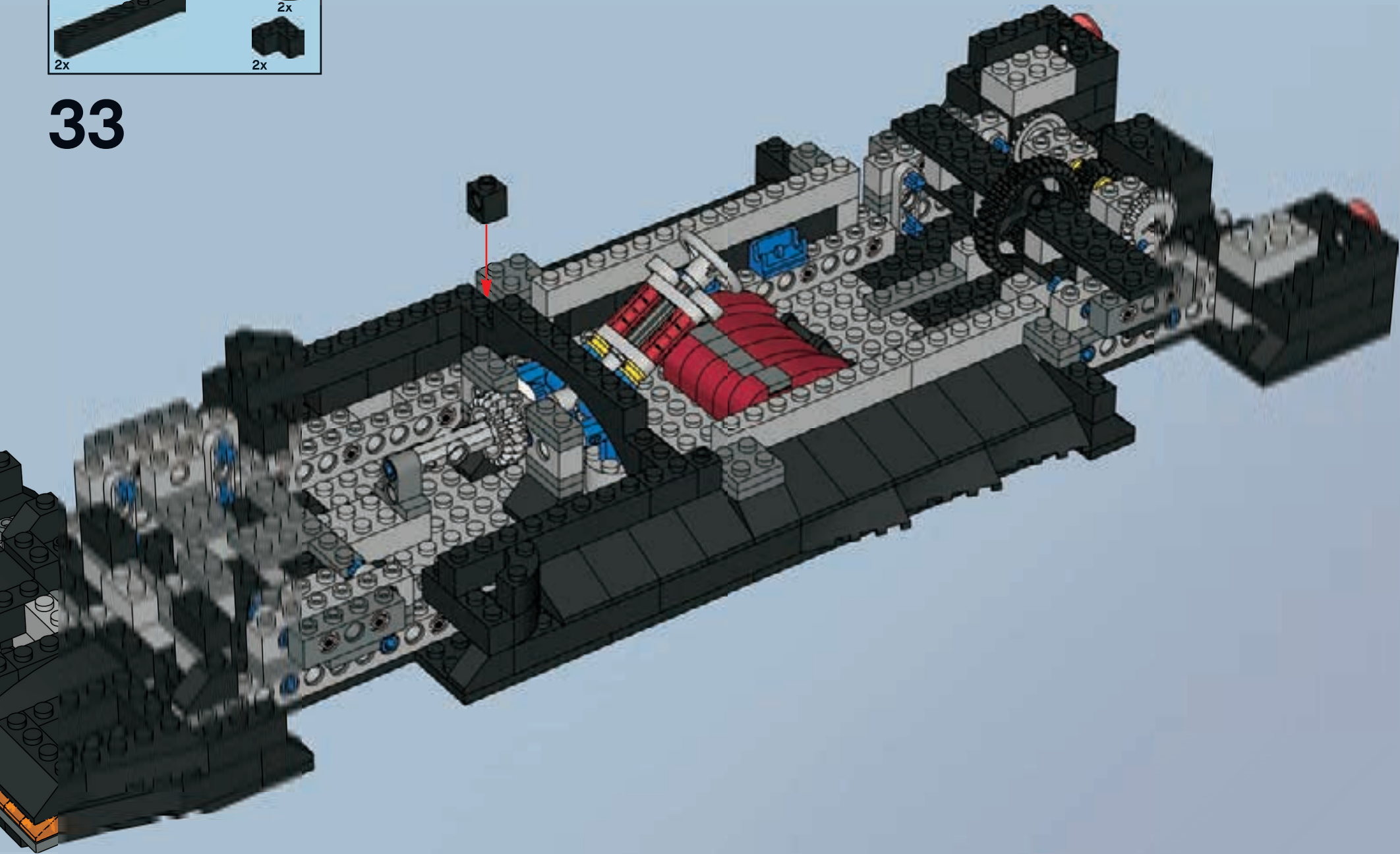

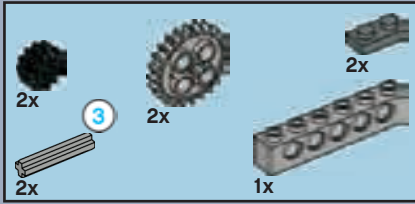

34

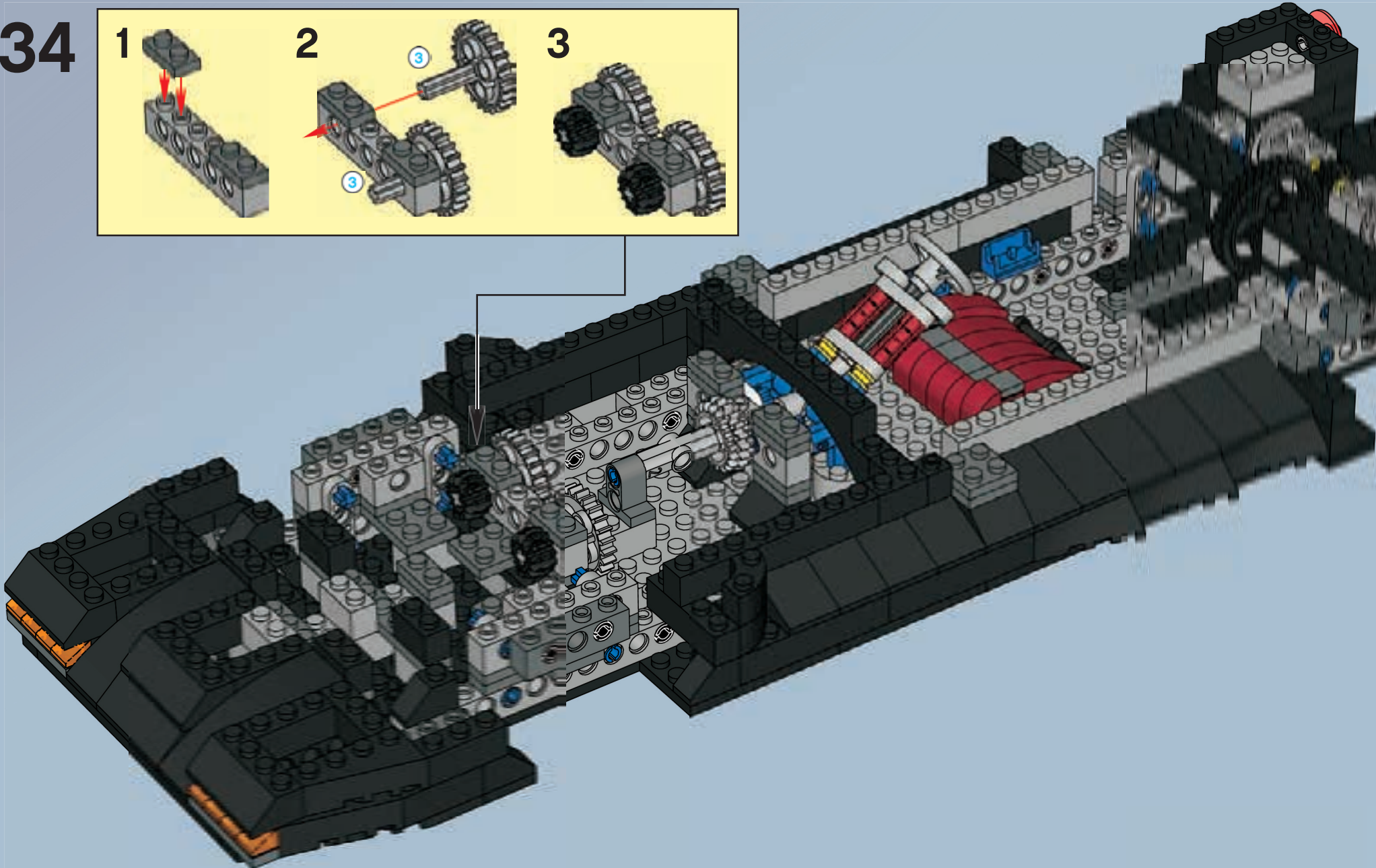
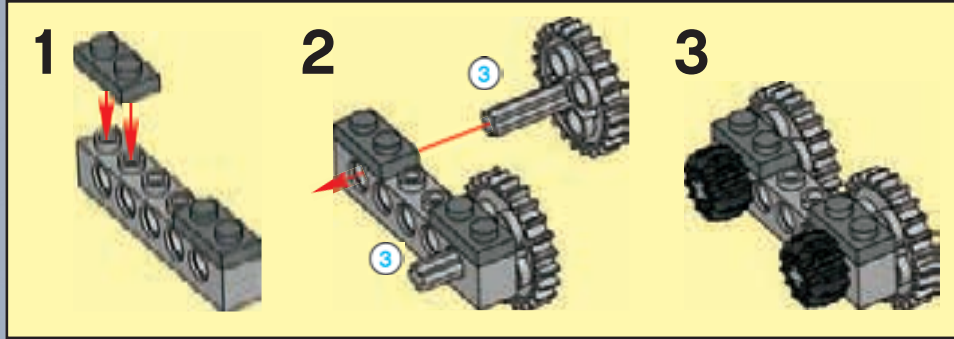



35

1

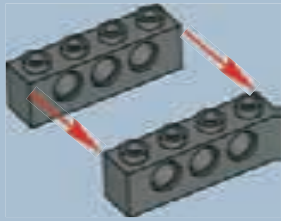

2

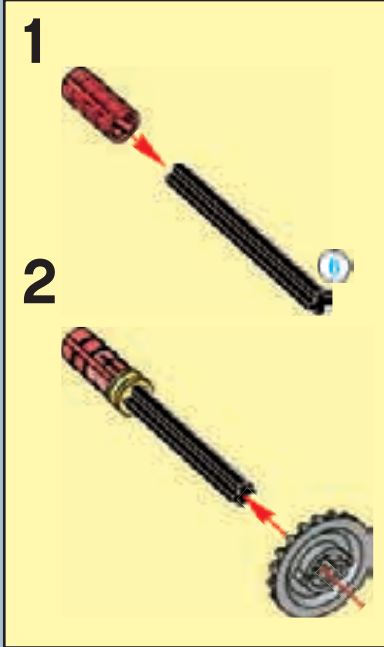

3



4

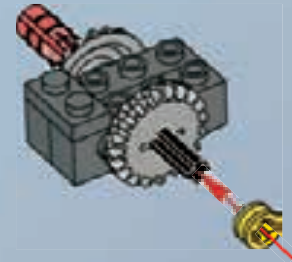

5

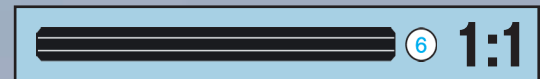

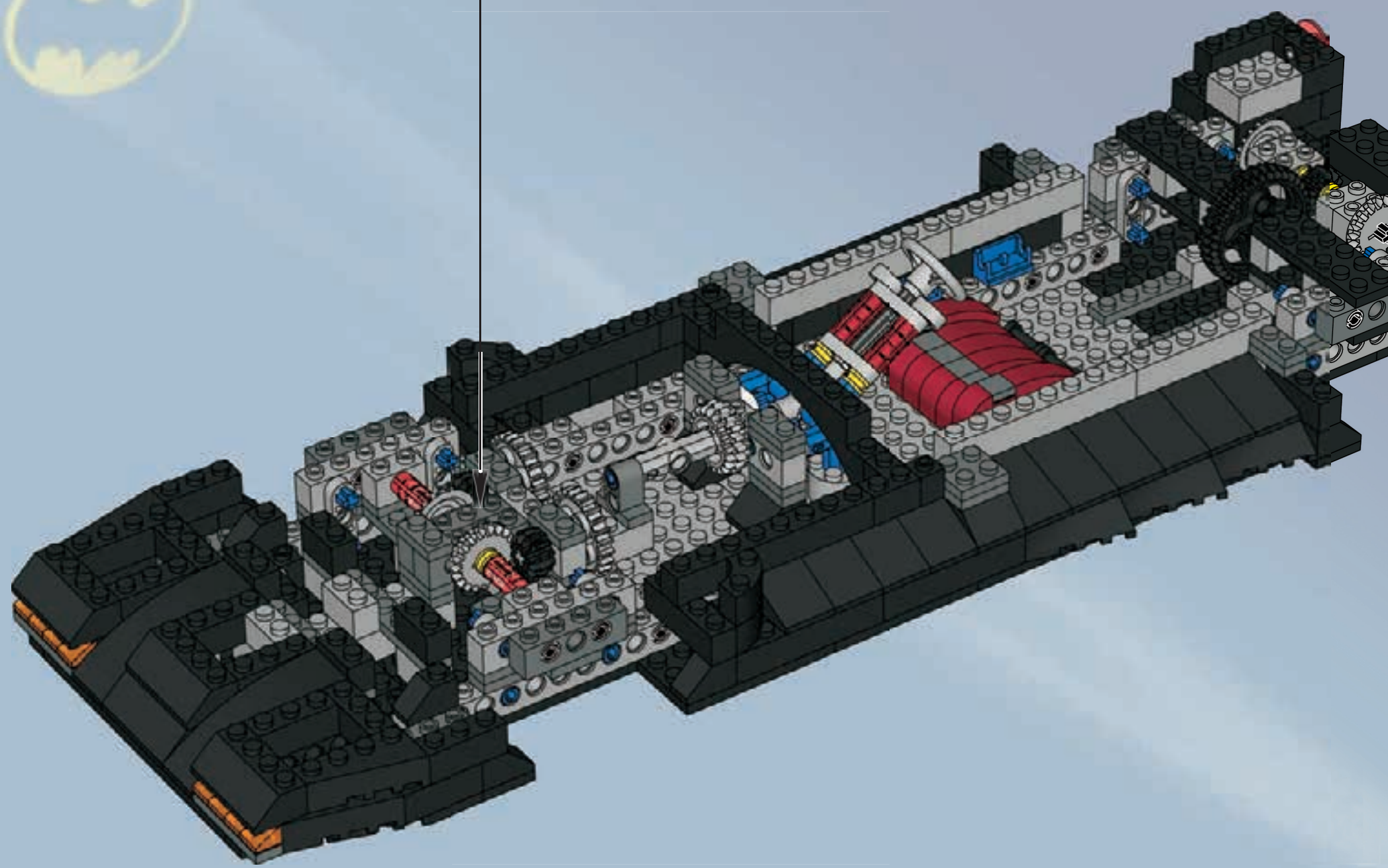

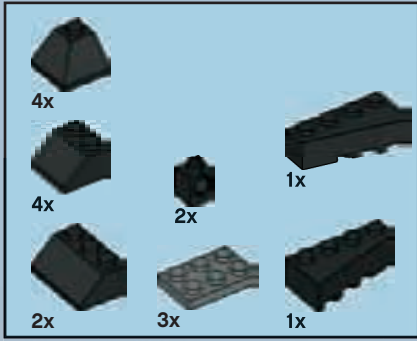

36

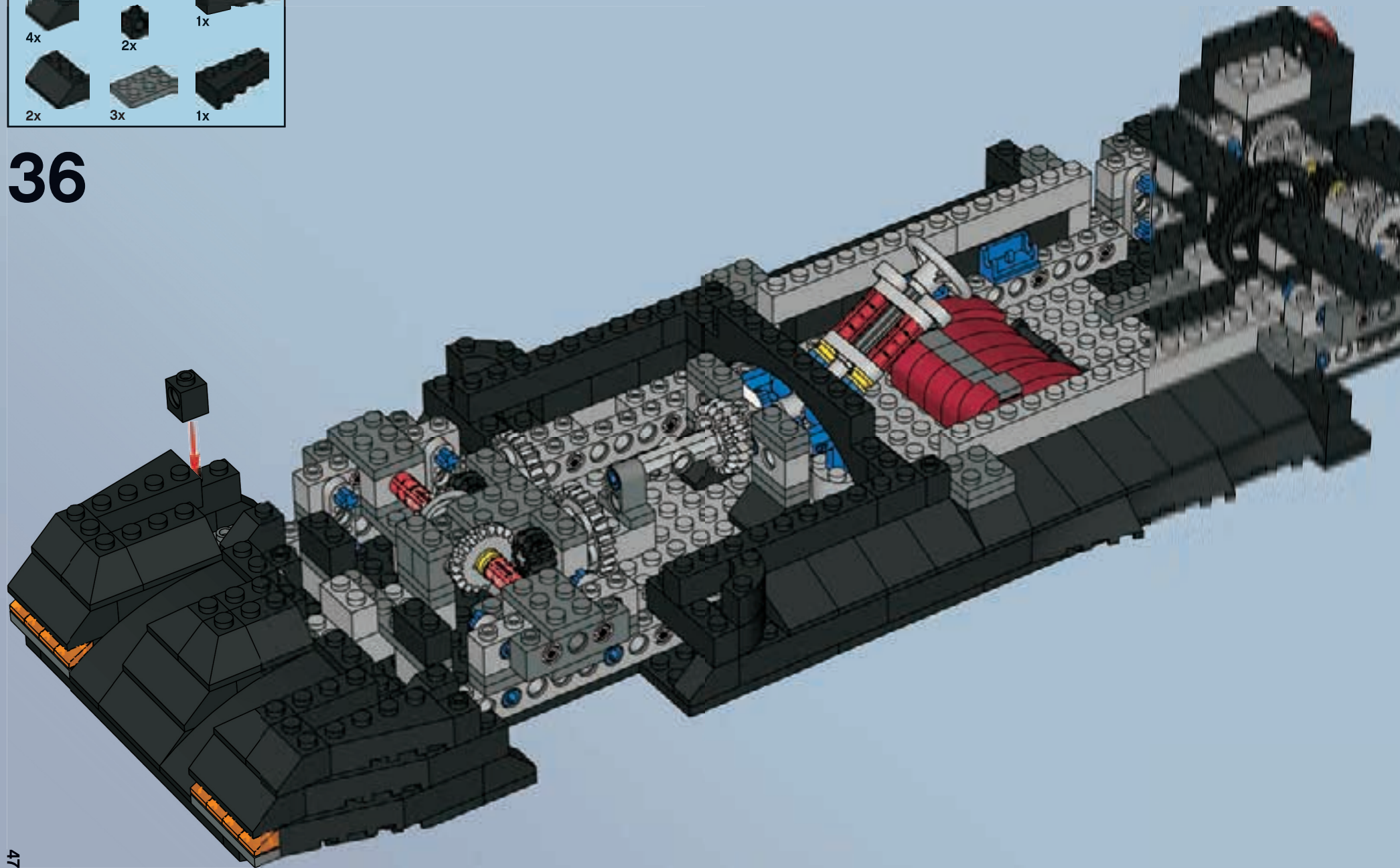



37

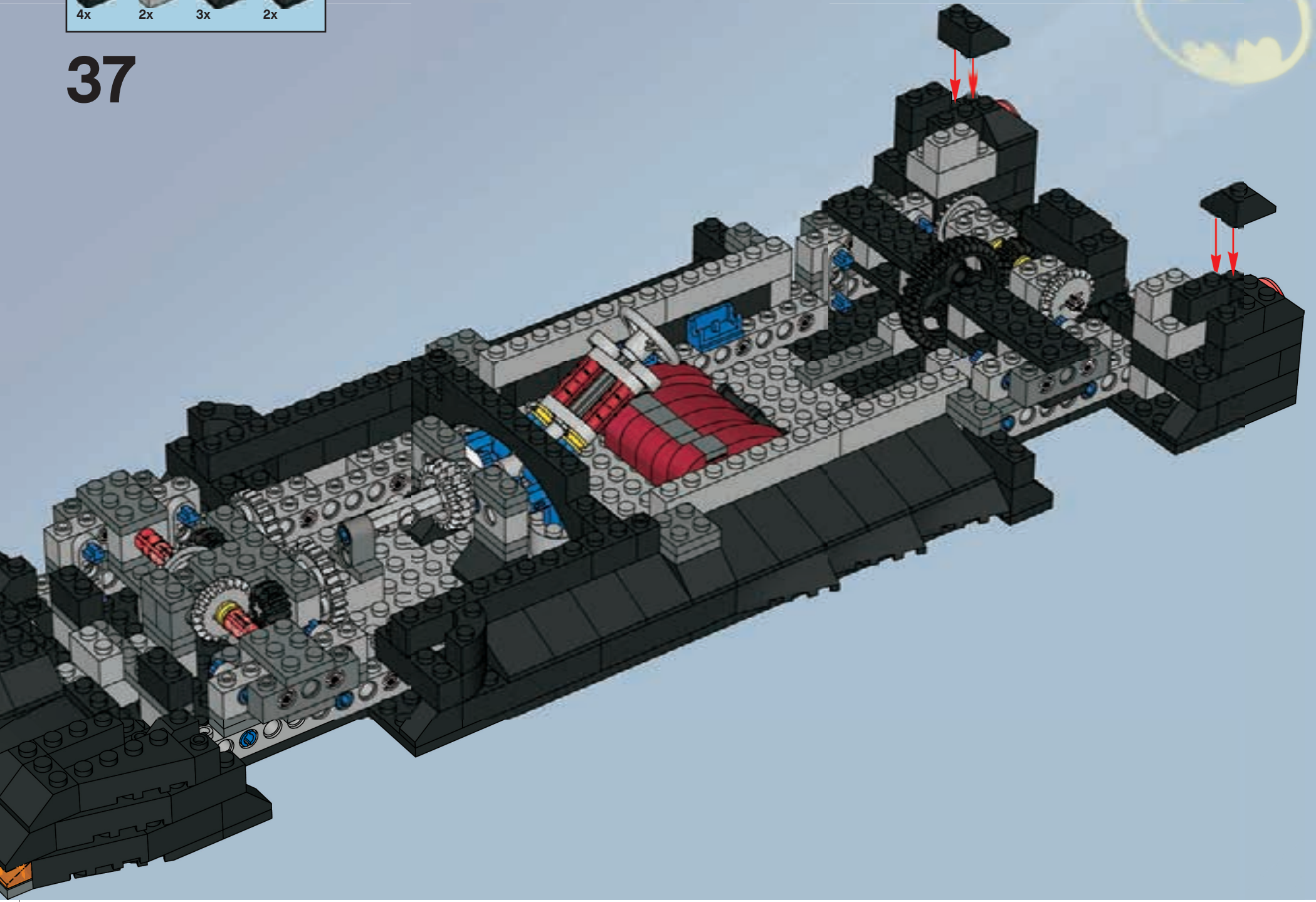

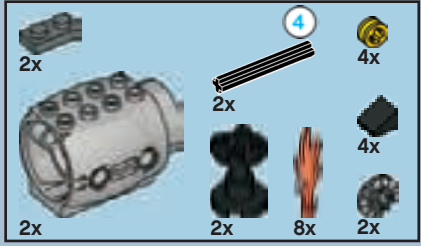

38

1



2



3



4



5

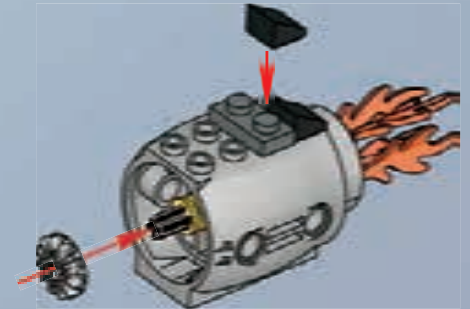

2x



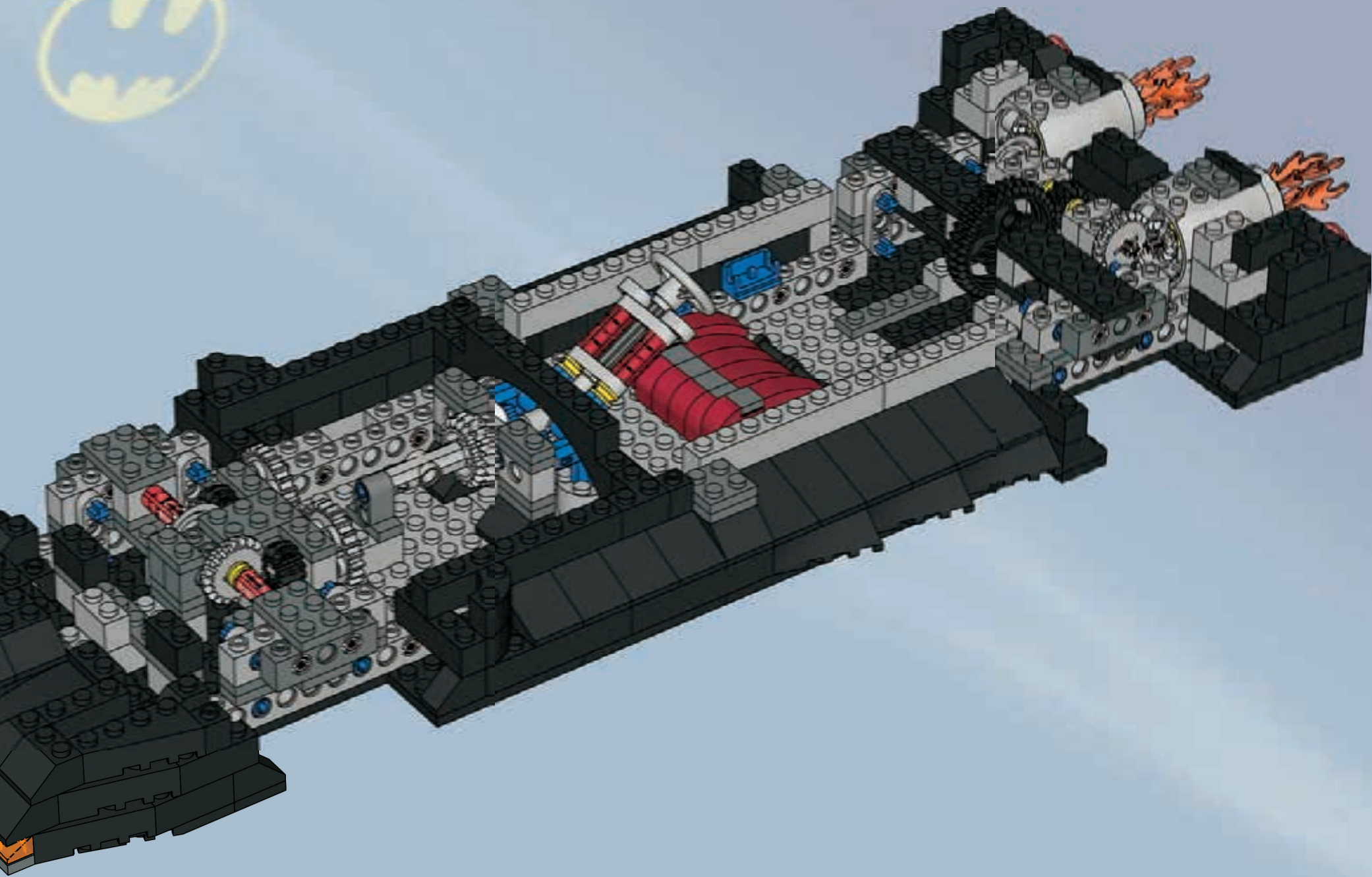

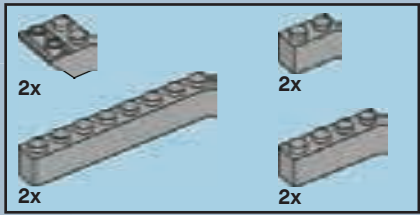

39

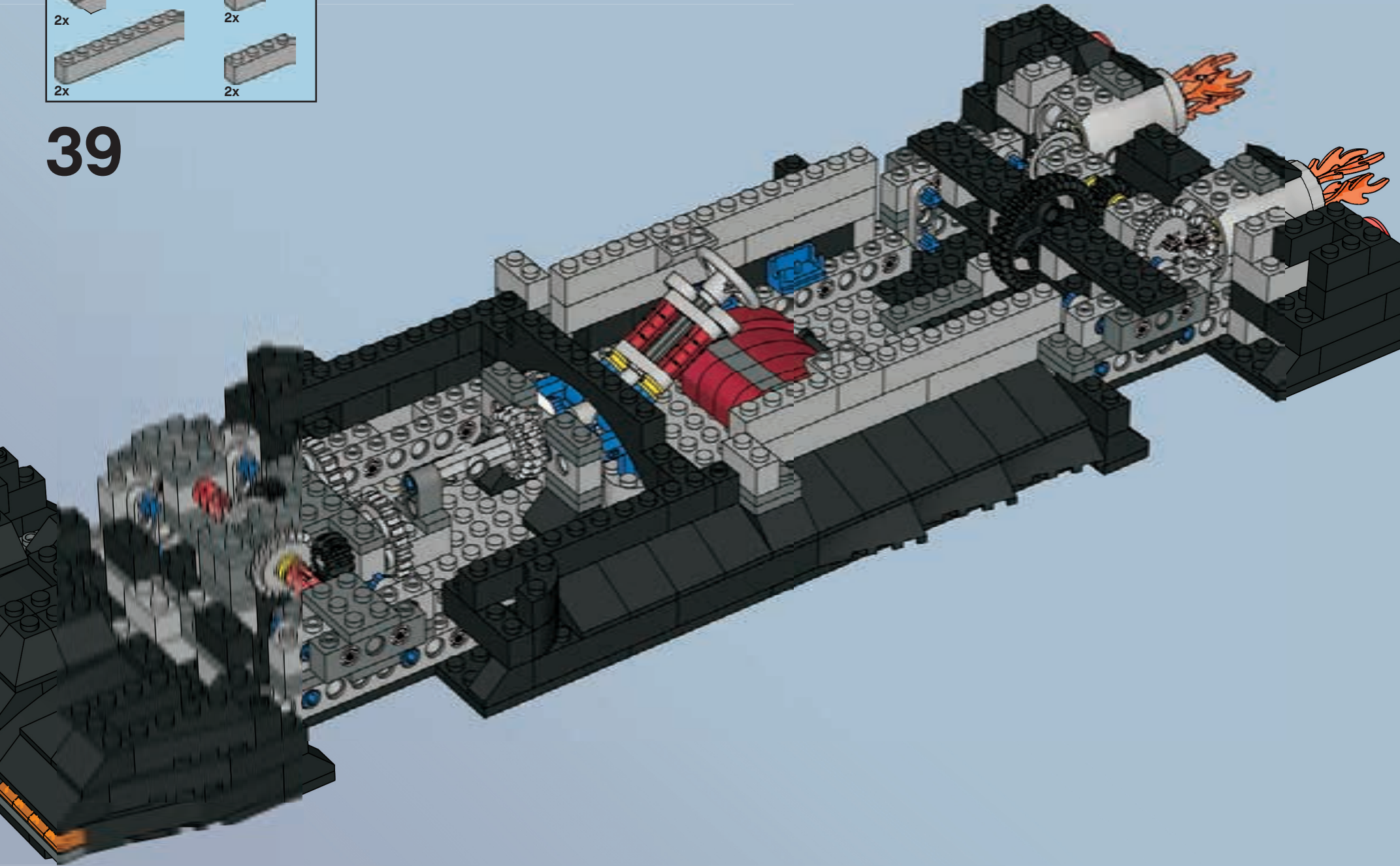

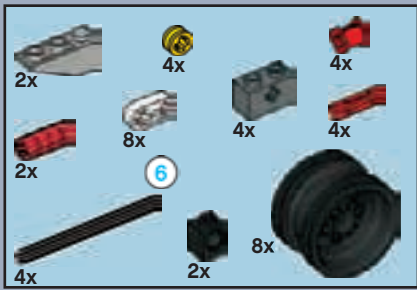

40

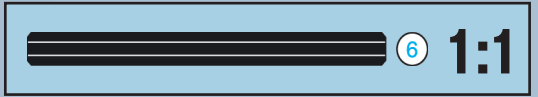
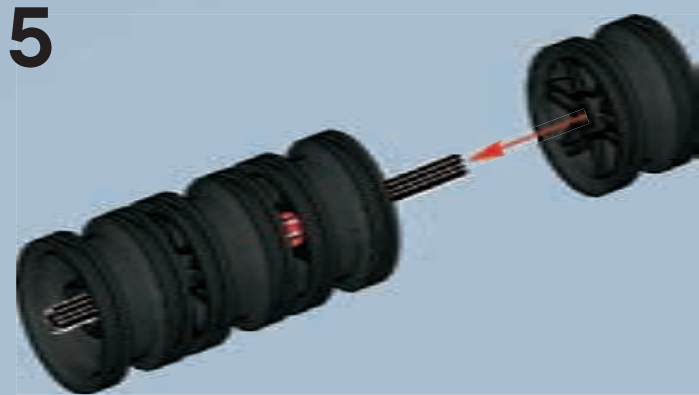
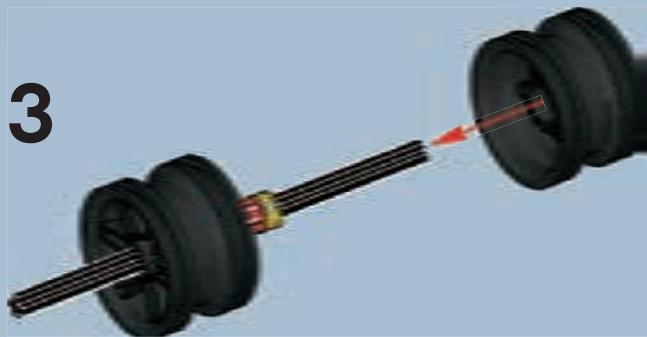

2x

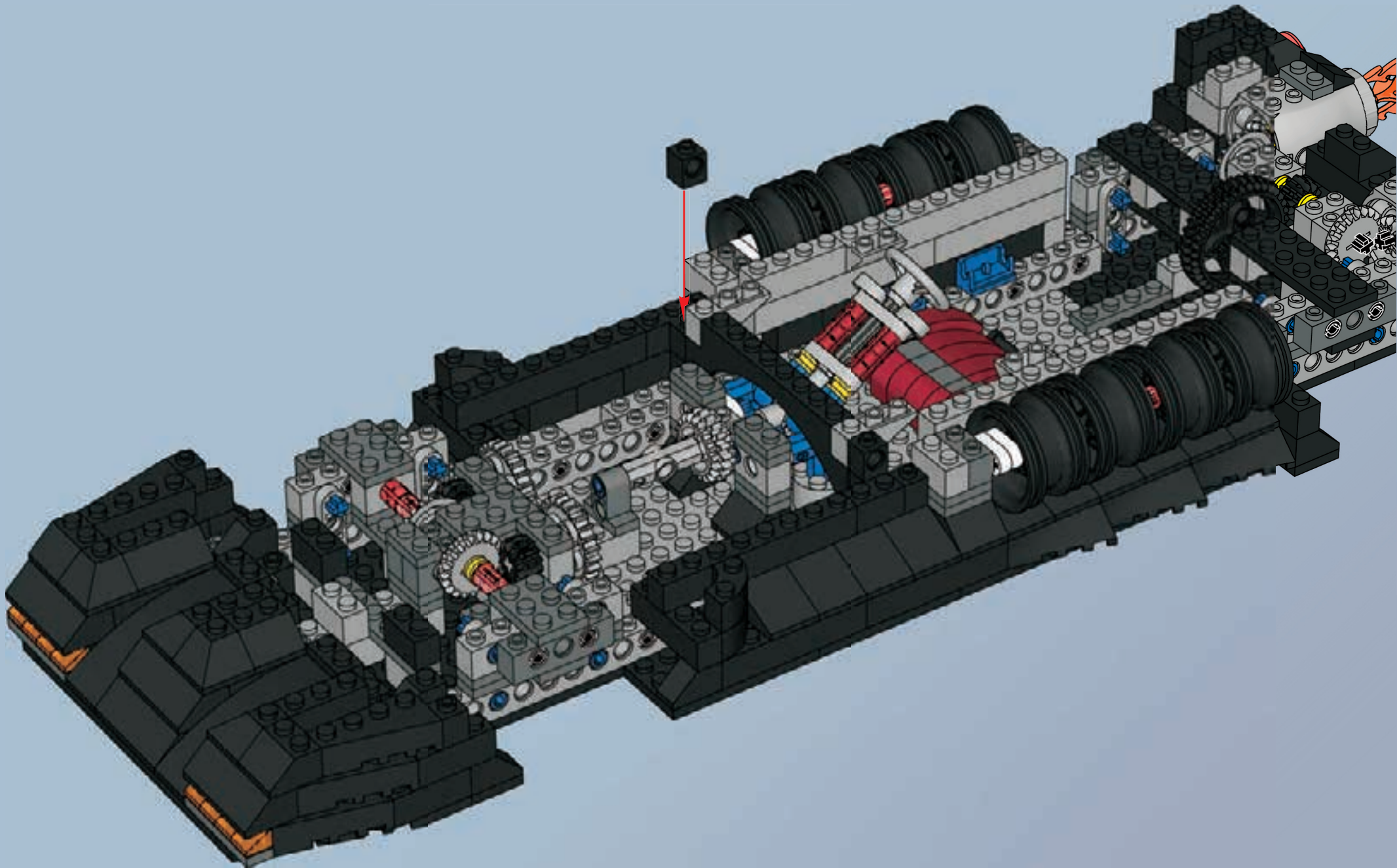



41

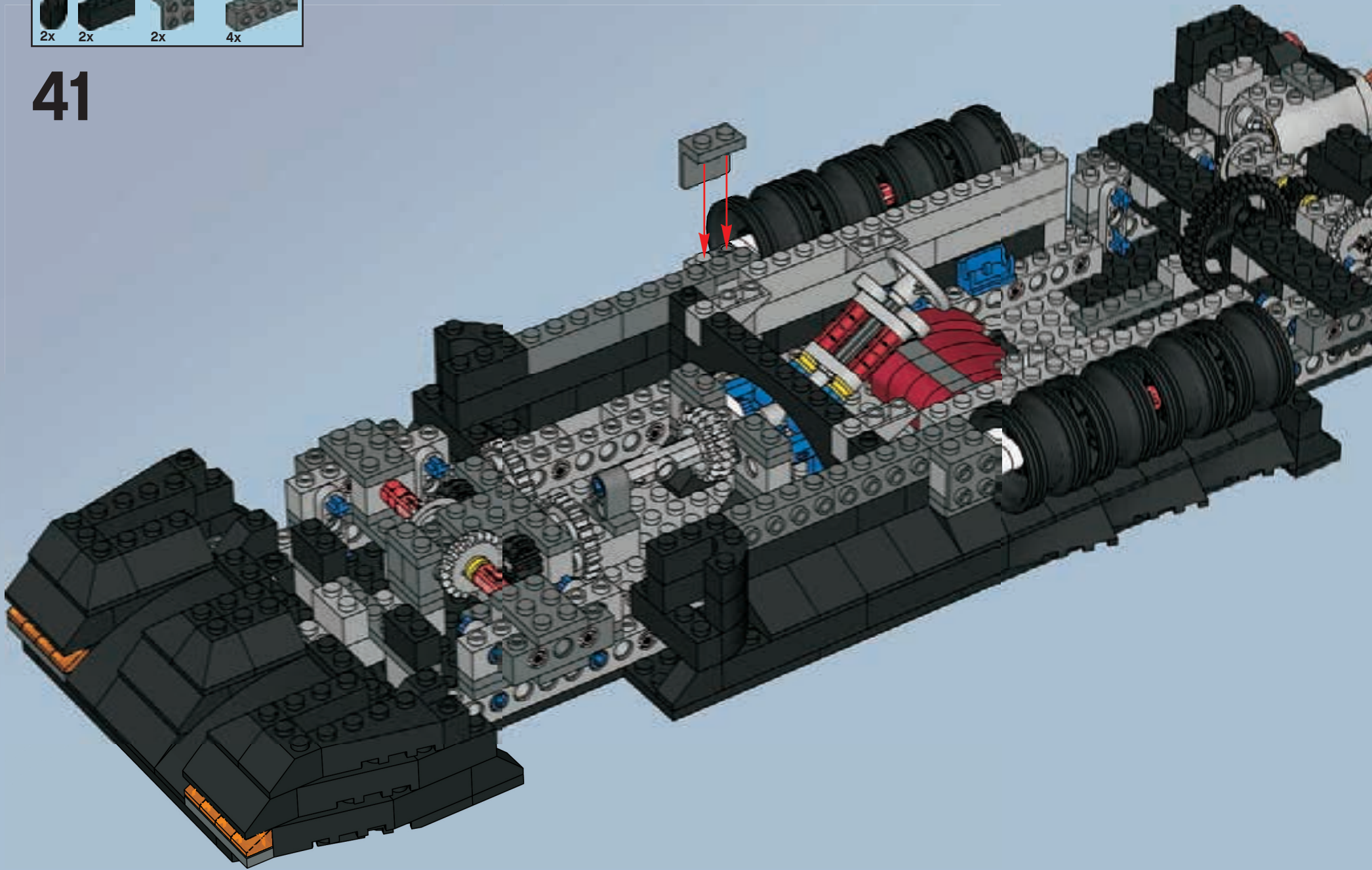

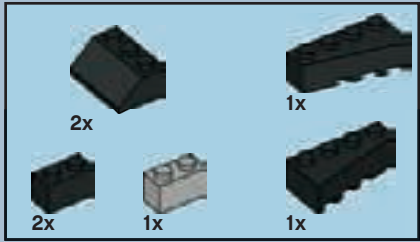

42

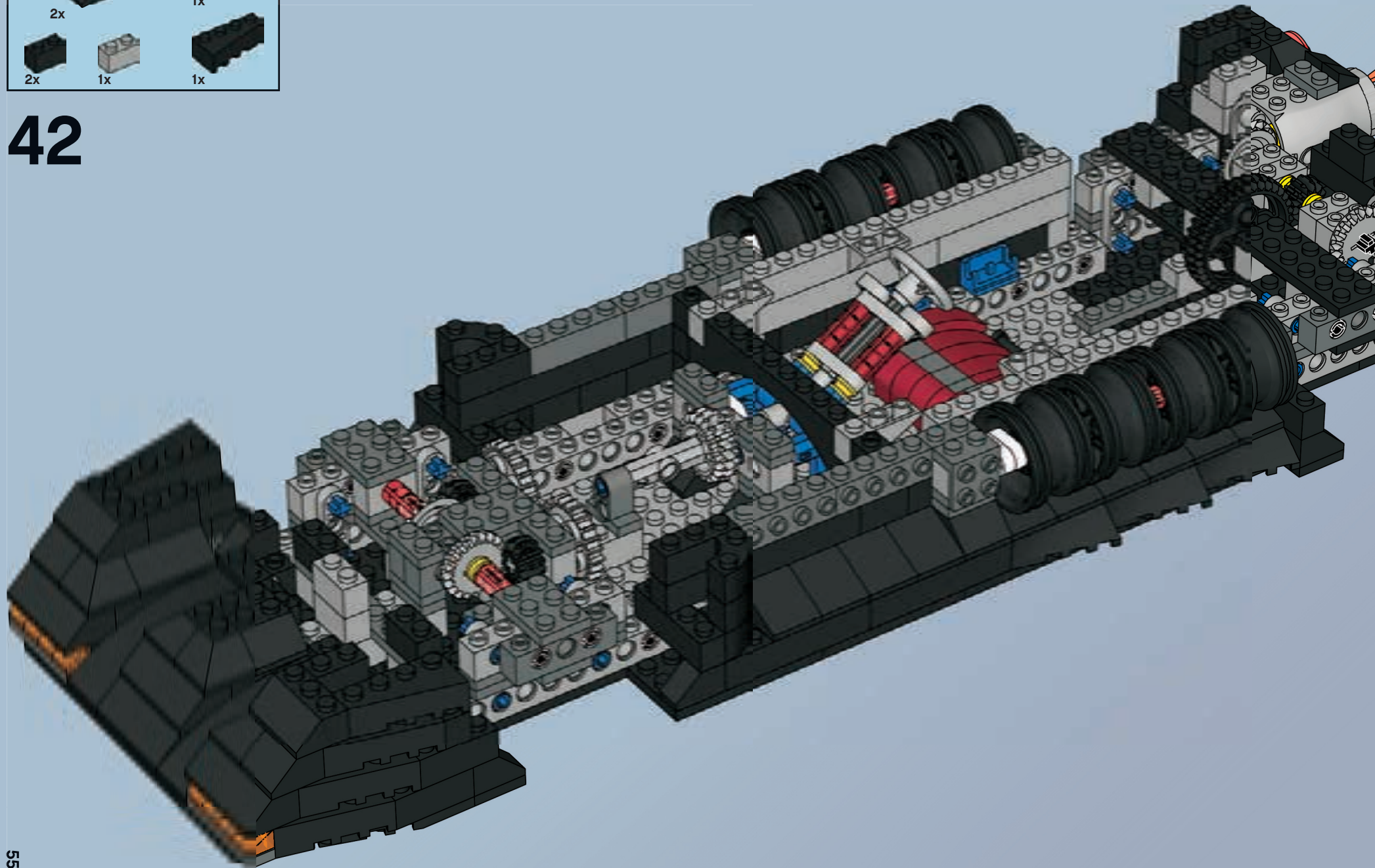



43

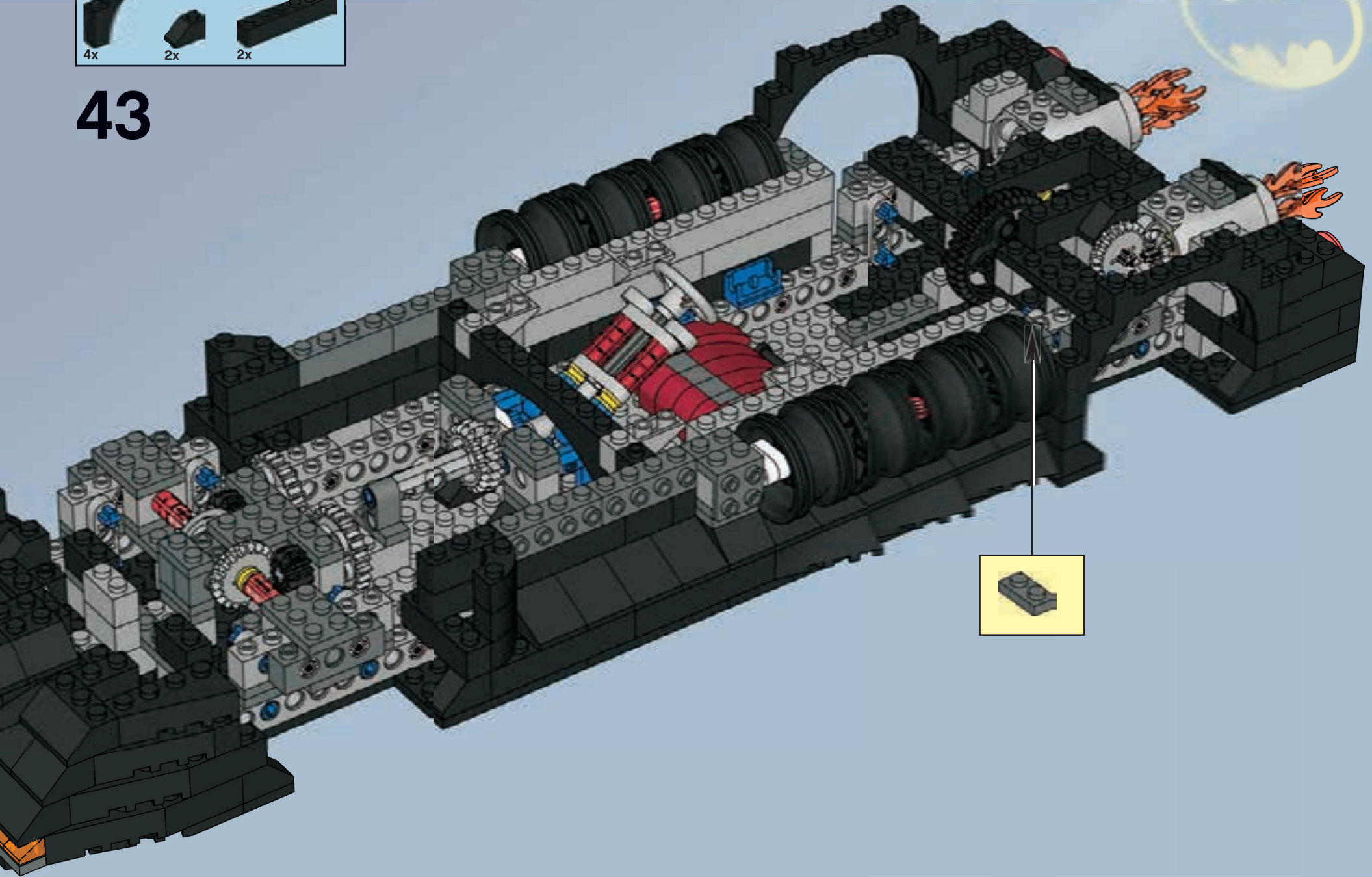

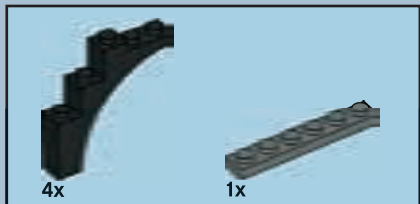

44

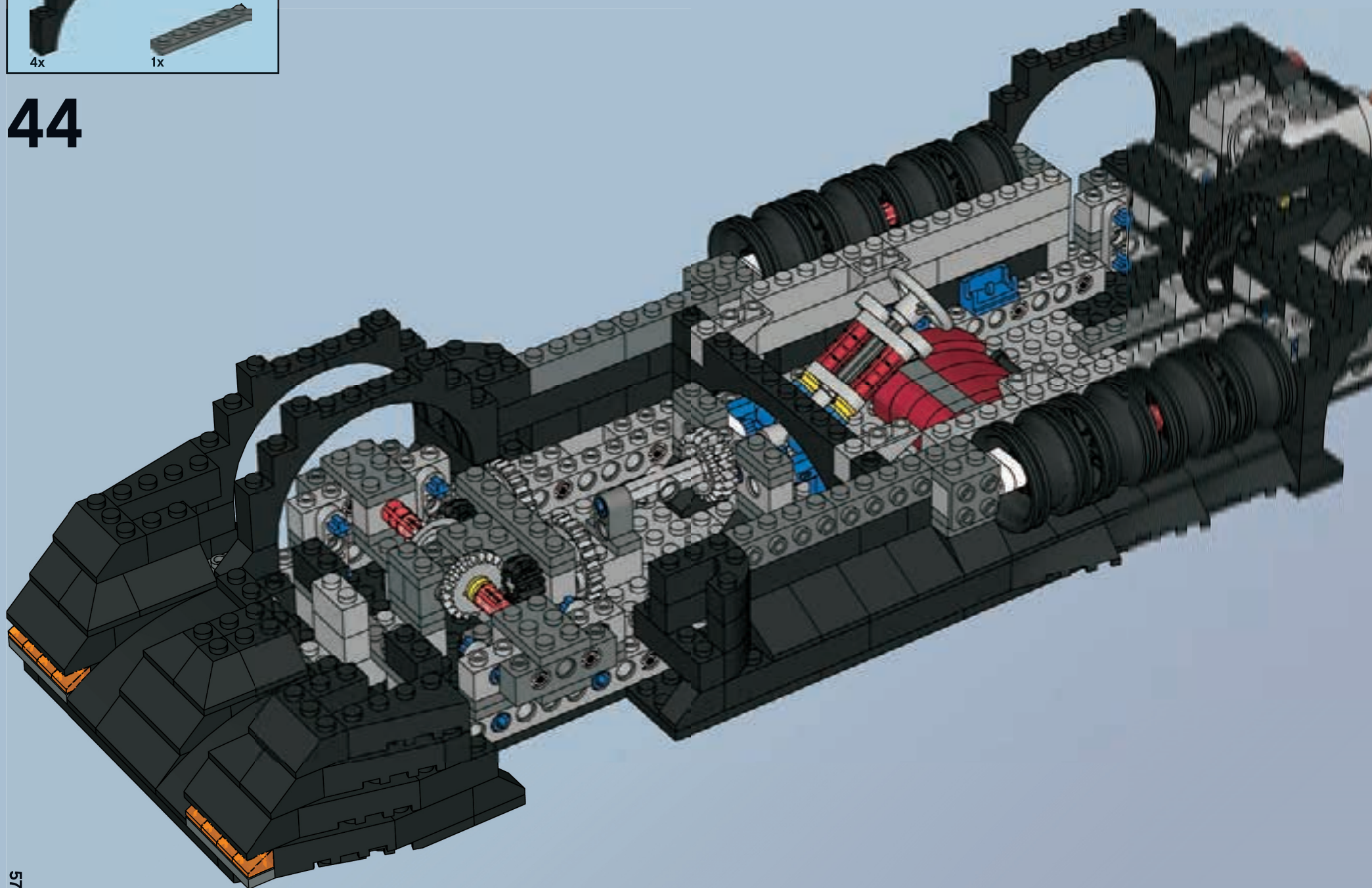

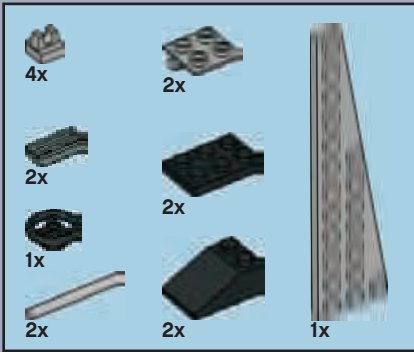

45

1

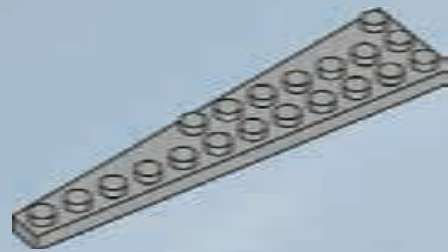

2

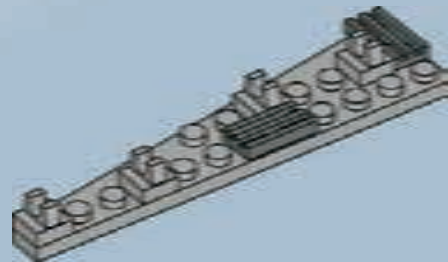

3

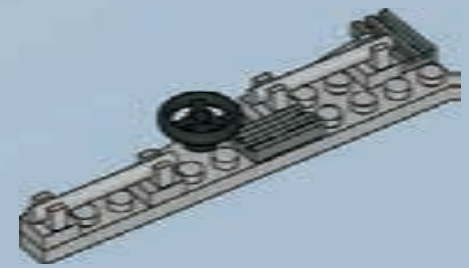

4

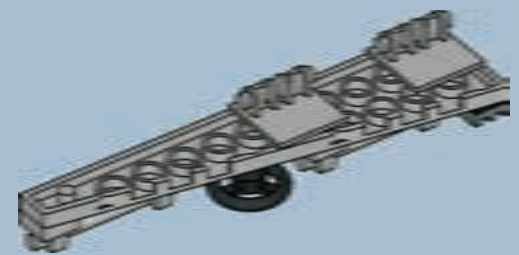

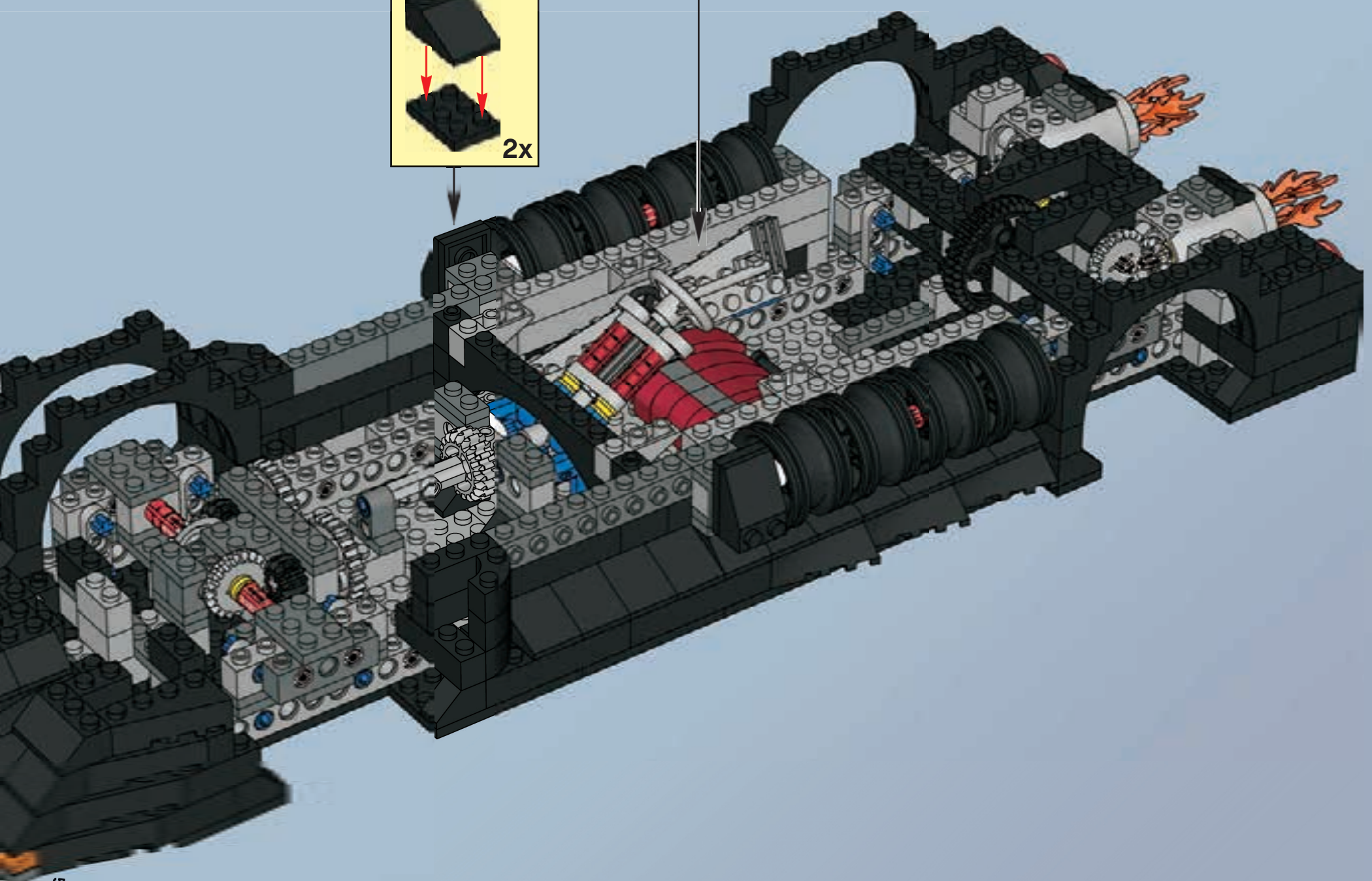
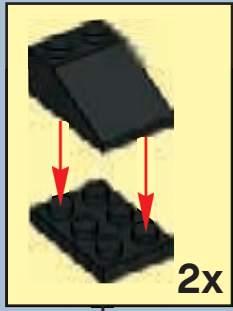

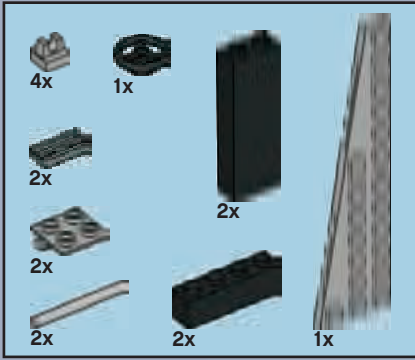

46

1



2



3

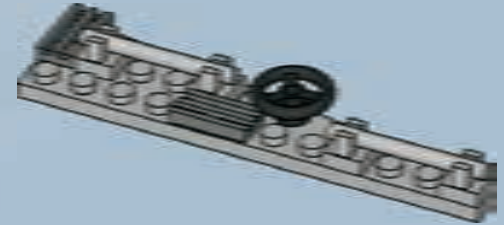

4

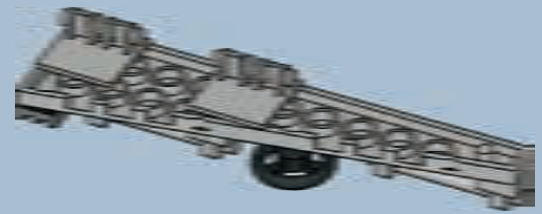

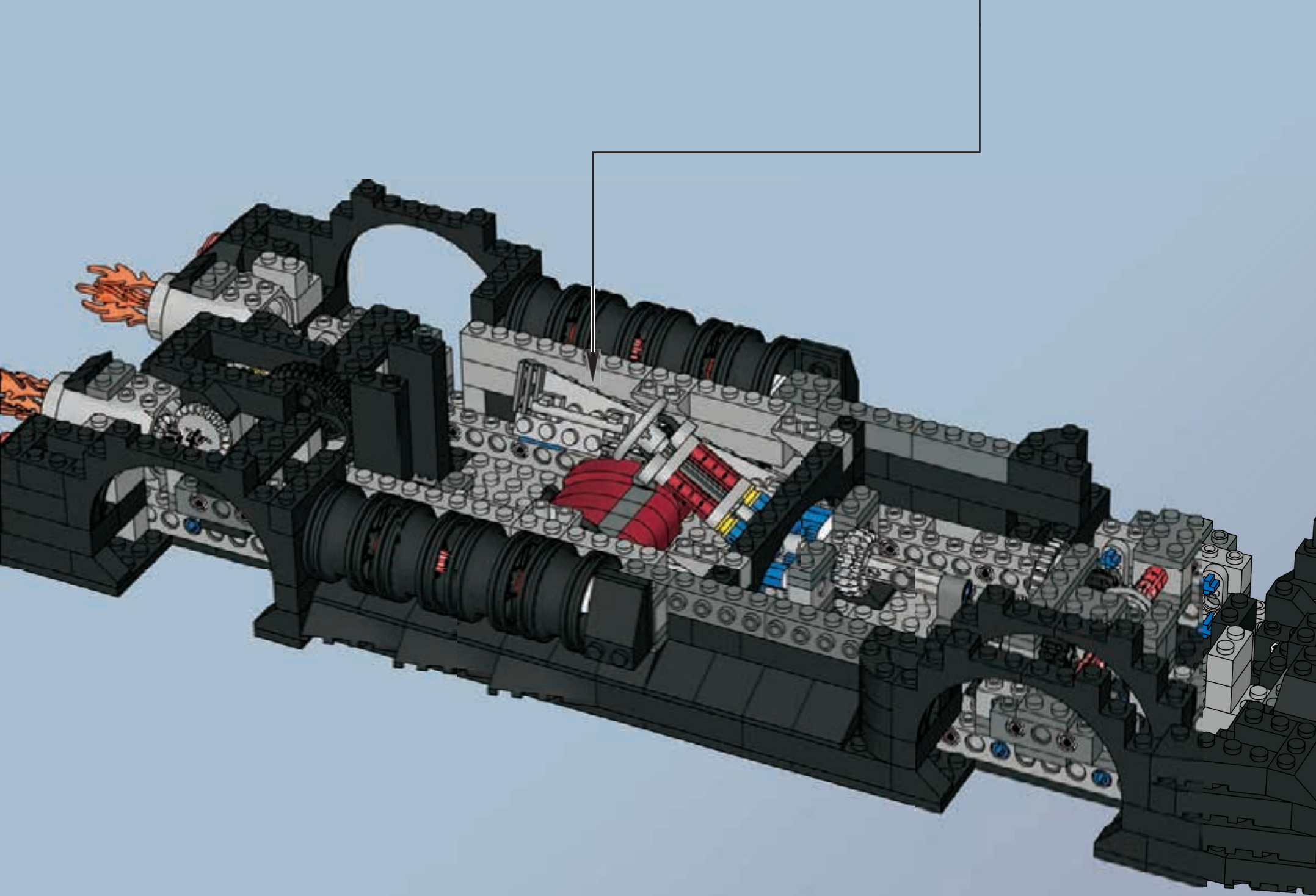



47

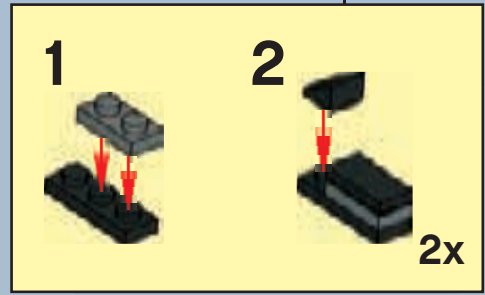
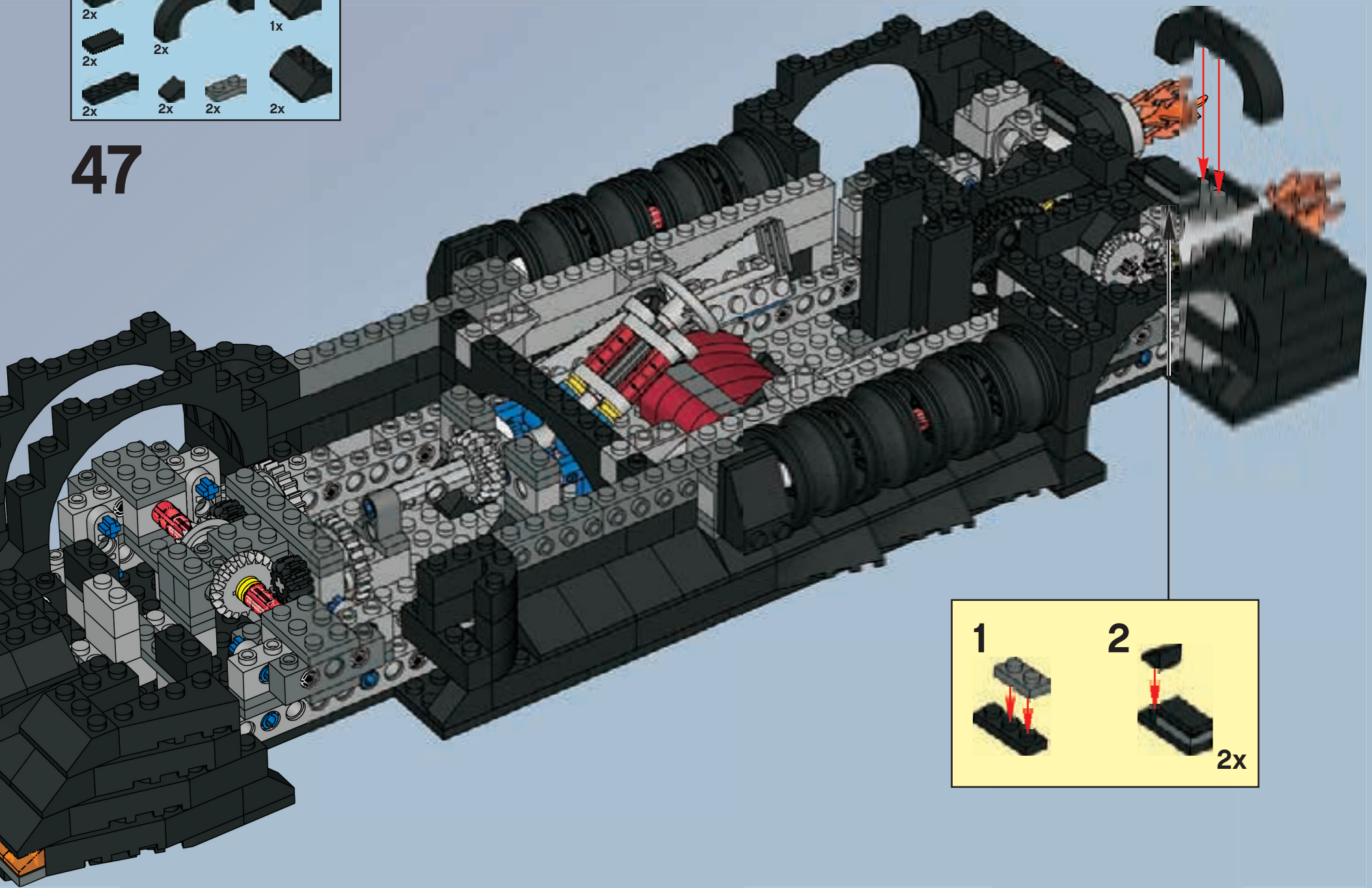

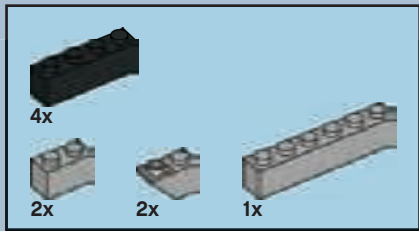

48

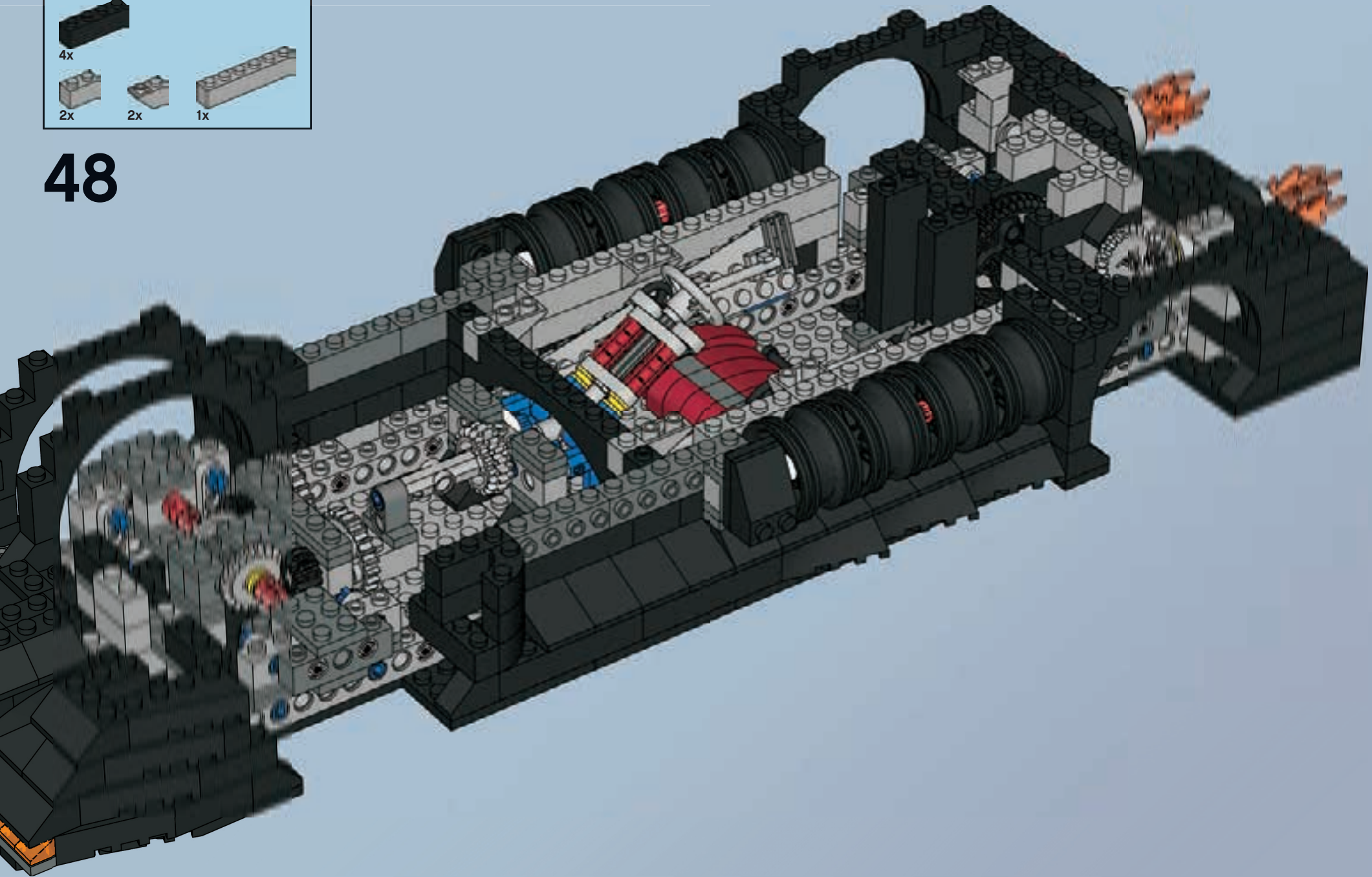

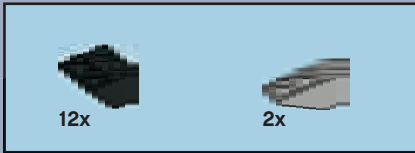

49

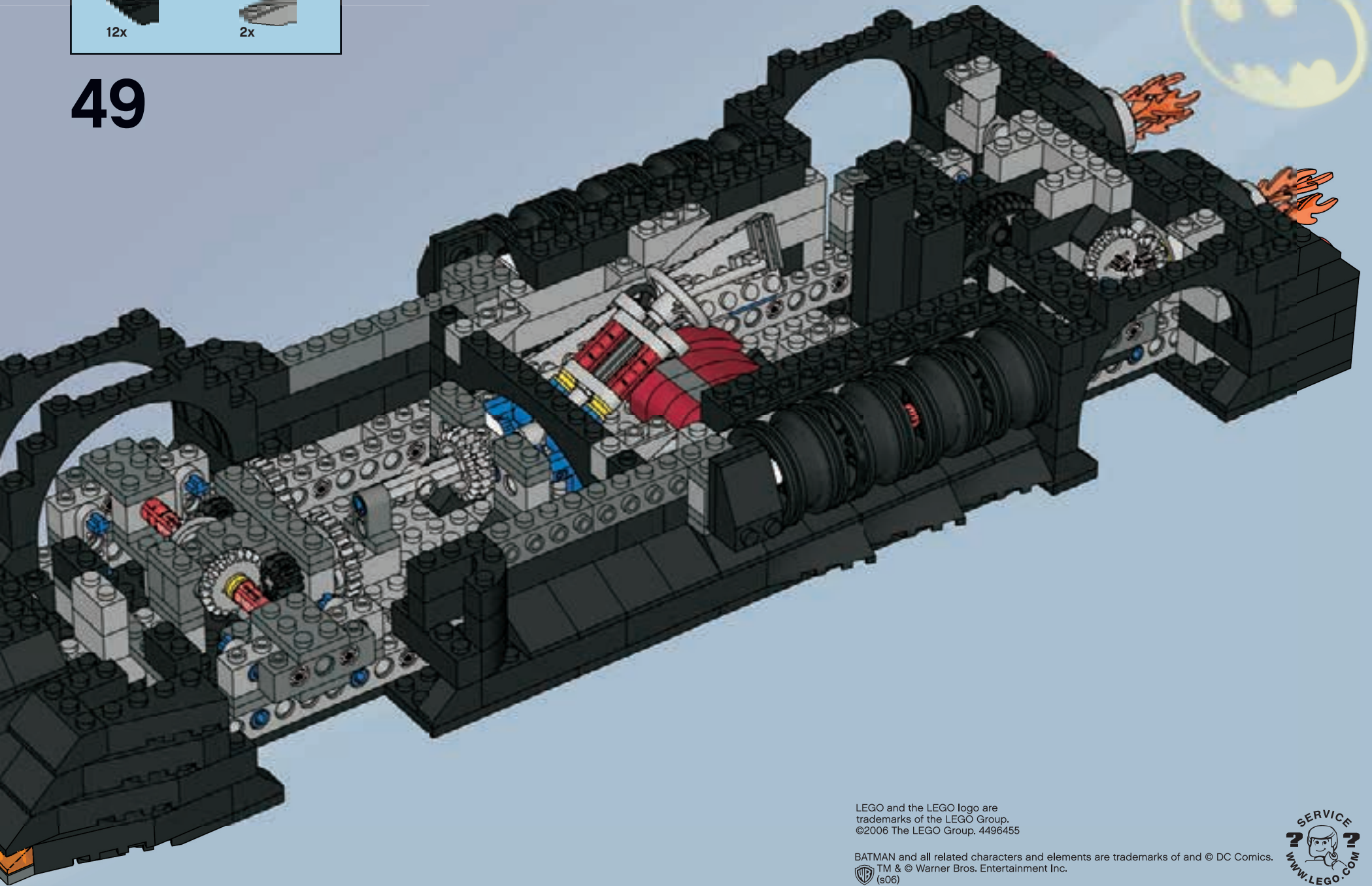

LEGO and the LEGO logo are trademarks of the LEGO Group.
©2006 The LEGO Group. 4496455

BATMAN and all related characters and elements are trademarks of and © DC Comics.
TM & © Warner Bros. Entertainment Inc.
(s06)





BATMAN



7784
Book 2





50

1



2

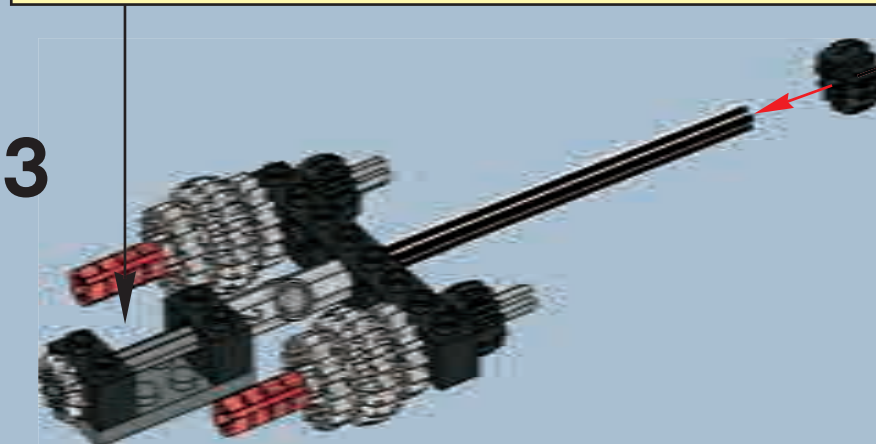
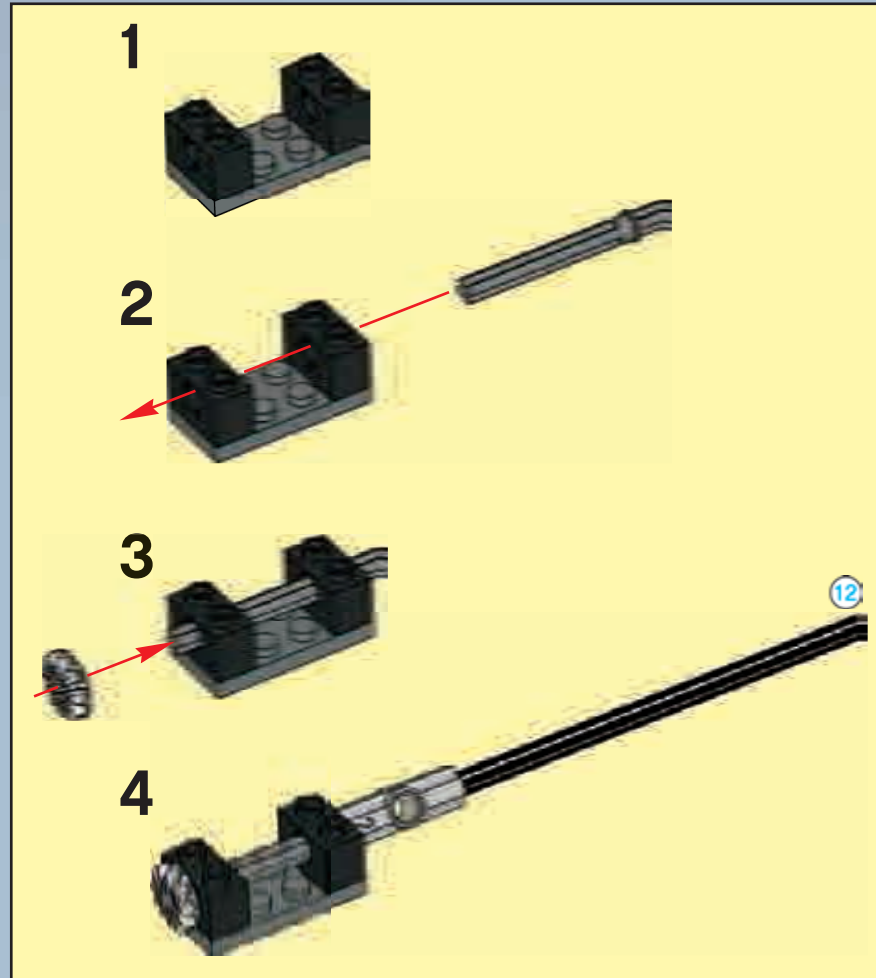
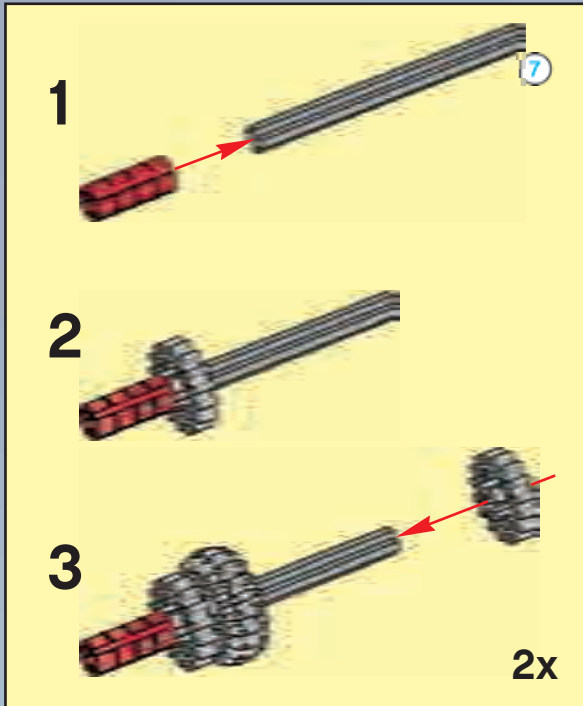
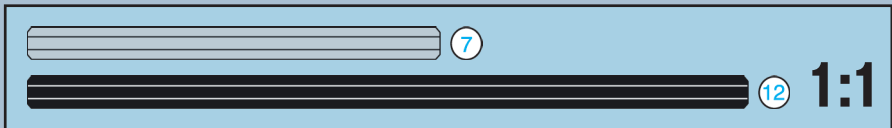
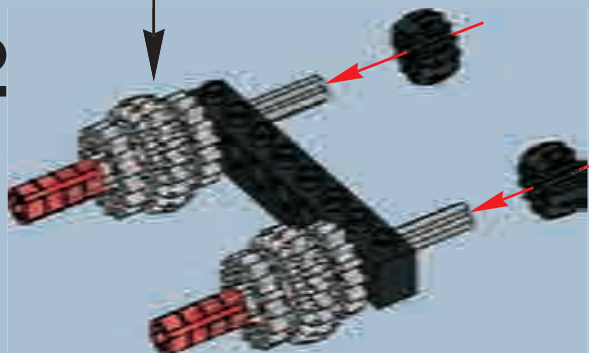

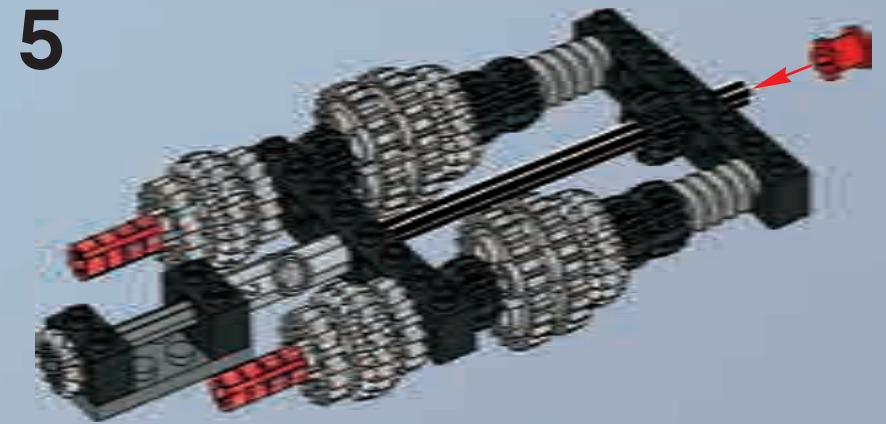
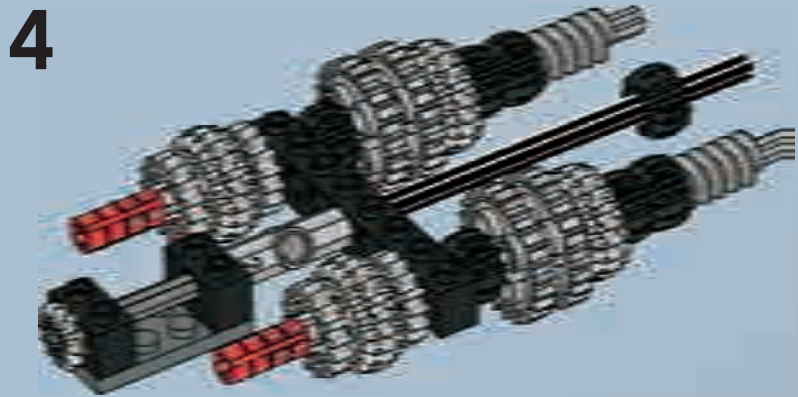
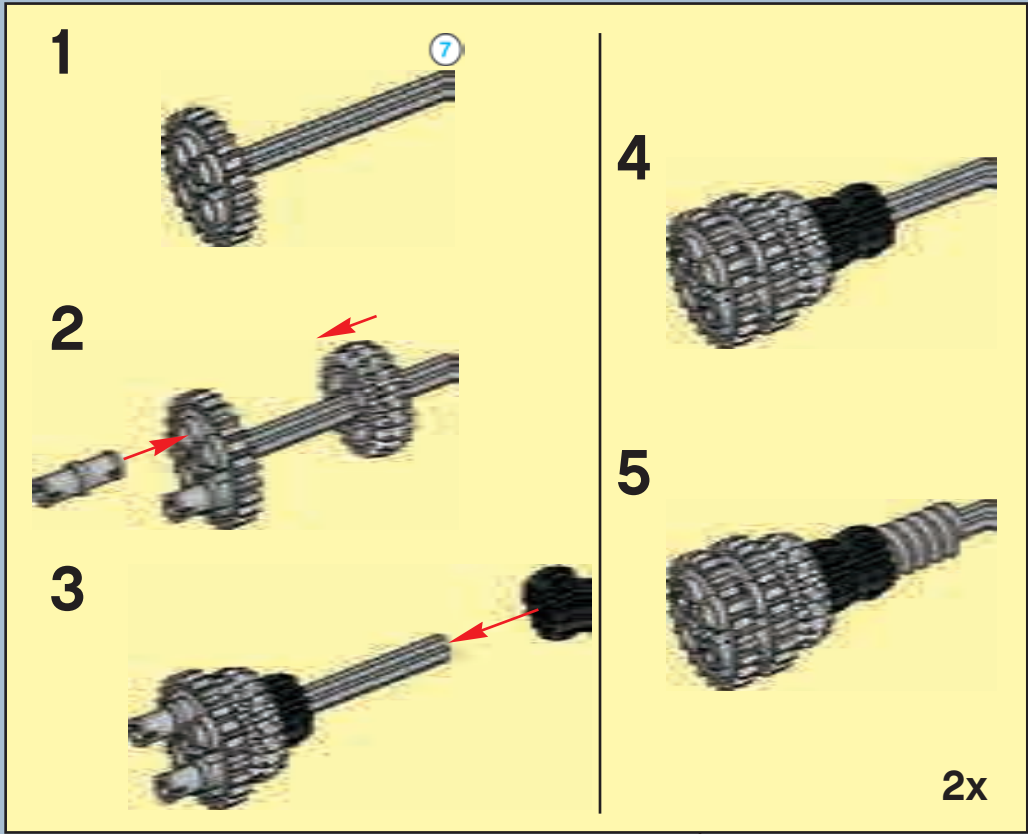

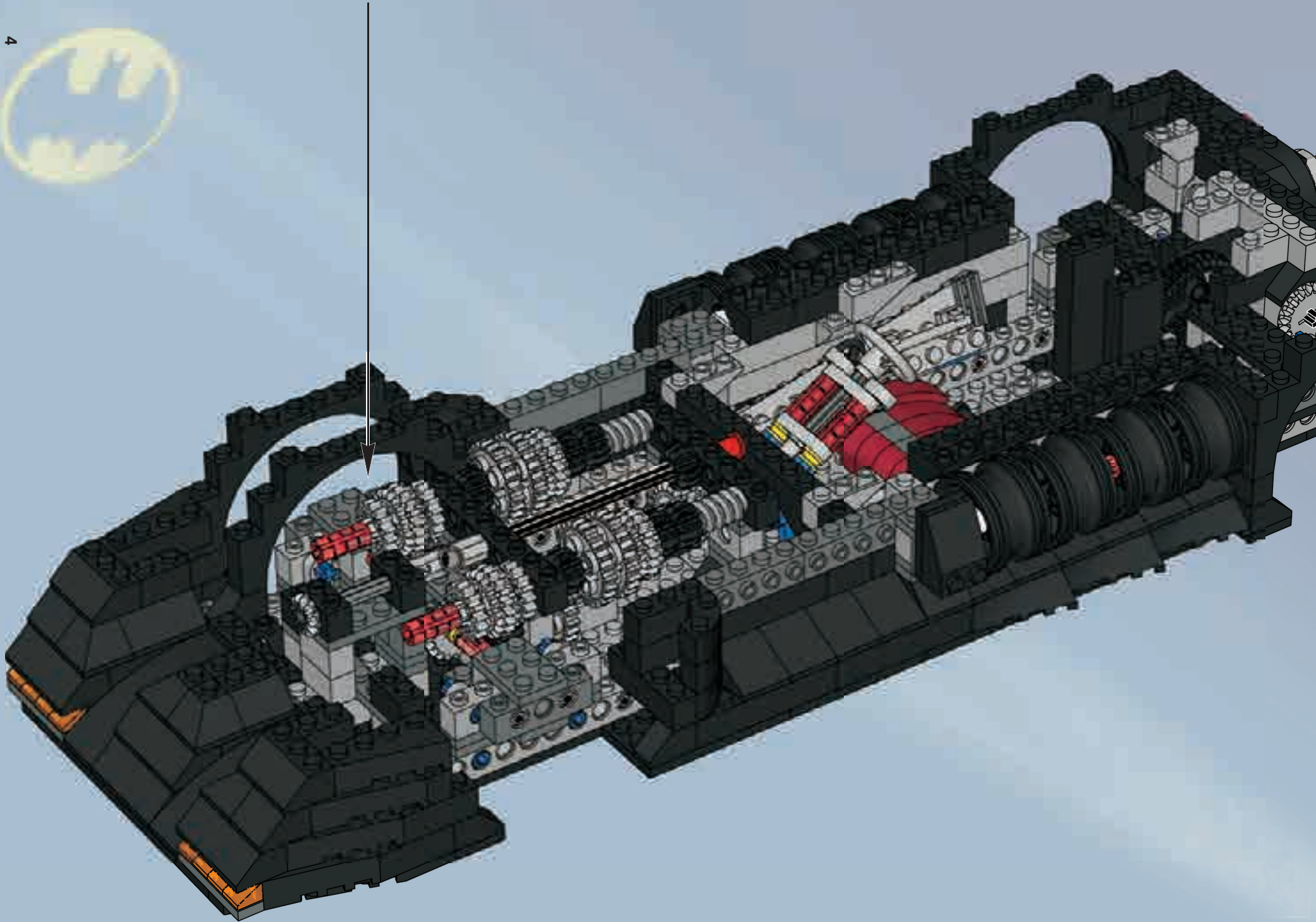

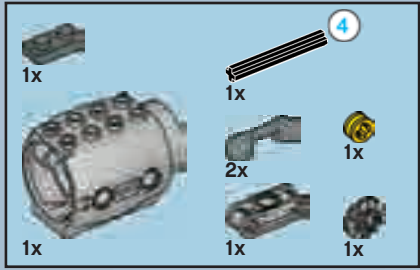

51

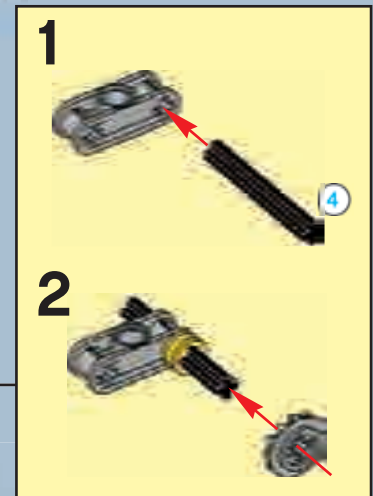
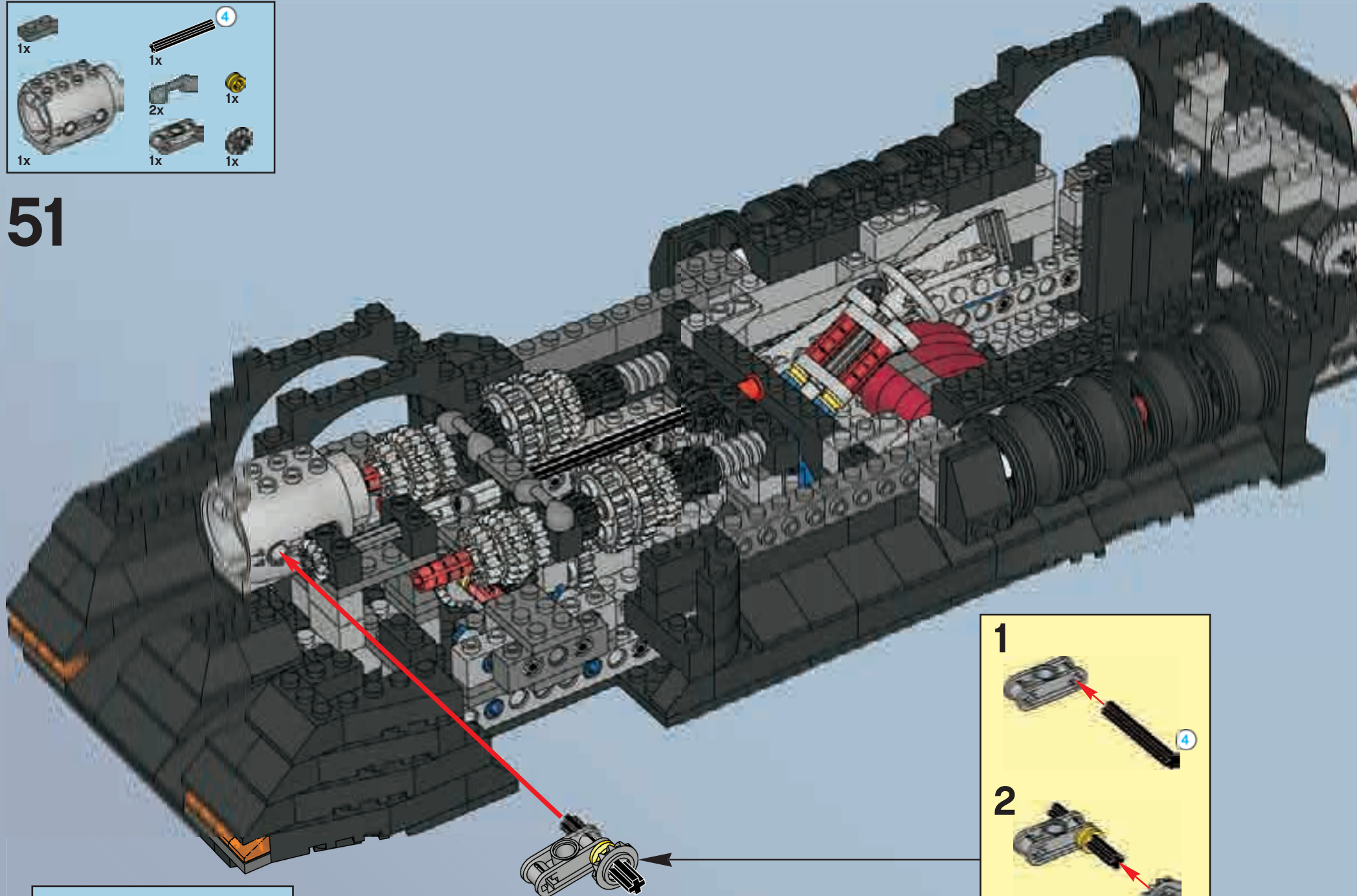



52

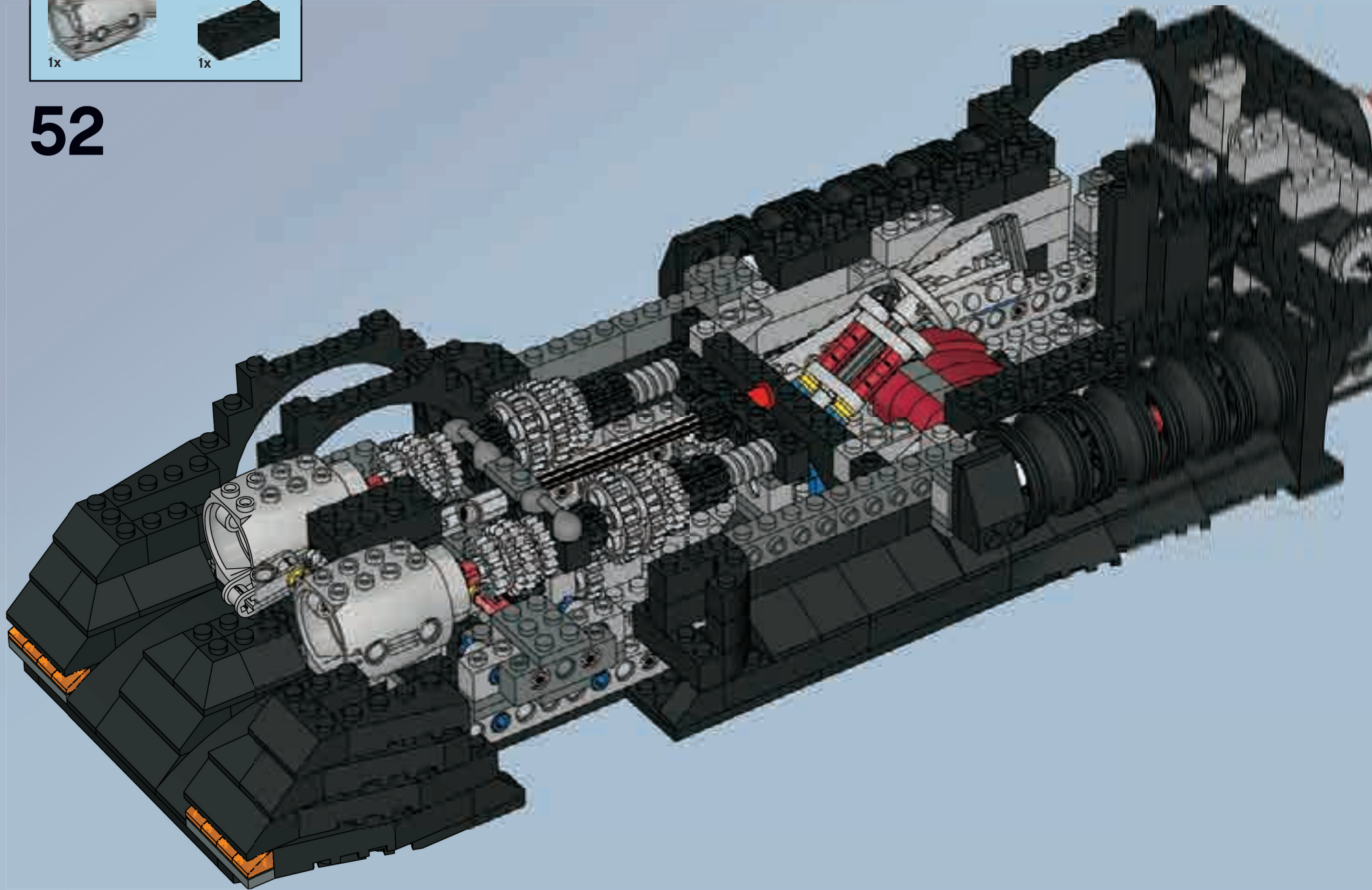



53

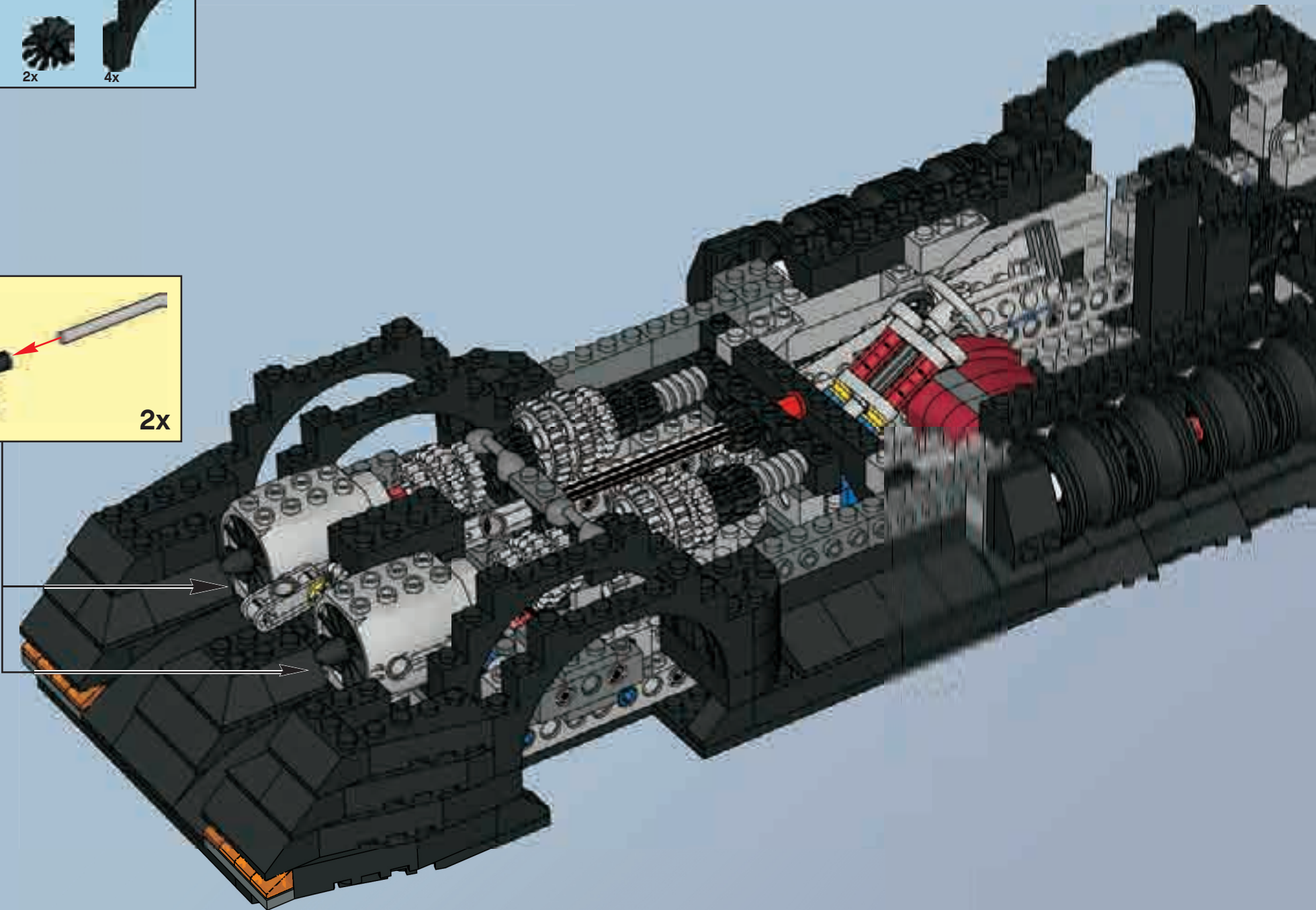

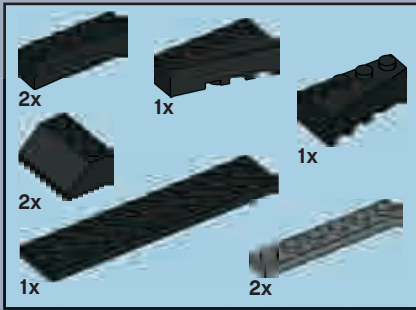

54

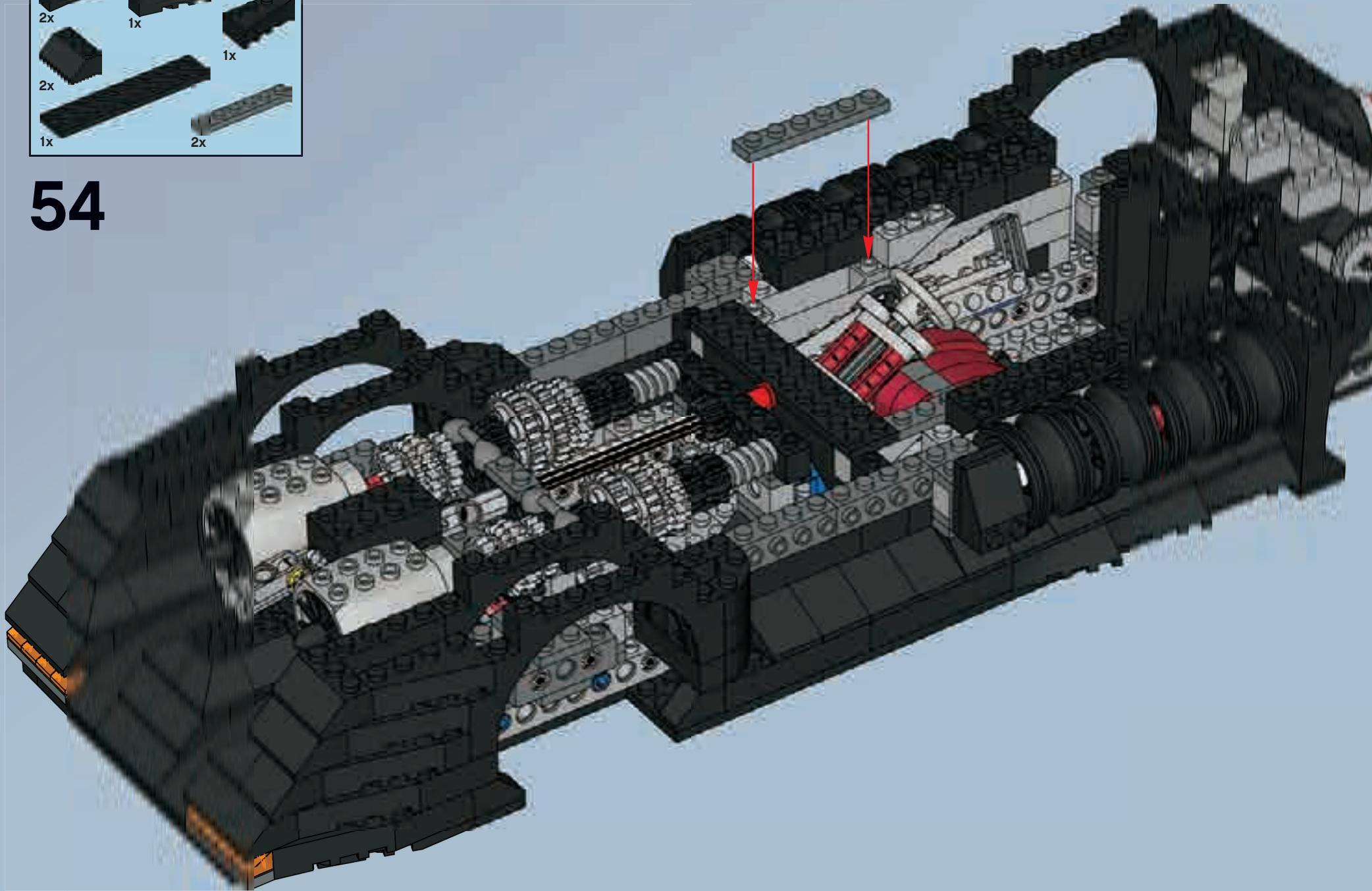



55

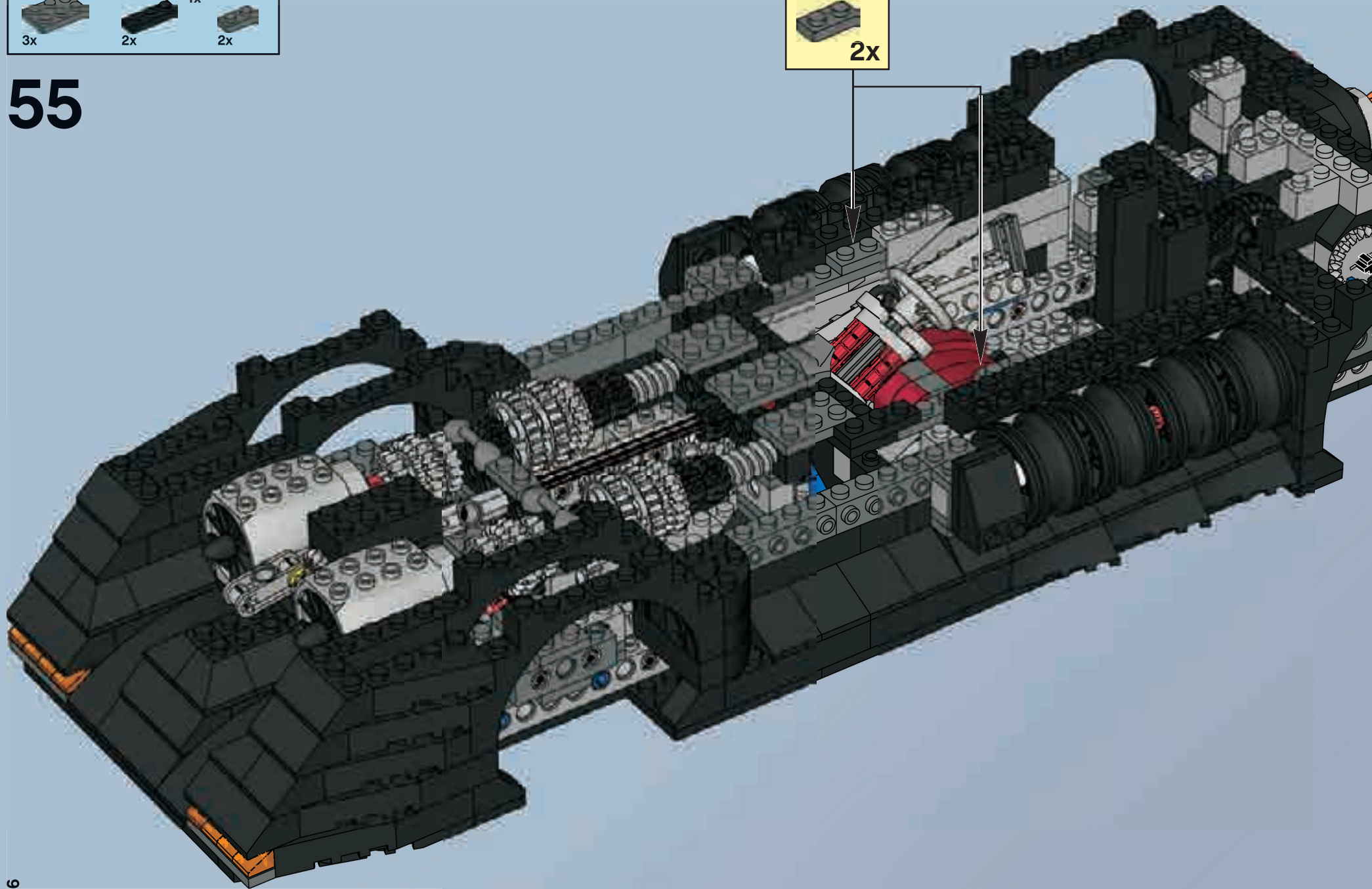

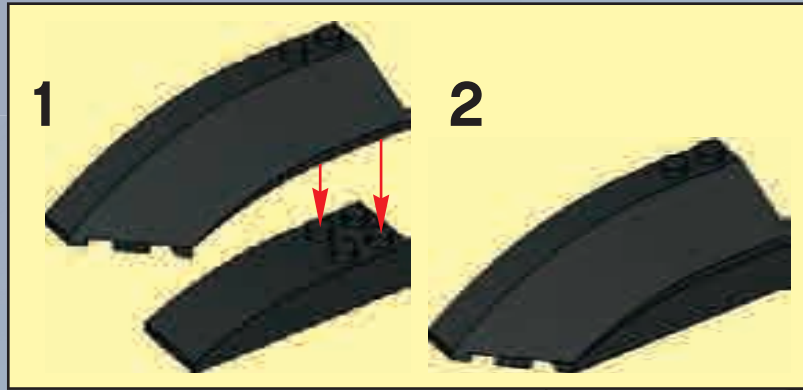
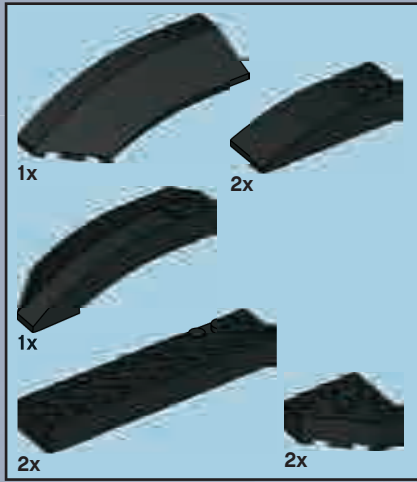

56

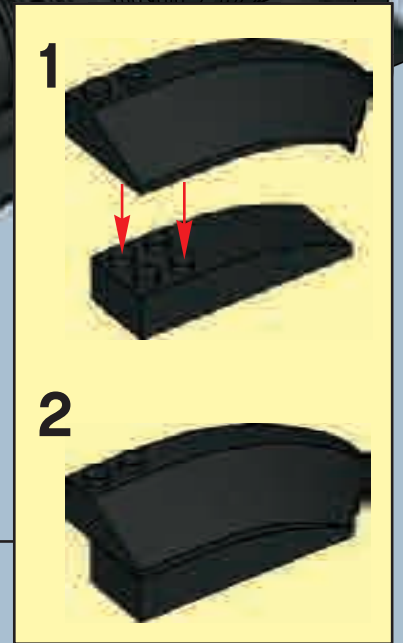
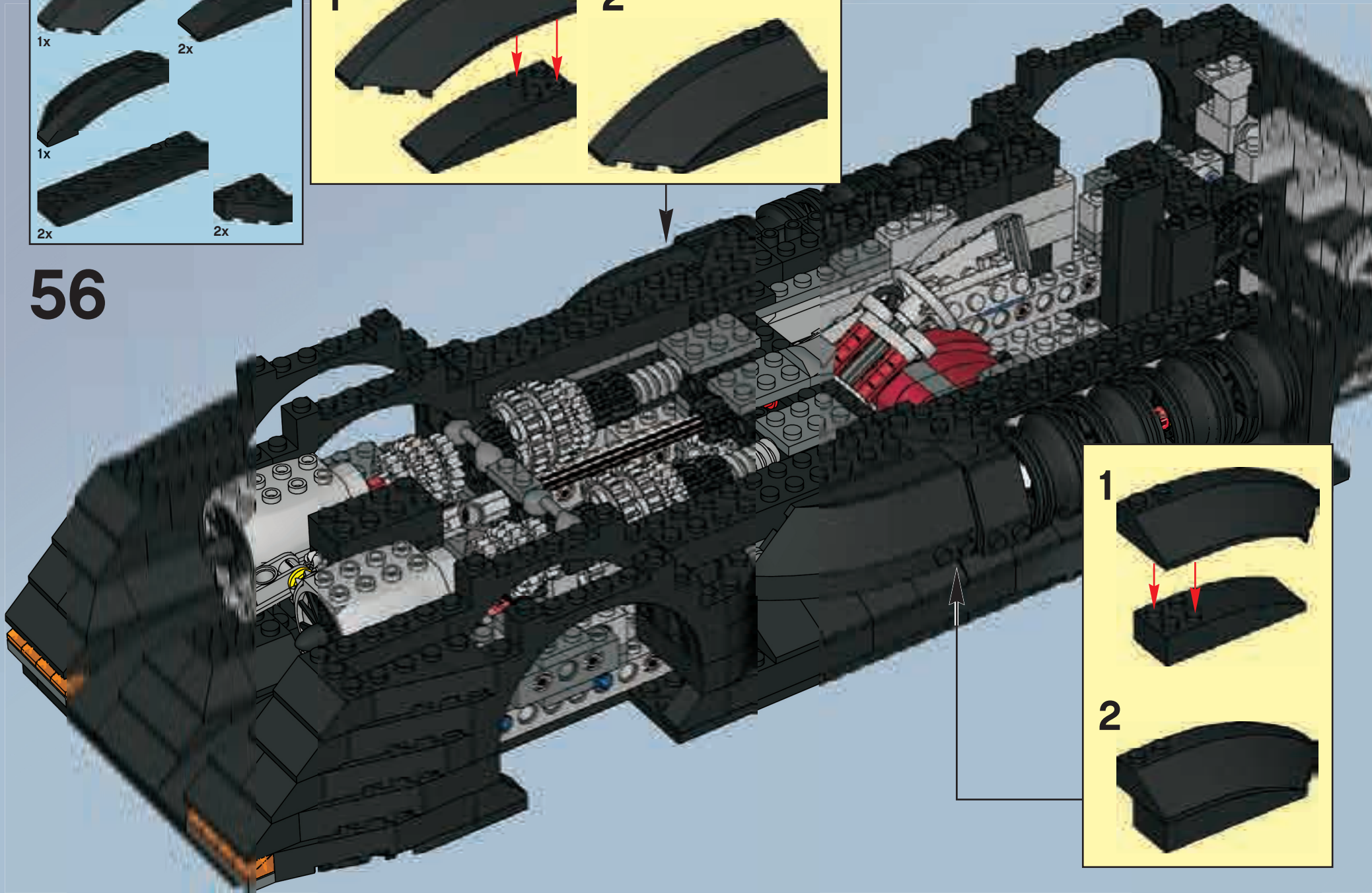

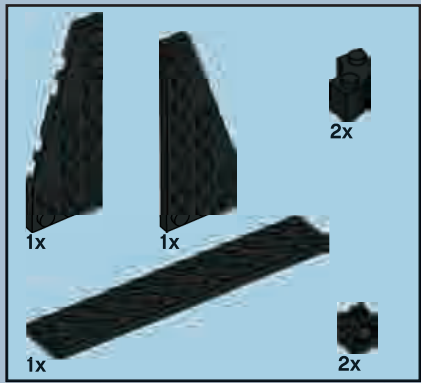

57

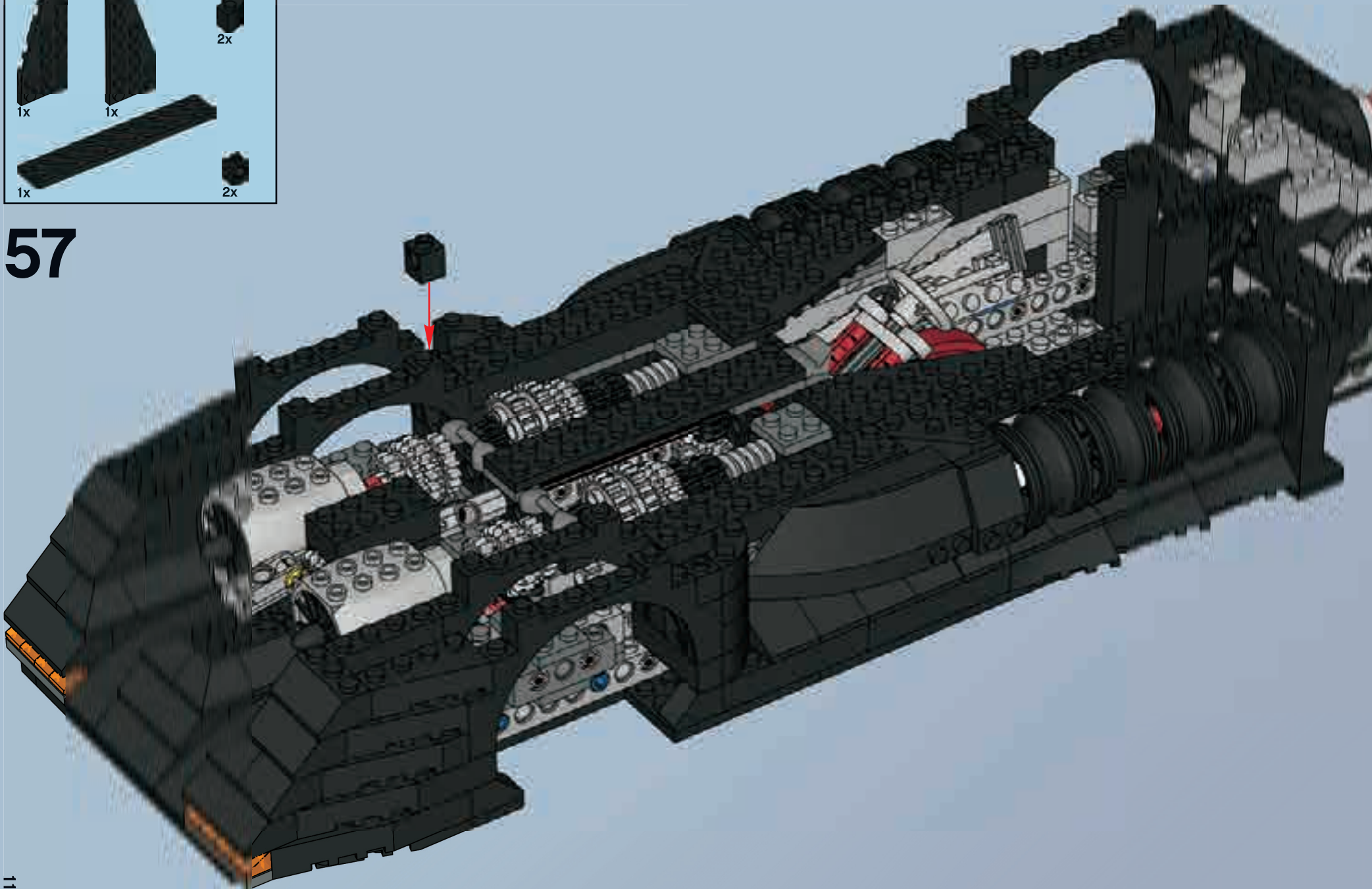

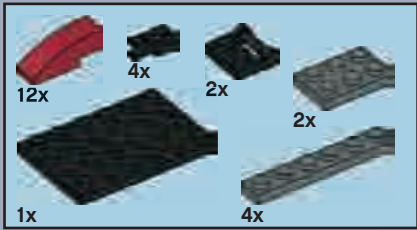

58

1



2

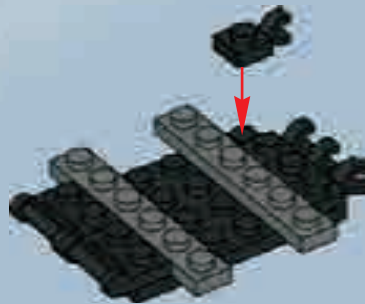

3



4



5



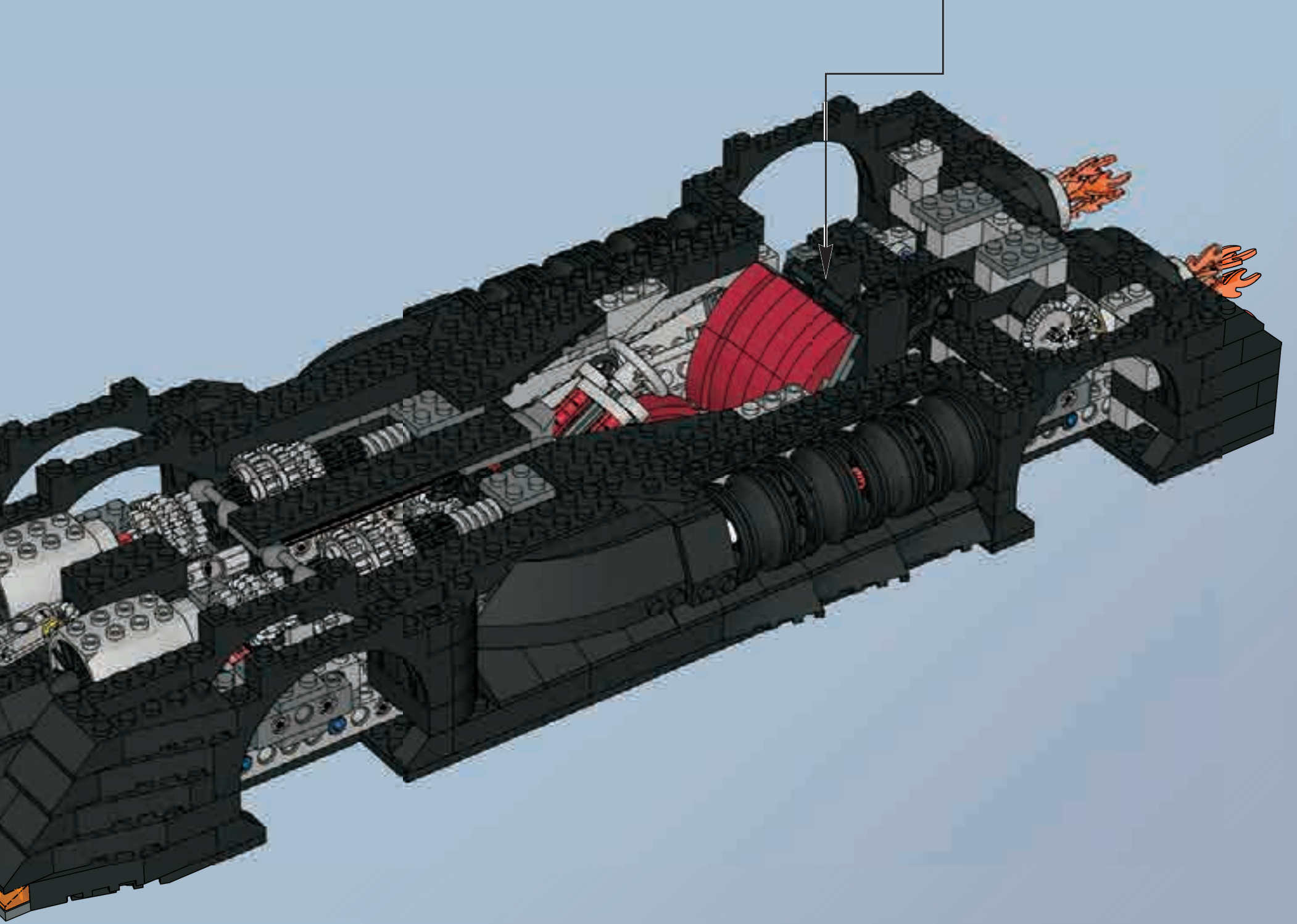

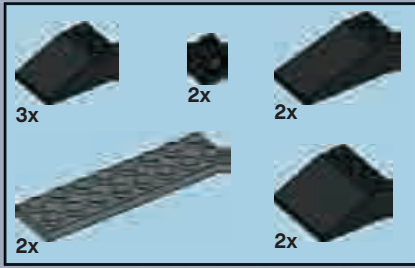

59

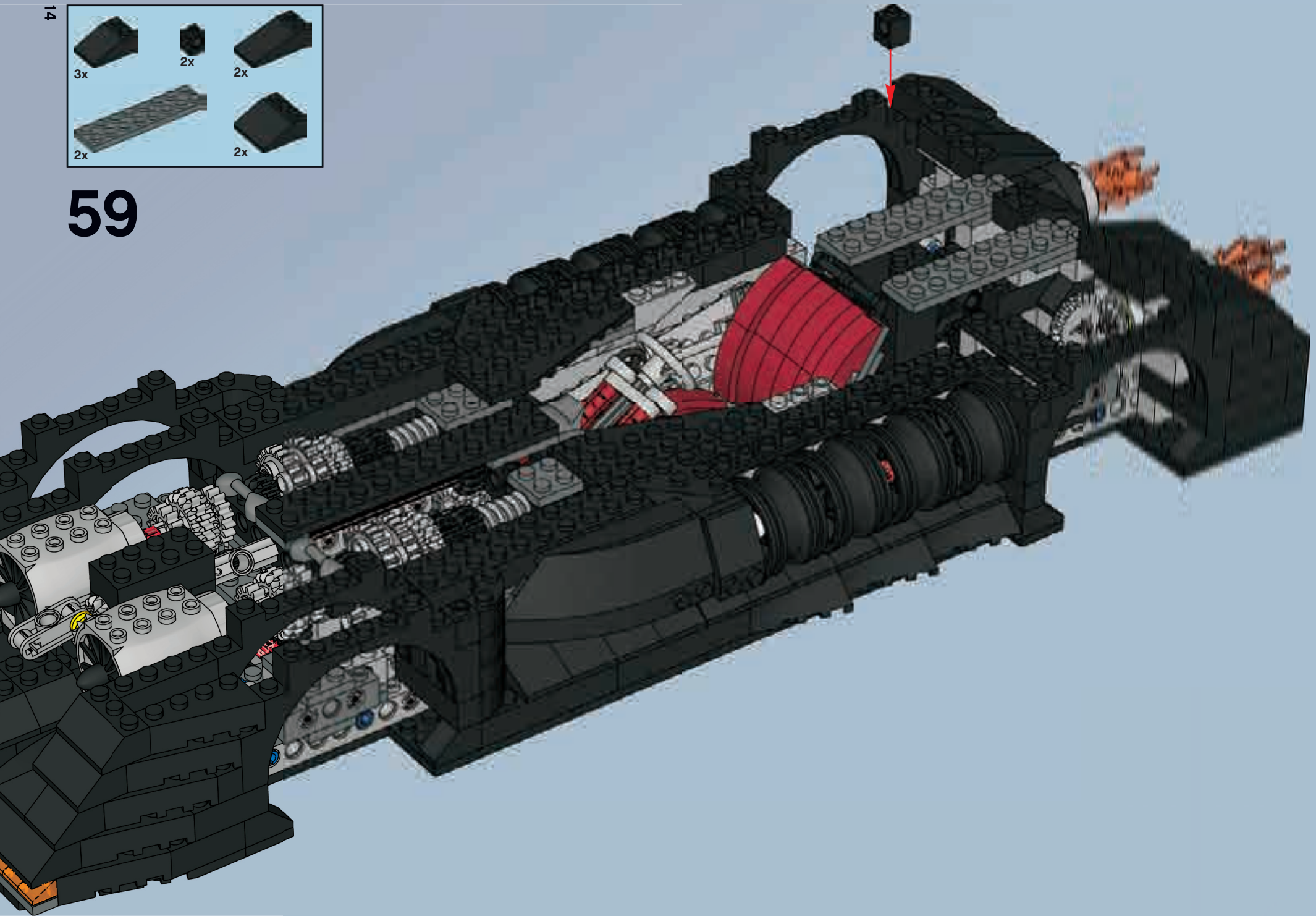

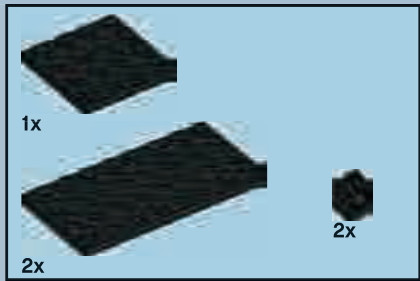

60

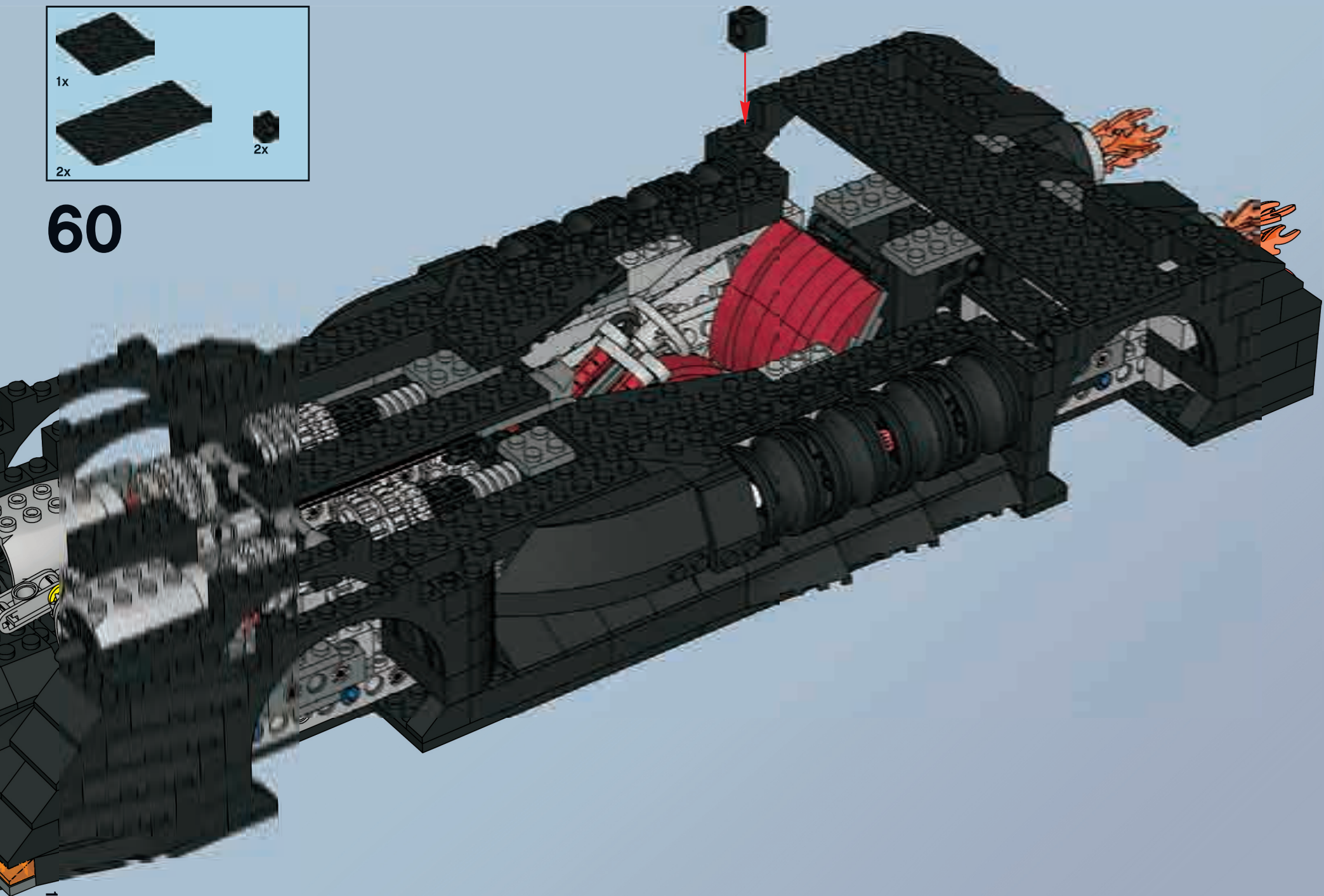

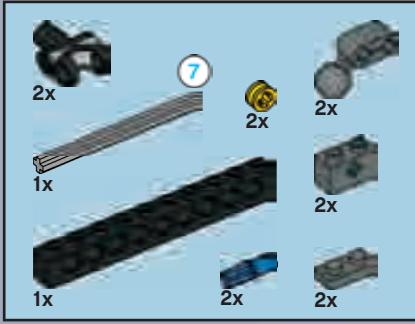

61

1



2



3

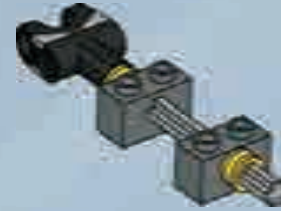

4

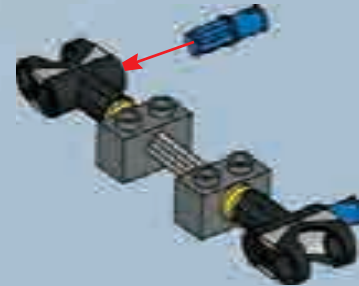

5

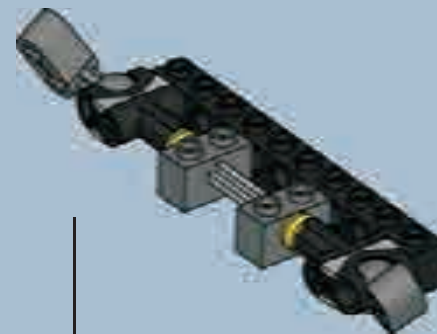

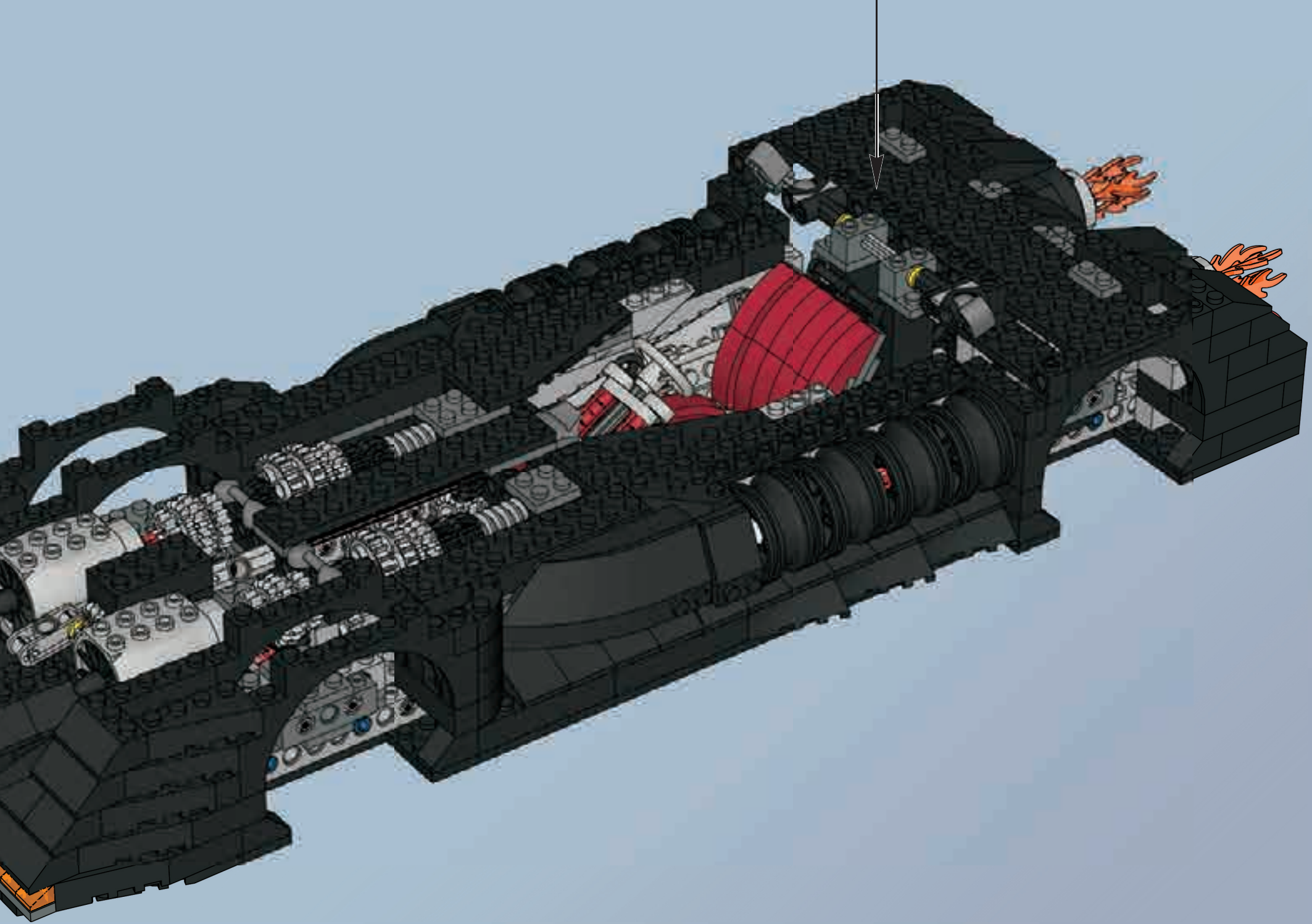

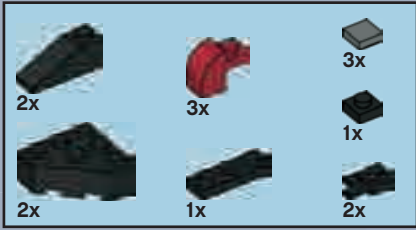

62

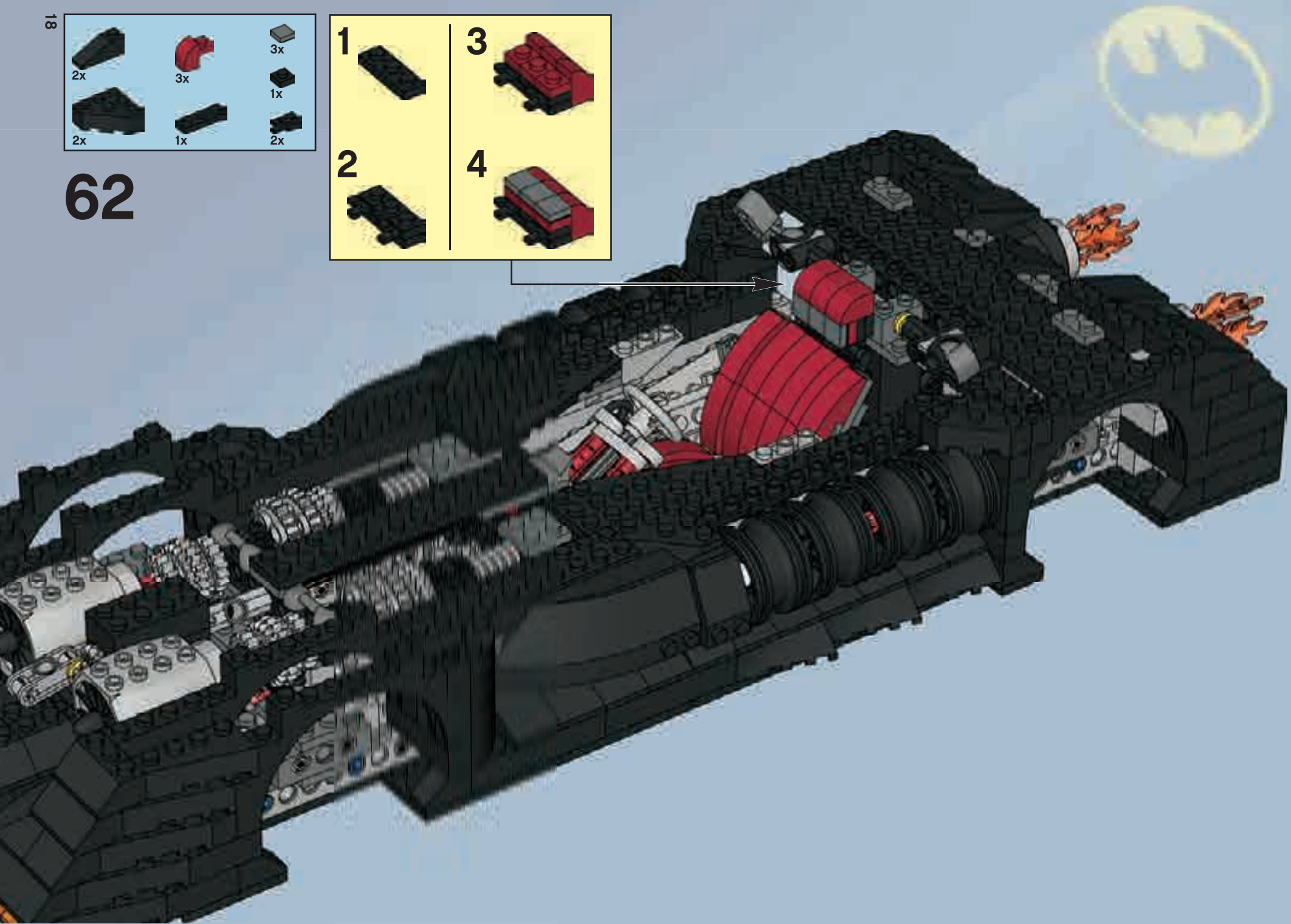
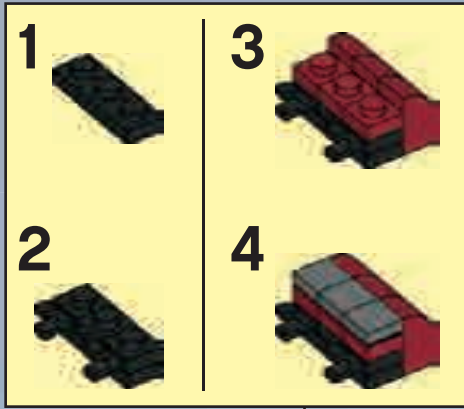

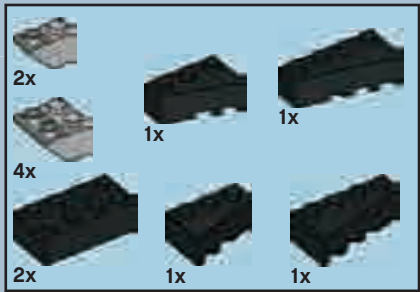

63

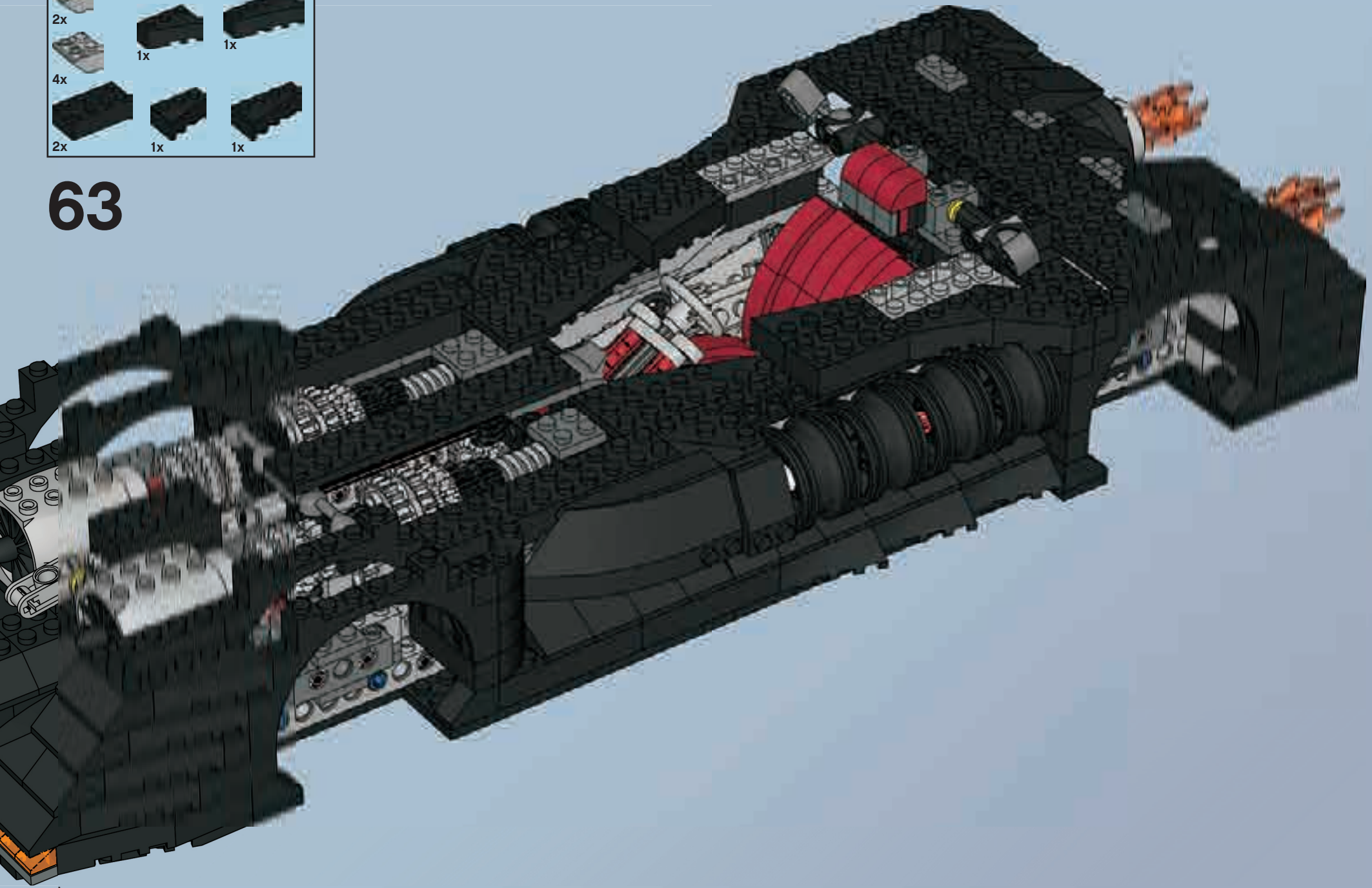



64

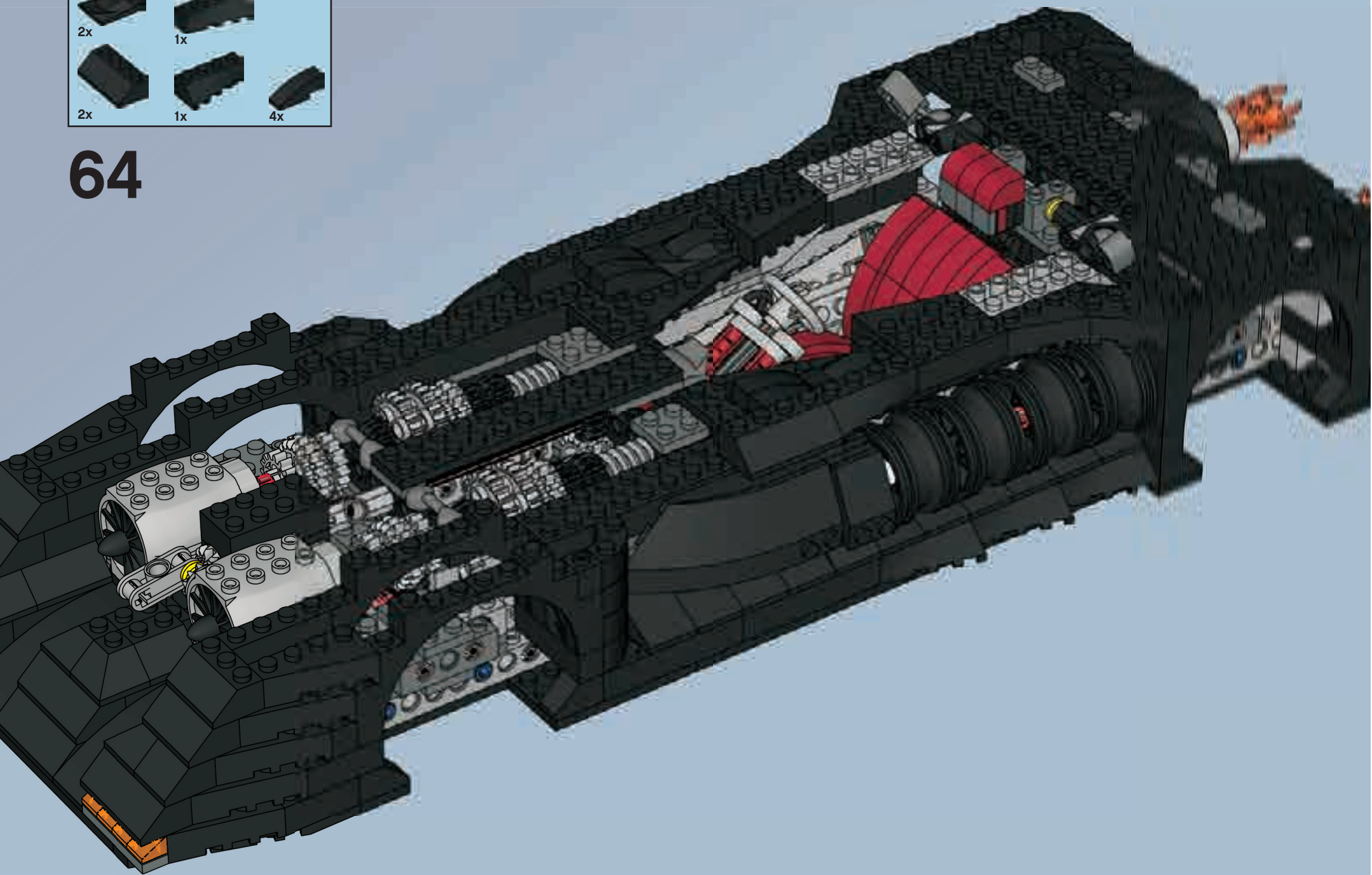



65

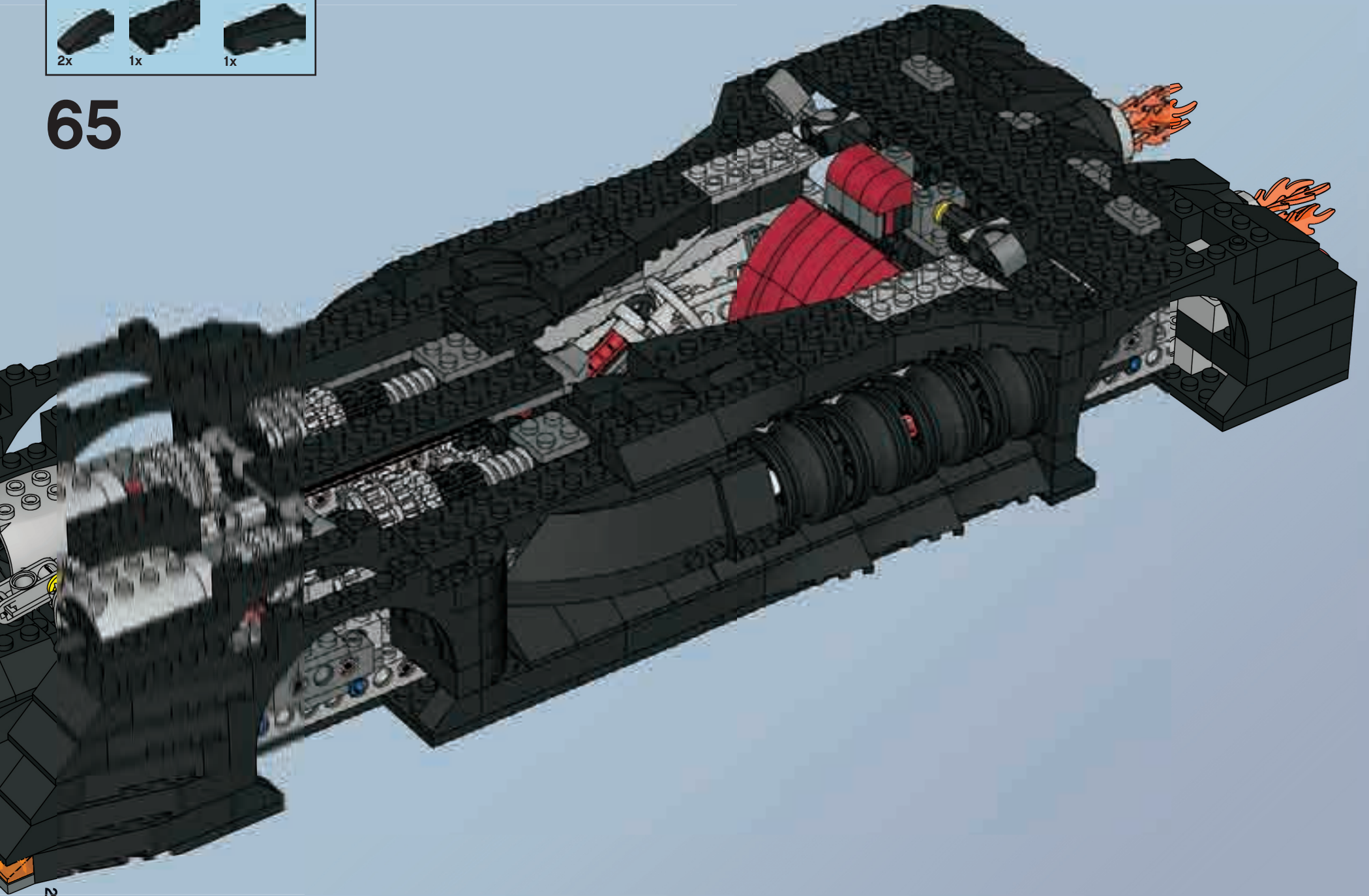



66

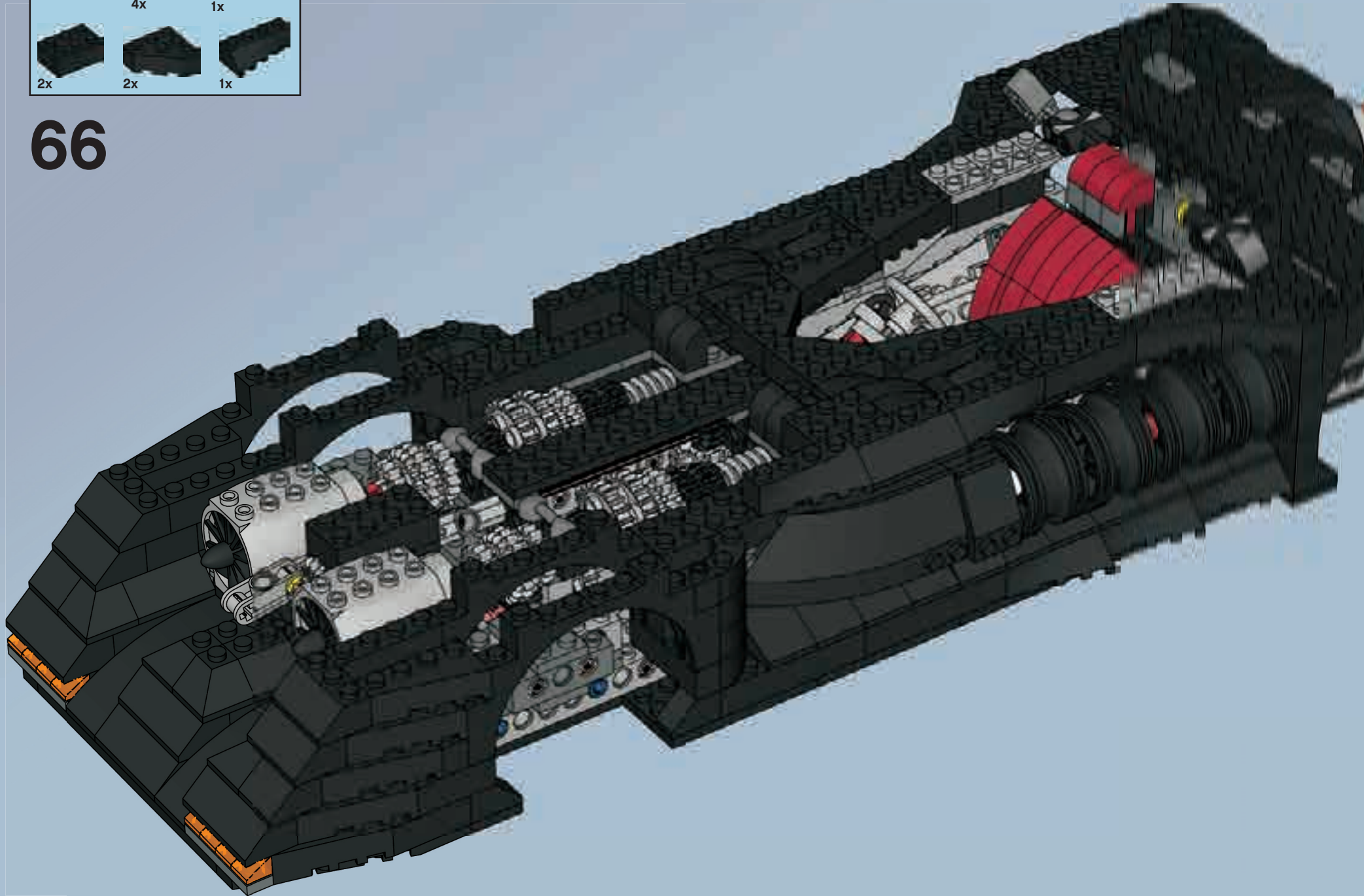

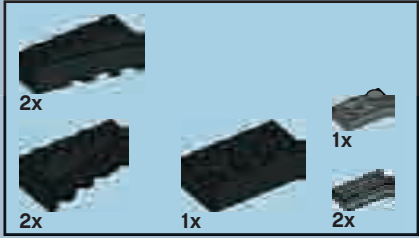

67

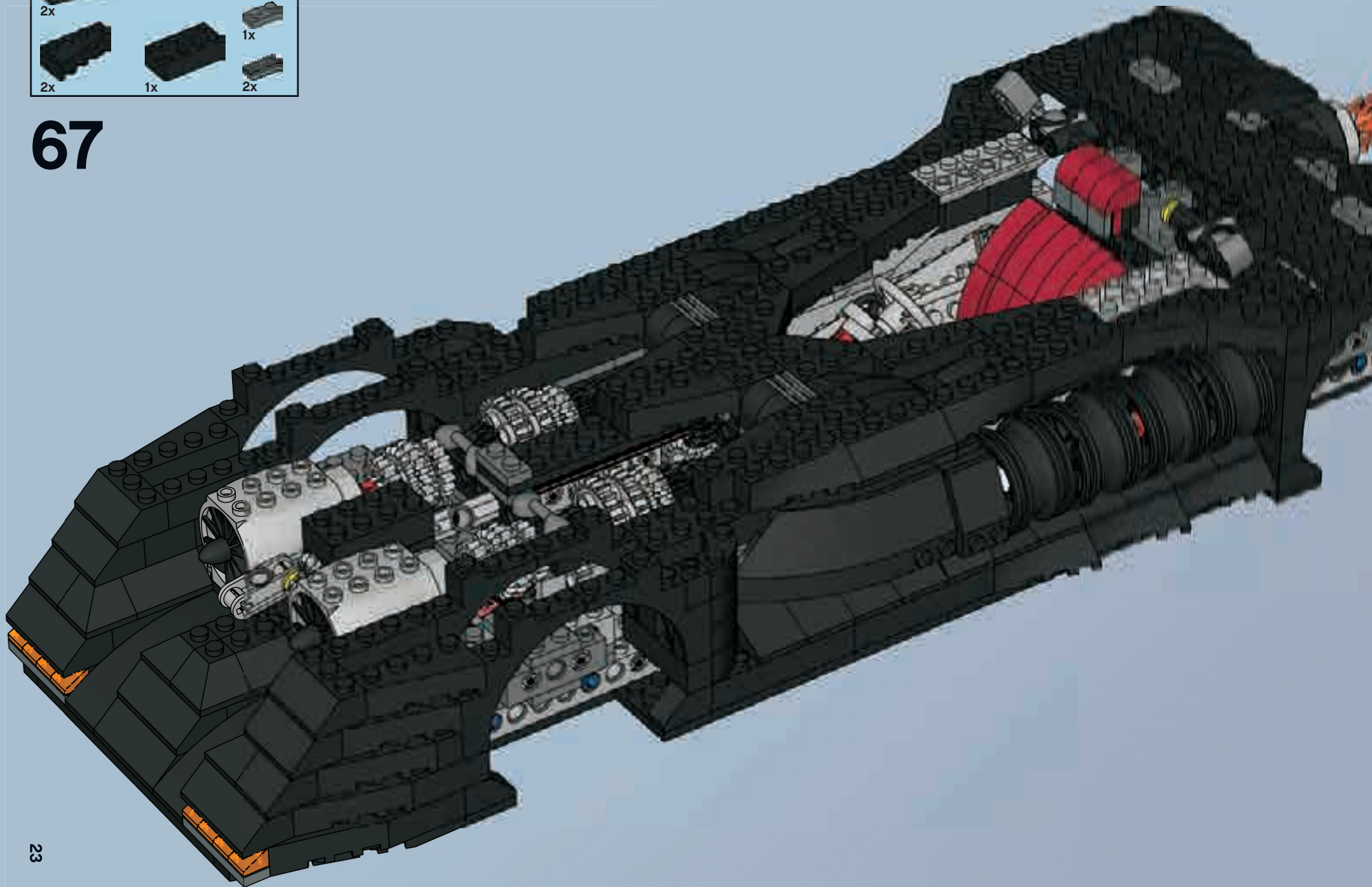



68

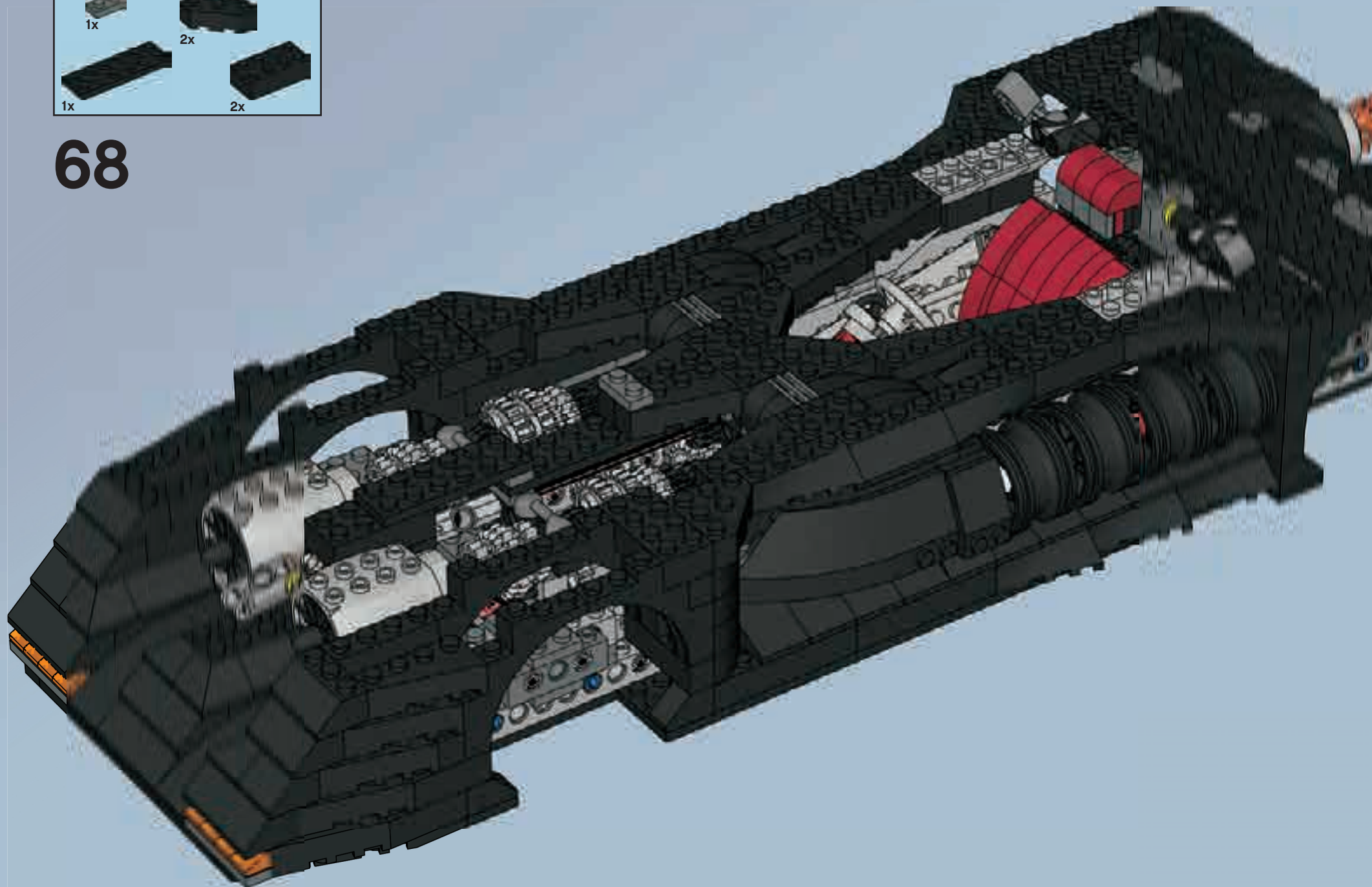

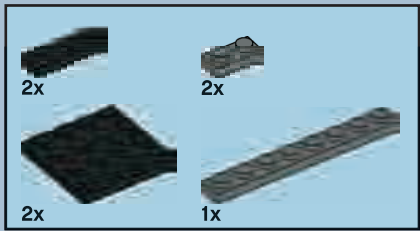

69





70

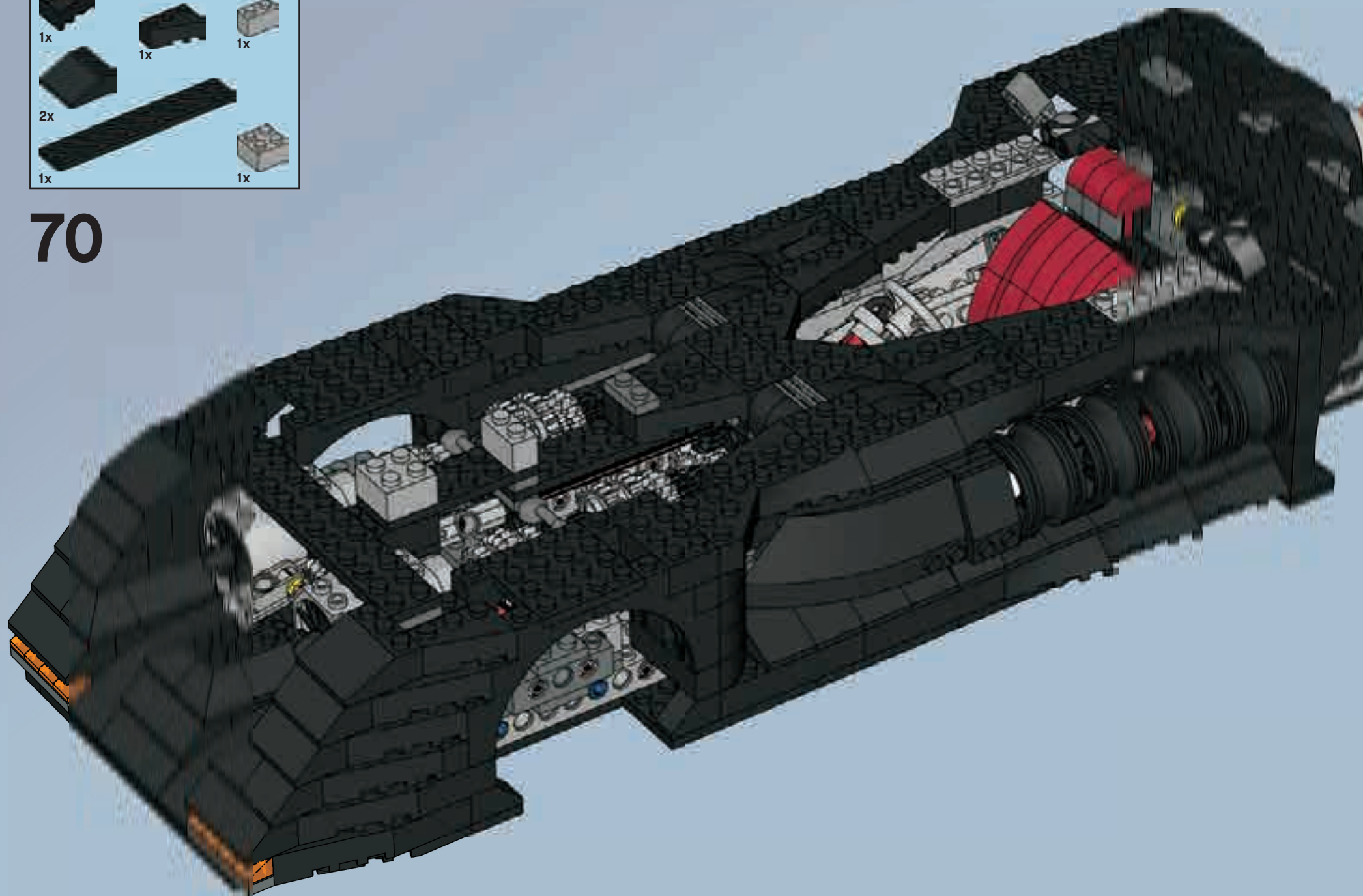



71

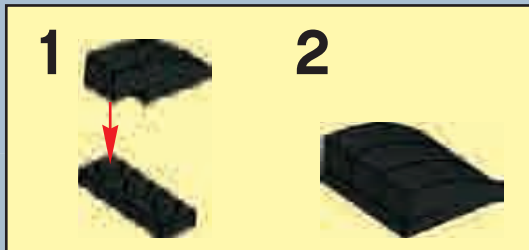

2

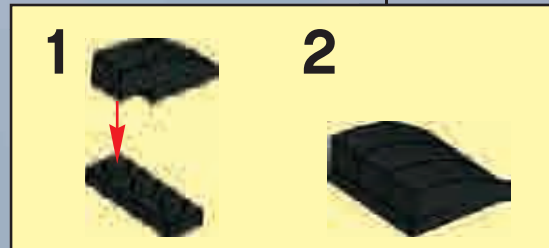
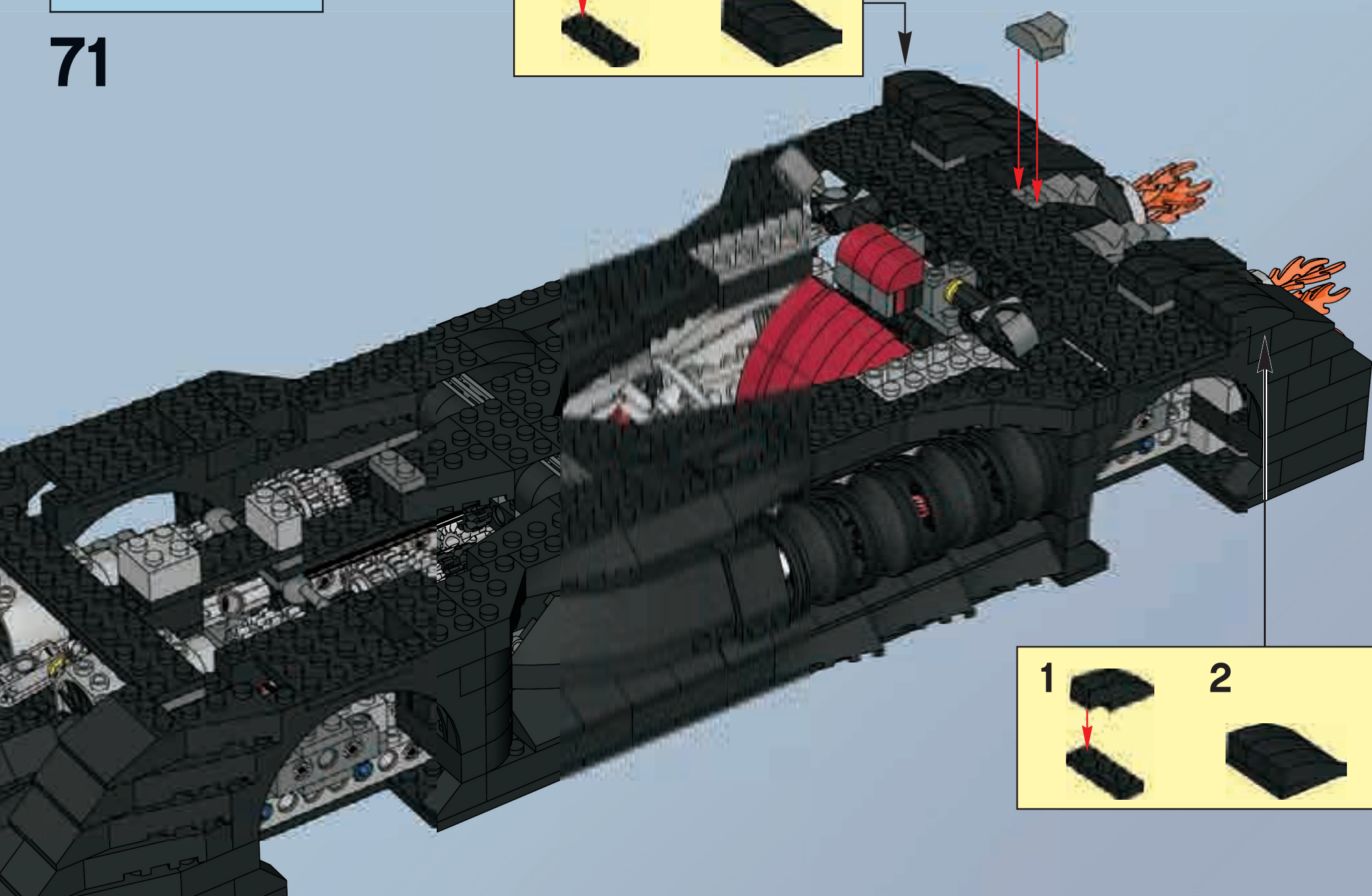



72

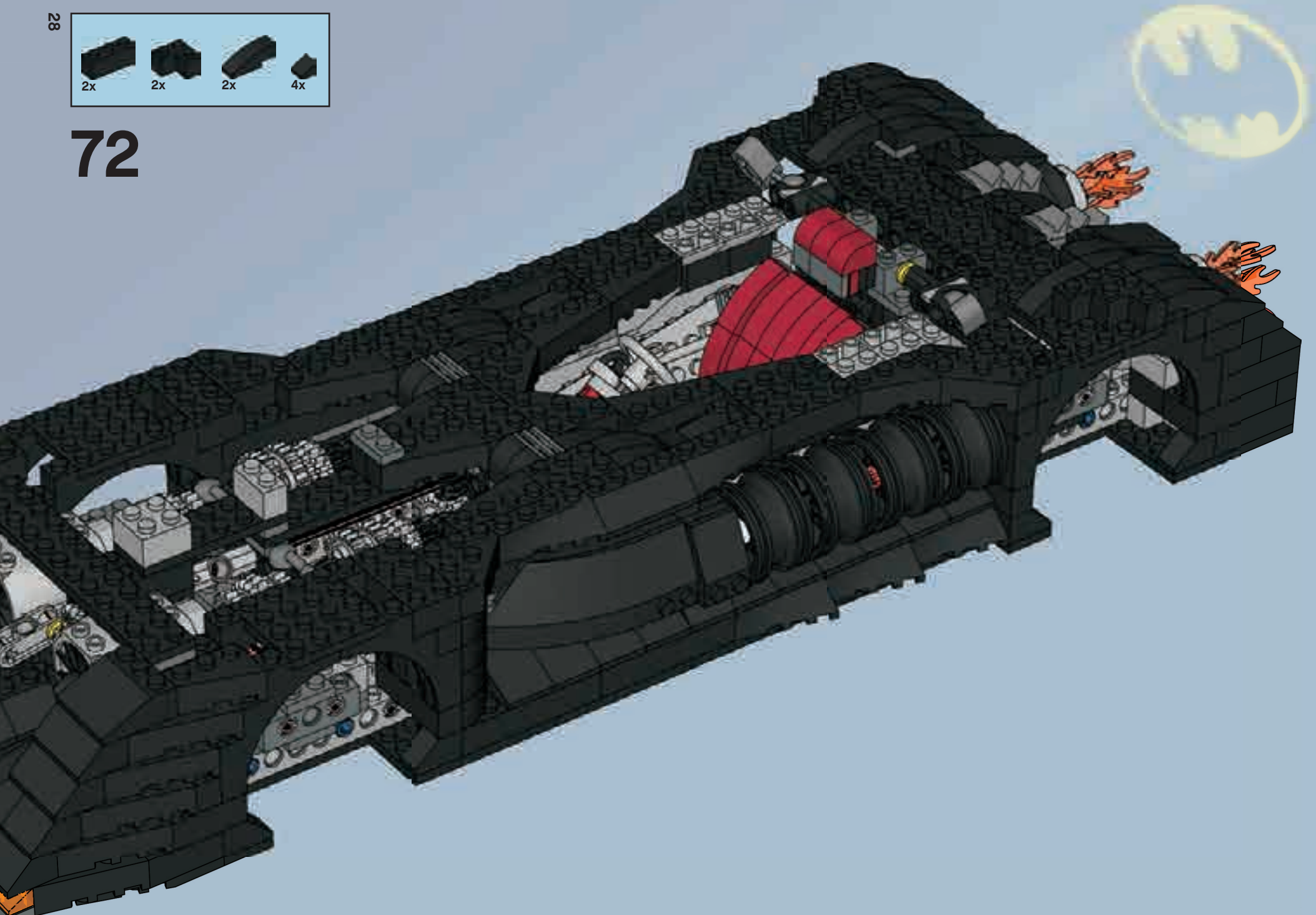



73

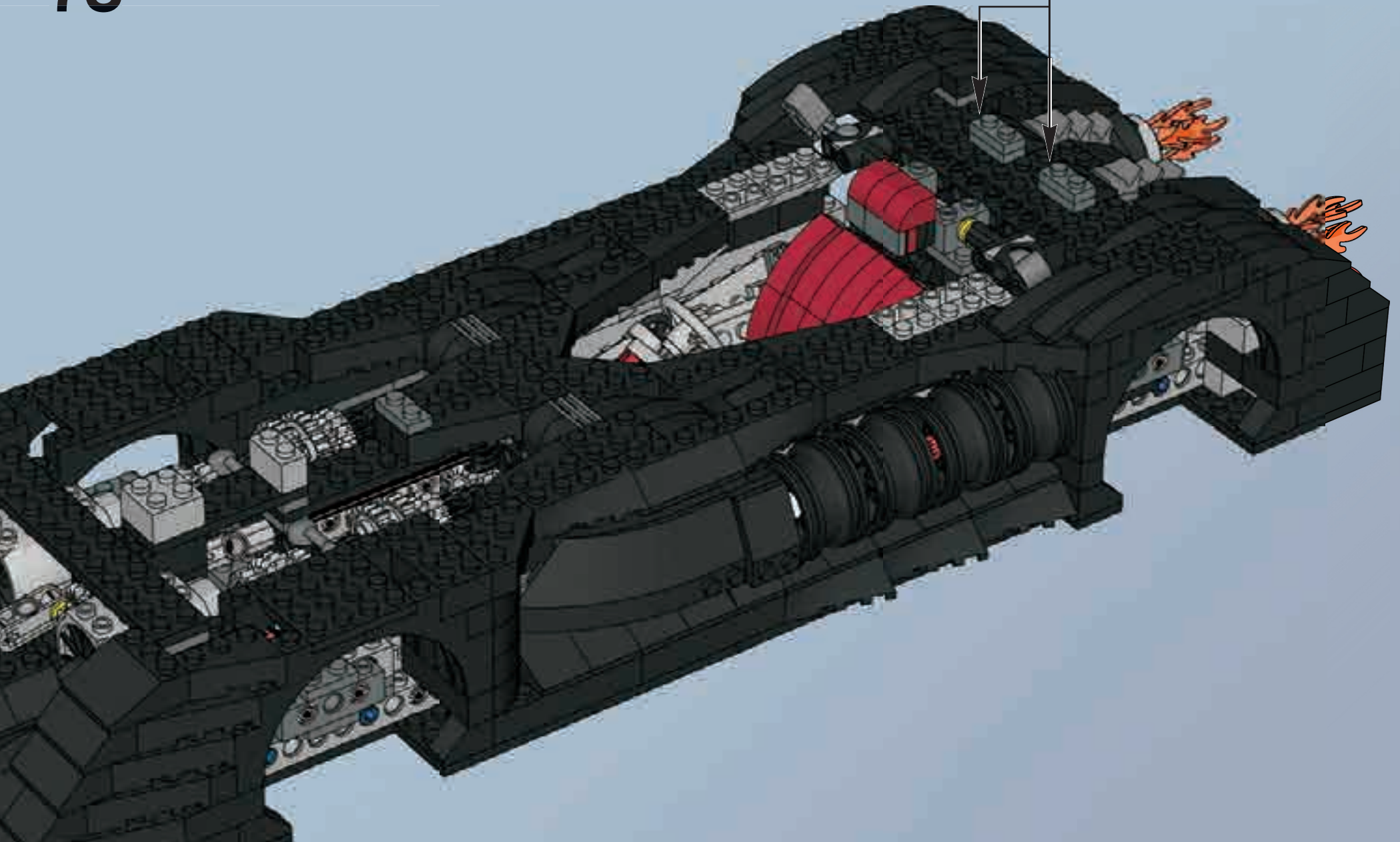
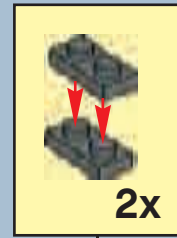

30

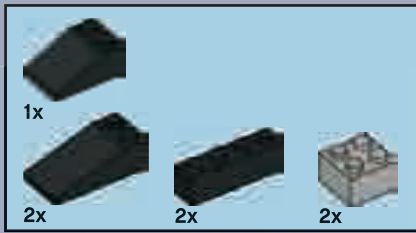

74

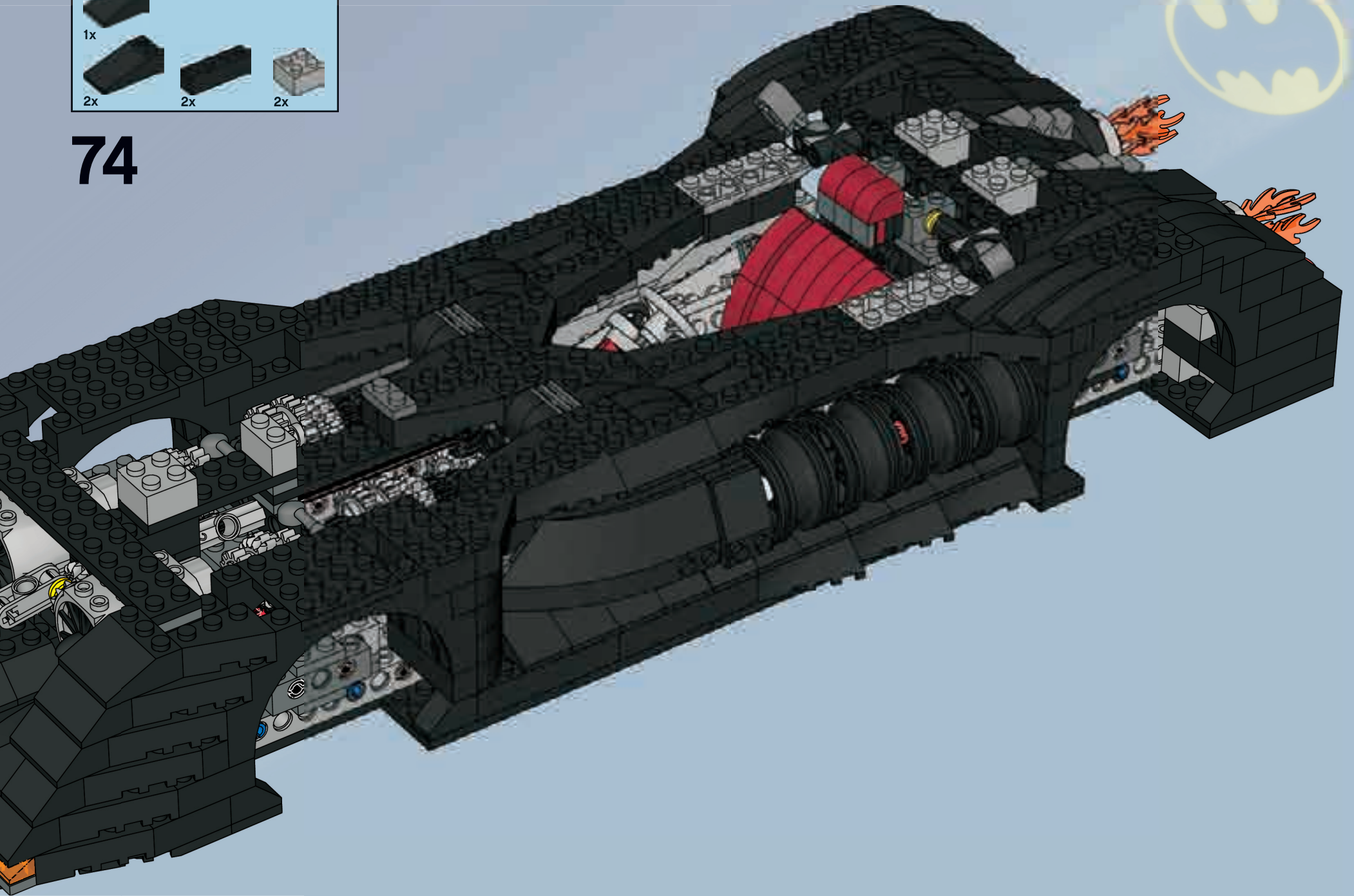

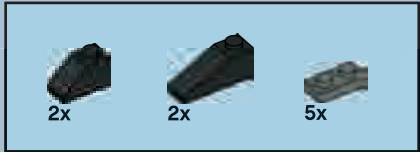

75

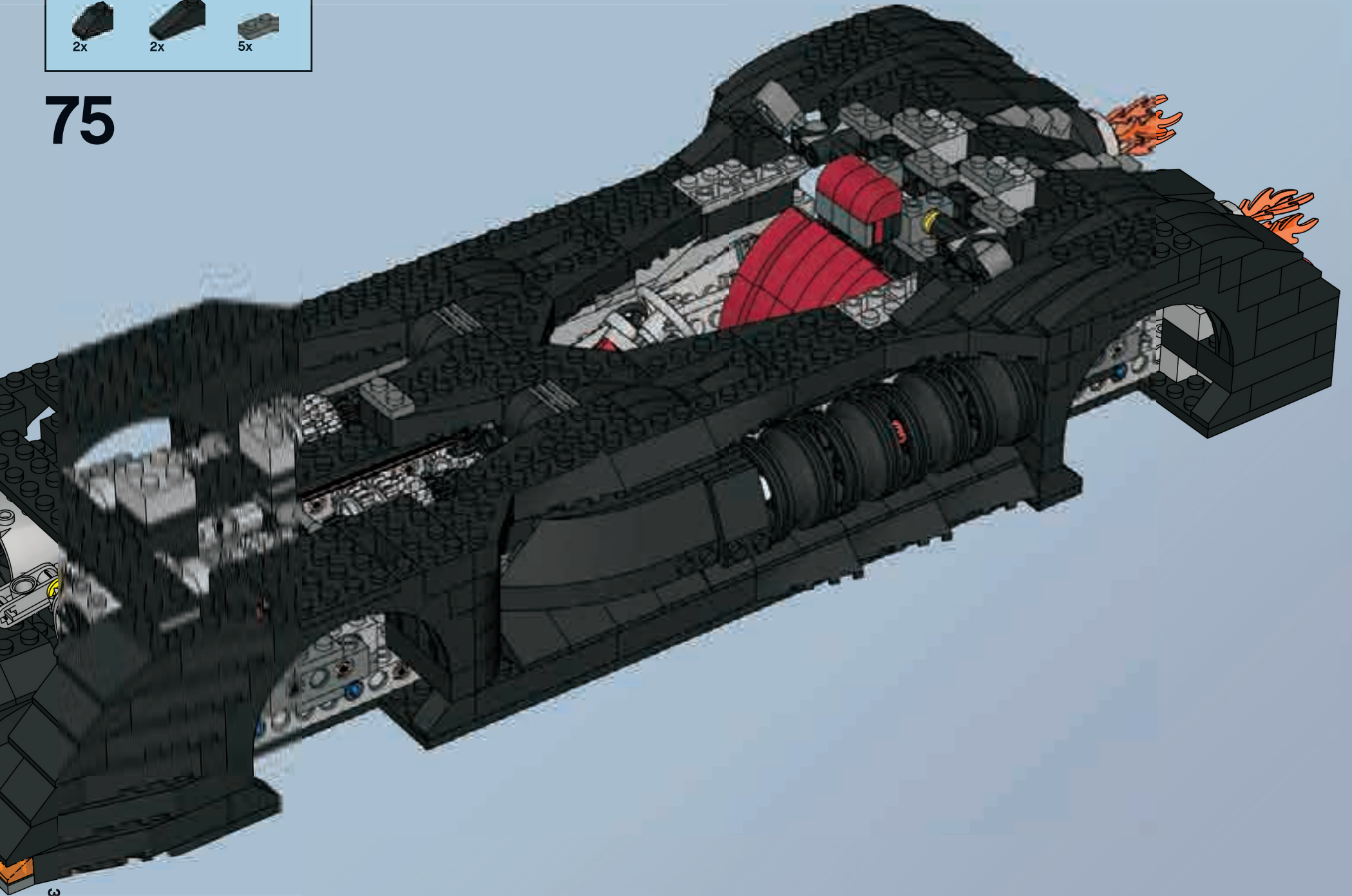



76

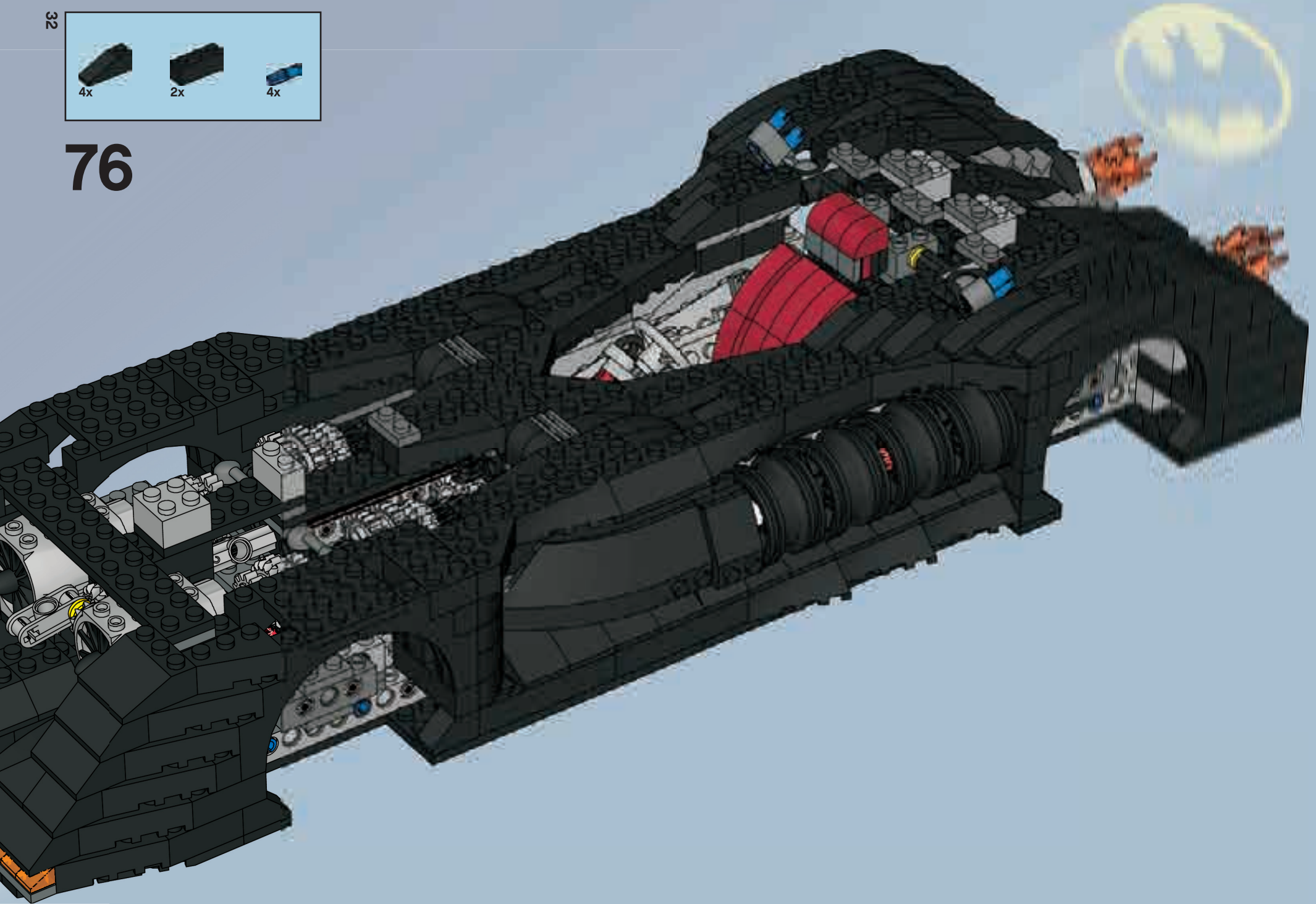

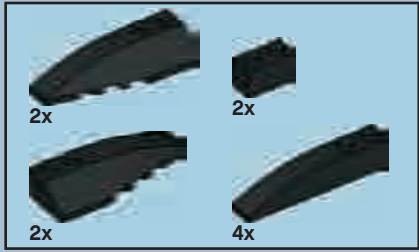

77

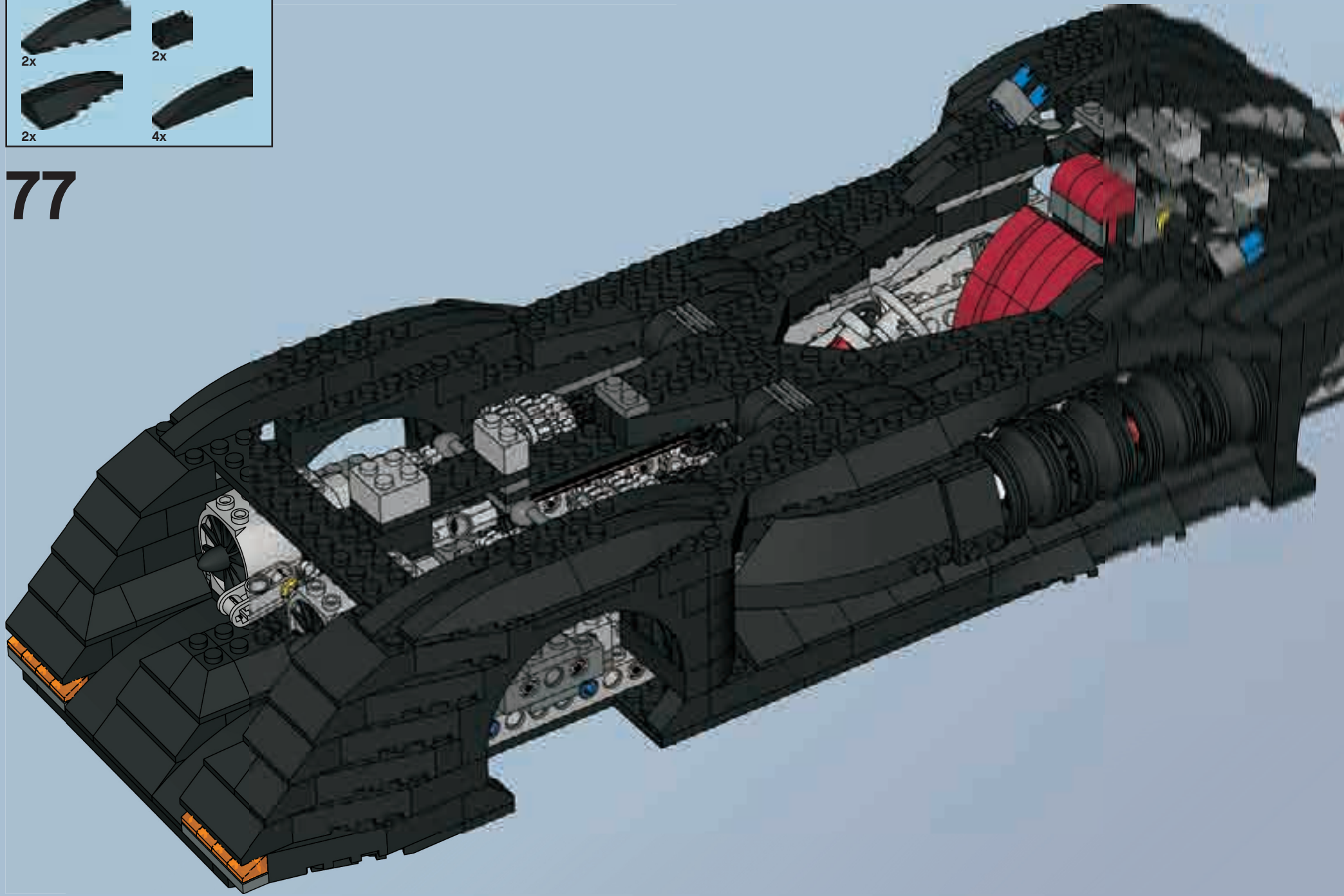

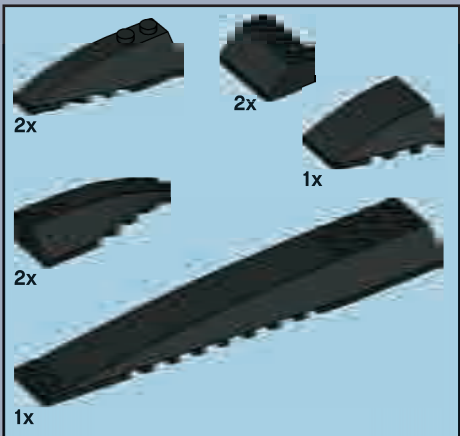

78

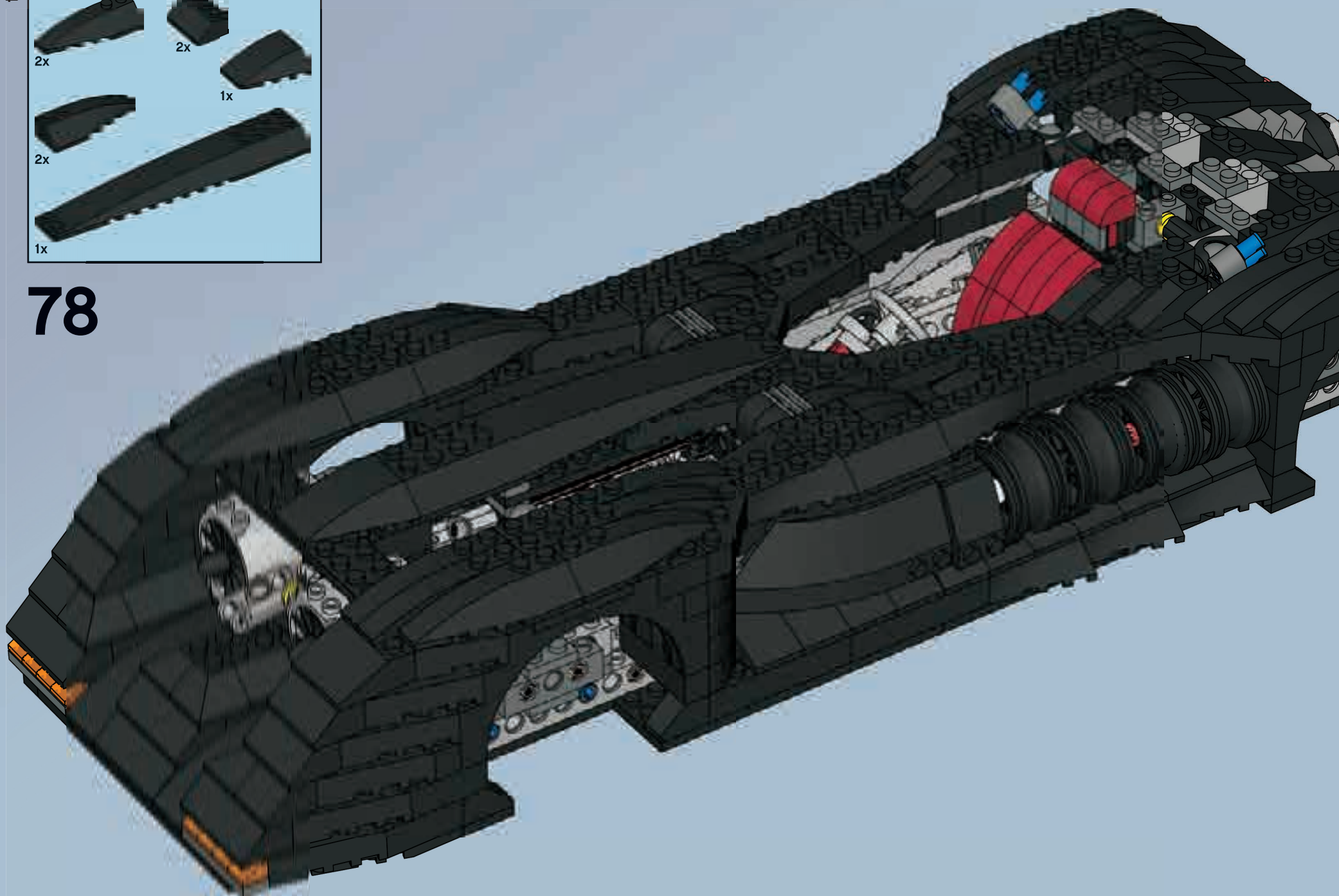

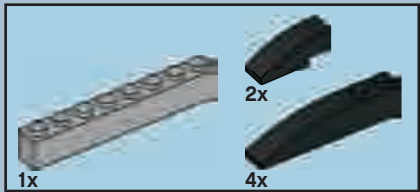

79

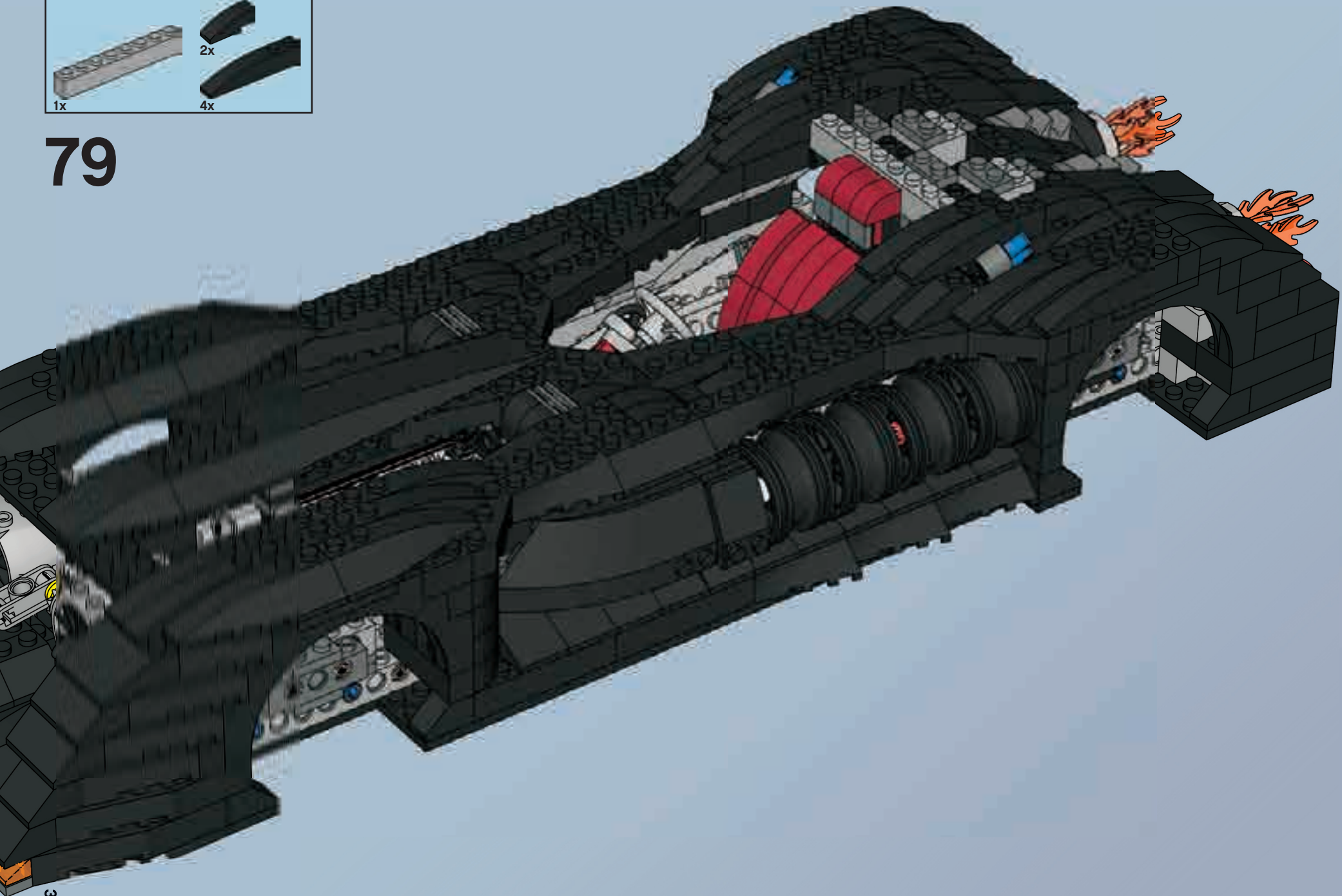



80

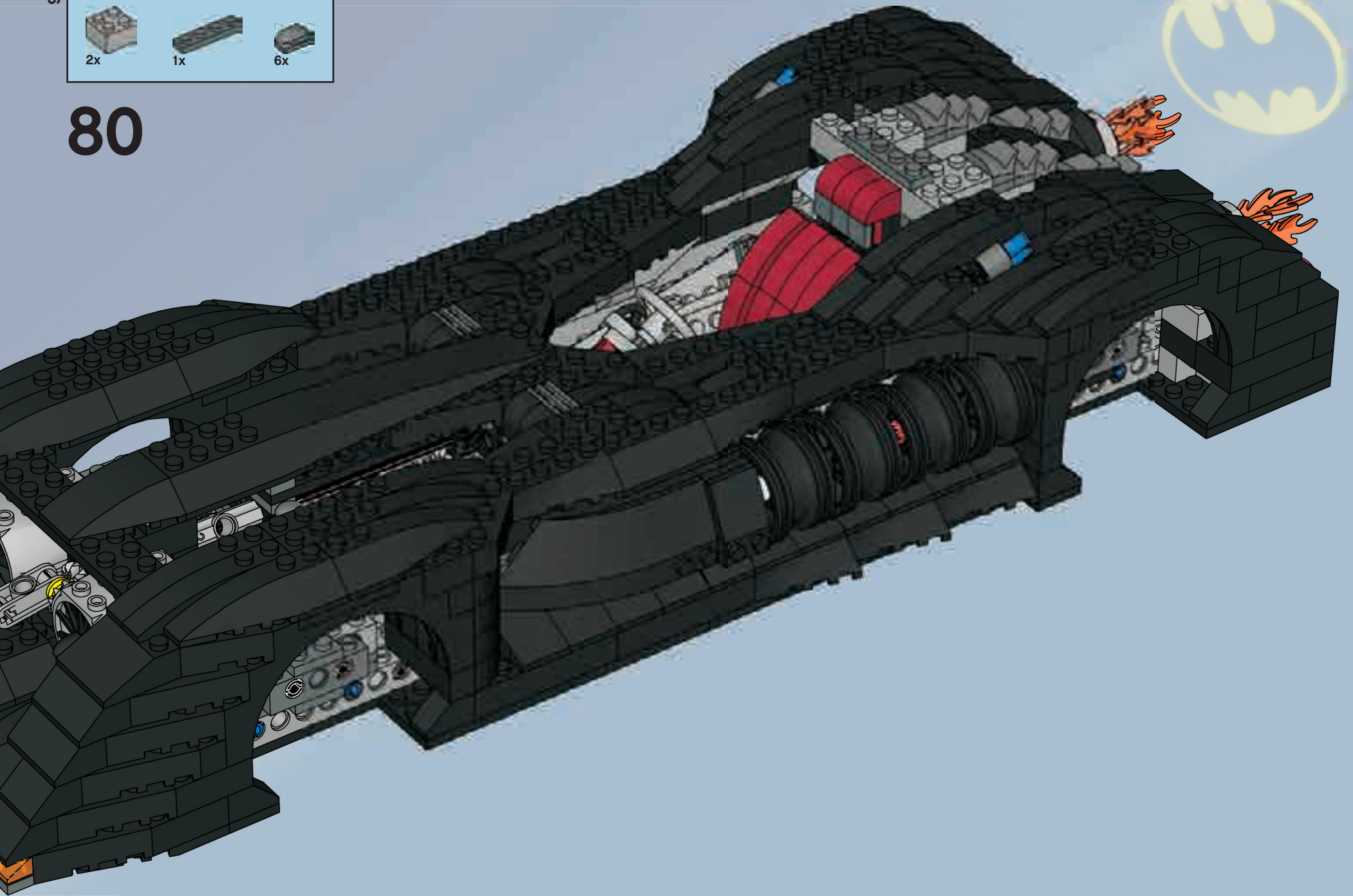



81

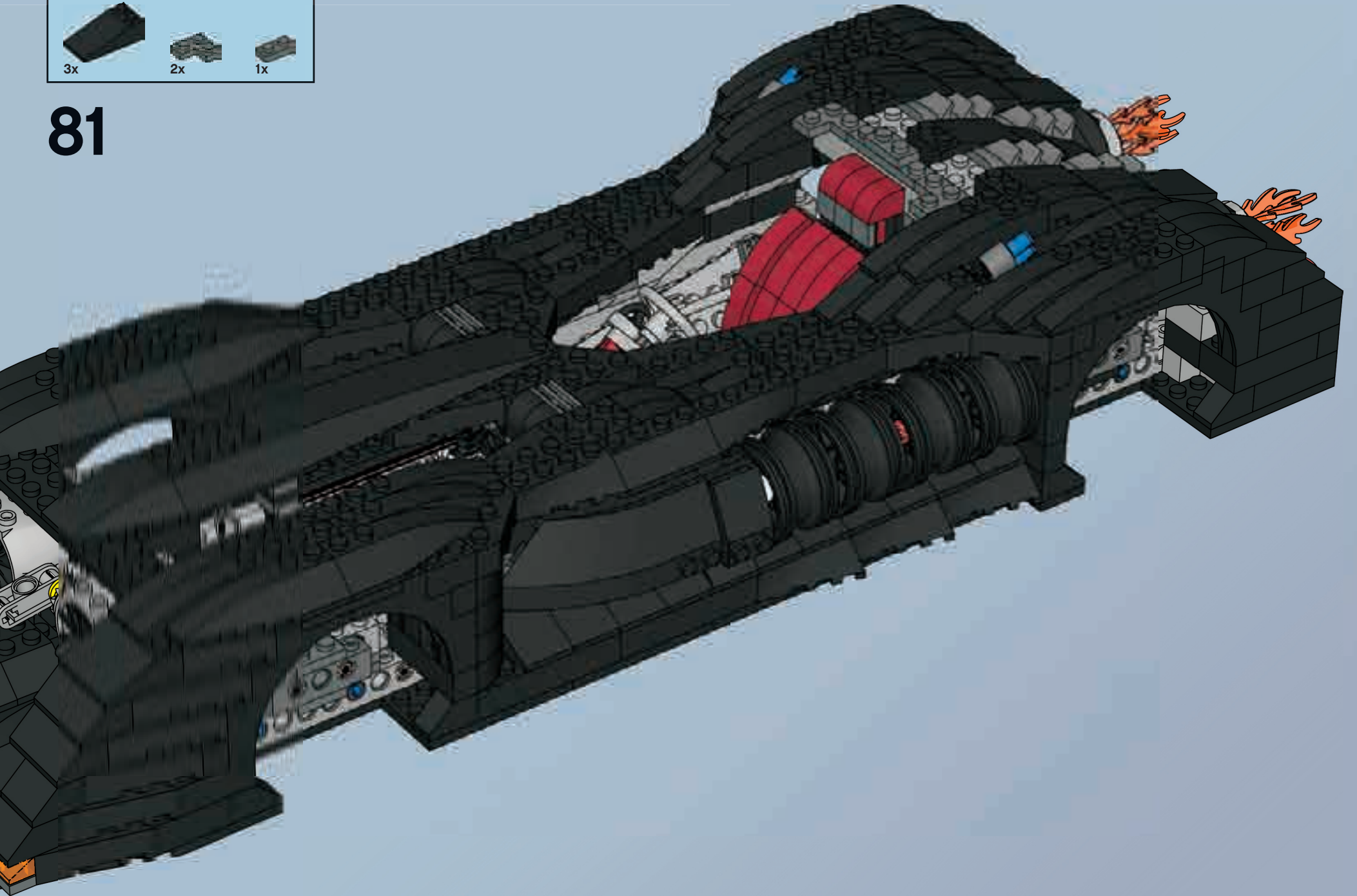

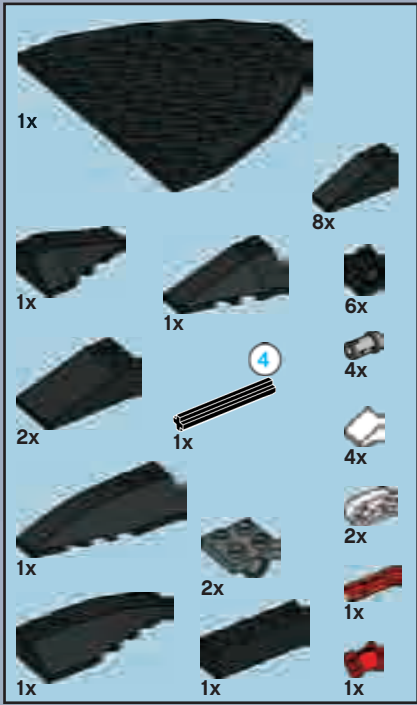

82

1



2



3

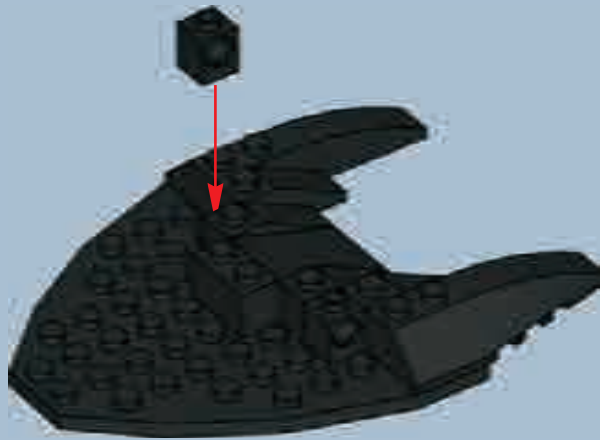

4

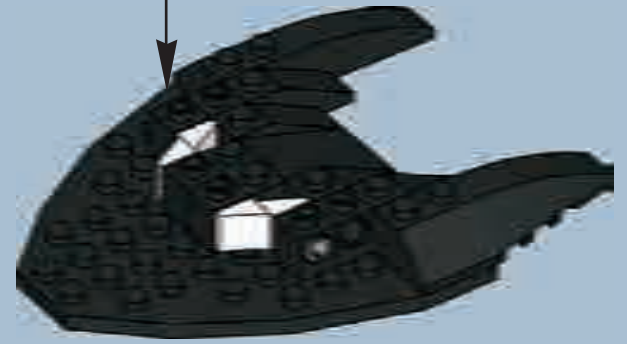

5

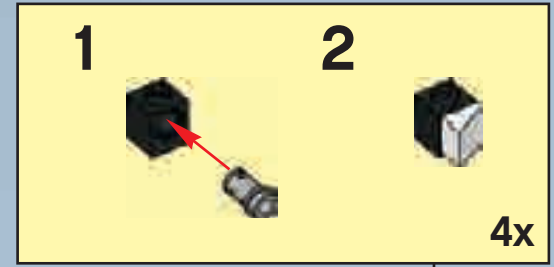

6



7



8



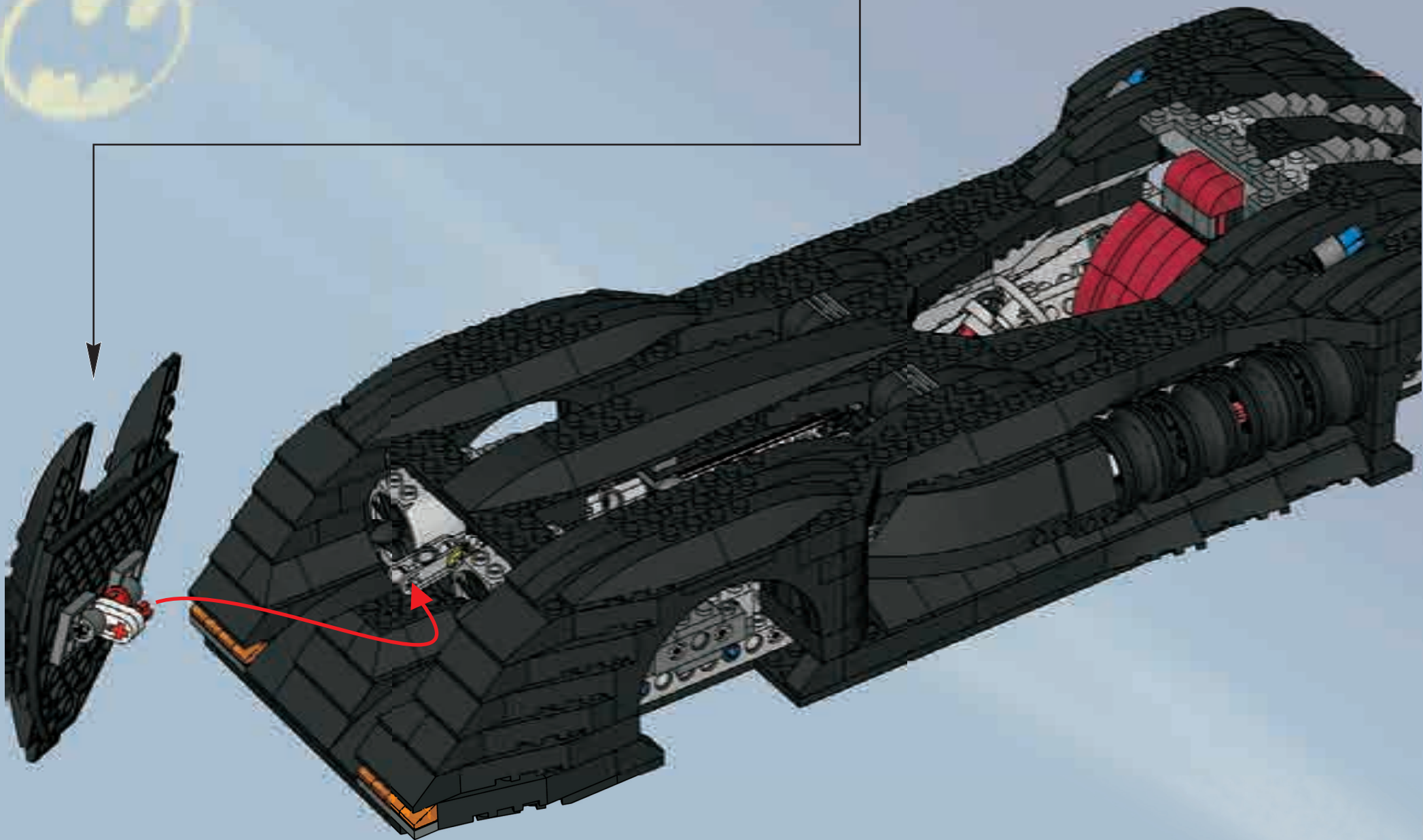



83

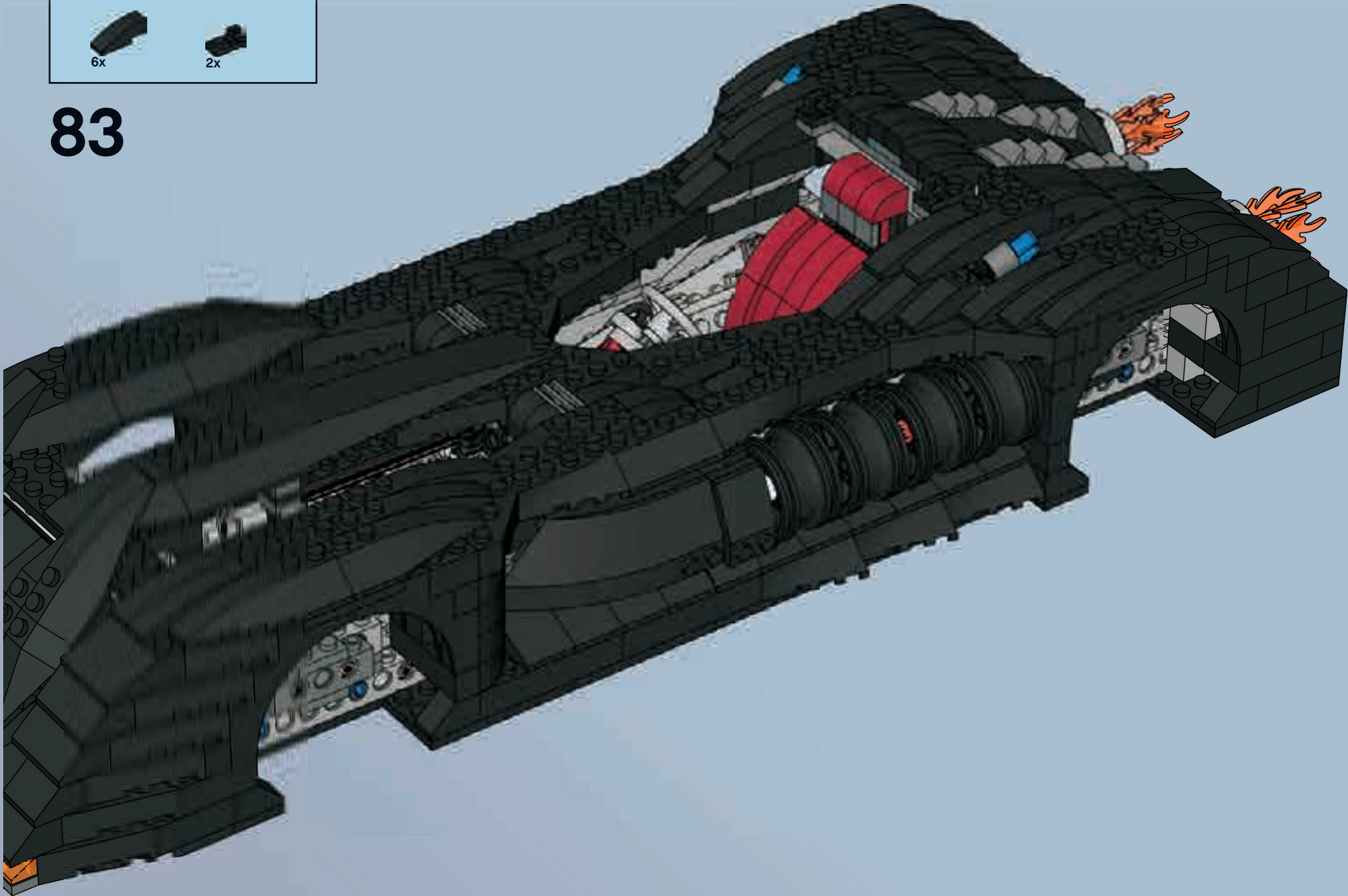

42



84

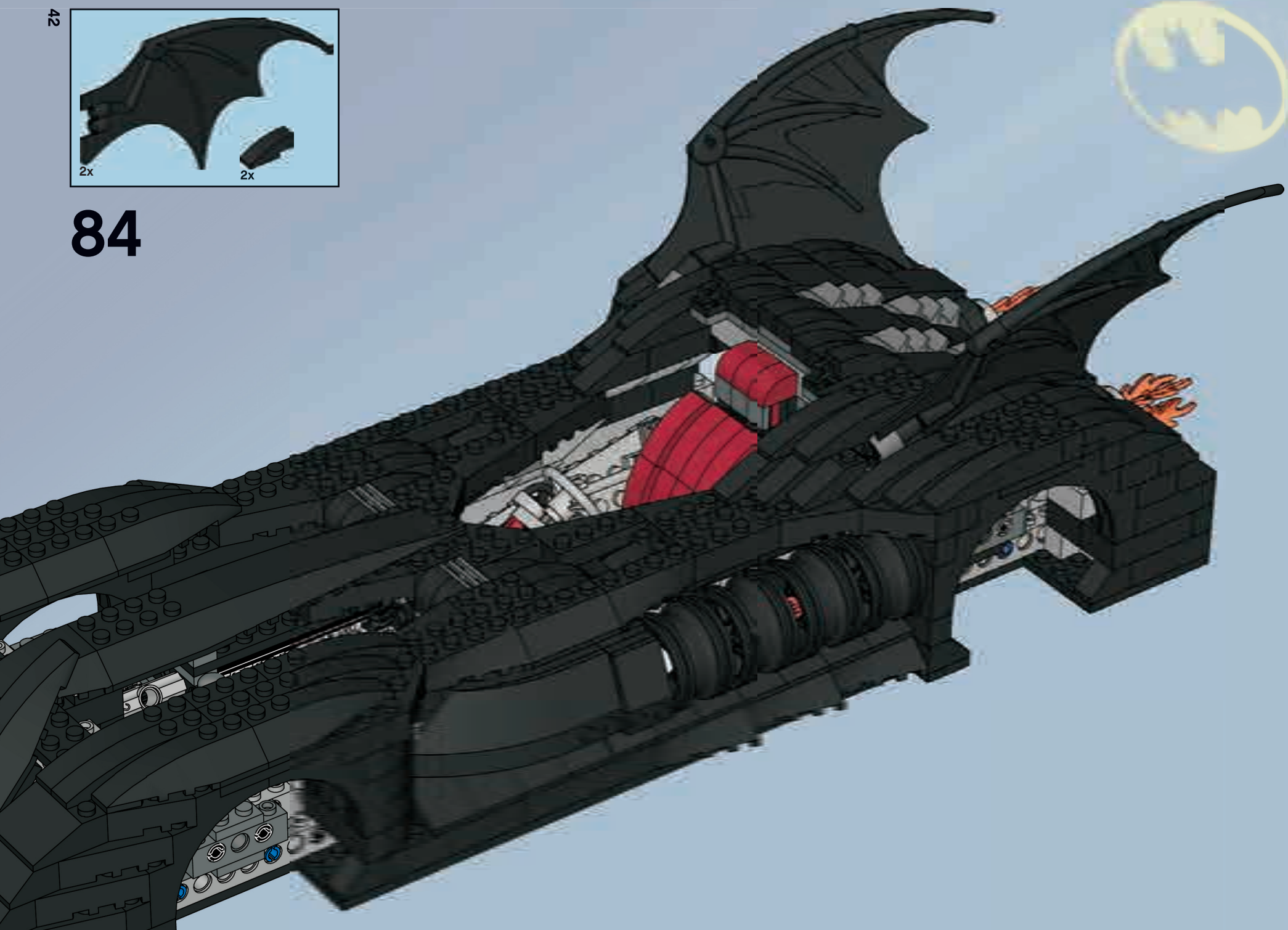

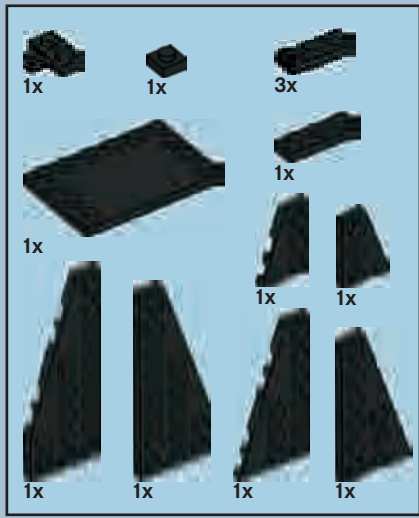

85

2



3



4

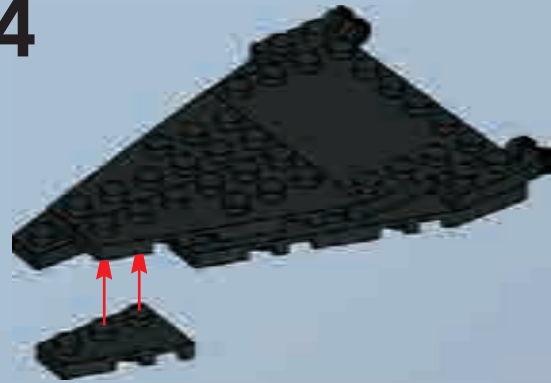

5

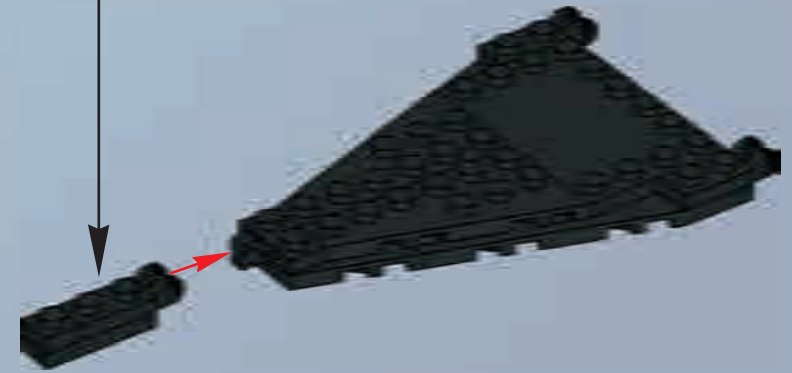
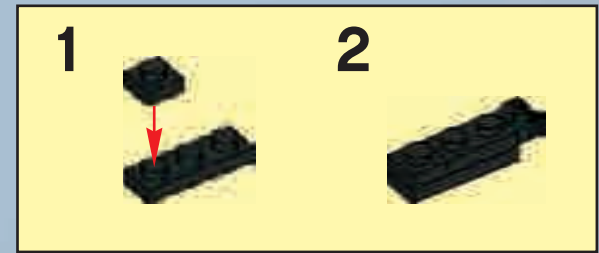

1



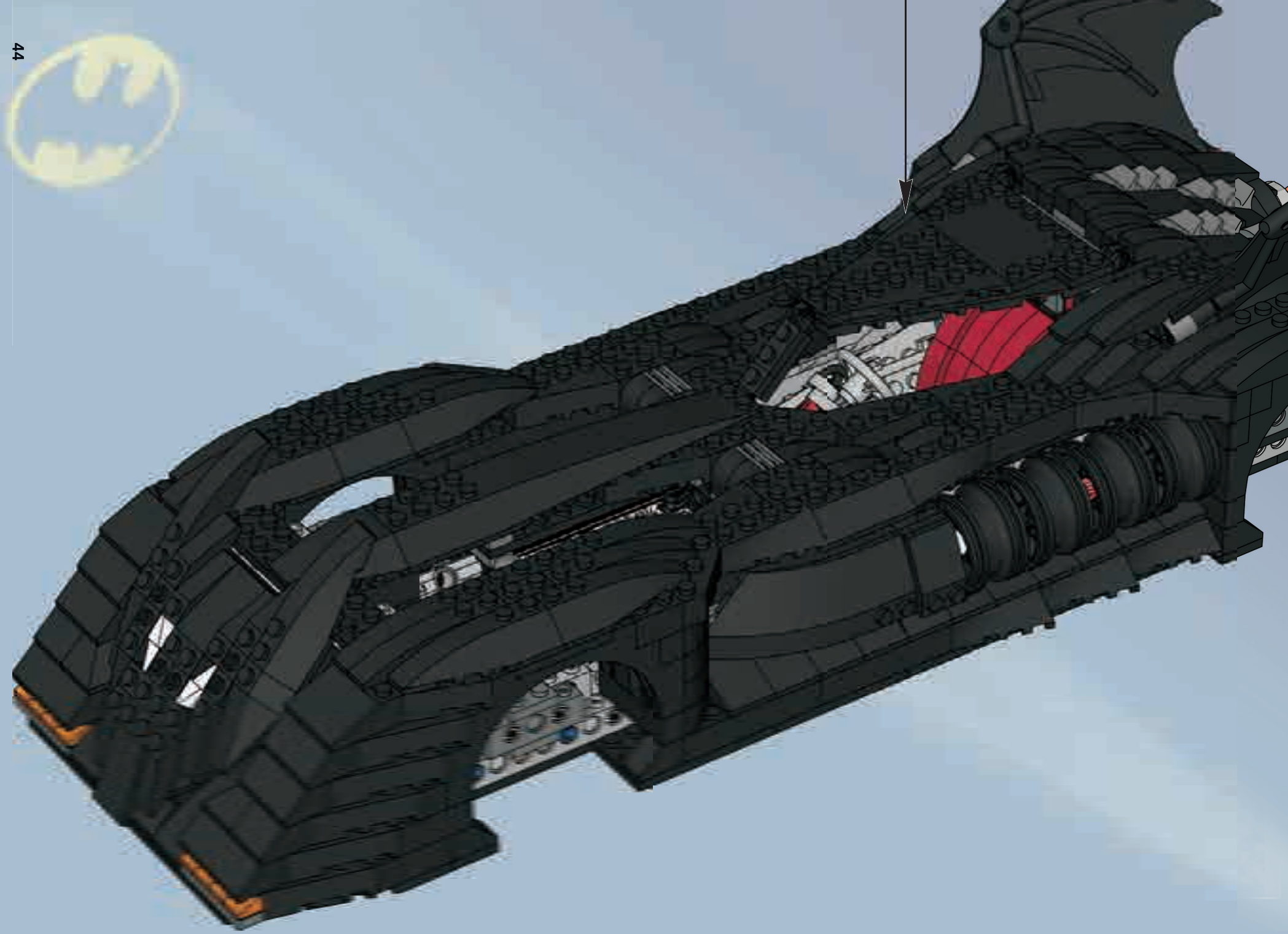



86



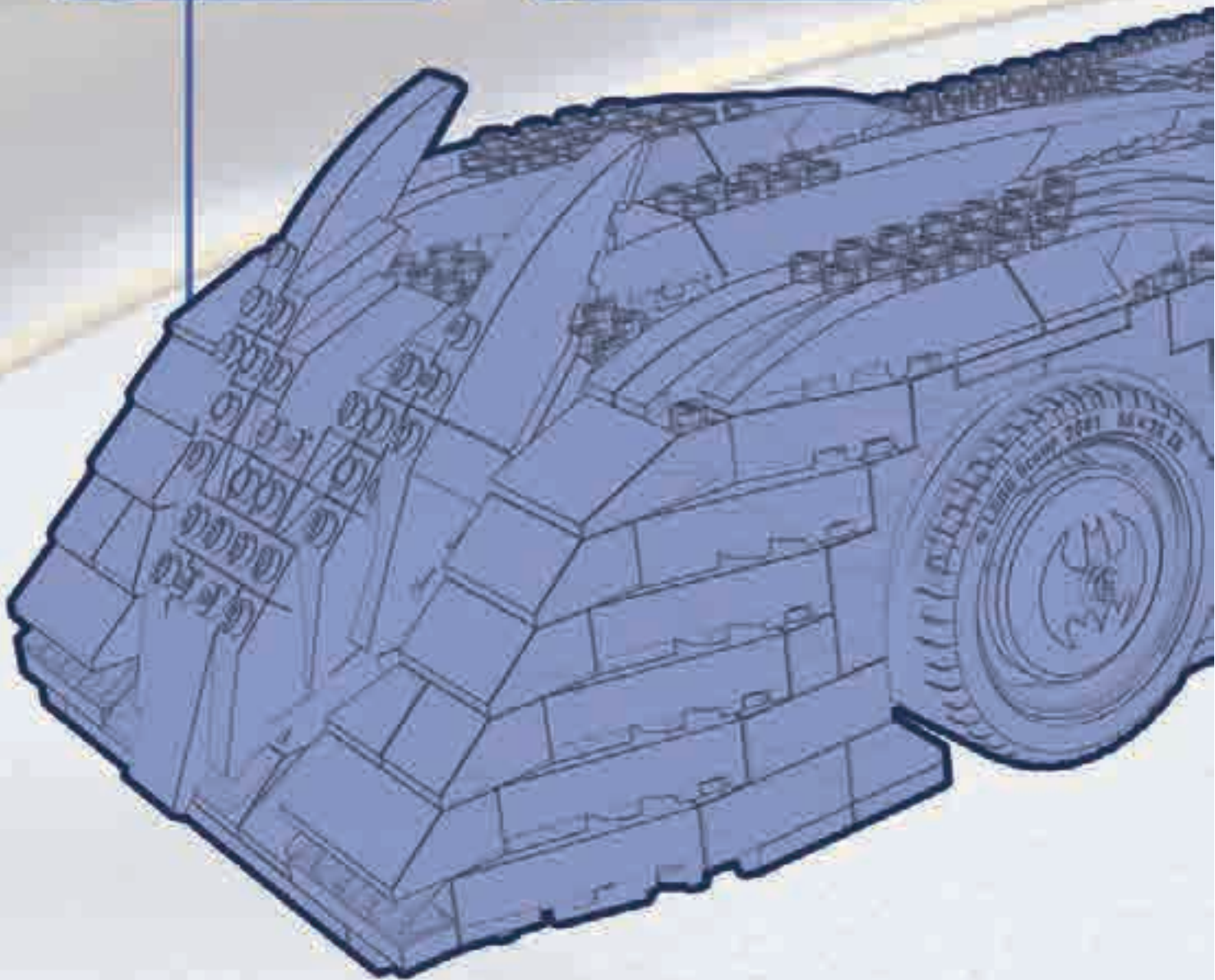

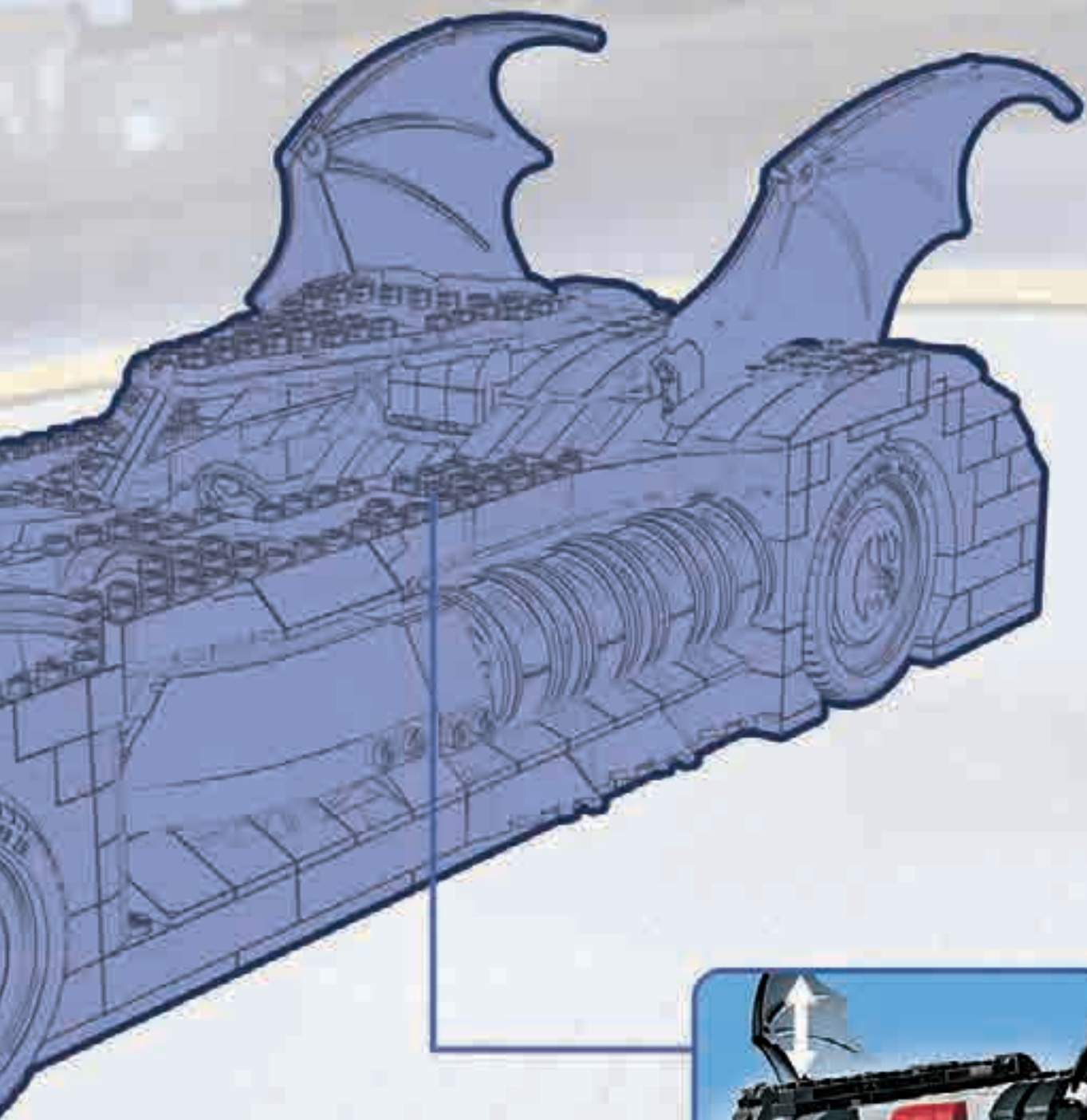

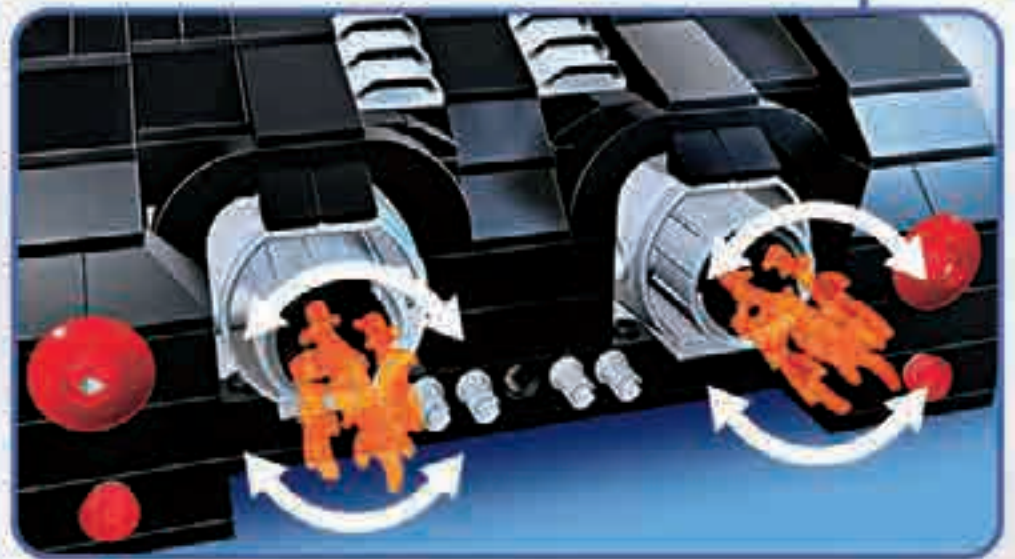
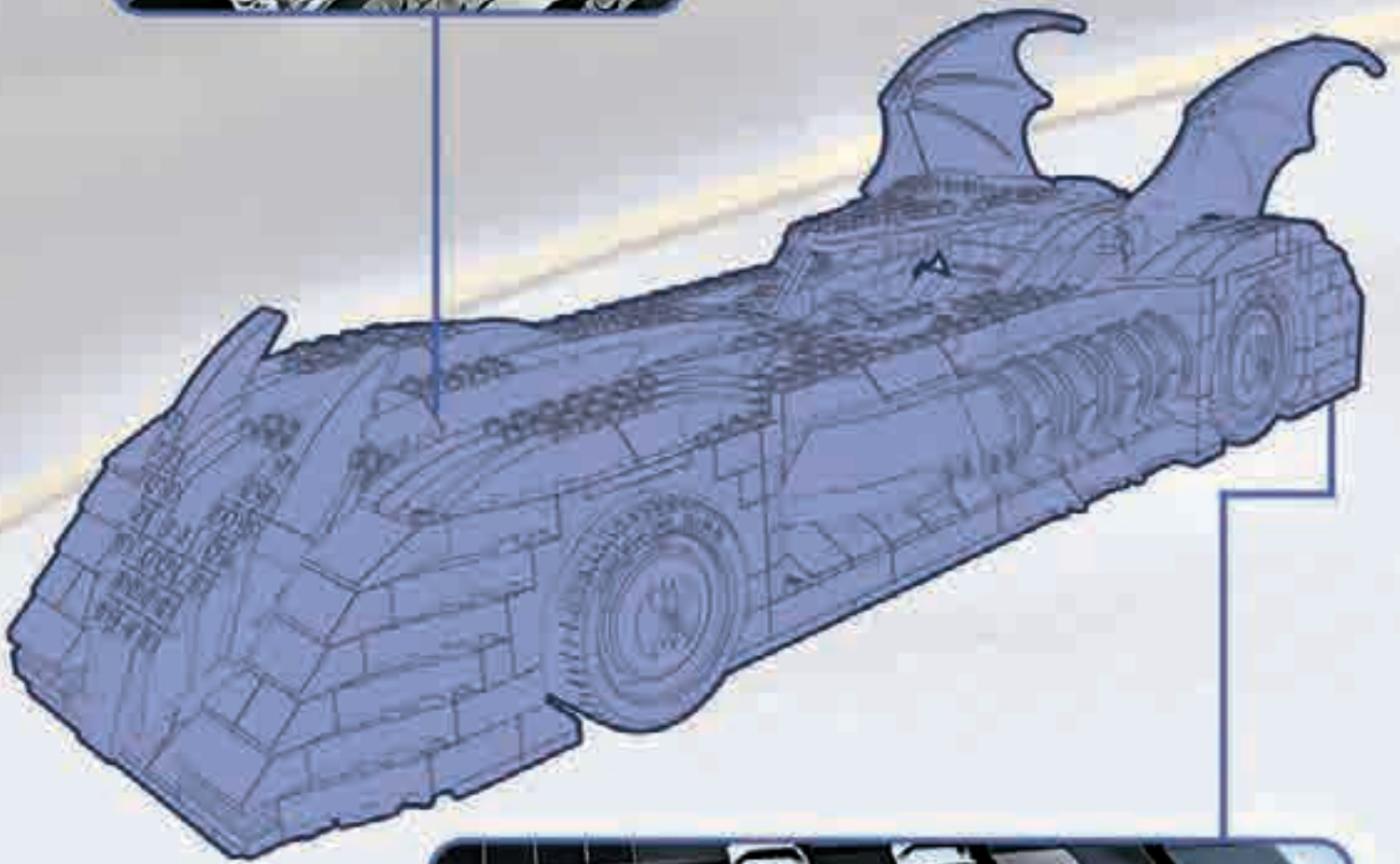

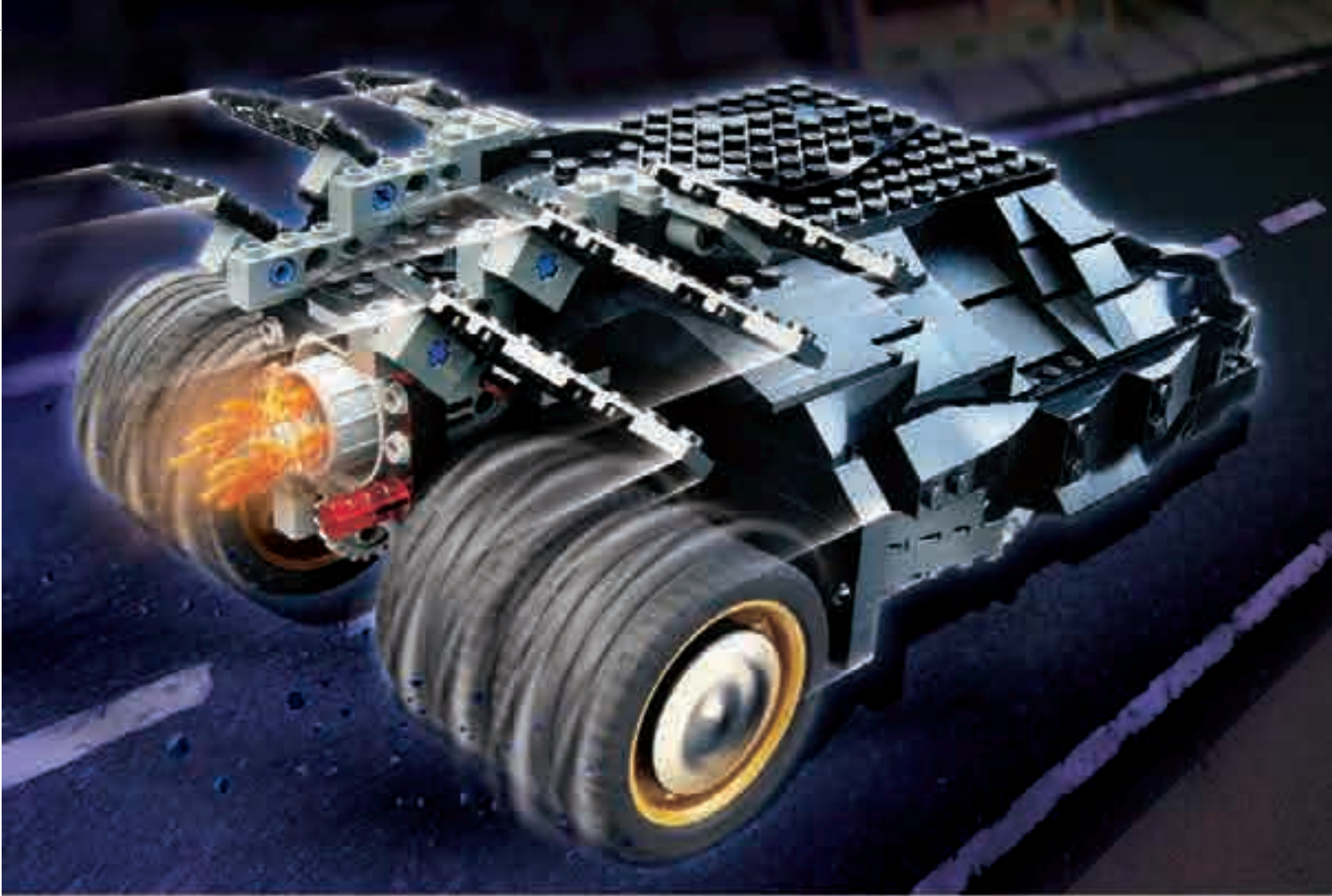



7782

7780

7779

7780

7781



7783

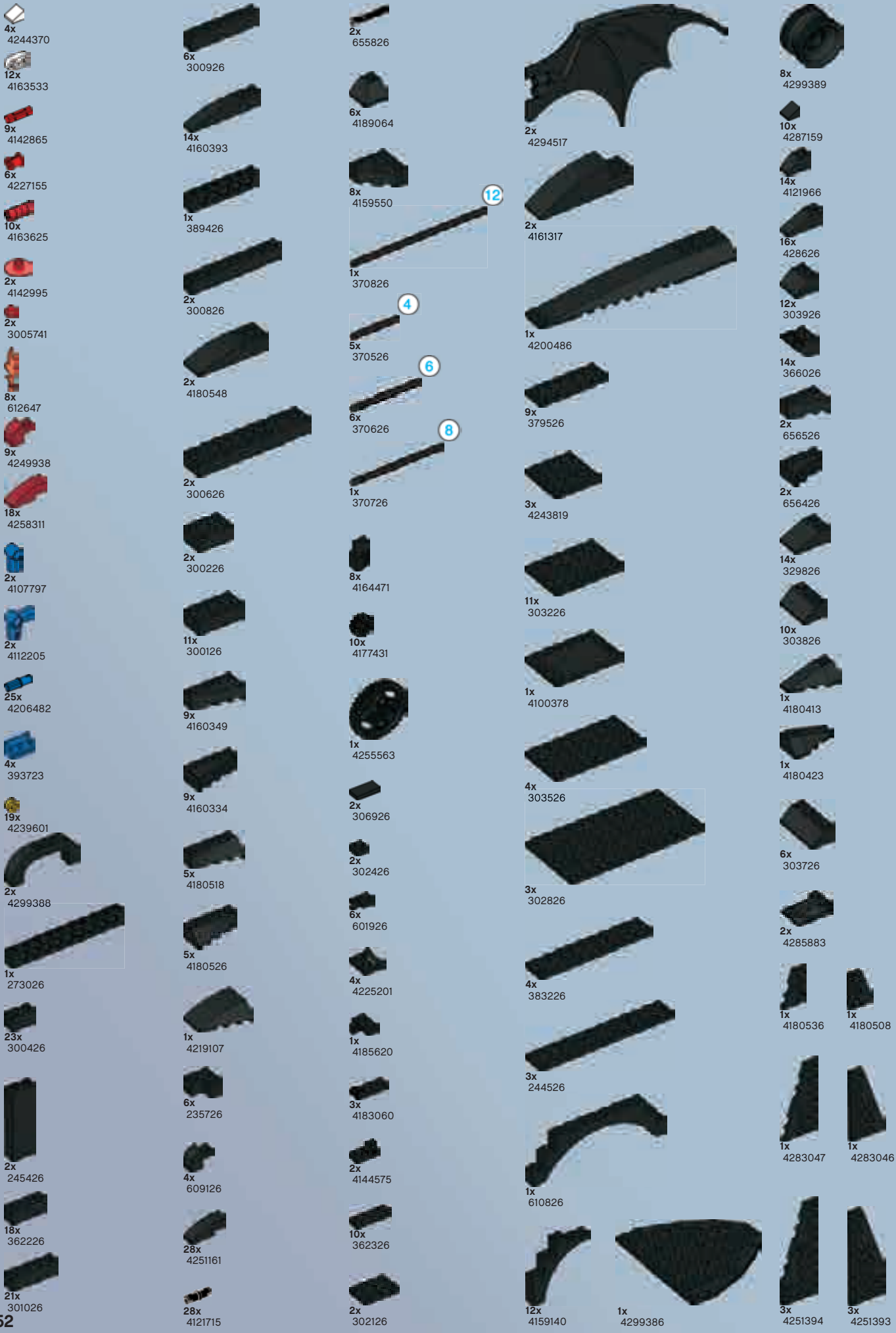

4x 4244370
 12x 4163533
 9x 4142865
 6x 4227155
 10x 4163625
 2x 4142995
 2x 3005741
 8x 612647
 9x 4249938
 18x 4258311
 2x 4107797
 2x 4112205
 25x 4206482
 4x 393723
 19x 4239601
 2x 4299388
 1x 273026
 23x 300426
 2x 245426
 18x 362226
 21x 301026

6x 300926
 14x 4160393
 1x 389426
 2x 300826
 2x 4180548
 2x 300626
 2x 300226
 11x 300126
 9x 4160349
 9x 4160334
 5x 4180518
 5x 4180526
 1x 4219107
 6x 235726
 4x 609126
 28x 4251161
 28x 4121715

2x 655826
 6x 4189064
 8x 4159550
 1x 370826
 5x 370526
 6x 370626
 1x 370726
 8x 4164471
 10x 4177431
 1x 4255563
 2x 306926
 2x 302426
 6x 601926
 4x 4225201
 1x 4185620
 3x 4183060
 2x 4144575
 10x 362326
 2x 302126

2x 4294517
 2x 4161317
 1x 4200486
 9x 379526
 3x 4243819
 11x 303226
 1x 4100378
 4x 303526
 3x 302826
 4x 383226
 3x 244526
 1x 610826
 12x 4159140
 1x 4299386

8x 4299389
 10x 4287159
 14x 4121966
 16x 428626
 12x 303926
 14x 366026
 2x 656526
 2x 656426
 14x 329826
 10x 303826
 1x 4180413
 1x 4180423
 6x 303726
 2x 4285883
 1x 4180536
 1x 4180508
 1x 4283047
 1x 4283046
 3x 4251394
 3x 4251393



21x
4185583



4x
416126



2x
4288241



4x
4298659



5x
4160130



5x
4160108



1x
4286971



1x
4286970



2x
4153044



18x
654126



6x
370026



4x
370226



4x
4283701



2x
394026



2x
4211567



2x
4235786



26x
4211388



7x
4211394



7x
4211393



6x
4211466

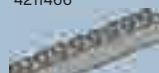

5x
4211392



7x
4211387



2x
4211386



3x
4211795



2x
4211526



4x
4211539



4x
4211807



12x
4211483



4x
4211815

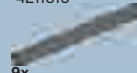

9x
4211805



5x
4211635



1x
4211621



6x
4211565



4x
4211563



4x
4211767



6x
4211628



4x
4211885



2x
4211609



8x
4211369



4x
4211881



4x
4211405



1x
4208988



1x
4209006



4x
4211437



4x
4211489



6x
4211436



1x
4211578



10x
4211705



12x
4211440



10x
4211566



1x
4240416



2x
4211510



2x
4263624



2x
4277928



6x
4210935



4x
4210725



2x
4289258



2x
4210635



9x
4210848



62x
4211063



6x
4211001



9x
4211056



3x
4210998



4x
4211094



11x
4211043



3x
4211065



2x
4210997



13x
4218750



6x
4210631



1x
4210763



2x
4196768



8x
4213607



2x
4210676



8x
4244369



4x
4297499



club



FREE!

Each LEGO Magazine Features...

- Awesome creations by Kids like you!
- Cool Comics & Stories
- Building Tips & Ideas
- Special Offers & Contests to WIN Prizes!

GRATUIT !

Chaque Magazine LEGO offre...

- Des créations épatantes par des jeunes comme toi !
- Des bandes dessinées et des récits super cool
- Des idées de construction
- Des offres spéciales et des concours pour gagner des prix !

Join Today!

Abonne-toi dès aujourd'hui !

1-866-534-6258

www.LEGOclub.com



© 2002 The LEGO Group. All trademarks are the property of their respective owners. LEGO Club is a trademark of The LEGO Group. 80002 The LEGO Group.

YES! I WANT TO JOIN THE LEGO® CLUB!

This coupon is good for 1 **FREE** 2-year Club membership. Additional kids may sign up for \$7.95 in the US and in Canada 10.70 (including taxes).

PLEASE PRINT IN ALL CAPITAL LETTERS

OUI! JOIGNEZ-MOI AU CLUB LEGO® !

Ce coupon est valide pour 1 abonnement **GRATUIT** de 2 ans. Enfants additionnels peuvent s'inscrire pour 10.70 \$ (taxes incluses).

S.V.P. IMPRIMER EN LETTRES MAJUSCULES.

BIC26

Name/Nom _____ Age _____ Français English

Address/Adresse _____ Grande Belgique

City/Ville _____ State/Prov. _____ Postal Code Code Postal _____

E-mail Address/Courriel _____ Date of Birth Date de Naissance _____

Parent's Signature/Signature d'un parent _____



Mail to/Poster à:
LEGO Club
P. O. Box 1157
Enfield, CT
06083-1157



Offre limitée en nombre et disponible jusqu'à épuisement des stocks. Offre limitée à une seule inscription par famille/groupe de personnes. Please allow 4-6 weeks for delivery of your first mailing. Offre limitée pour résidents au US et Canada. Photocopier la section des accords. Offre limitée à deux abonnements par famille/groupe de personnes. Allow 4-6 semaines pour la première livraison.



SHOP at HOME

The World's Biggest LEGO Shop!



For a Free Catalog
in the U.S. and Canada,
call toll-free:

1-866-534-6737

Or go online:

www.LEGOshop.com/catalog

Pour obtenir un Catalogue
GRATUIT aux États-Unis
et au Canada,

téléphonez sans frais au :

1-866-534-6737

Ou venez en ligne sur :

www.LEGOshop.com/catalog

Any questions
regarding your new
LEGO product, please

contact:

Customer
Service | Service

Consommateurs |

Servicio :



1-800-422-5346

or

www.lego.com/service

LEGO and LEGO Shop at Home are trademarks of the LEGO Group. © 2006 The LEGO Group.

FREE LEGO® Catalog!

Please print with a pen in capital letters.

First Name
Prénom

Last Name
Nom

Address
Adresse

City
Ville

State
Prov.

Zip Code
Code Postal

Phone (optional)
No. de téléphone
(optionnel)

Email (optional)
Courriel (optionnel)

Check below / Indiquer ci-dessous

I speak English

Je parle Français

Boy/Garçon

Girl/Fille



U.S. and Canada only
É. U. et Canada seulement

Please allow 2-4 weeks for delivery.

Veuillez s.v.p. attendre 2 à 4 semaines pour l'expédition.

Mail to/Poster à:



SHOP at HOME

P. O. Box 1221

Enfield, CT 06083-1221





LEGO and the LEGO logo are trademarks of the/son des marques de commerce de/son marcas registradas de LEGO Group. ©2006 The LEGO Group. 4496458

BATMAN and all related characters and elements are trademarks of and/ BATMAN et tous les personnages qui s'y rapportent sont des marques de commerce de et/BATMAN, todos los personajes incluidos y elementos son marcas registradas de y © DC Comics. TM & © Warner Bros. Entertainment Inc. (s06)



Image	Qty	Item No	Description	MID
Regular Items:				
Parts:				
+	6	30374	Light Bluish Gray Bar 4L (Lightsaber Blade / Wand) Catalog: Parts: Bar 6116608 or 4211628	PG
+	2	6190	Dark Bluish Gray Bar 1 x 3 with 2 Stud Receptacles (Radio Handle, Phone Handset) Catalog: Parts: Bar 4210676	PG
+	2	44728	Dark Bluish Gray Bracket 1 x 2 - 2 x 2 Catalog: Parts: Bracket 6117972 or 6048854 or 4210893 or 4277928	PG
+	23	3004	Black Brick 1 x 2 Catalog: Parts: Brick 300426	PG
+	26	3004	Light Bluish Gray Brick 1 x 2 Catalog: Parts: Brick 4211388	PG
+	2	2454	Black Brick 1 x 2 x 5 - Blocked Open Studs or Hollow Studs Catalog: Parts: Brick 245426	PG
+	18	3622	Black Brick 1 x 3 Catalog: Parts: Brick 362226	PG
+	21	3010	Black Brick 1 x 4 Catalog: Parts: Brick 301026	PG
+	7	3010	Light Bluish Gray Brick 1 x 4 Catalog: Parts: Brick 4211394	PG
+	6	3009	Black Brick 1 x 6 Catalog: Parts: Brick 300926	PG
+	7	3009	Light Bluish Gray Brick 1 x 6 Catalog: Parts: Brick 4211393	PG

+	 *	2	3008	Black Brick 1 x 8 Catalog: Parts: Brick 300826	PG
---	---	---	----------------------	---	--------------------

+	 *	5	3008	Light Bluish Gray Brick 1 x 8 Catalog: Parts: Brick 4211392	PG
---	--	---	----------------------	--	--------------------

+	 *	7	3003	Light Bluish Gray Brick 2 x 2 Catalog: Parts: Brick 4211387	PG
---	--	---	----------------------	--	--------------------

+	 *	6	2357	Black Brick 2 x 2 Corner Catalog: Parts: Brick 235726	PG
---	--	---	----------------------	--	--------------------

+	 *	2	3002	Black Brick 2 x 3 Catalog: Parts: Brick 300226	PG
---	--	---	----------------------	---	--------------------

+	 *	2	3002	Light Bluish Gray Brick 2 x 3 Catalog: Parts: Brick 4211386	PG
---	---	---	----------------------	--	--------------------

+	 *	11	3001	Black Brick 2 x 4 Catalog: Parts: Brick 300126	PG
---	--	----	----------------------	---	--------------------





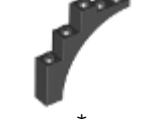





+	 *	3	2456	Light Bluish Gray Brick 2 x 6 Catalog: Parts: Brick 4211795	PG
---	--	---	----------------------	--	--------------------









+	 *	2	3006	Black Brick 2 x 10 Catalog: Parts: Brick 4617860 or 300626	PG
---	--	---	----------------------	---	--------------------













+	 *	12	2339	Black Brick, Arch 1 x 5 x 4 - Continuous Bow Catalog: Parts: Brick, Arch 6075062 or 4519925 or 4159140	PG
---	--	----	----------------------	---	--------------------











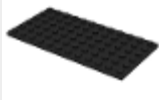

+	 *	2	6183	Black Brick, Arch 1 x 6 x 2 Curved Top Catalog: Parts: Brick, Arch 6132770 or 4144527 or 4299388	PG
---	--	---	----------------------	---	--------------------













+	 *	1	6108	Black Brick, Arch 1 x 12 x 3 Catalog: Parts: Brick, Arch 610826	PG
---	--	---	----------------------	--	--------------------











+	 *	4	6091	Black Brick, Modified 1 x 2 x 1 1/3 with Curved Top Catalog: Parts: Brick, Modified 6184784 or 609126	PG
+	 *	9	6091	Dark Red Brick, Modified 1 x 2 x 1 1/3 with Curved Top Catalog: Parts: Brick, Modified 4539082 or 4162206 or 4249938	PG
+	 *	13	47458	Dark Bluish Gray Brick, Modified 1 x 2 x 2/3 No Studs, Wing End Catalog: Parts: Brick, Modified 4218750	PG
+	 *	4	30414	Dark Bluish Gray Brick, Modified 1 x 4 with 4 Studs on 1 Side Catalog: Parts: Brick, Modified 4210725	PG
+	 *	2	47456	Black Brick, Modified 2 x 3 x 2/3 Two Studs, Wing End Catalog: Parts: Brick, Modified 4285883	PG
+	 *	2	3941	Light Bluish Gray Brick, Round 2 x 2 with Axle Hole Catalog: Parts: Brick, Round 4211526	PG
+	 *	8	3063	Black Brick, Round Corner 2 x 2 Macaroni with Stud Notch Catalog: Parts: Brick, Round 4164471	PG
+	 *	2	4740	Trans-Red Dish 2 x 2 Inverted (Radar) Catalog: Parts: Dish 6245303 or 4142995	PG
+	 *	4	3960pb017	Black Dish 4 x 4 Inverted (Radar) with Solid Stud with Black Bat on Gold Background Batman Logo (Bat Signal) Pattern Catalog: Parts: Dish, Decorated 4298659	PG
+	 *	2	51342	Black Dragon Wing 19 x 11 Catalog: Parts: Animal, Body Part 6101956 or 4294517	PG
+	 *	4	43121	Light Bluish Gray Engine, Large Catalog: Parts: Aircraft 4211767	PG
+	 *	2	x577	Black Engine, Large, Center, 10 Blades Catalog: Parts: Aircraft 4192455 or 6088638 or 4288241	PG













+		4	3937	Blue Hinge Brick 1 x 2 Base	PG
	*			Catalog: Parts: Hinge 393723	
+		4	6134	Light Bluish Gray Hinge Brick 2 x 2 Top	PG
	*			Catalog: Parts: Hinge 4211881	
+		1	44567a	Black Hinge Plate 1 x 2 Locking with 1 Finger on Side with Bottom Groove	PG
	*			Catalog: Parts: Hinge 4185620	
+		2	30383	Black Hinge Plate 1 x 2 Locking with 1 Finger On Top	PG
	*			Catalog: Parts: Hinge 3038326 or 4142992 or 4144575	
+		3	44302a	Black Hinge Plate 1 x 2 Locking with 2 Fingers on End with Bottom Groove	PG
	*			Catalog: Parts: Hinge 4183060	
+		2	3024	Black Plate 1 x 1	PG
	*			Catalog: Parts: Plate 302426	
+		62	3023	Dark Bluish Gray Plate 1 x 2	PG
	*			Catalog: Parts: Plate 4211063	
+		10	3623	Black Plate 1 x 3	PG
	*			Catalog: Parts: Plate 362326	
+		6	3710	Dark Bluish Gray Plate 1 x 4	PG
	*			Catalog: Parts: Plate 4211001	
+		9	3666	Dark Bluish Gray Plate 1 x 6	PG
	*			Catalog: Parts: Plate 4211056	
+		3	3460	Dark Bluish Gray Plate 1 x 8	PG
	*			Catalog: Parts: Plate 4210998	
+		4	3022	Dark Bluish Gray Plate 2 x 2	PG
	*			Catalog: Parts: Plate 4211094	

+	 *	2	2420	Dark Bluish Gray Plate 2 x 2 Corner Catalog: Parts: Plate 4210635	PG
+	 *	2	3021	Black Plate 2 x 3 Catalog: Parts: Plate 302126	PG
+	 *	11	3021	Dark Bluish Gray Plate 2 x 3 Catalog: Parts: Plate 4211043	PG
+	 *	3	3020	Dark Bluish Gray Plate 2 x 4 Catalog: Parts: Plate 4211065	PG
+	 *	9	3795	Black Plate 2 x 6 Catalog: Parts: Plate 379526	PG
+	 *	2	3034	Dark Bluish Gray Plate 2 x 8 Catalog: Parts: Plate 4210997	PG
+	 *	4	3832	Black Plate 2 x 10 Catalog: Parts: Plate 383226	PG
+	 *	3	2445	Black Plate 2 x 12 Catalog: Parts: Plate 244526	PG
+	 *	3	3031	Black Plate 4 x 4 Catalog: Parts: Plate 303126 or 4243819	PG
+	 *	11	3032	Black Plate 4 x 6 Catalog: Parts: Plate 303226	PG
+	 *	4	3035	Black Plate 4 x 8 Catalog: Parts: Plate 303526	PG
+	 *	4	3033	Light Bluish Gray Plate 6 x 10 Catalog: Parts: Plate 4211405	PG

+	 *	3	3028	Black Plate 6 x 12 Catalog: Parts: Plate 302826	PG
+	 *	6	6019	Black Plate, Modified 1 x 1 with Clip Horizontal (thick open U clip) Catalog: Parts: Plate, Modified 601926	PG
+	 *	4	48336	Black Plate, Modified 1 x 2 with Handle on Side - Closed Ends Catalog: Parts: Plate, Modified 4225201	PG
+	 *	2	2444	Dark Bluish Gray Plate, Modified 2 x 2 with Pin Hole Catalog: Parts: Plate, Modified 4196768	PG
+	 *	2	4073	Trans-Red Plate, Round 1 x 1 Catalog: Parts: Plate, Round 6208450 or 3005741	PG
+	 *	21	30363	Black Slope 18 4 x 2 Catalog: Parts: Slope 4185583	PG
+	 *	10	54200	Black Slope 30 1 x 1 x 2/3 Catalog: Parts: Slope 4287159 or 4504382	PG
+	 *	8	54200	Trans-Orange Slope 30 1 x 1 x 2/3 Catalog: Parts: Slope 6245265 or 4244369	PG
+	 *	4	54200	White Slope 30 1 x 1 x 2/3 Catalog: Parts: Slope 4244370 or 4504369	PG
+	 *	16	4286	Black Slope 33 3 x 1 Catalog: Parts: Slope 428626	PG
+	 *	14	3298	Black Slope 33 3 x 2 Catalog: Parts: Slope 329826	PG
+	 *	4	4161	Black Slope 33 3 x 3 Catalog: Parts: Slope 416126	PG

+		14	3040	Black Slope 45 2 x 1 Catalog: Parts: Slope 304026 or 4121966	PG
	*				
+		12	3039	Black Slope 45 2 x 2 Catalog: Parts: Slope 303926	PG
	*				
+		6	3045	Black Slope 45 2 x 2 Double Convex Catalog: Parts: Slope 304526 or 4189064	PG
	*				
+		10	3038	Black Slope 45 2 x 3 Catalog: Parts: Slope 303826	PG
	*				
+		6	3037	Black Slope 45 2 x 4 Catalog: Parts: Slope 303726	PG 1 
	*				
+		28	50950	Black Slope, Curved 3 x 1 Catalog: Parts: Slope, Curved 4251161	PG
	*				
+		18	50950	Dark Red Slope, Curved 3 x 1 Catalog: Parts: Slope, Curved 4541546 or 4258311	PG
	*				
+		14	42022	Black Slope, Curved 6 x 1 Catalog: Parts: Slope, Curved 4160393	PG
	*				
+		2	44126	Black Slope, Curved 6 x 2 Catalog: Parts: Slope, Curved 4180548	PG
	*				
+		2	41766	Black Slope, Curved 8 x 2 x 2 Catalog: Parts: Slope, Curved 4544499 or 4161317	PG
	*				
+		4	4287	Light Bluish Gray Slope, Inverted 33 3 x 1 Catalog: Parts: Slope, Inverted 4211489	PG
	*				
+		4	3665	Light Bluish Gray Slope, Inverted 45 2 x 1 Catalog: Parts: Slope, Inverted 4211437	PG
	*				

+	 *	14	3660	Black Slope, Inverted 45 2 x 2 Catalog: Parts: Slope, Inverted 366026	PG
+	 *	6	3660	Light Bluish Gray Slope, Inverted 45 2 x 2 Catalog: Parts: Slope, Inverted 4211436	PG
+	 *	2	3940b	Black Support 2 x 2 x 2 Stand with Complete Hole Catalog: Parts: Support 6106280 or 394026	PG
+	 *	6	3713	Red Technic Bush Catalog: Parts: Technic 6271820 or 4227155	PG
+	 *	19	4265c	Yellow Technic Bush 1/2 Smooth Catalog: Parts: Technic 6271167 or 4239601 or 3212324	PG
+	 *	2	2853	Light Bluish Gray Technic Engine Crankshaft Catalog: Parts: Technic 4211609 or 2853194	PG
+	 *	9	32062	Red Technic, Axle 2 Notched Catalog: Parts: Technic, Axle 4142865	PG
+	 *	4	4519	Light Bluish Gray Technic, Axle 3 Catalog: Parts: Technic, Axle 4211815	PG
+	 *	5	3705	Black Technic, Axle 4 Catalog: Parts: Technic, Axle 370526	PG
+	 *	6	3706	Black Technic, Axle 6 Catalog: Parts: Technic, Axle 370626	PG
+	 *	9	44294	Light Bluish Gray Technic, Axle 7 Catalog: Parts: Technic, Axle 44294194 or 4211805	PG
+	 *	1	3707	Black Technic, Axle 8 Catalog: Parts: Technic, Axle 370726	PG

+	 *	1	3708	Black Technic, Axle 12 Catalog: Parts: Technic, Axle 370826	PG
+	 *	2	32209	Dark Bluish Gray Technic, Axle 5.5 with Stop Catalog: Parts: Technic, Axle 4263624 or 4508553	PG
+	 *	2	32013	Blue Technic, Axle and Pin Connector Angled #1 Catalog: Parts: Technic, Connector 4107797	PG
+	 *	2	32034	Light Bluish Gray Technic, Axle and Pin Connector Angled #2 - 180 degrees Catalog: Parts: Technic, Connector 4211567	PG
+	 *	2	32014	Blue Technic, Axle and Pin Connector Angled #6 - 90 degrees Catalog: Parts: Technic, Connector 4112205	PG
+	 *	1	32184	Light Bluish Gray Technic, Axle and Pin Connector Perpendicular 3L with Center Pin Hole Catalog: Parts: Technic, Connector 6276969 or 4211621	PG
+	 *	2	x1192px1	Black Technic, Axle Connector 2 x 3 with Ball Socket and Axle Socket with Light Bluish Gray Rubber Insert Catalog: Parts: Technic, Connector 4235786	PG
+	 *	10	6538b	Trans-Red Technic, Axle Connector 2L (Ridged with x Hole x Orientation) Catalog: Parts: Technic, Connector 4163625	PG
+	 *	25	43093	Blue Technic, Axle Pin with Friction Ridges Lengthwise Catalog: Parts: Technic, Axle 4309323 or 4206482	PG
+	 *	18	6541	Black Technic, Brick 1 x 1 with Hole Catalog: Parts: Technic, Brick 654126	PG
+	 *	6	32064b	Dark Bluish Gray Technic, Brick 1 x 2 with Axle Hole - X Opening Catalog: Parts: Technic, Brick 4210935	PG
+	 *	6	3700	Black Technic, Brick 1 x 2 with Hole Catalog: Parts: Technic, Brick 370026	PG

+  12 [3700](#) **Light Bluish Gray Technic, Brick 1 x 2 with Hole**
[Catalog:](#) [Parts:](#) [Technic, Brick](#) [PG](#)
4211440

+  8 [3701](#) **Dark Bluish Gray Technic, Brick 1 x 4 with Holes**
[Catalog:](#) [Parts:](#) [Technic, Brick](#) [PG](#)
4213607

+  1 [3894](#) **Black Technic, Brick 1 x 6 with Holes**
[Catalog:](#) [Parts:](#) [Technic, Brick](#) [PG](#)
389426

+  6 [3894](#) **Light Bluish Gray Technic, Brick 1 x 6 with Holes**
[Catalog:](#) [Parts:](#) [Technic, Brick](#) [PG](#)
4211466

+  4 [3702](#) **Black Technic, Brick 1 x 8 with Holes**
[Catalog:](#) [Parts:](#) [Technic, Brick](#) [PG](#)
370226

+  1 [2730](#) **Black Technic, Brick 1 x 10 with Holes**
[Catalog:](#) [Parts:](#) [Technic, Brick](#) [PG](#)
273026

+  10 [32018](#) **Light Bluish Gray Technic, Brick 1 x 14 with Holes**
[Catalog:](#) [Parts:](#) [Technic, Brick](#) [PG](#)
4211705













+  4 [6589](#) **Light Bluish Gray Technic, Gear 12 Tooth Bevel**
[Catalog:](#) [Parts:](#) [Technic, Gear](#) [PG](#)
4565450 or 6589194 or 4211539

+  10 [32270](#) **Black Technic, Gear 12 Tooth Double Bevel**
[Catalog:](#) [Parts:](#) [Technic, Gear](#) [PG](#)
4177431

+  4 [4019](#) **Light Bluish Gray Technic, Gear 16 Tooth (First Version - 4 Round Holes)**
[Catalog:](#) [Parts:](#) [Technic, Gear](#) [PG](#)
4562487 or 4211563 or 4019194

+  4 [32198](#) **Light Bluish Gray Technic, Gear 20 Tooth Bevel**
[Catalog:](#) [Parts:](#) [Technic, Gear](#) [PG](#)
6031956 or 4211885

+  5 [32269](#) **Light Bluish Gray Technic, Gear 20 Tooth Double Bevel**
[Catalog:](#) [Parts:](#) [Technic, Gear](#) [PG](#)
32269194 or 4211635

+		6	3648	Light Bluish Gray Technic, Gear 24 Tooth (2nd Version - 1 Axle Hole) Catalog: Parts: Technic, Gear 4211565	PG
+		1	32498	Black Technic, Gear 36 Tooth Double Bevel Catalog: Parts: Technic, Gear 4177434 or 4255563	PG
+		2	4716	Light Bluish Gray Technic, Gear Worm Screw, Long Catalog: Parts: Technic, Gear 6185471 or 4211510	PG
+		12	41677	White Technic, Liftarm 1 x 2 Thin Catalog: Parts: Technic, Liftarm 416771 or 4163533	PG
+		2	50923	Dark Bluish Gray Technic, Liftarm 1 x 2 with Ball Joint Angled Catalog: Parts: Technic, Liftarm 4503381 or 4289258	PG
+		10	6632	Light Bluish Gray Technic, Liftarm 1 x 3 Thin Catalog: Parts: Technic, Liftarm 4211566	PG
+		12	4274	Light Bluish Gray Technic, Pin 1/2 Catalog: Parts: Technic, Pin 4211483 or 4274194	PG
+		2	6558	Black Technic, Pin 3L with Friction Ridges Lengthwise Catalog: Parts: Technic, Pin 655826	PG
+		1	32530	Dark Bluish Gray Technic, Pin Connector Plate 1 x 2 x 1 2/3 with 2 Holes (Double on Top) Catalog: Parts: Technic, Connector 4210763	PG
+		28	2780	Black Technic, Pin with Friction Ridges Lengthwise WITH Center Slots Catalog: Parts: Technic, Pin 4121715 or 278026	PG
+		4	3673	Light Bluish Gray Technic, Pin without Friction Ridges Lengthwise Catalog: Parts: Technic, Pin 3673194 or 4211807	PG
+		1	2819	Light Bluish Gray Technic, Steering Wheel Small, 3 Studs Diameter Catalog: Parts: Technic, Steering 4580510 or 4211578	PG

+	 *	1	9244c01 (inv)	Light Bluish Gray Technic, Universal Joint 4L <small>Catalog: Parts: Technic Connector 4240416 or 9244194</small>	PG
---	---	---	-------------------------------	---	--------------------

+	 *	9	3070b	Dark Bluish Gray Tile 1 x 1 with Groove (3070) <small>Catalog: Parts: Tile 4210848</small>	PG
---	--	---	-----------------------	--	--------------------

+	 *	2	3069b	Black Tile 1 x 2 with Groove <small>Catalog: Parts: Tile 306926</small>	PG
---	--	---	-----------------------	---	--------------------

+	 *	8	2555	Light Bluish Gray Tile, Modified 1 x 1 with Clip <small>Catalog: Parts: Tile Modified 6030711 or 2555194 or 4211369</small>	PG
---	--	---	----------------------	---	--------------------

+	 *	6	2412b	Dark Bluish Gray Tile, Modified 1 x 2 Grille with Bottom Groove / Lip <small>Catalog: Parts: Tile Modified 4210631</small>	PG
---	--	---	-----------------------	--	--------------------

+	 *	1	6180	Black Tile, Modified 4 x 6 with Studs on Edges <small>Catalog: Parts: Tile Modified 4100378</small>	PG
---	---	---	----------------------	---	--------------------

+	 *	4	41897	Black Tire 56 x 28 ZR Street <small>Catalog: Parts: Tire & Tread 4192763 or 6035364 or 4283701</small>	PG
---	--	---	-----------------------	--	--------------------







+	 *	2	30663	Black Vehicle, Steering Wheel Small, 2 Studs Diameter <small>Catalog: Parts: Vehicle 6057397 or 4153044</small>	PG
---	--	---	-----------------------	---	--------------------

+	 *	8	6126	Trans-Neon Orange Wave Rounded with Base Pins (Castle Dragon Flame, Seaweed, Water) <small>Catalog: Parts: Energy Effect 612647</small>	PG
---	--	---	----------------------	---	--------------------

+	 *	2	6565	Black Wedge 3 x 2 Left <small>Catalog: Parts: Wedge 4527766 or 656526</small>	PG
---	--	---	----------------------	---	--------------------

+	 *	2	6564	Black Wedge 3 x 2 Right <small>Catalog: Parts: Wedge 4526931 or 656426</small>	PG
---	--	---	----------------------	--	--------------------

+	 *	8	30505	Black Wedge 3 x 3 Cut Corner <small>Catalog: Parts: Wedge 4159550</small>	PG
---	--	---	-----------------------	---	--------------------

+	 *	9	41768	Black Wedge 4 x 2 Left Catalog: Parts: Wedge 6078889 or 4644755 or 4160349	PG
+	 *	9	41767	Black Wedge 4 x 2 Right Catalog: Parts: Wedge 6078886 or 4644754 or 4160334	PG
+	 *	5	43721	Black Wedge 4 x 2 Sloped Left Catalog: Parts: Wedge 4570401 or 4180518	PG
+	 *	5	43720	Black Wedge 4 x 2 Sloped Right Catalog: Parts: Wedge 4570397 or 4180526	PG
+	 *	1	43710	Black Wedge 4 x 2 Triple Left Catalog: Parts: Wedge 6040297 or 4180413	PG
+	 *	1	43711	Black Wedge 4 x 2 Triple Right Catalog: Parts: Wedge 6040298 or 4180423	PG
+	 *	1	47753	Black Wedge 4 x 4 No Top Studs Catalog: Parts: Wedge 4219107	PG
+	 *	5	41748	Black Wedge 6 x 2 Left Catalog: Parts: Wedge 4160130	PG
+	 *	5	41747	Black Wedge 6 x 2 Right Catalog: Parts: Wedge 4160108	PG
+	 *	1	41750	Black Wedge 8 x 3 x 2 Open Left Catalog: Parts: Wedge 6271277 or 6185621 or 4160738 or 4195702 or 4205271 or 4286971	PG
+	 *	1	41749	Black Wedge 8 x 3 x 2 Open Right Catalog: Parts: Wedge 6271278 or 6185619 or 4195701 or 4205272 or 4286970	PG
+	 *	1	45301	Black Wedge 16 x 4 Triple Curved Catalog: Parts: Wedge 4200486	PG

+	 *	1	43723	Black Wedge, Plate 3 x 2 Left Catalog: Parts: Wedge, Plate 4180536	PG
---	---	---	-----------------------	---	--------------------

+	 *	1	43722	Black Wedge, Plate 3 x 2 Right Catalog: Parts: Wedge, Plate 4180508	PG
---	--	---	-----------------------	--	--------------------

+	 *	1	54384	Black Wedge, Plate 6 x 3 Left Catalog: Parts: Wedge, Plate 4283047	PG
---	--	---	-----------------------	---	--------------------

+	 *	1	54383	Black Wedge, Plate 6 x 3 Right Catalog: Parts: Wedge, Plate 4283046	PG
---	--	---	-----------------------	--	--------------------

+	 *	3	50305	Black Wedge, Plate 8 x 3 Left Catalog: Parts: Wedge, Plate 4251394	PG
---	--	---	-----------------------	---	--------------------

+	 *	3	50304	Black Wedge, Plate 8 x 3 Right Catalog: Parts: Wedge, Plate 4251393	PG
---	---	---	-----------------------	--	--------------------

+	 *	1	2621	Black Wedge, Plate 9 x 10 (Boat Bow Plate) Catalog: Parts: Wedge, Plate 4299386	PG
---	--	---	----------------------	--	--------------------

+	 *	1	47397	Light Bluish Gray Wedge, Plate 12 x 3 Left Catalog: Parts: Wedge, Plate 4208988	PG
---	--	---	-----------------------	--	--------------------

+	 *	1	47398	Light Bluish Gray Wedge, Plate 12 x 3 Right Catalog: Parts: Wedge, Plate 4209006	PG
---	--	---	-----------------------	---	--------------------

+	 *	8	56145	Black Wheel 30.4mm D. x 20mm with No Pin Holes and Reinforced Rim Catalog: Parts: Wheel 4299389	PG
---	--	---	-----------------------	--	--------------------

+	 *	4	41896	Pearl Gold Wheel 43.2mm D. x 26mm Technic Racing Small, 3 Pin Holes Catalog: Parts: Wheel 4297499	PG
---	--	---	-----------------------	--	--------------------

Extra Items:

+		1	4073	Trans-Red Plate, Round 1 x 1 Catalog: Parts: Plate, Round 6208450 or 3005741	PG
---	---	---	----------------------	---	--------------------



*

+



*

1

[3713](#)**Red Technic Bush**Catalog: [Parts: Technic](#)
6271820 or 4227155[PG](#)

+



*

1

[4265c](#)**Yellow Technic Bush 1/2 Smooth**Catalog: [Parts: Technic](#)
6271167 or 4239601 or 3212324[PG](#)

+



*

1

[4274](#)**Light Bluish Gray Technic, Pin 1/2**Catalog: [Parts: Technic, Pin](#)
4211483 or 4274194[PG](#)

+



*

1

[2780](#)**Black Technic, Pin with Friction Ridges Lengthwise WITH Center Slots**Catalog: [Parts: Technic, Pin](#)
4121715 or 278026[PG](#)

+



*

1

[3673](#)**Light Bluish Gray Technic, Pin without Friction Ridges Lengthwise**Catalog: [Parts: Technic, Pin](#)
3673194 or 4211807[PG](#)

+

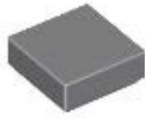

*

1

[3070b](#)**Dark Bluish Gray Tile 1 x 1 with Groove (3070)**Catalog: [Parts: Tile](#)
4210848[PG](#)**Counterparts:**

+



*

2

[43121c02\(inv\)](#)**Light Bluish Gray Engine, Large, with Black Center (43121 / x577)**Catalog: [Parts: Aircraft](#)
Part Color Code Missing[PG](#)

+



*

4

[41896c04\(inv\)](#)**Pearl Gold Wheel 43.2mm D. x 26mm Technic Racing Small, 3 Pin Holes with Black Tire 56 x 28 ZR Street (41896 / 41897)**Catalog: [Parts: Wheel & Tire Assembly](#)
Part Color Code Missing[PG](#)**Alternate Items:**

+



*

6

[3037b](#)**Black Slope 45 2 x 4 Smooth**Catalog: [Parts: Slope](#)
Part Color Code Missing[PG](#)

1



+



*

6

[32064](#)**Dark Bluish Gray Technic, Brick 1 x 2 with Axle Hole**Catalog: [Parts: Technic, Brick](#)
6178919 or 4210935[PG](#)

2

**Summary:**

Type	Unique Lots	Total Qty
Regular Items:		
Parts	166	1045
Extra Items:		
Parts	7	7
Counterparts:		
Parts	2	6
Alternative Items:		
Parts	2	12

[tEoS \(4971\)](#)  inventoried this Set on Jun 12, 2006, inventory last updated on Nov 7, 2018.