

**LEGO** SYSTEM™

**MODEL** 5563  
**TEAM**

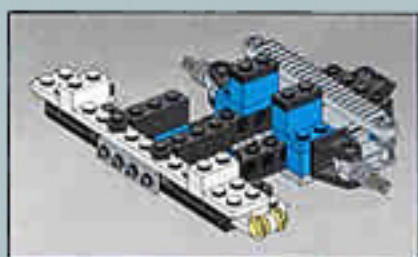

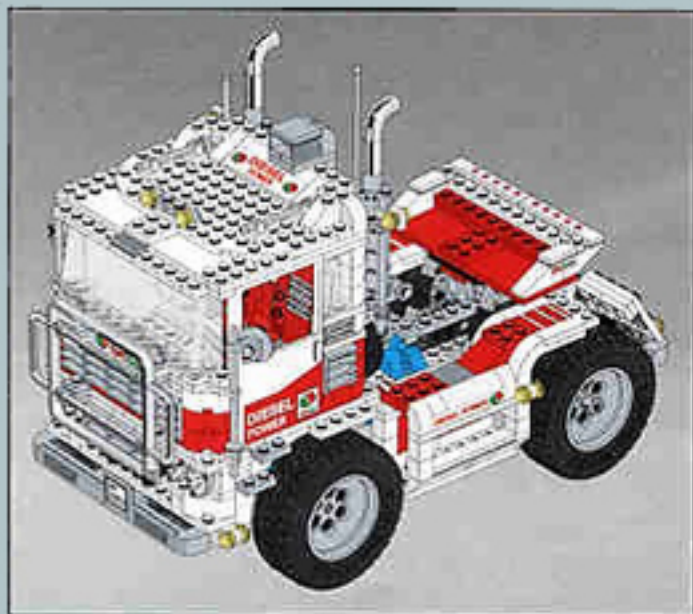
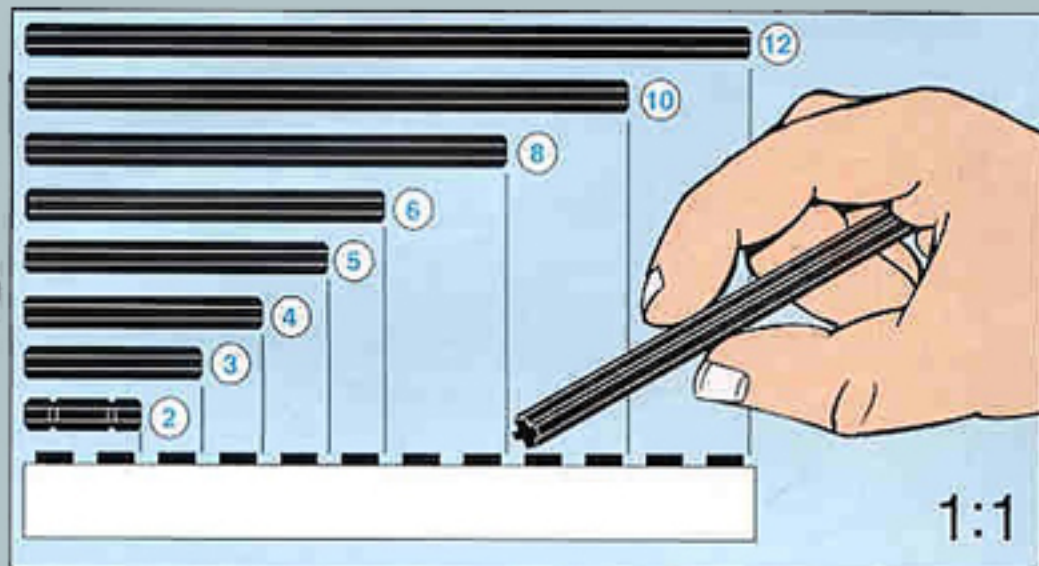

1

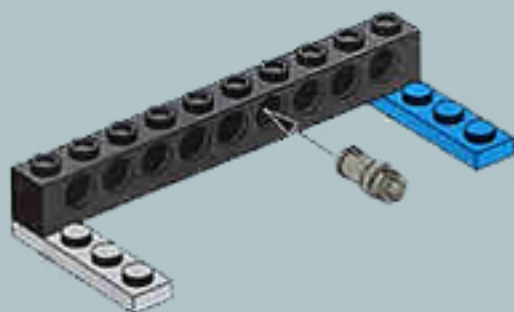



2

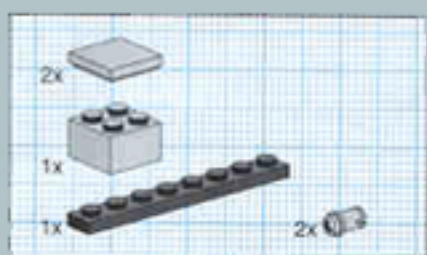
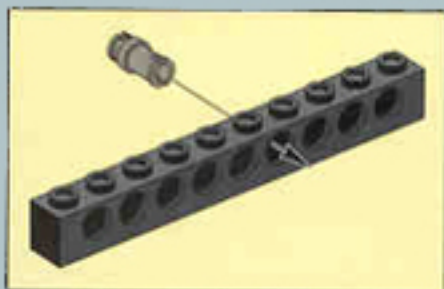

3

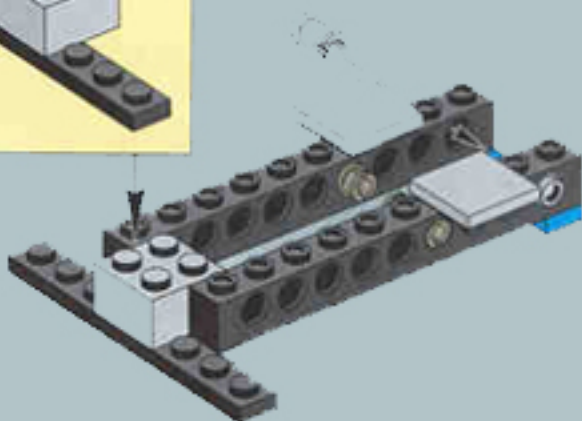
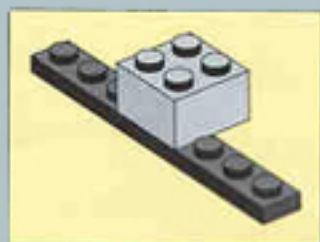

4

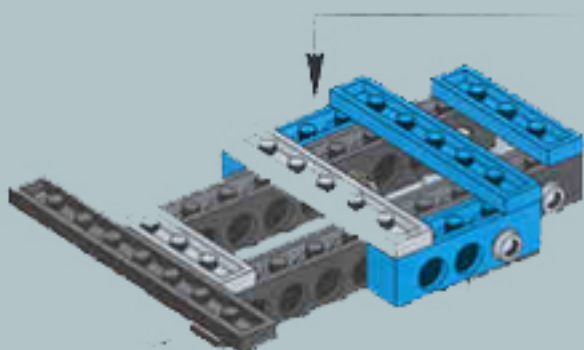
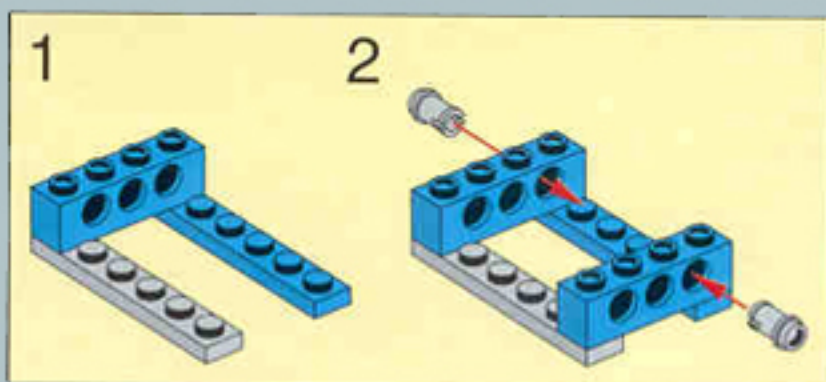



5

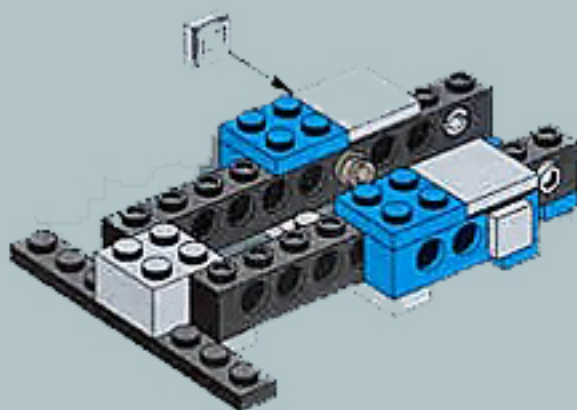

6

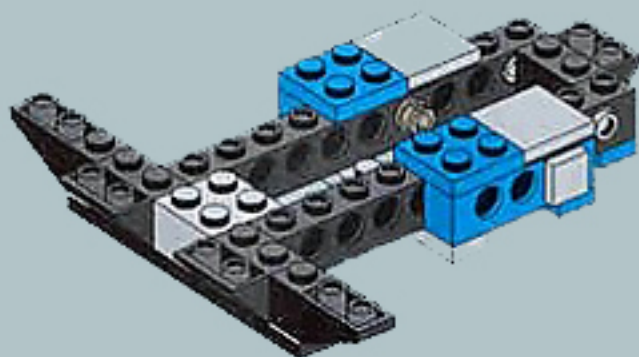

7

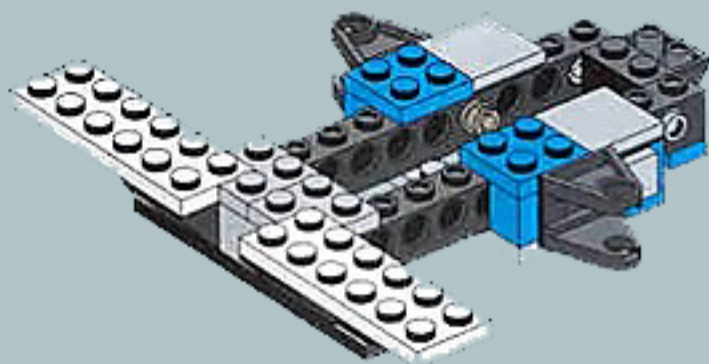

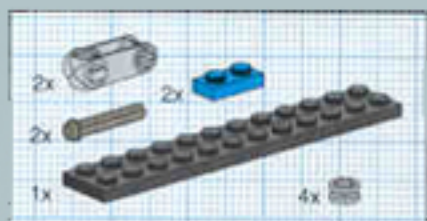

8

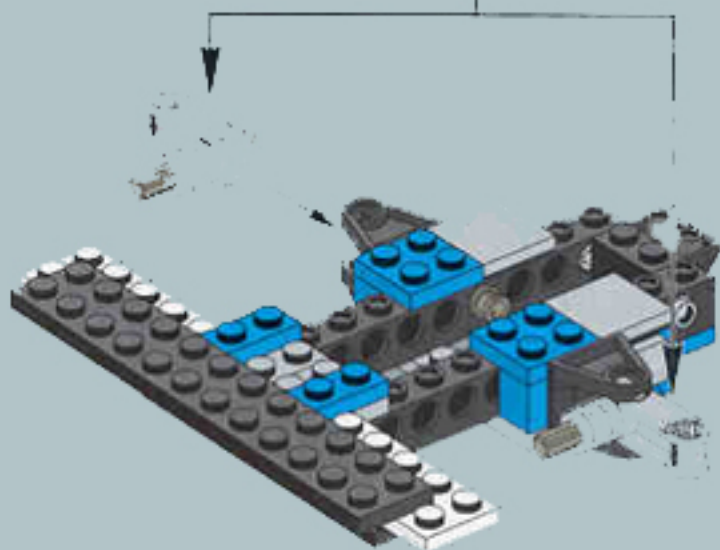
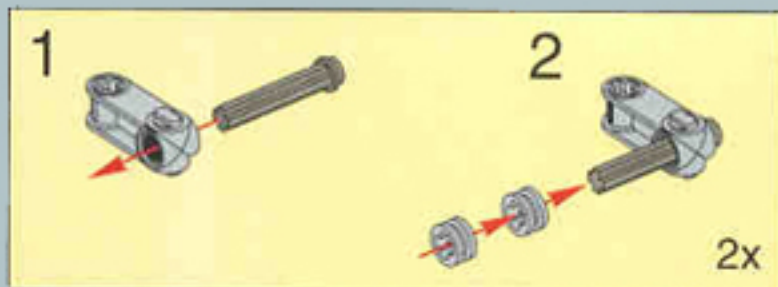

9

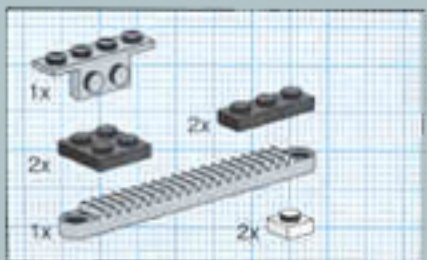
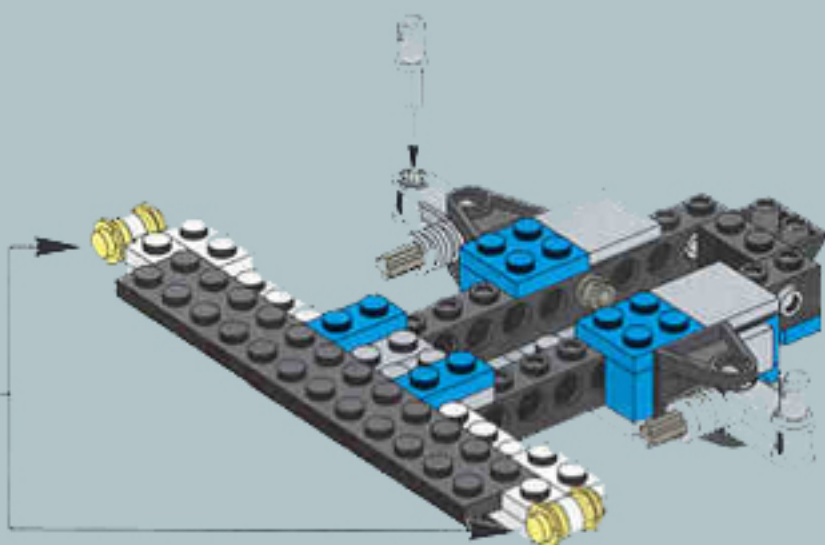
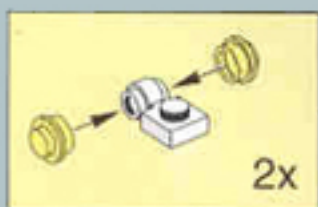

10

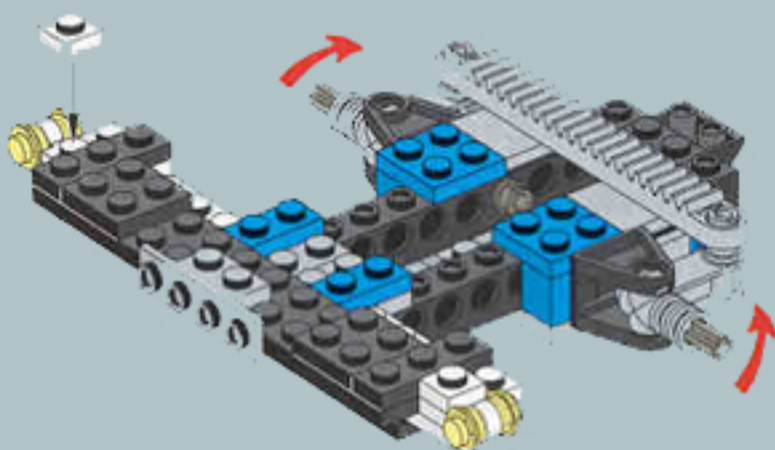

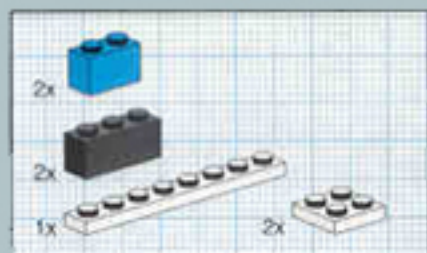

# 11

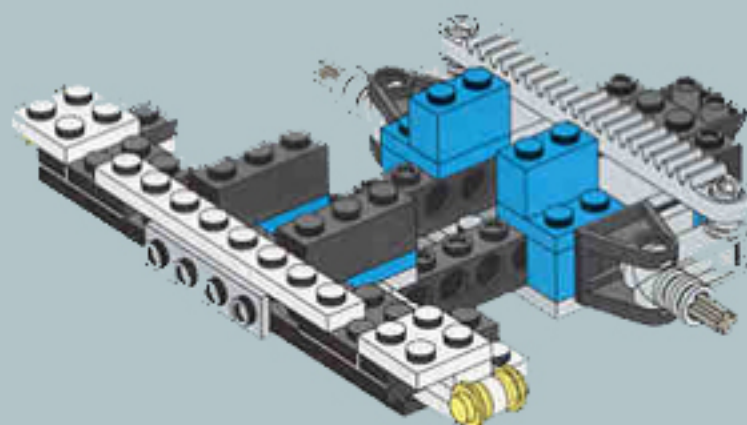

# 12

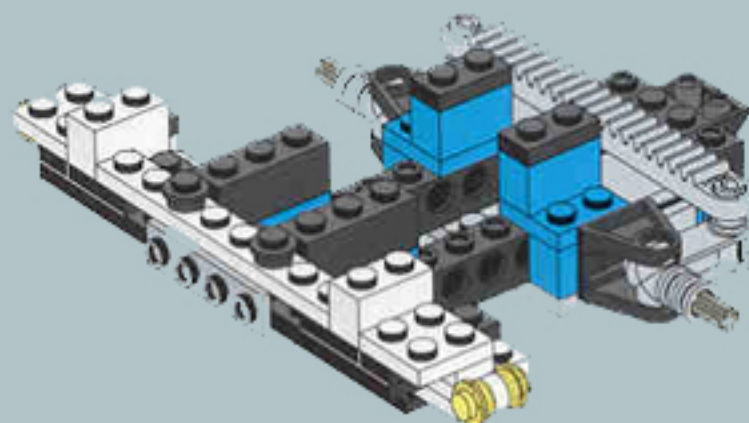

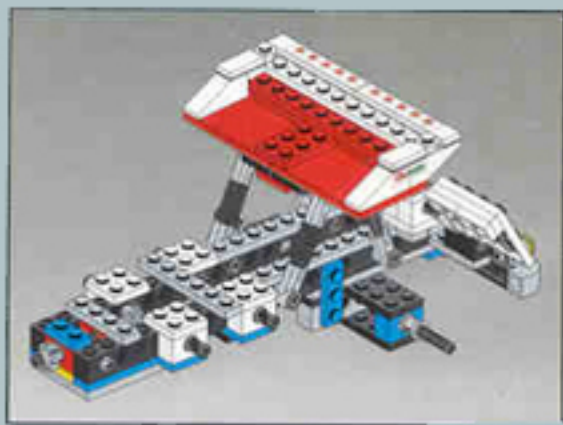

1

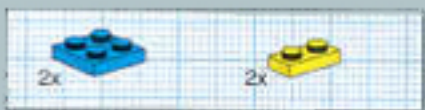
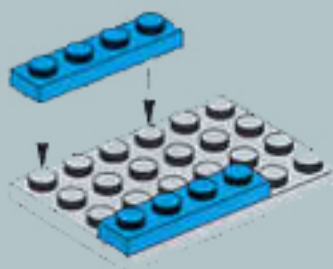

2

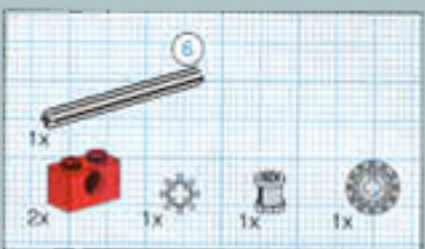
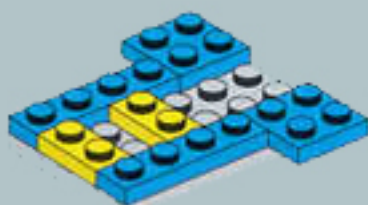

3

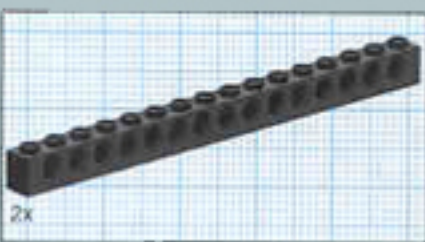
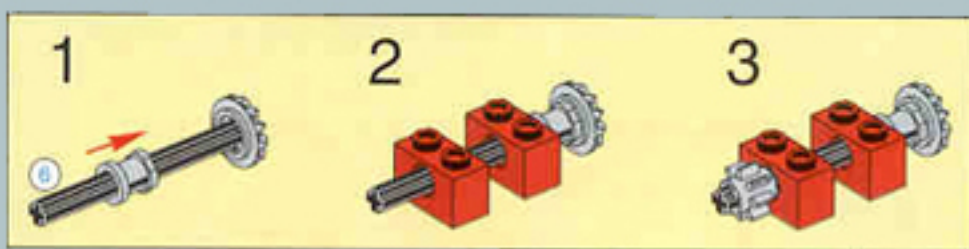

4

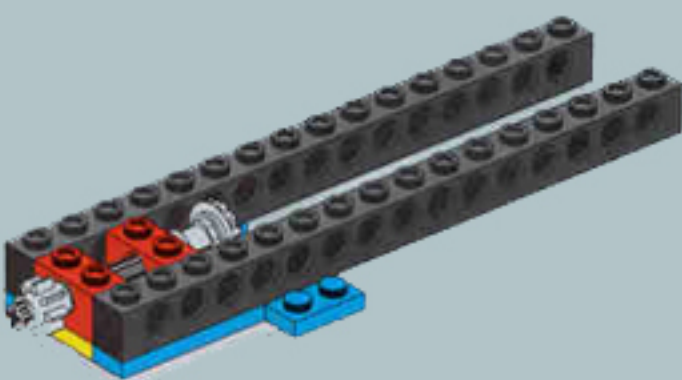

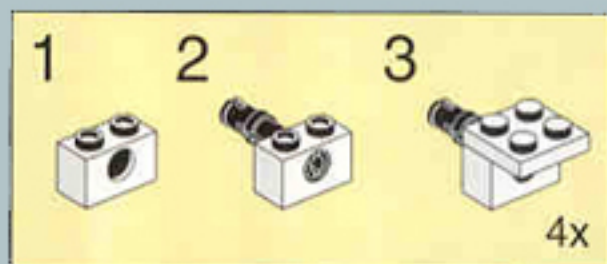

5

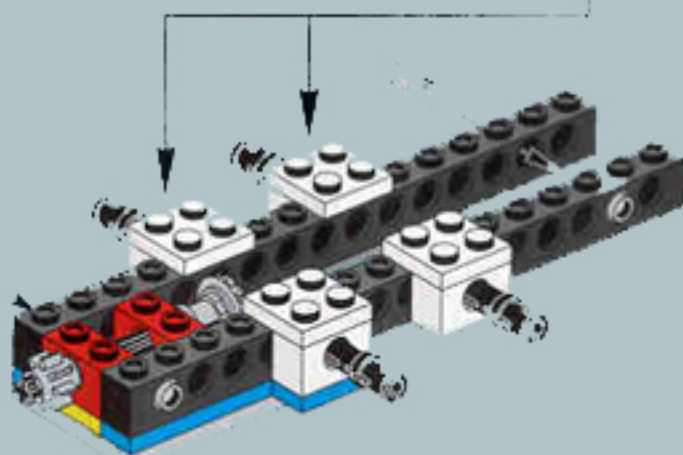

6

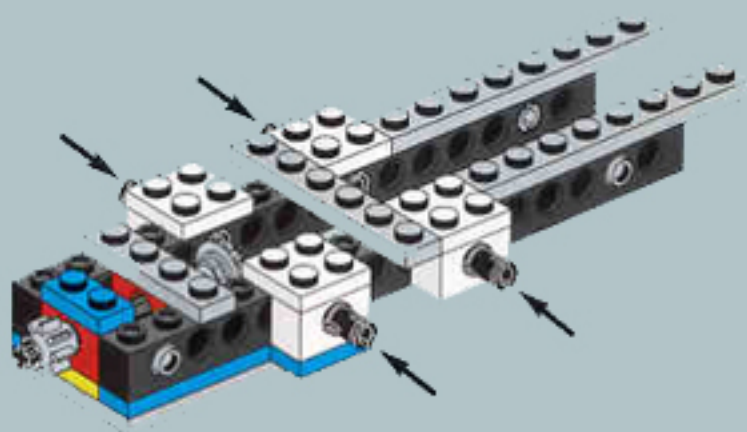

7

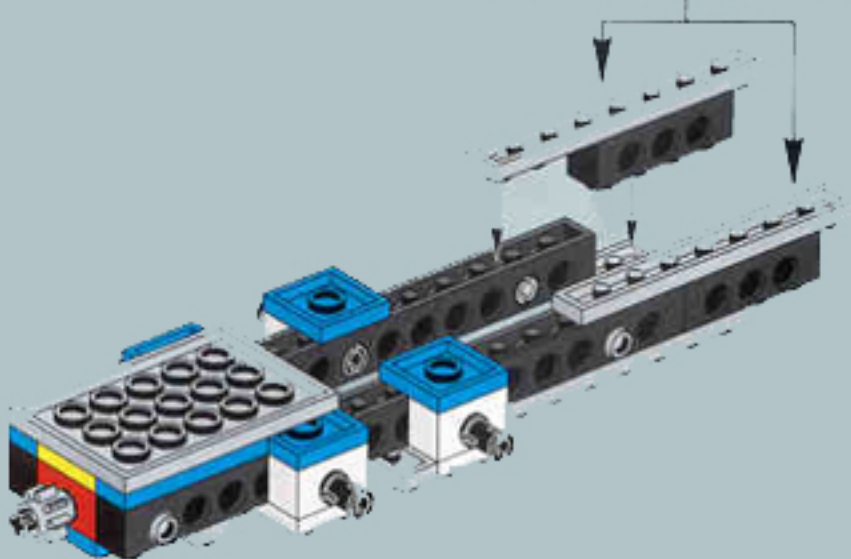
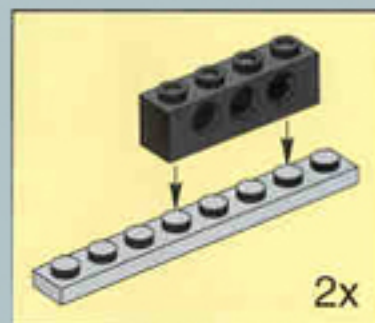



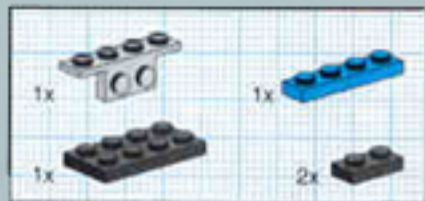

8

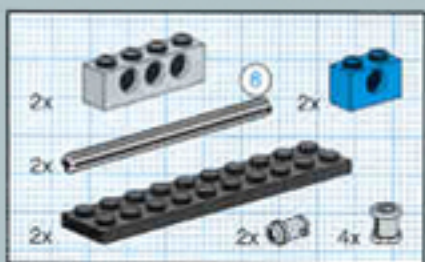
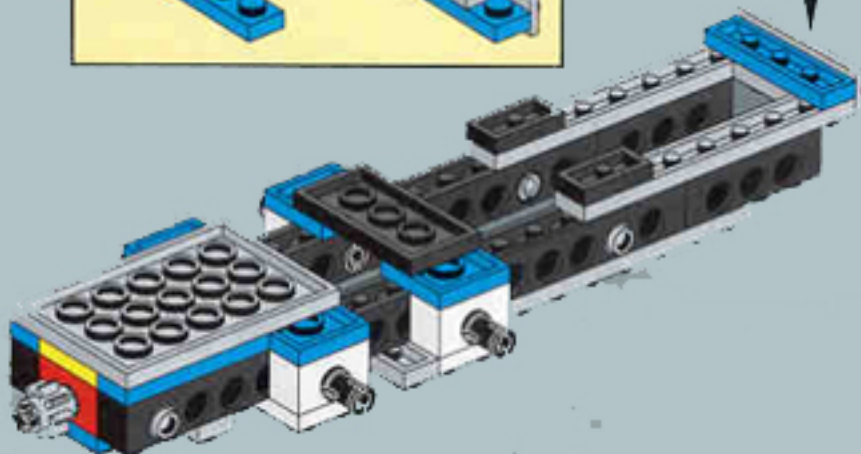
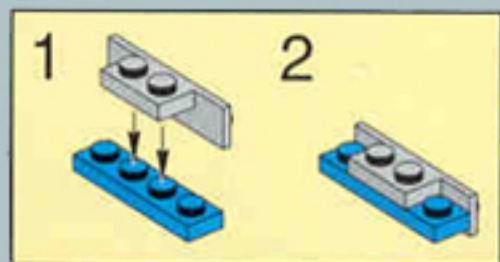

9

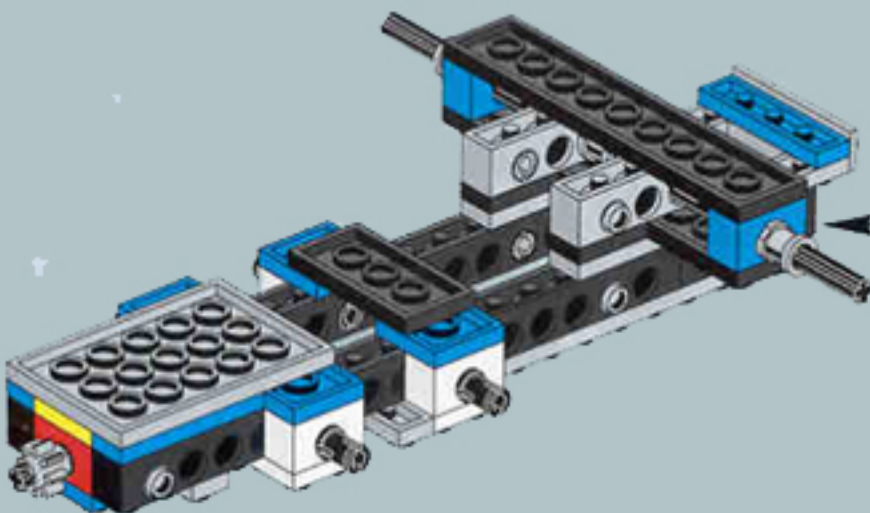
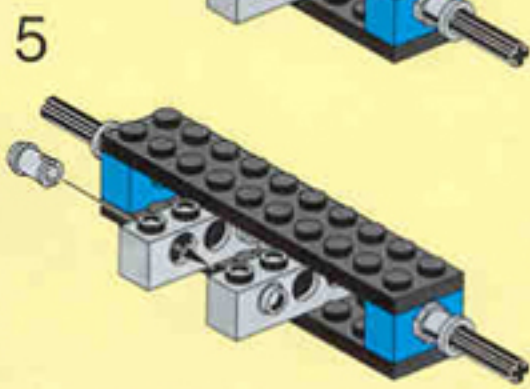
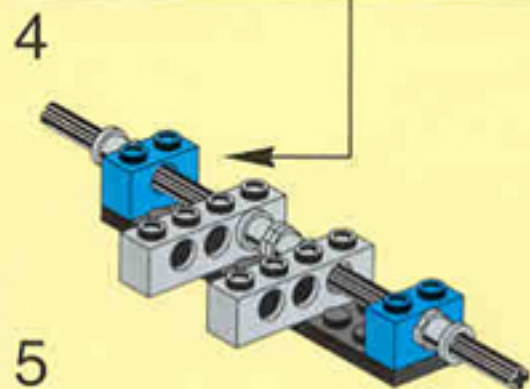
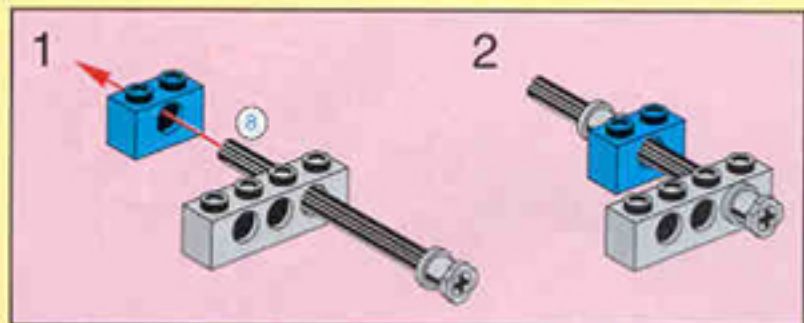
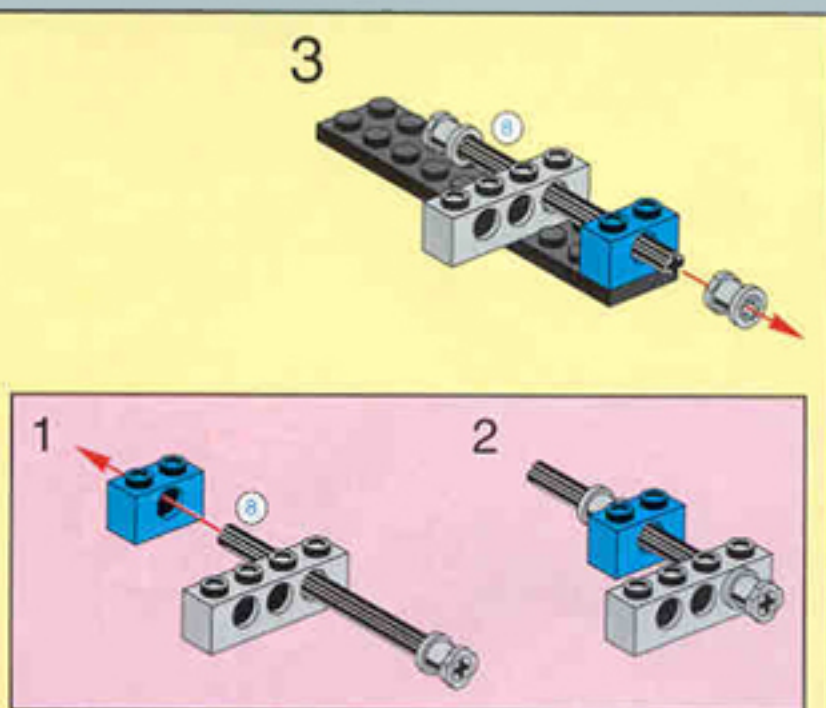
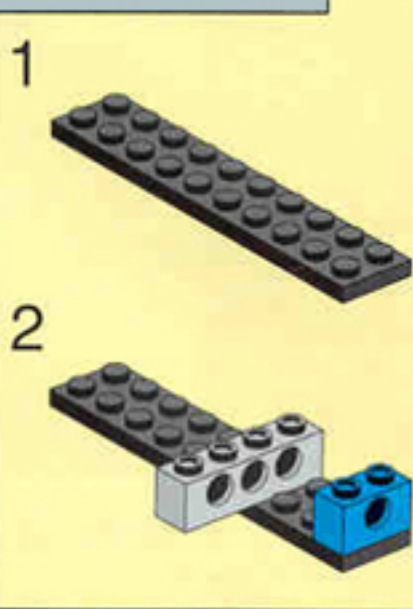



10

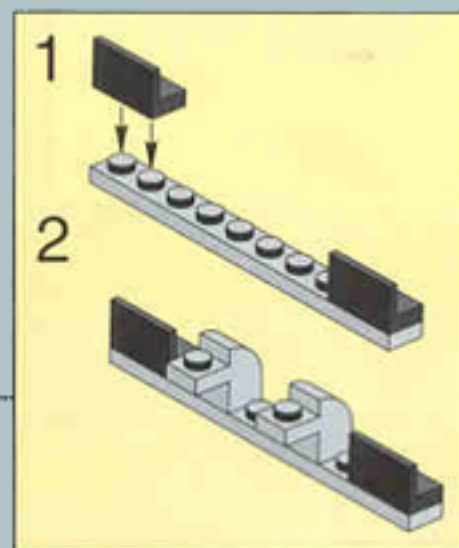
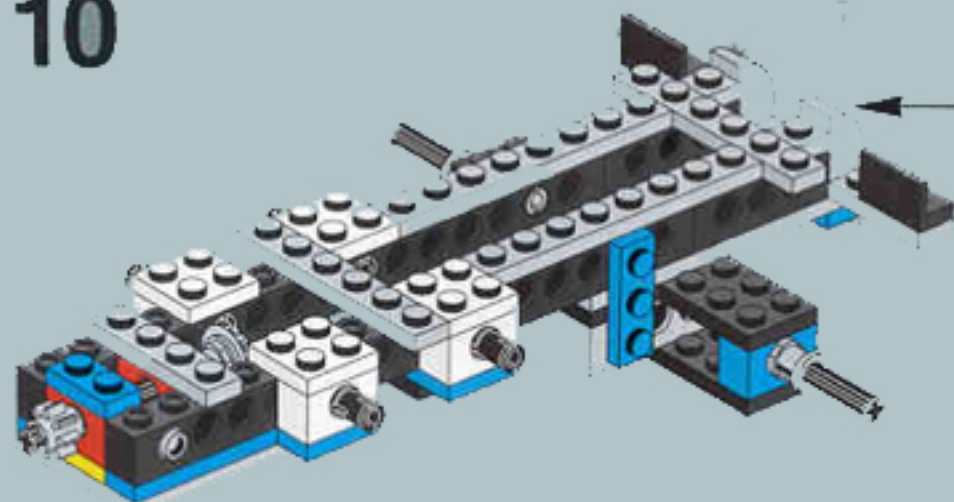

11

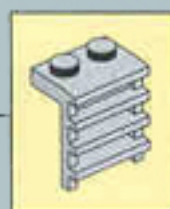
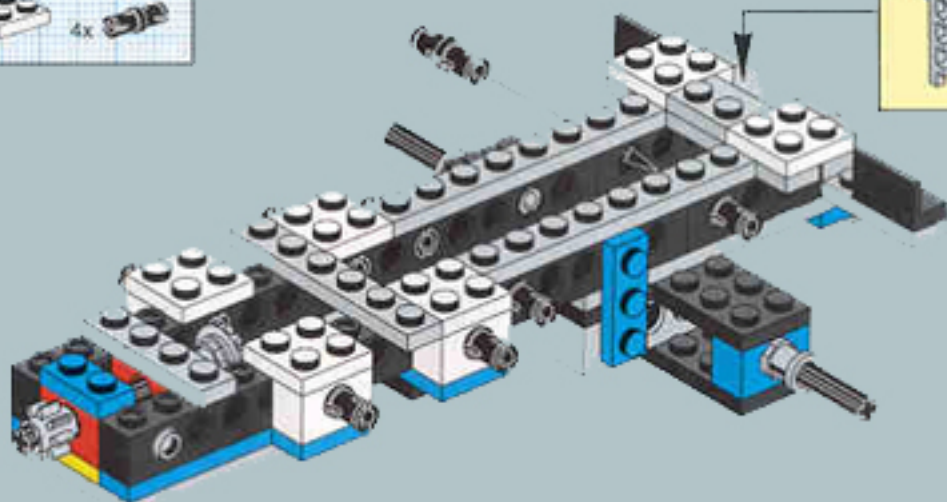

12

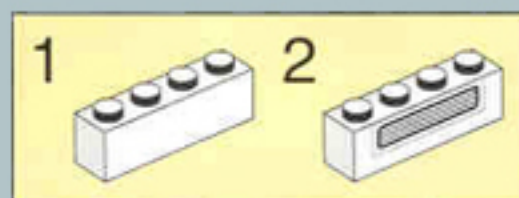
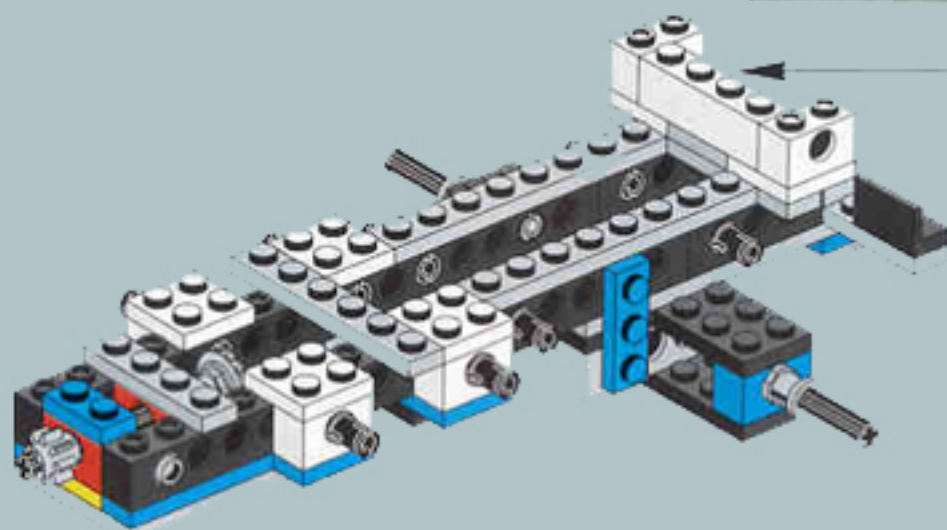

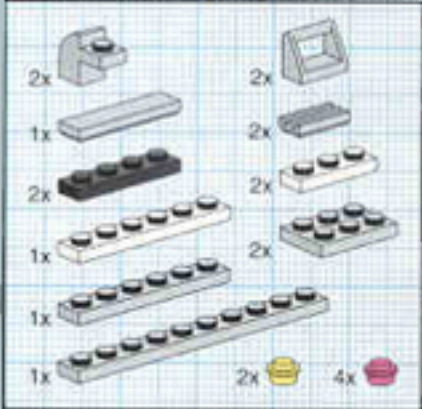

# 13

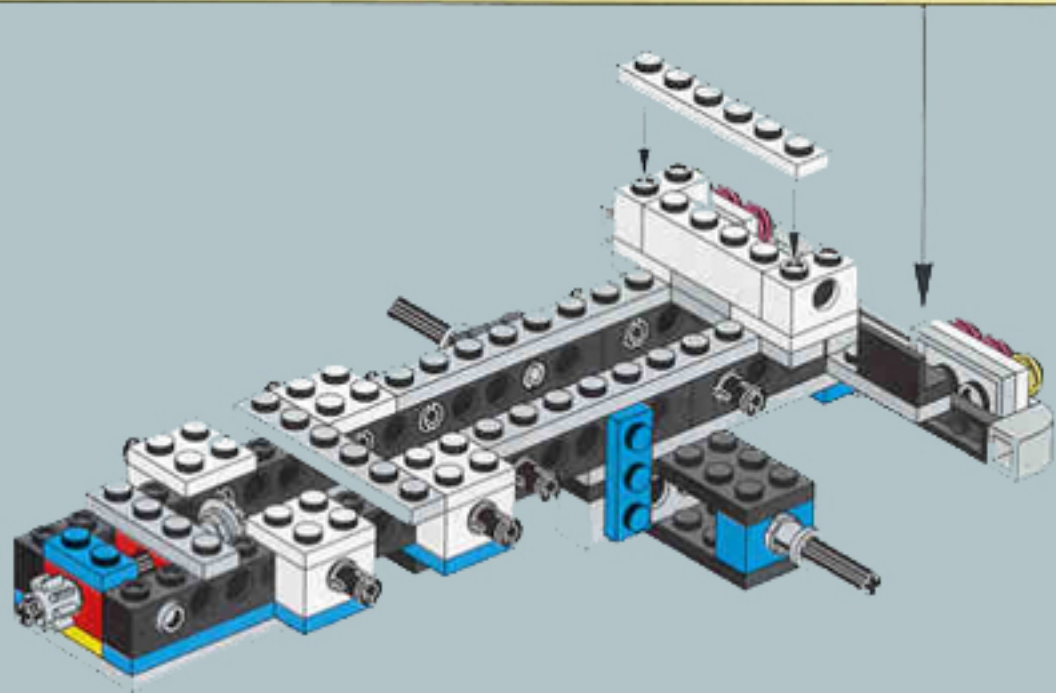
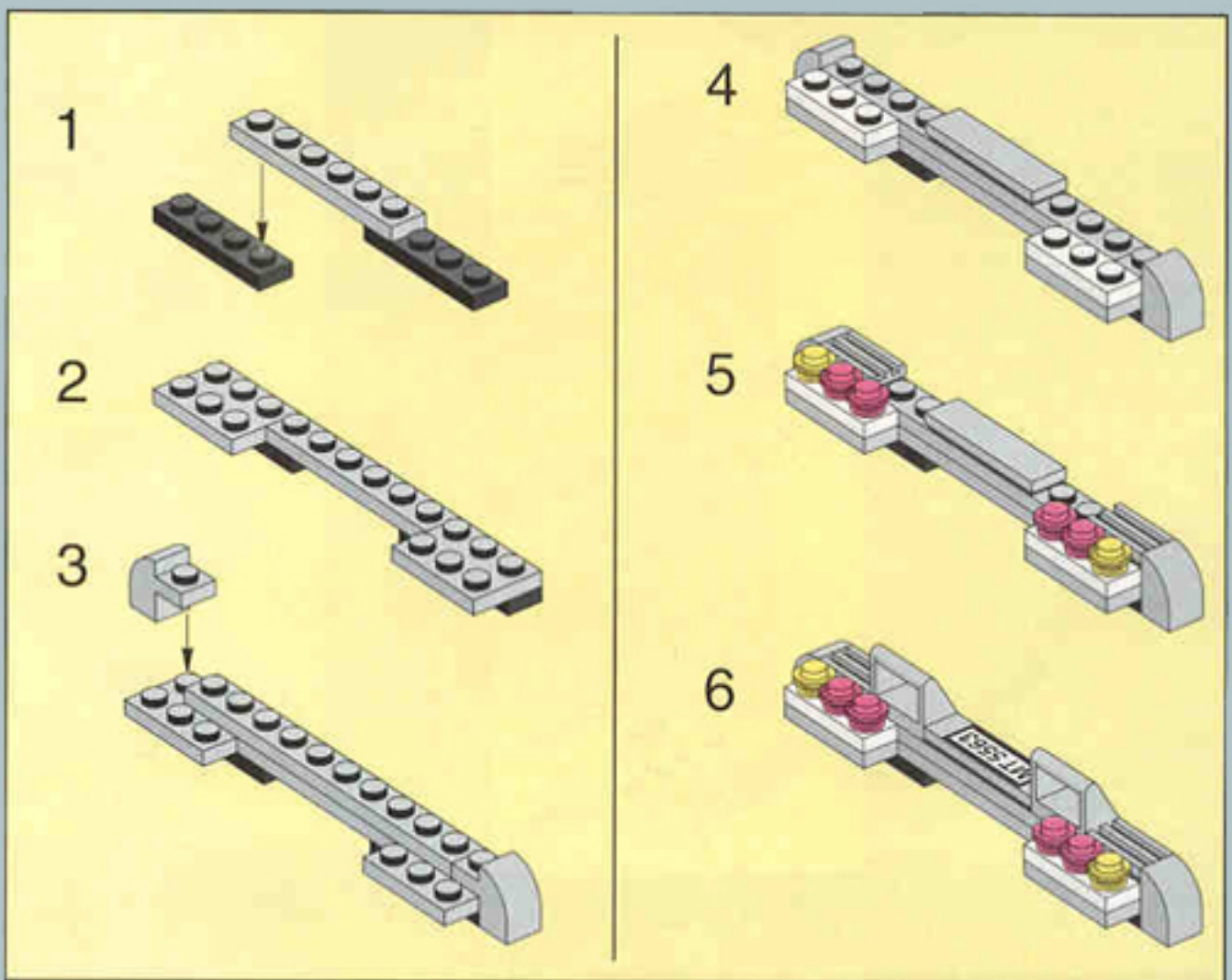

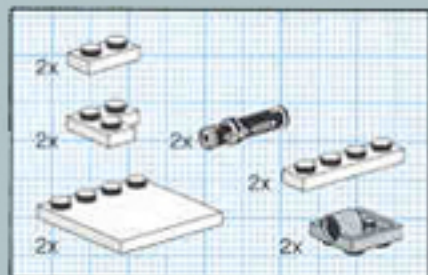

14

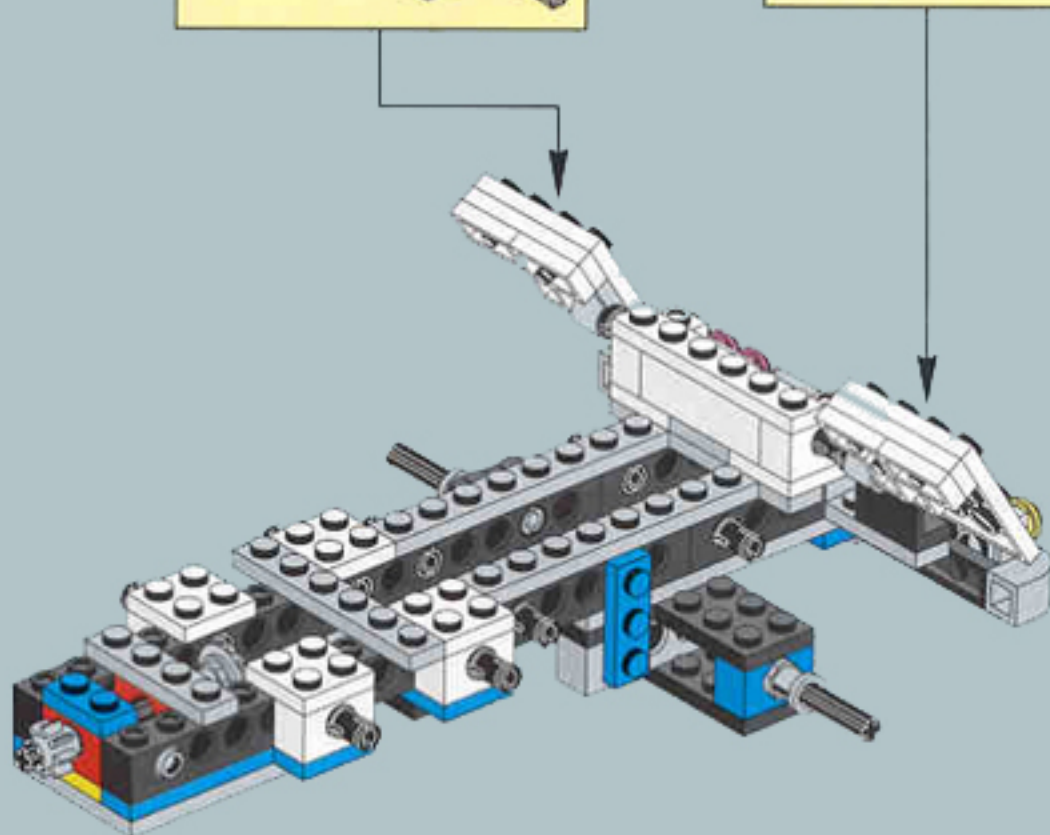
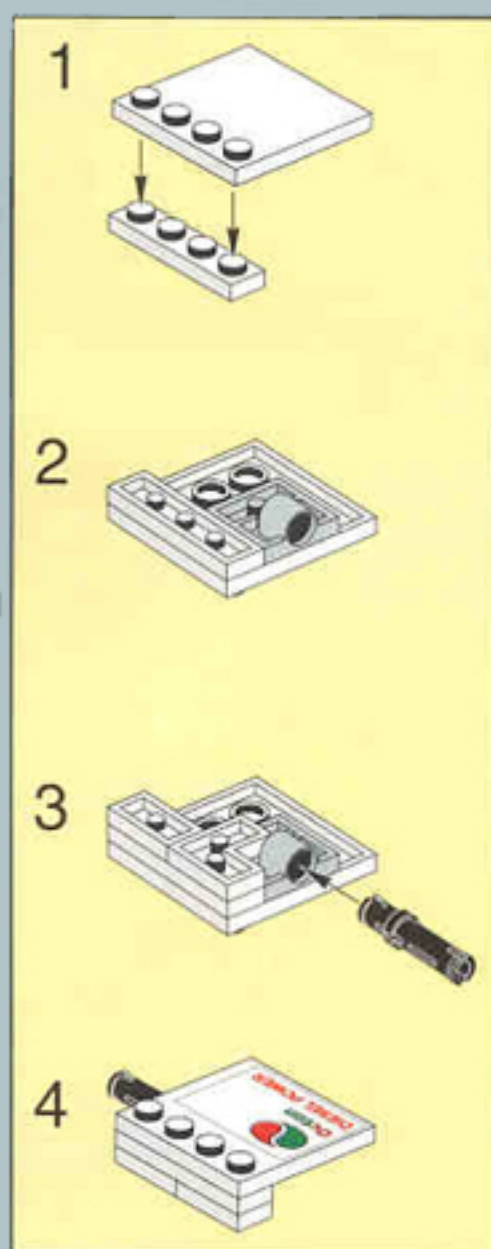
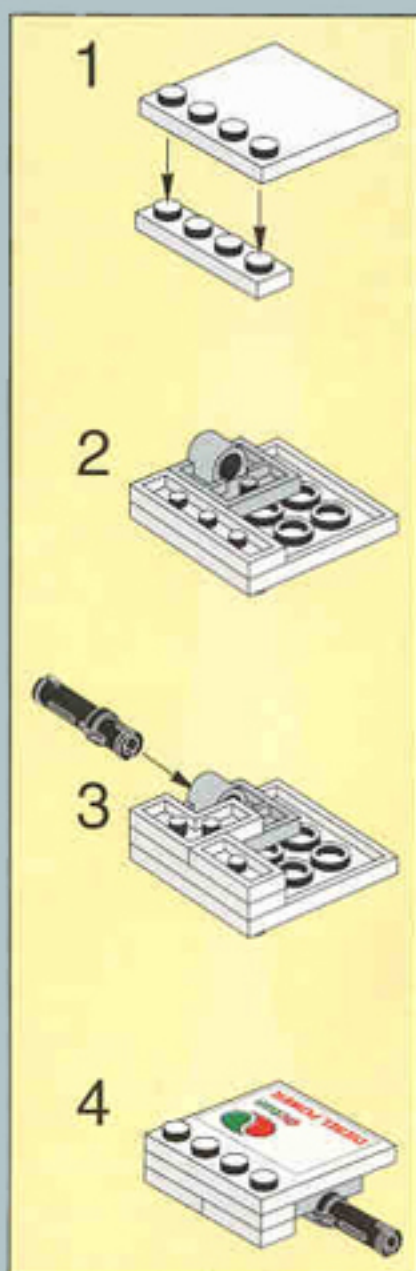



# 15

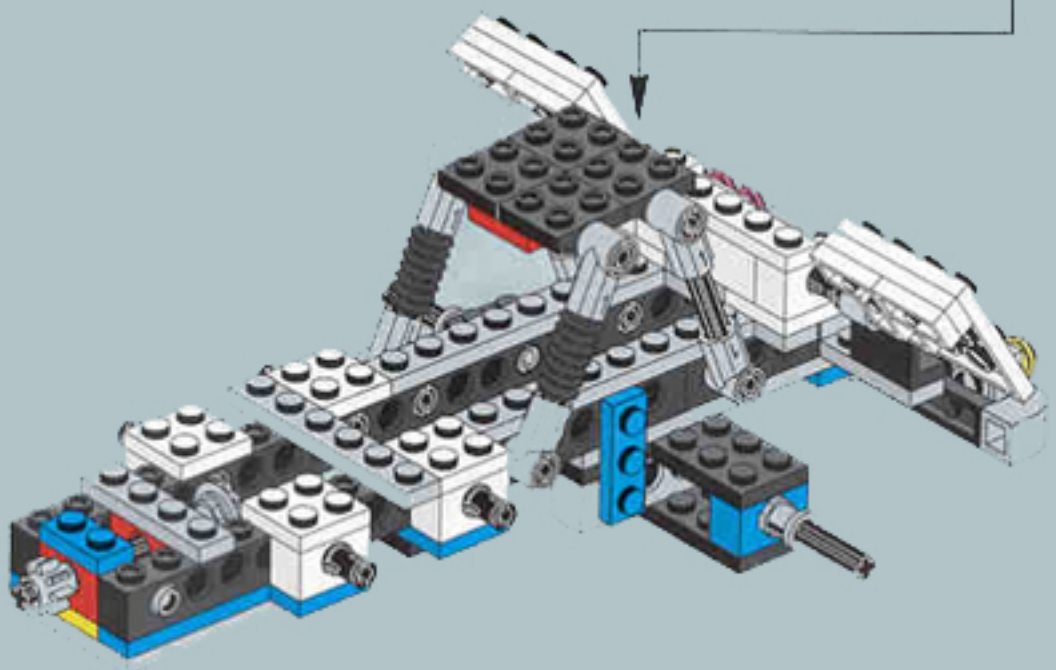
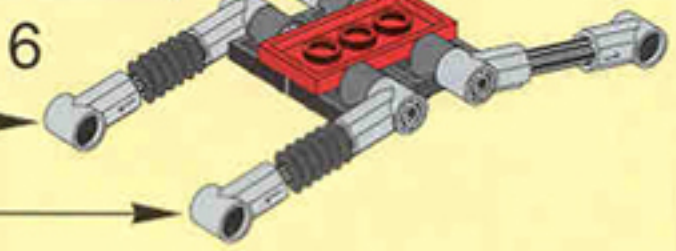
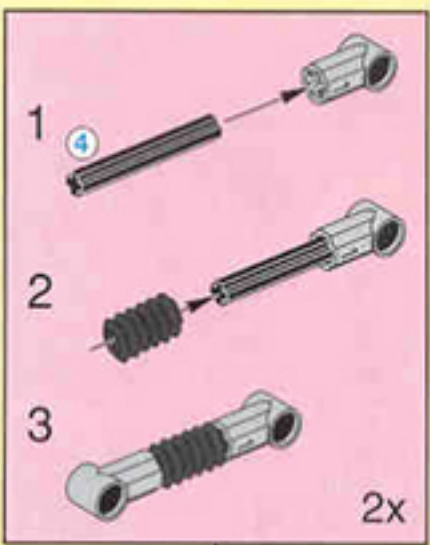
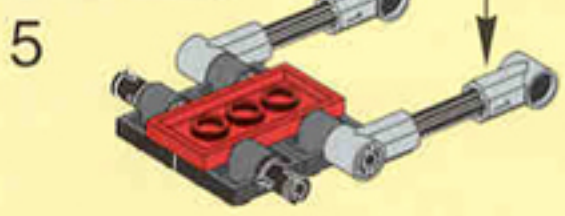
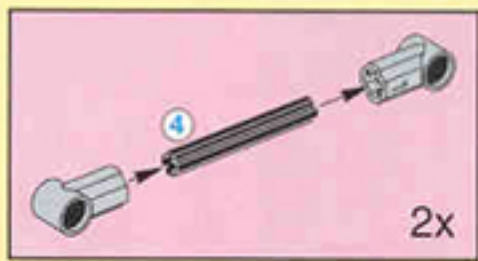
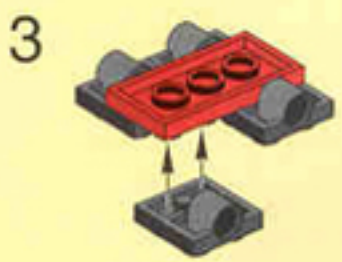

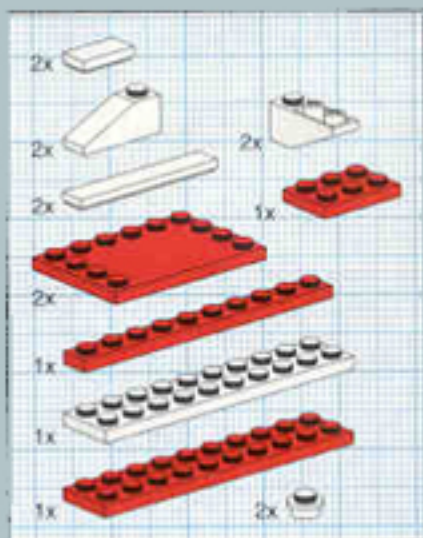

# 16

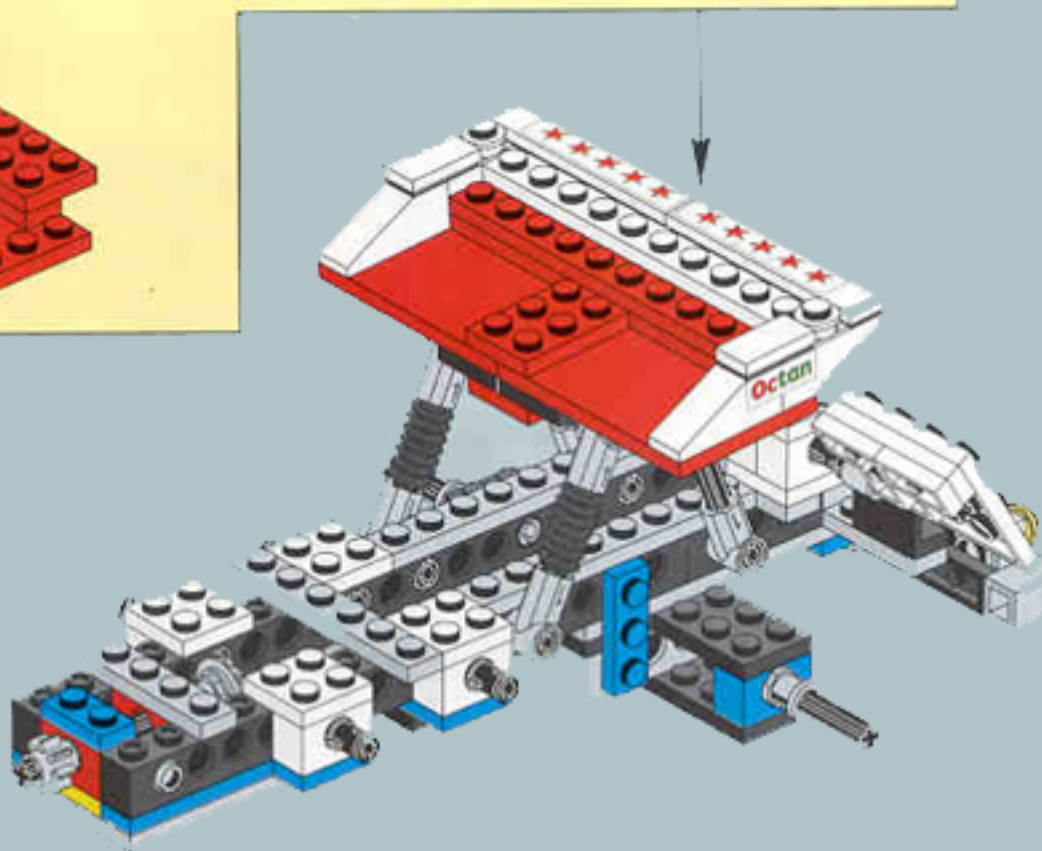
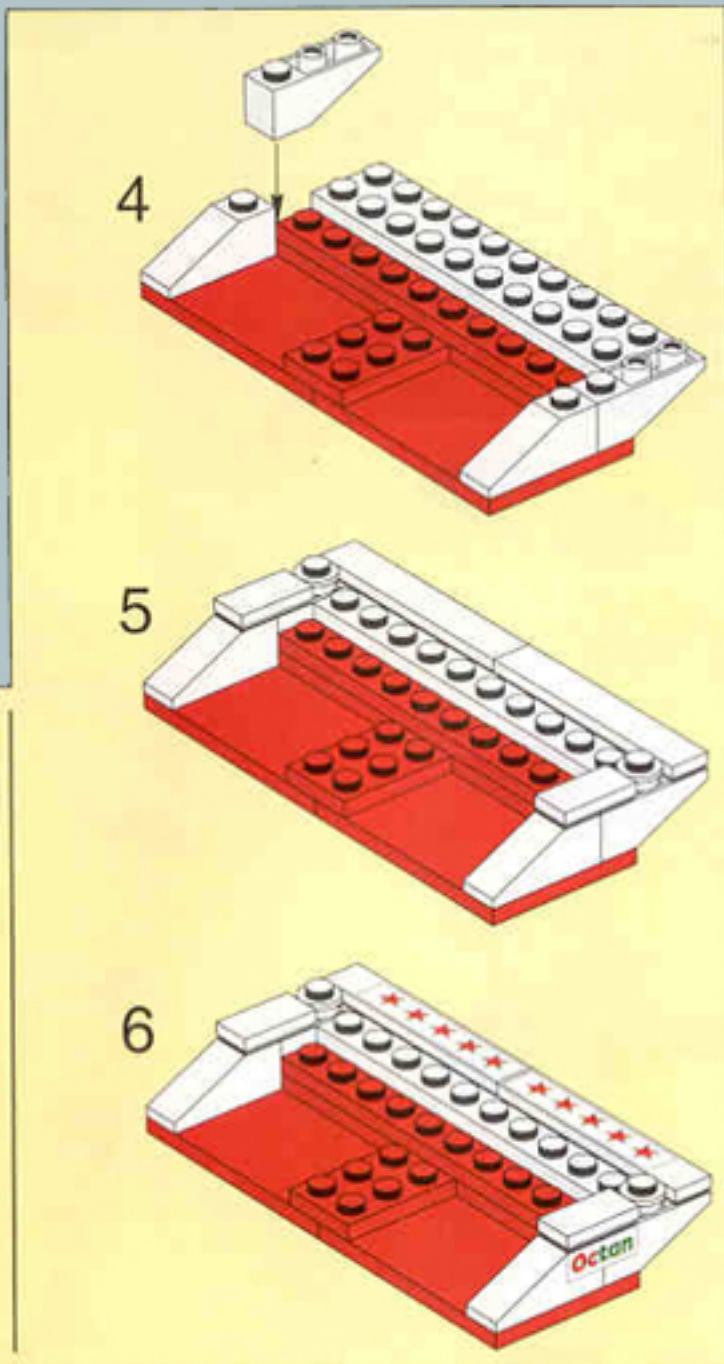
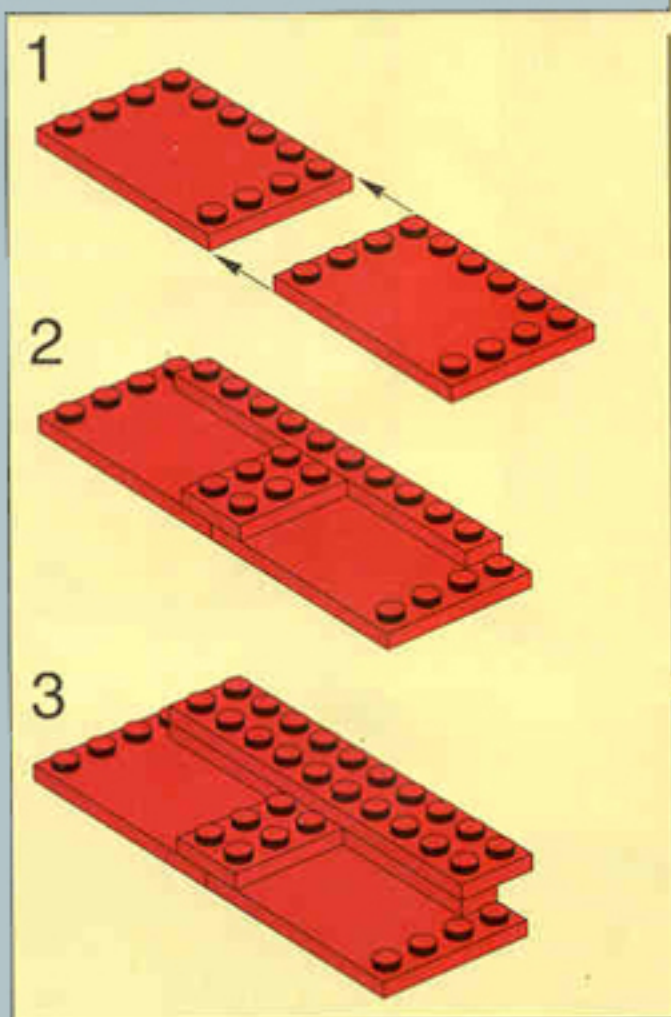

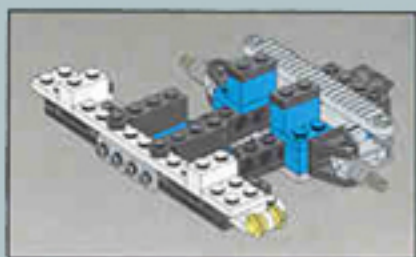

+

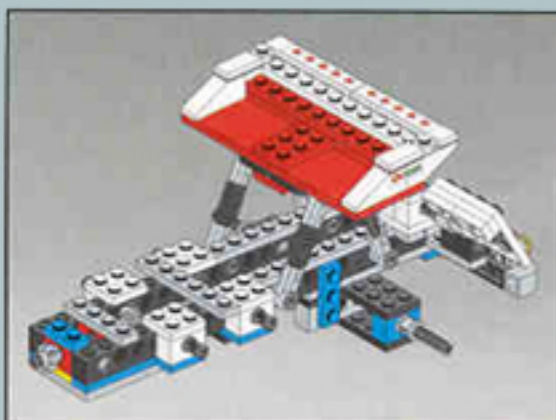

17

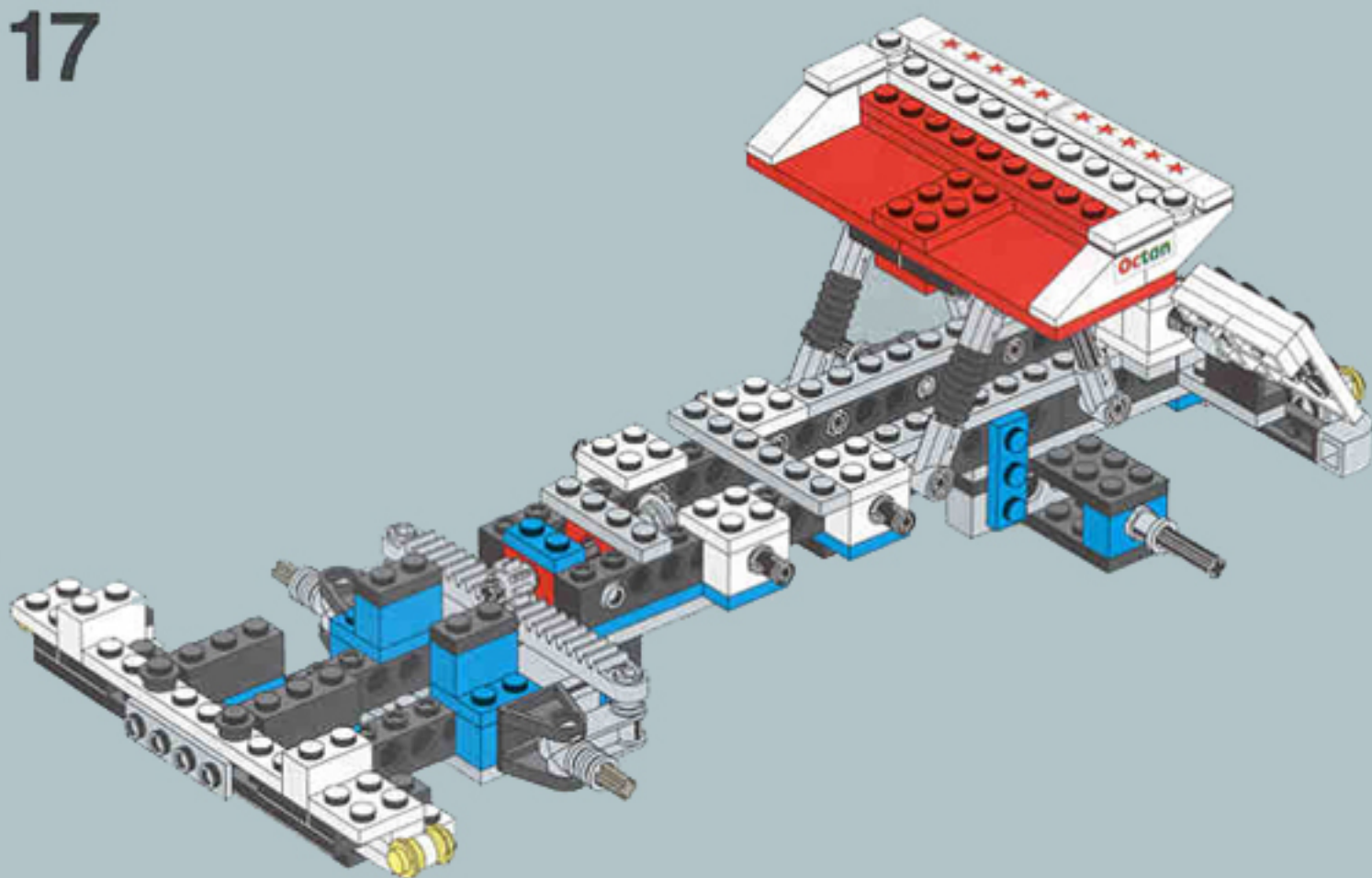

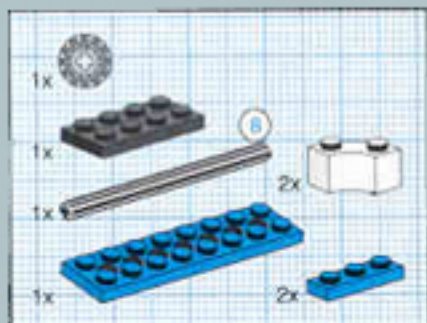

18

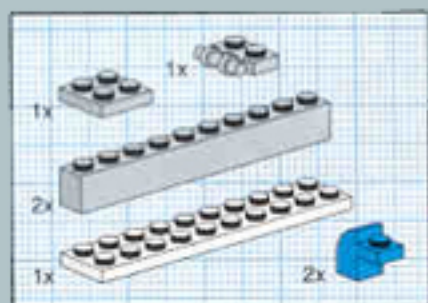
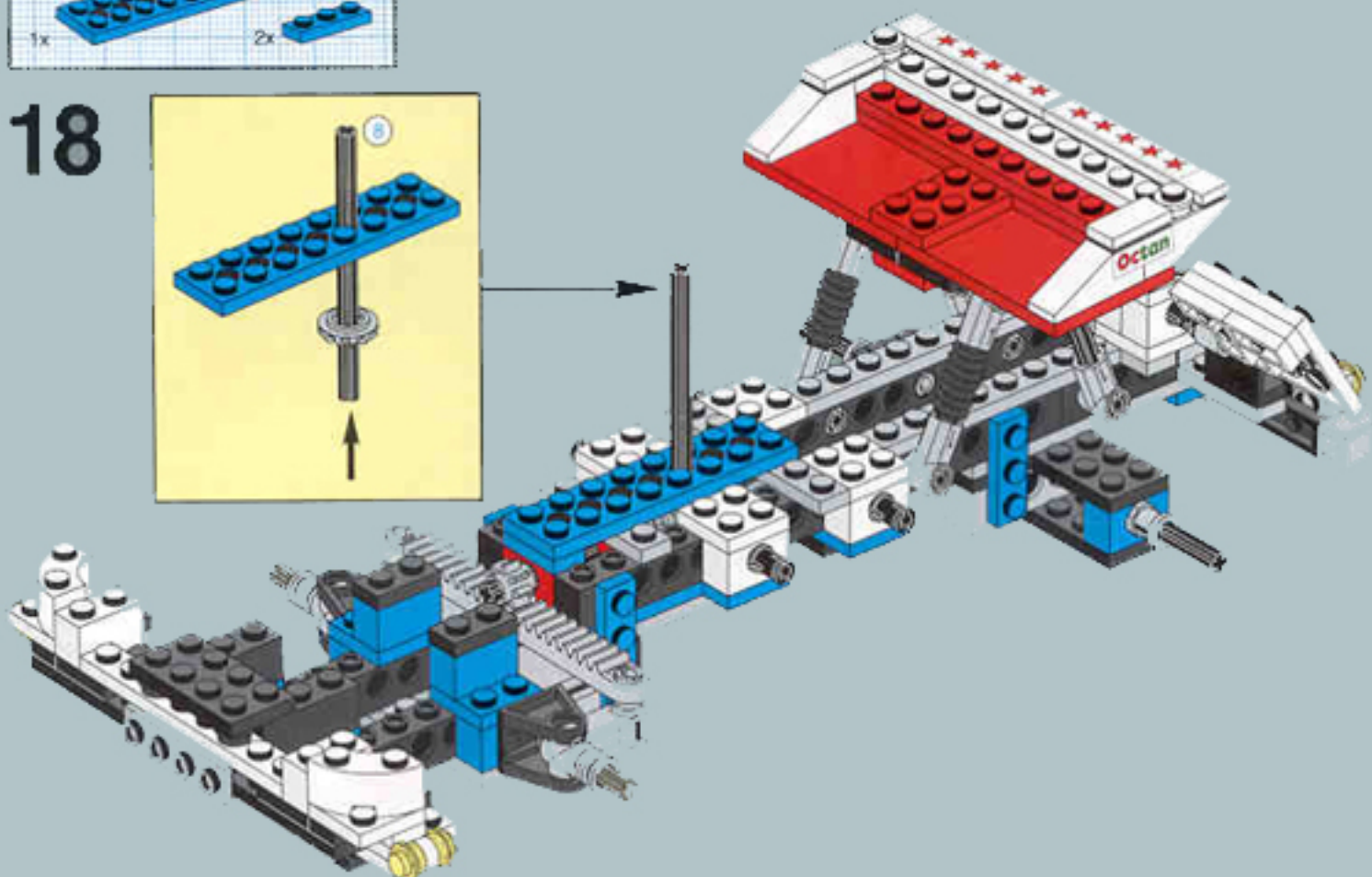
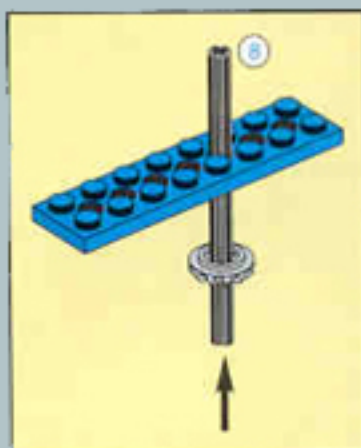

19

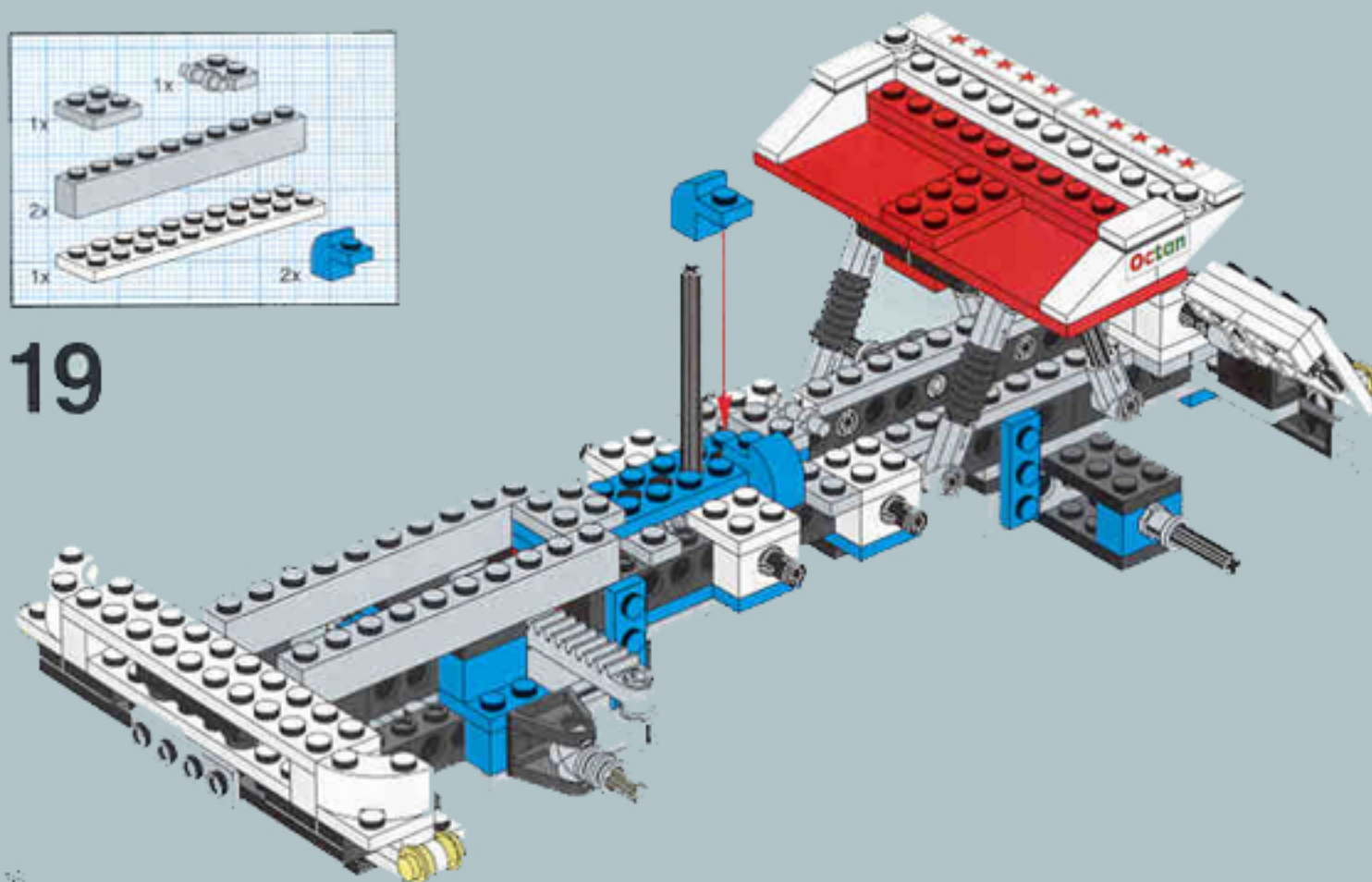





20

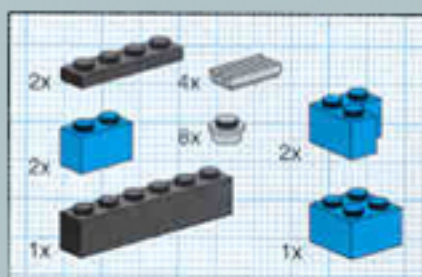
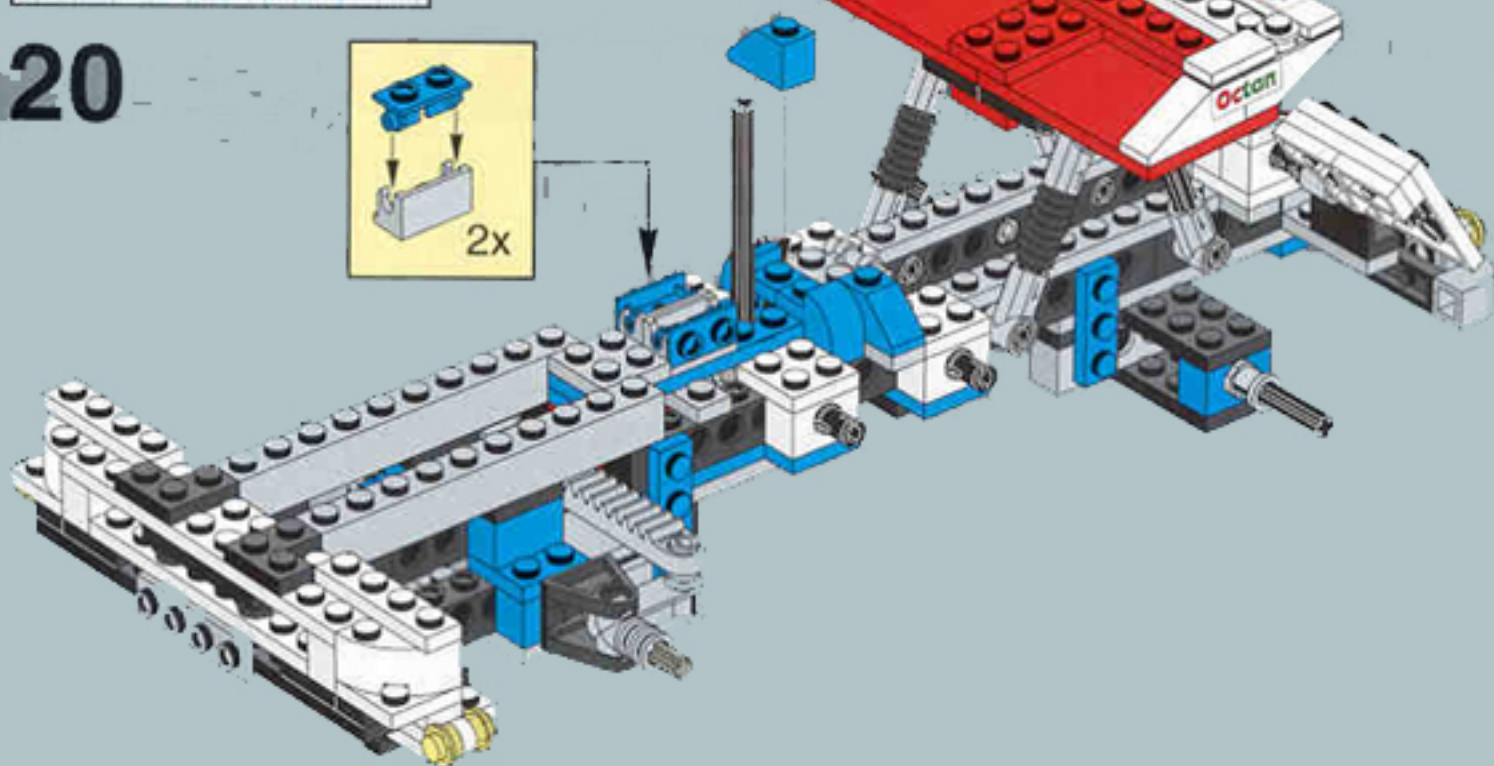

21

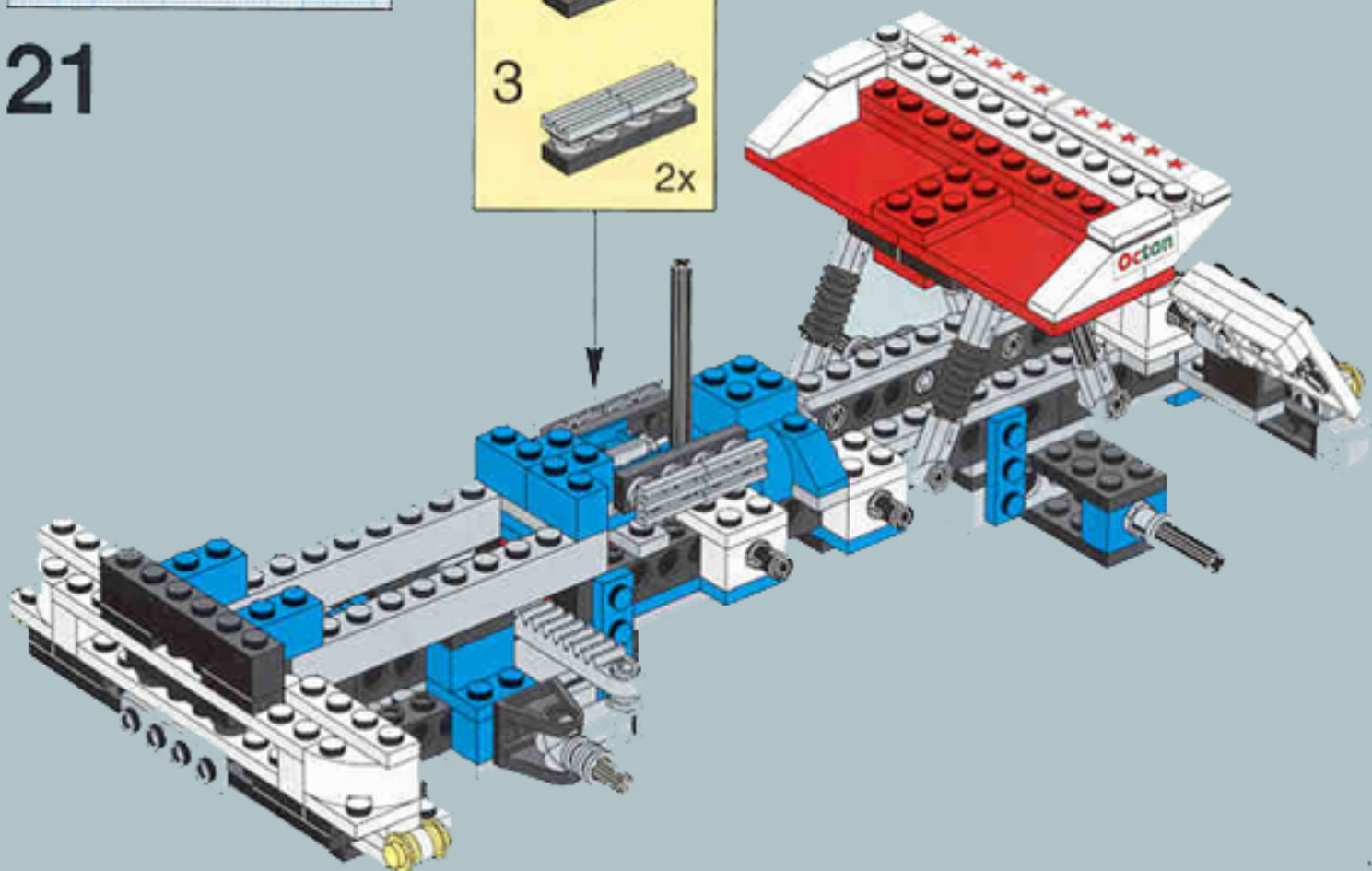
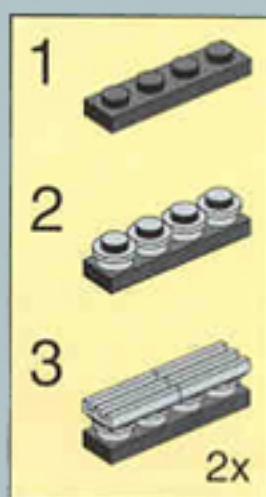



22

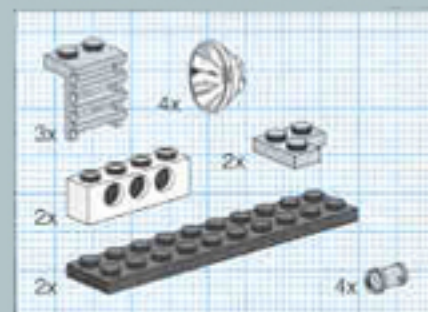
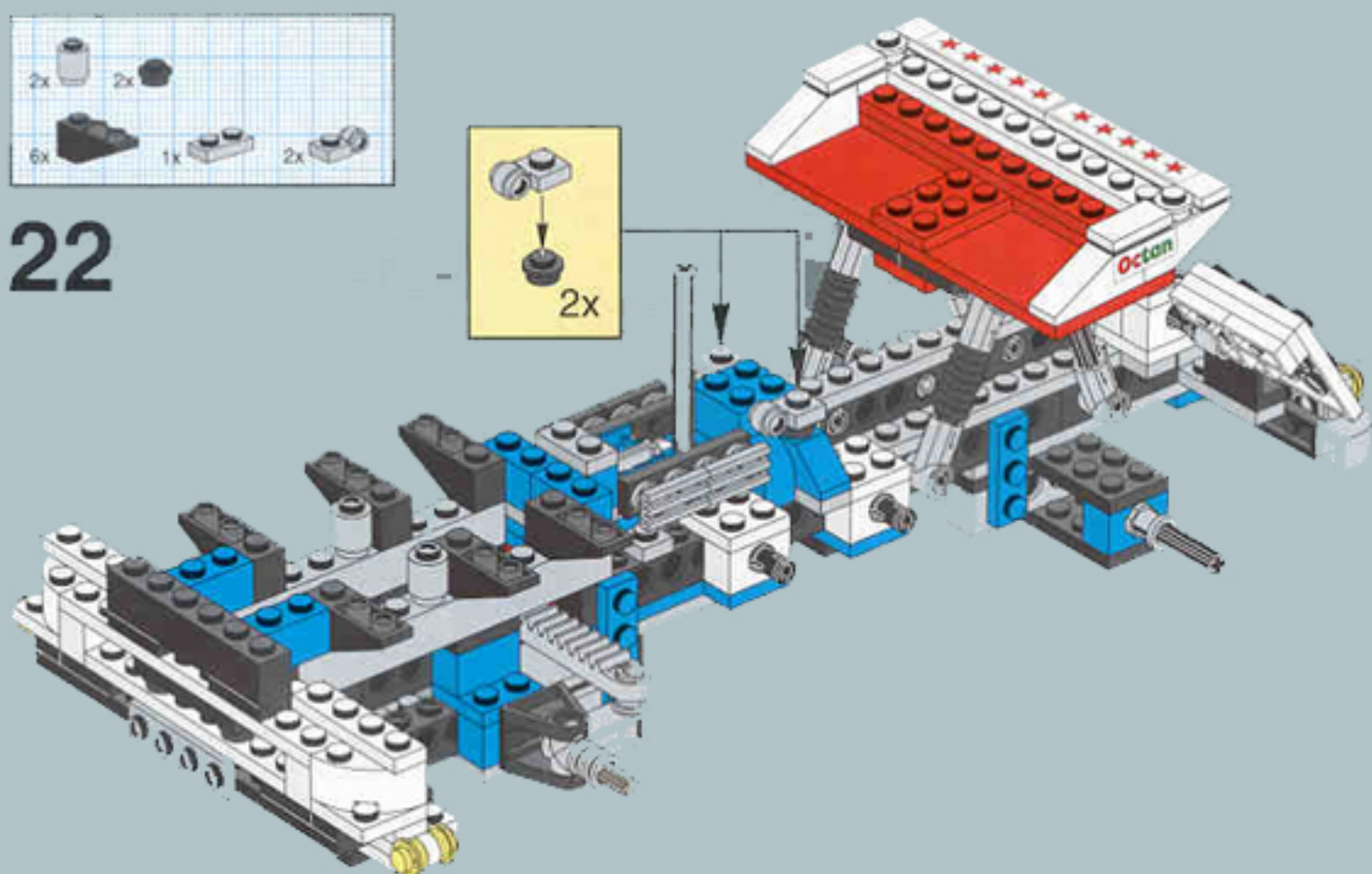

23

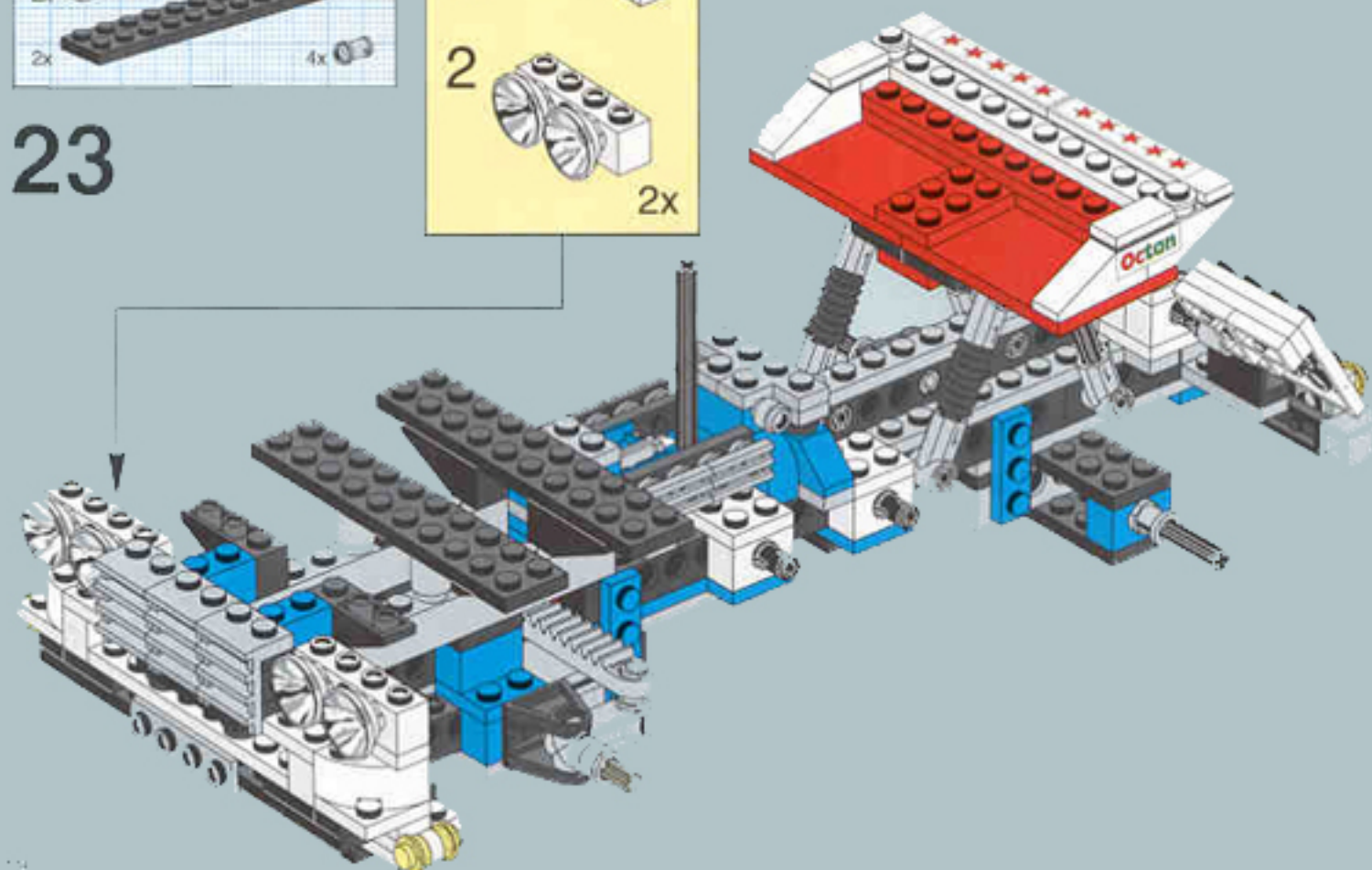
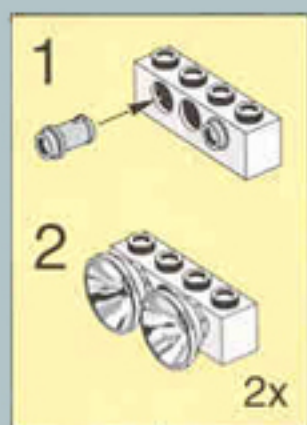

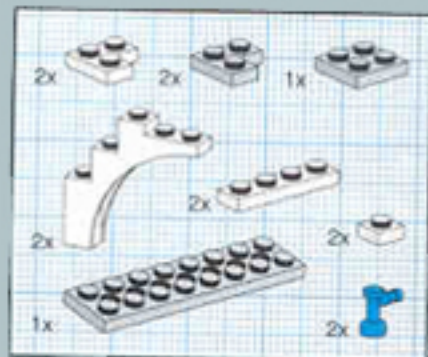

24

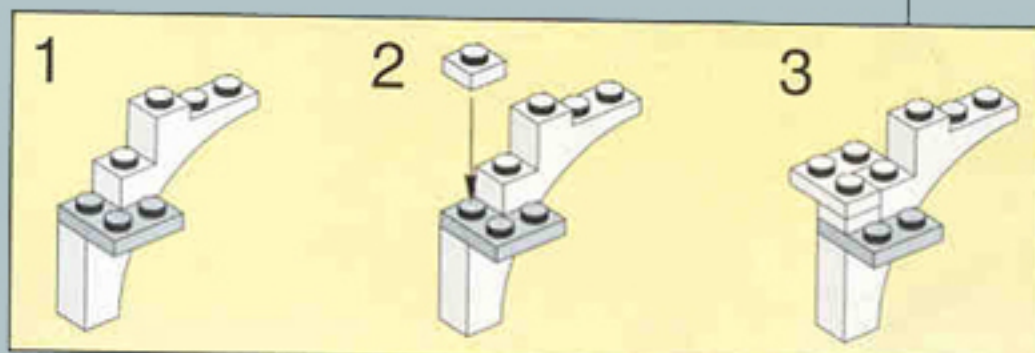
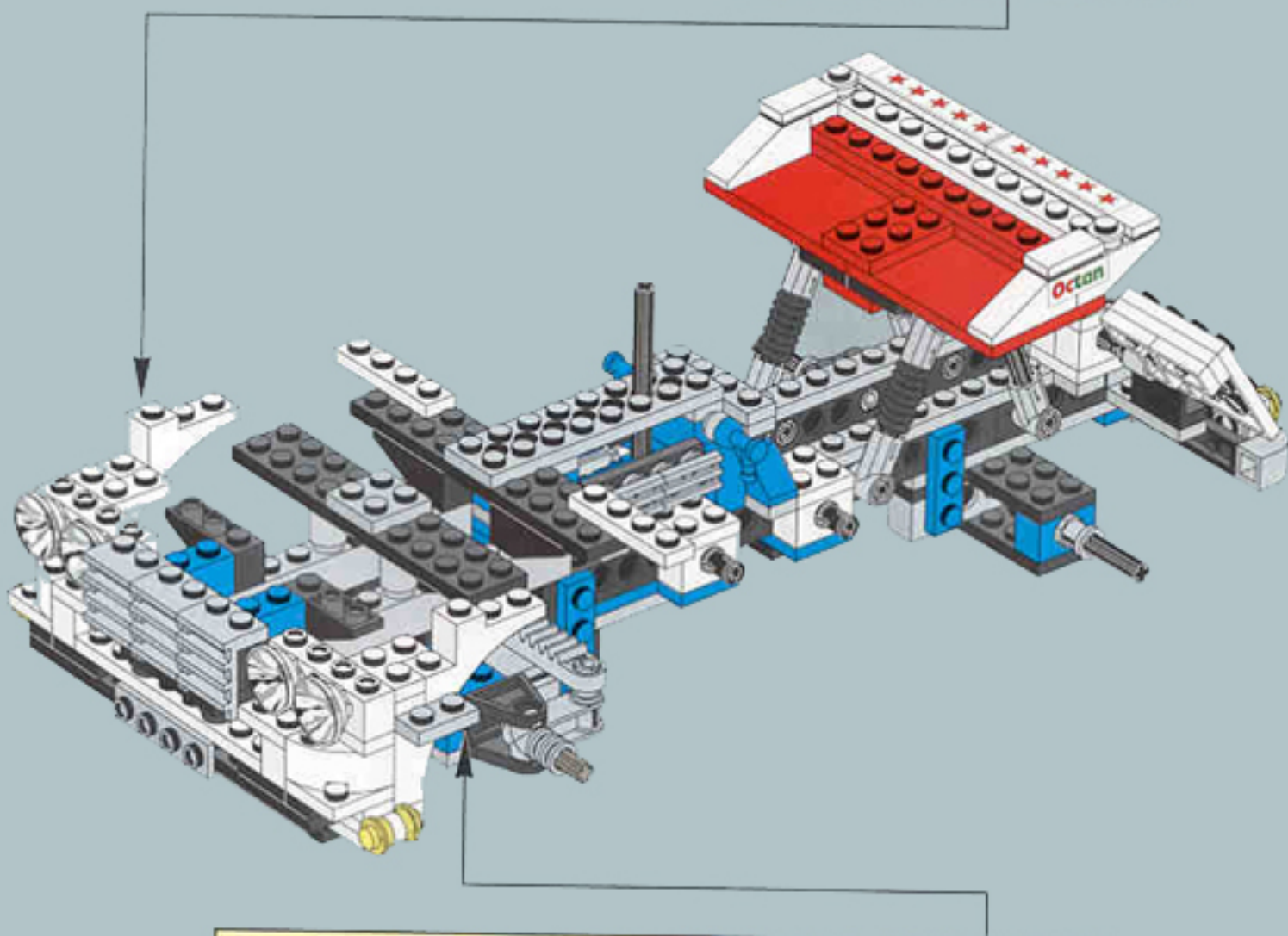
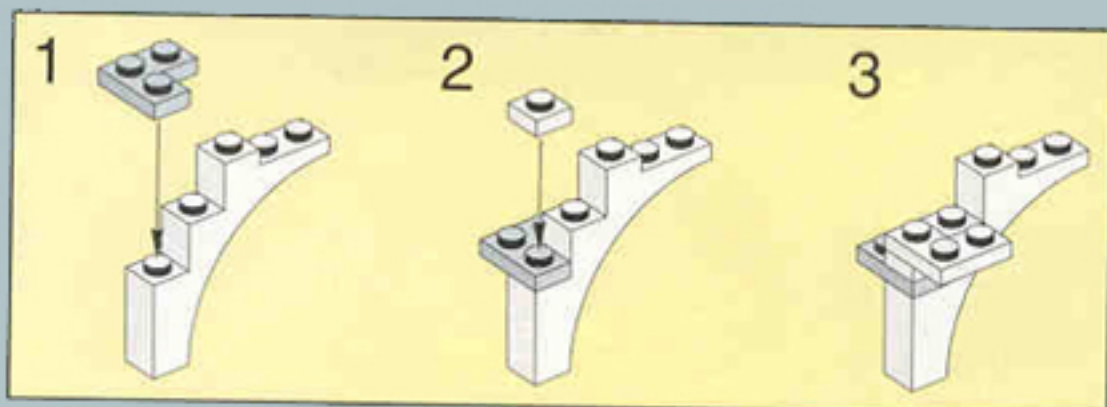

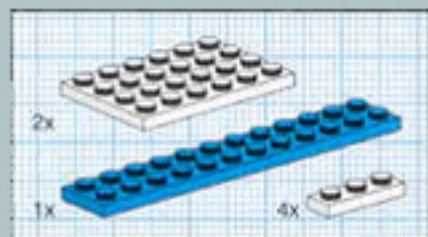

# 25

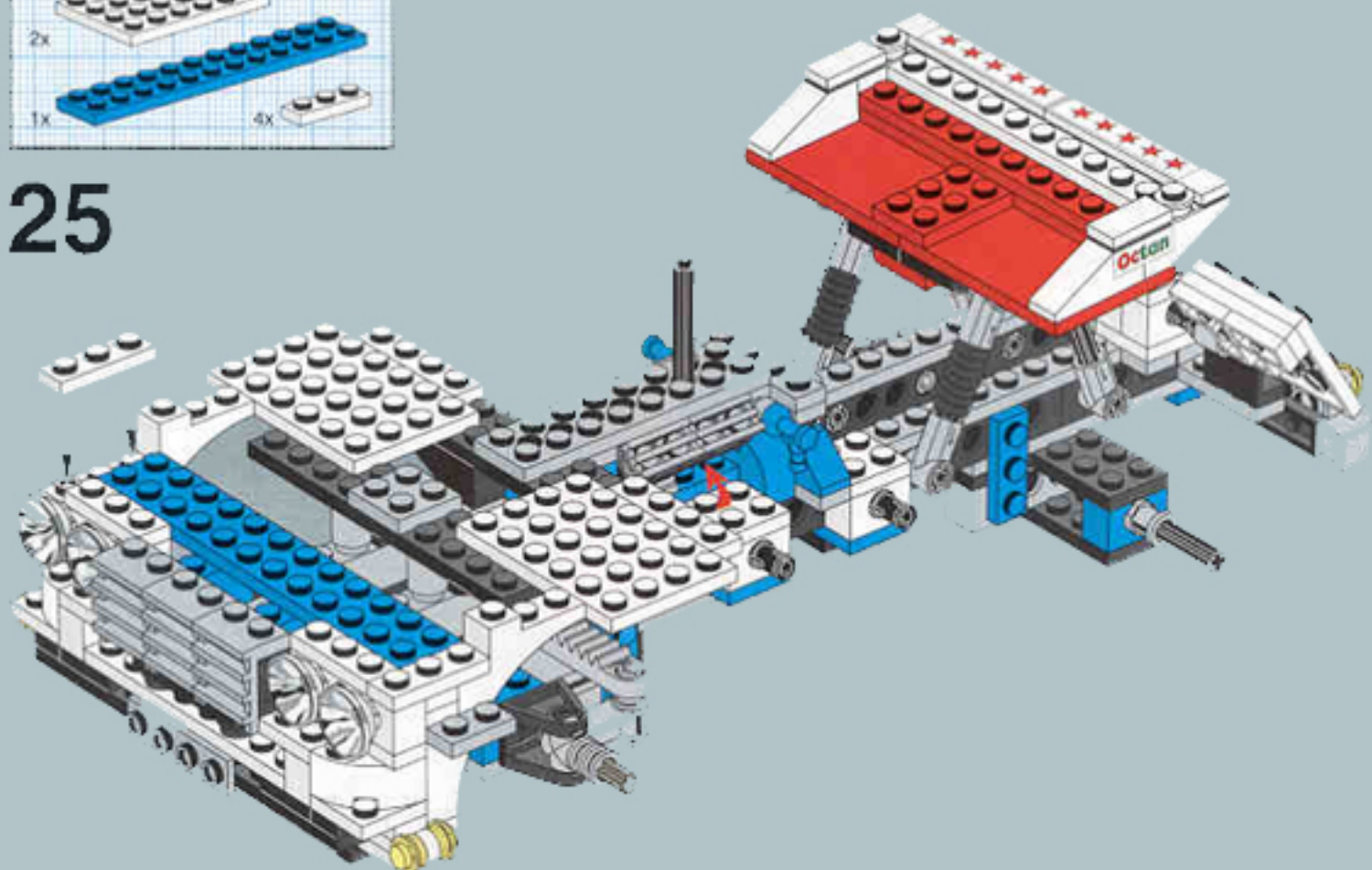

# 26

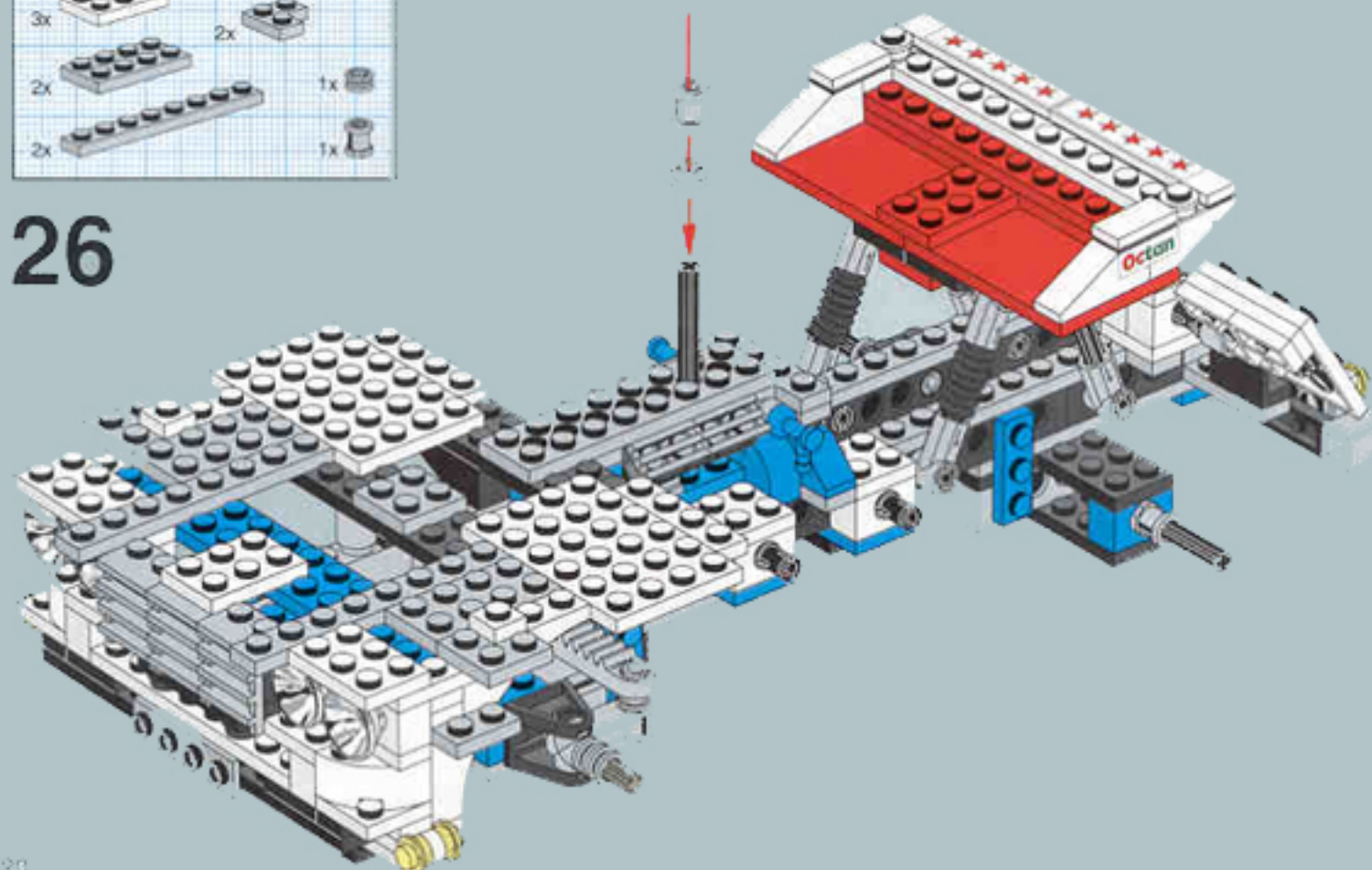

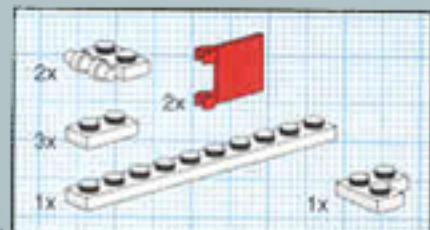

27

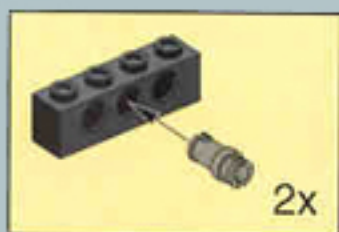
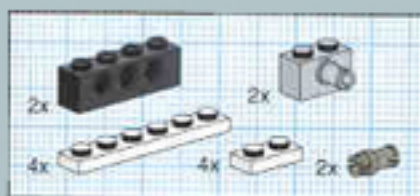
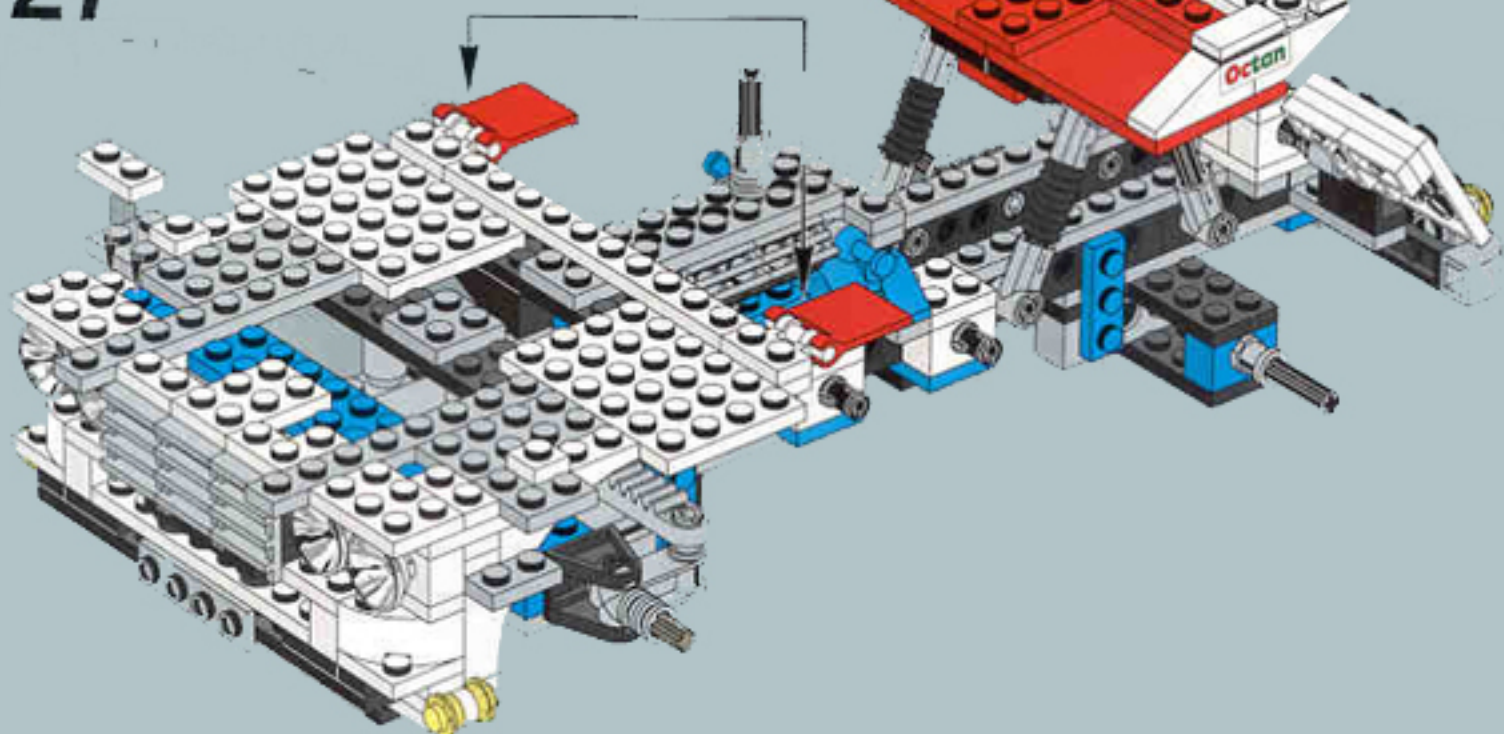

28

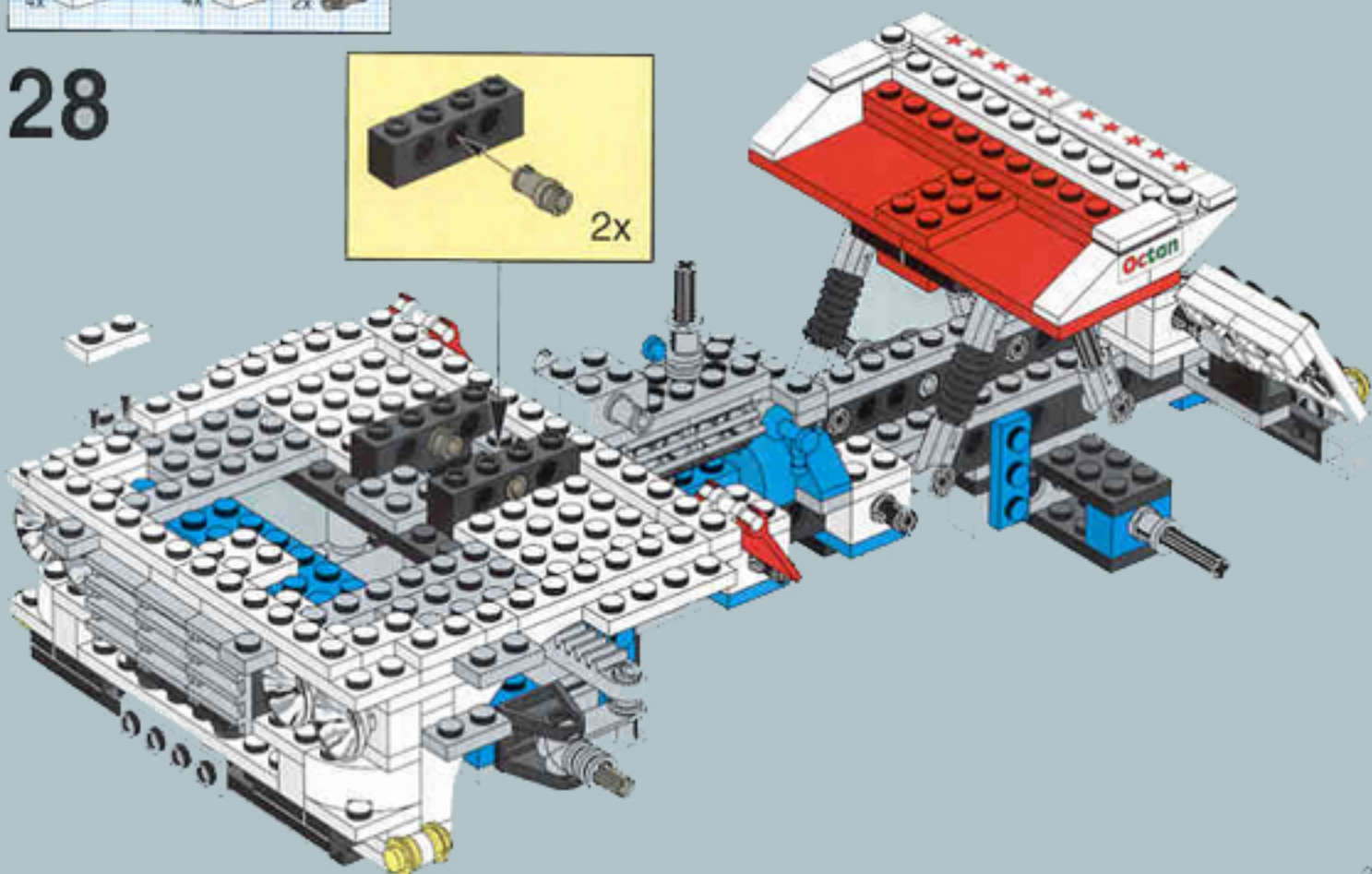



# 29

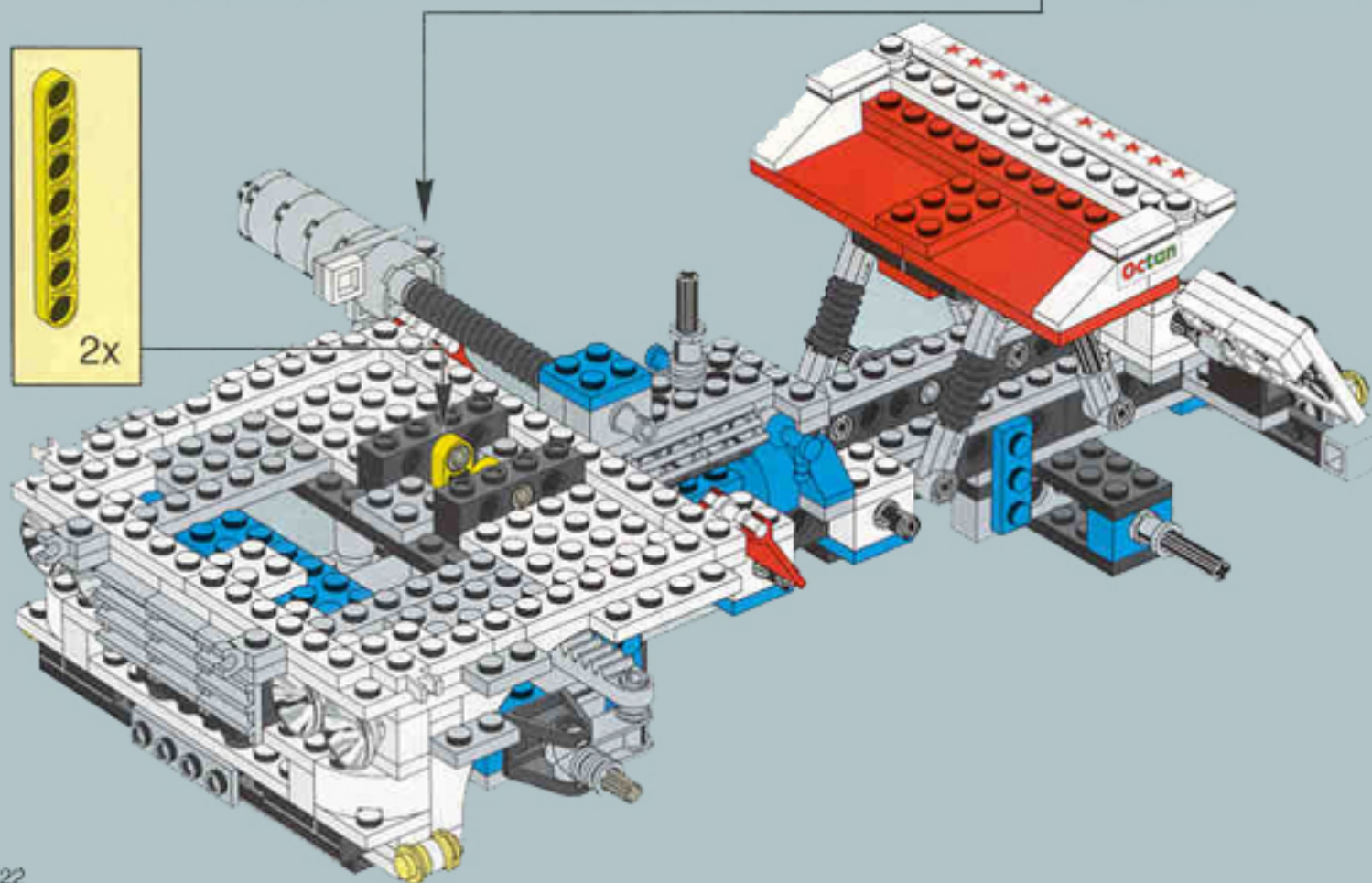
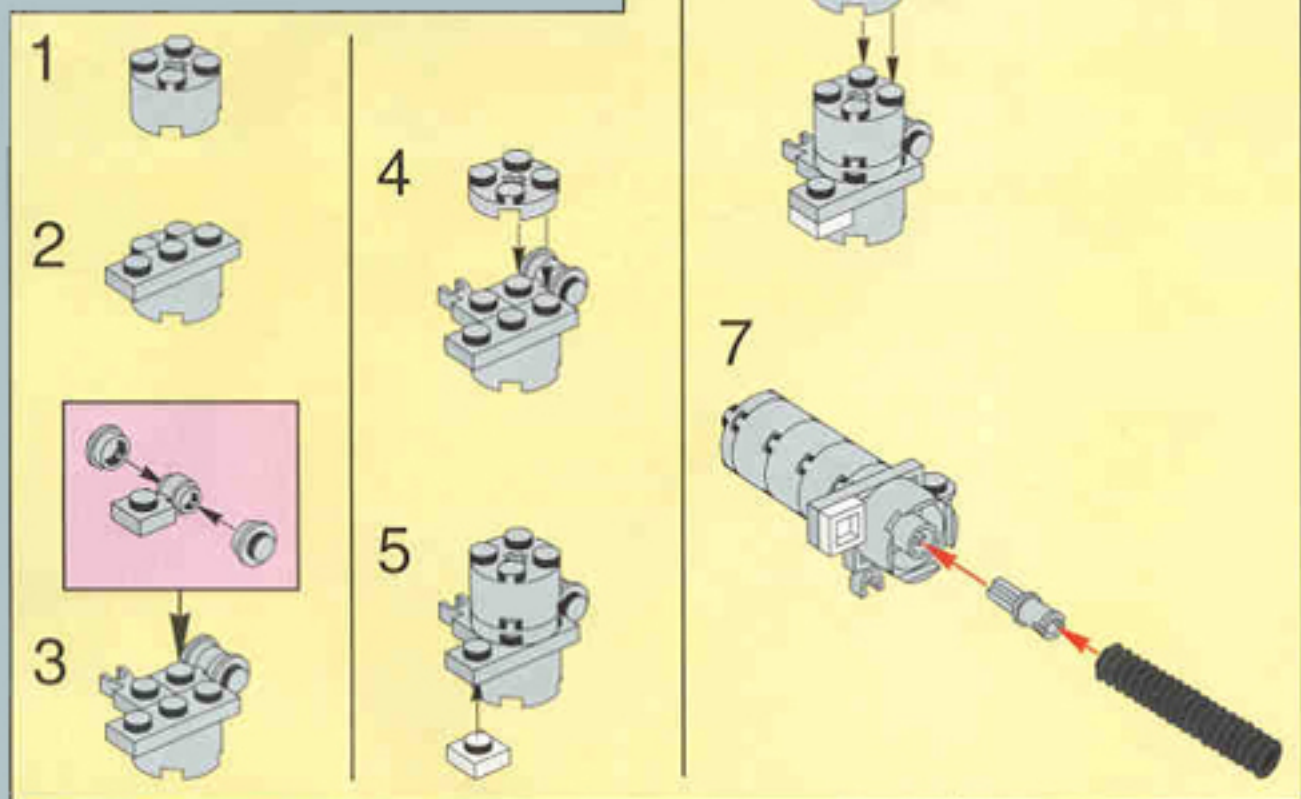

# 30

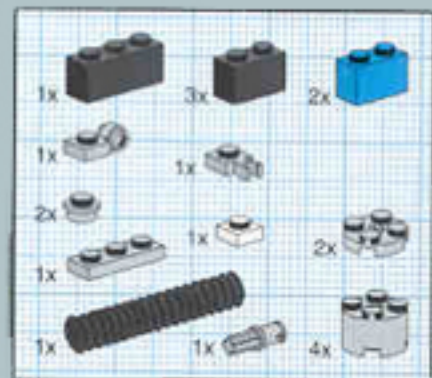

**1**

**2**

**3**

**4**

**5**

**6**

**7**

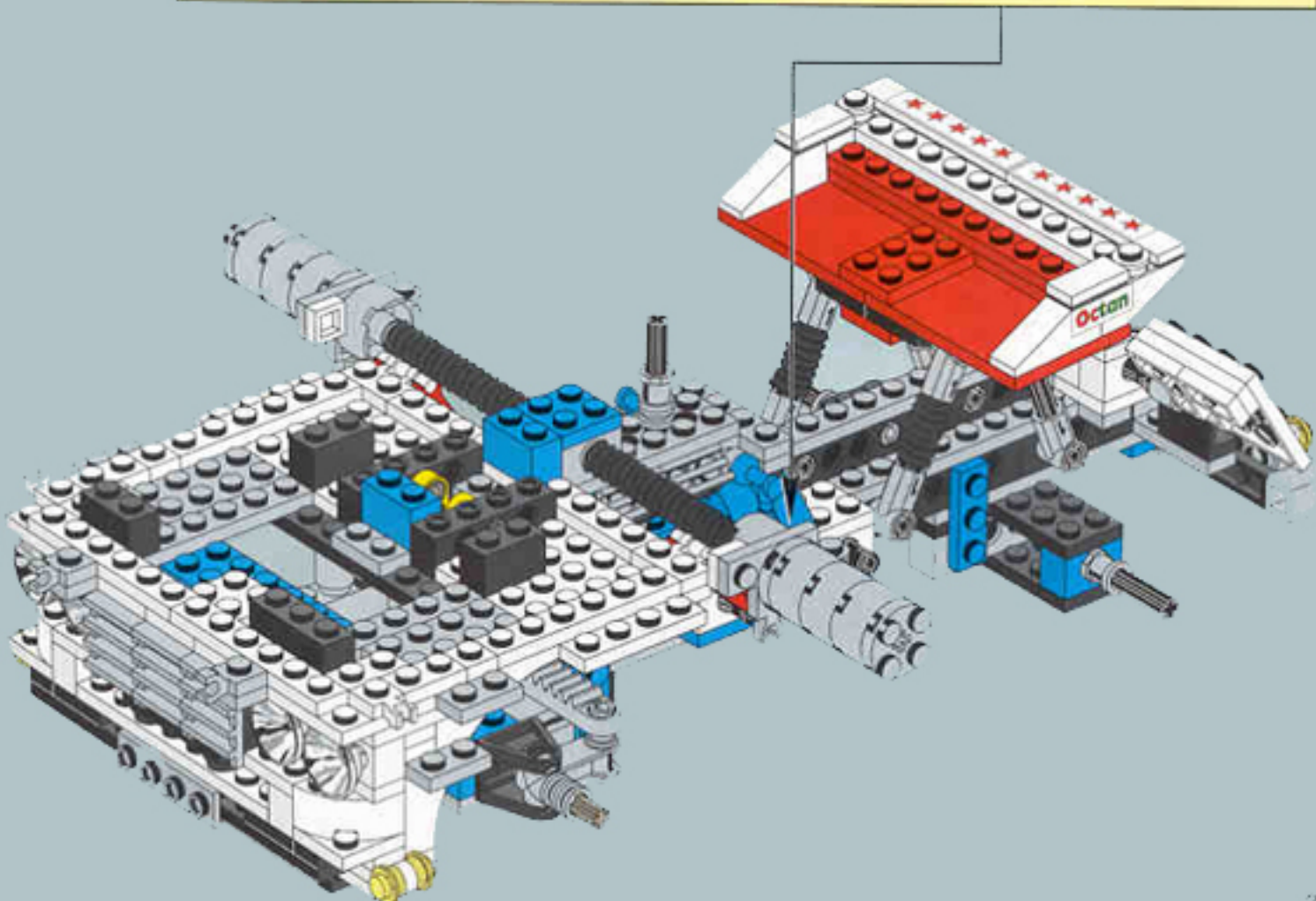

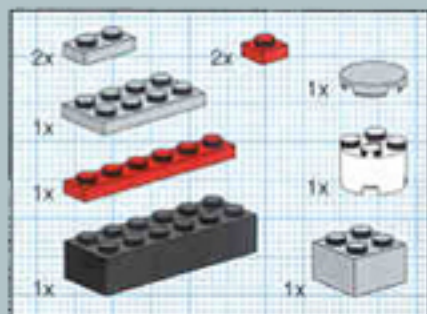

# 31

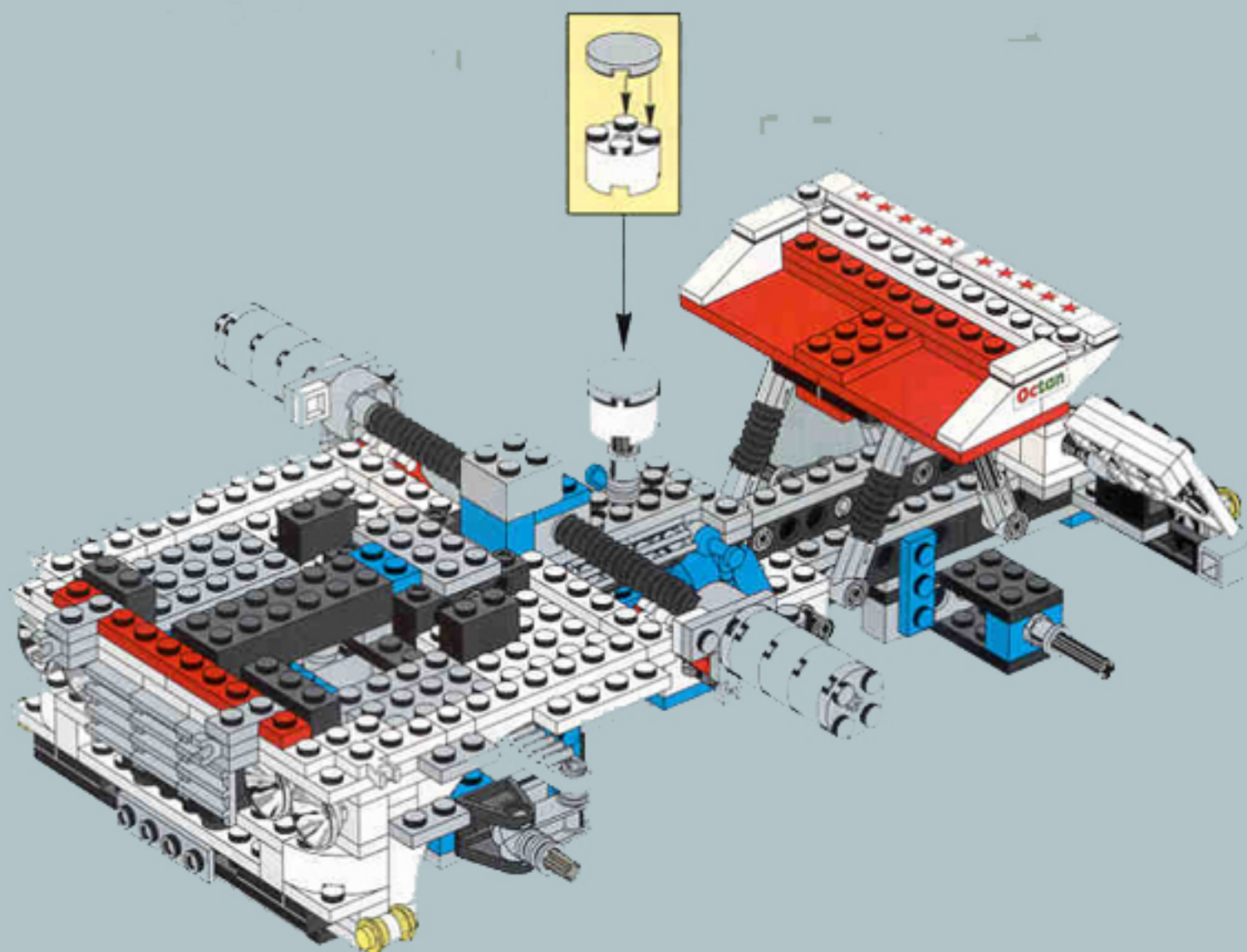



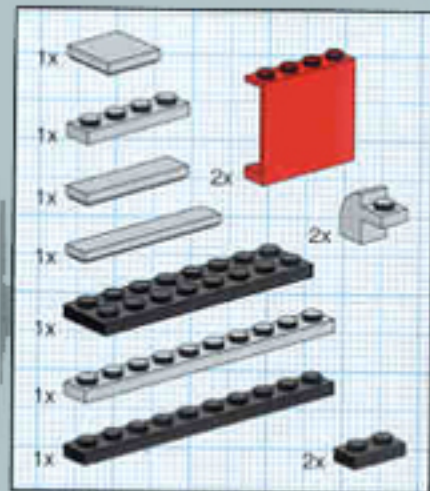

32

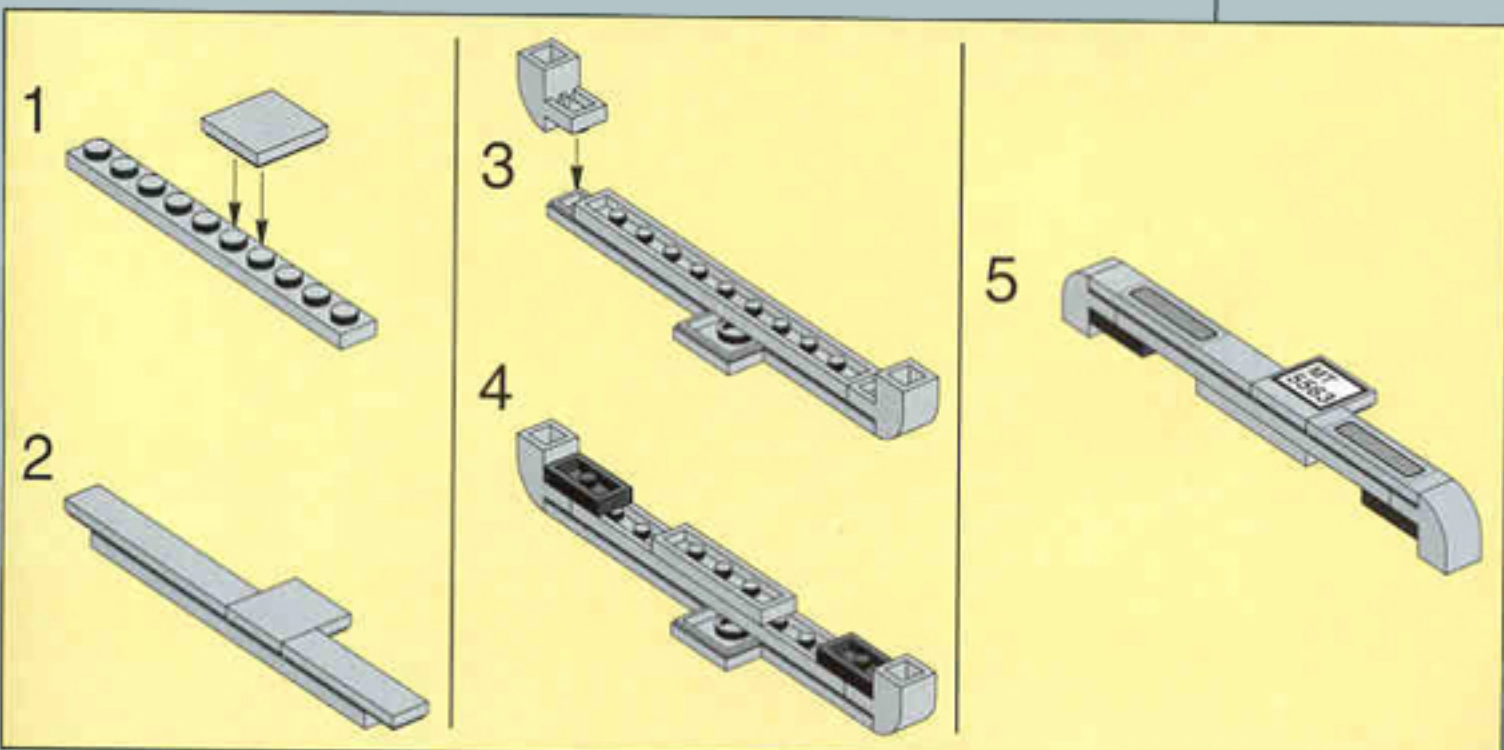
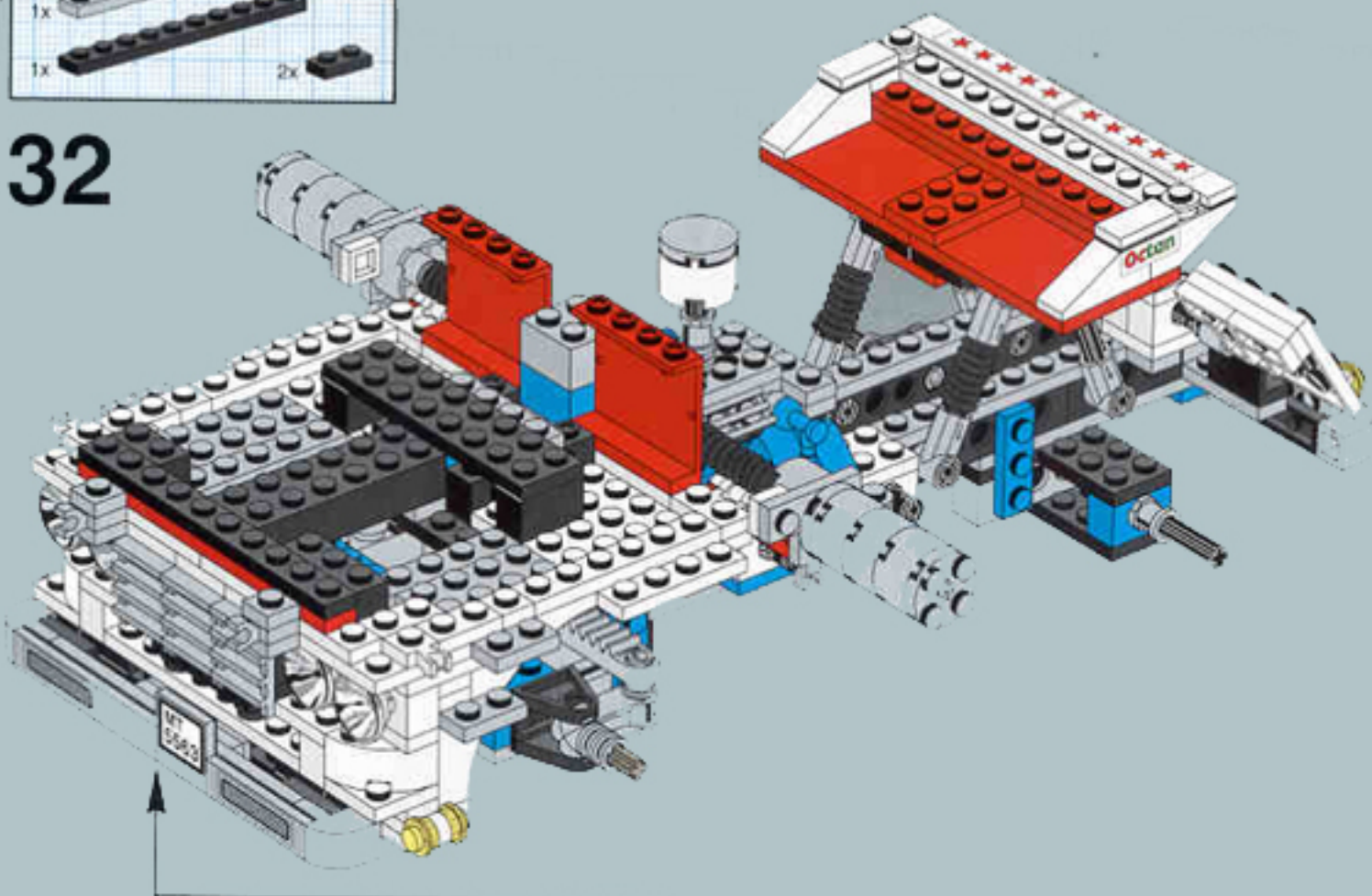

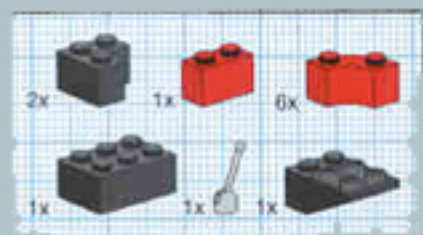

33

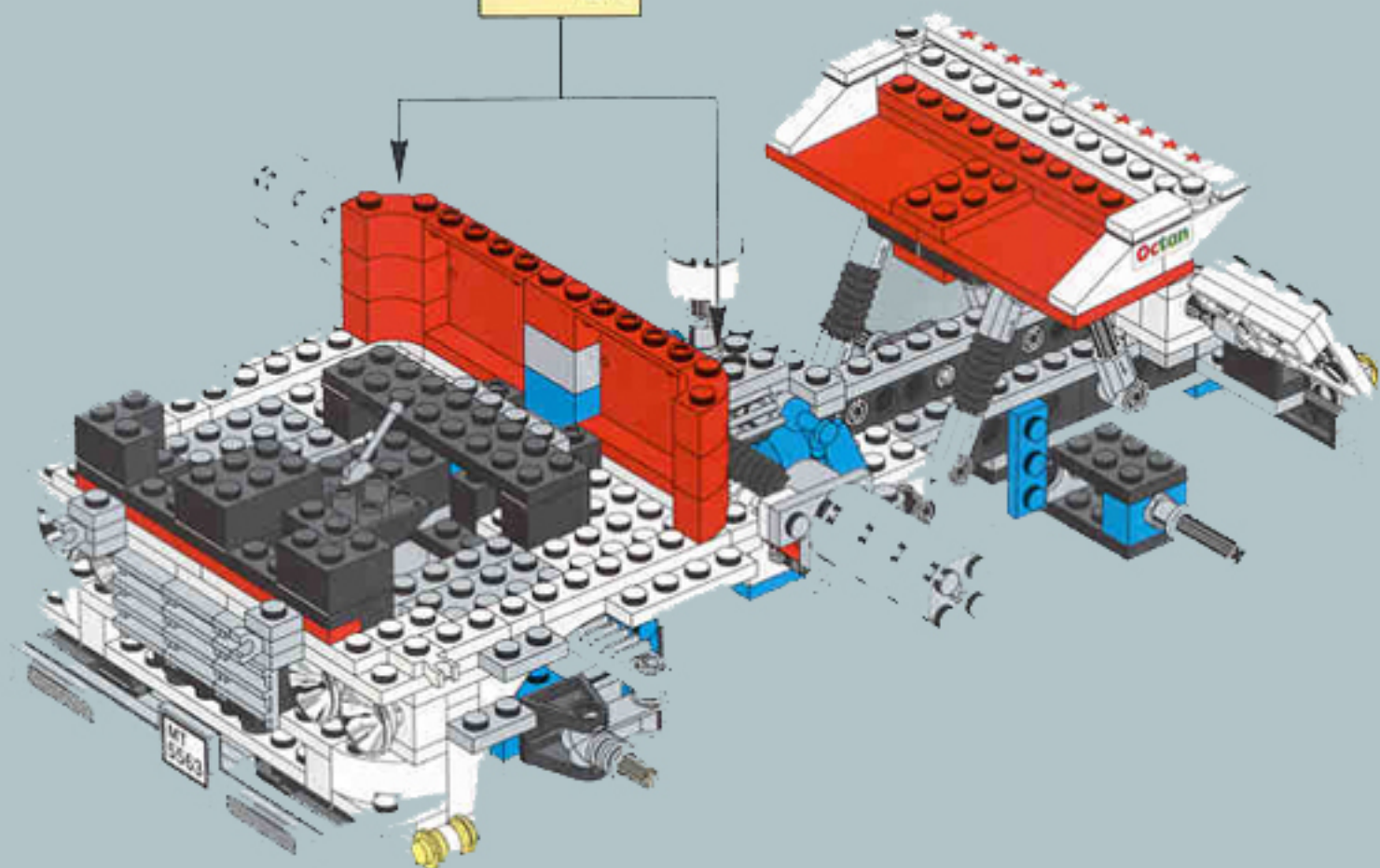
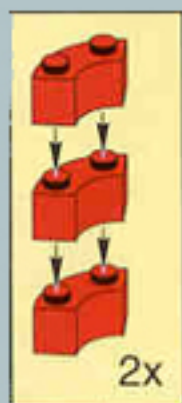

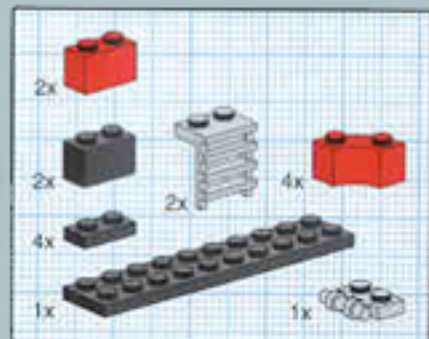

# 34

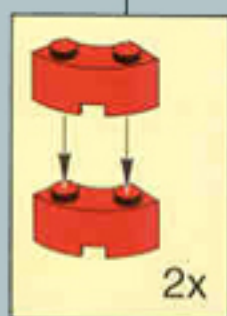
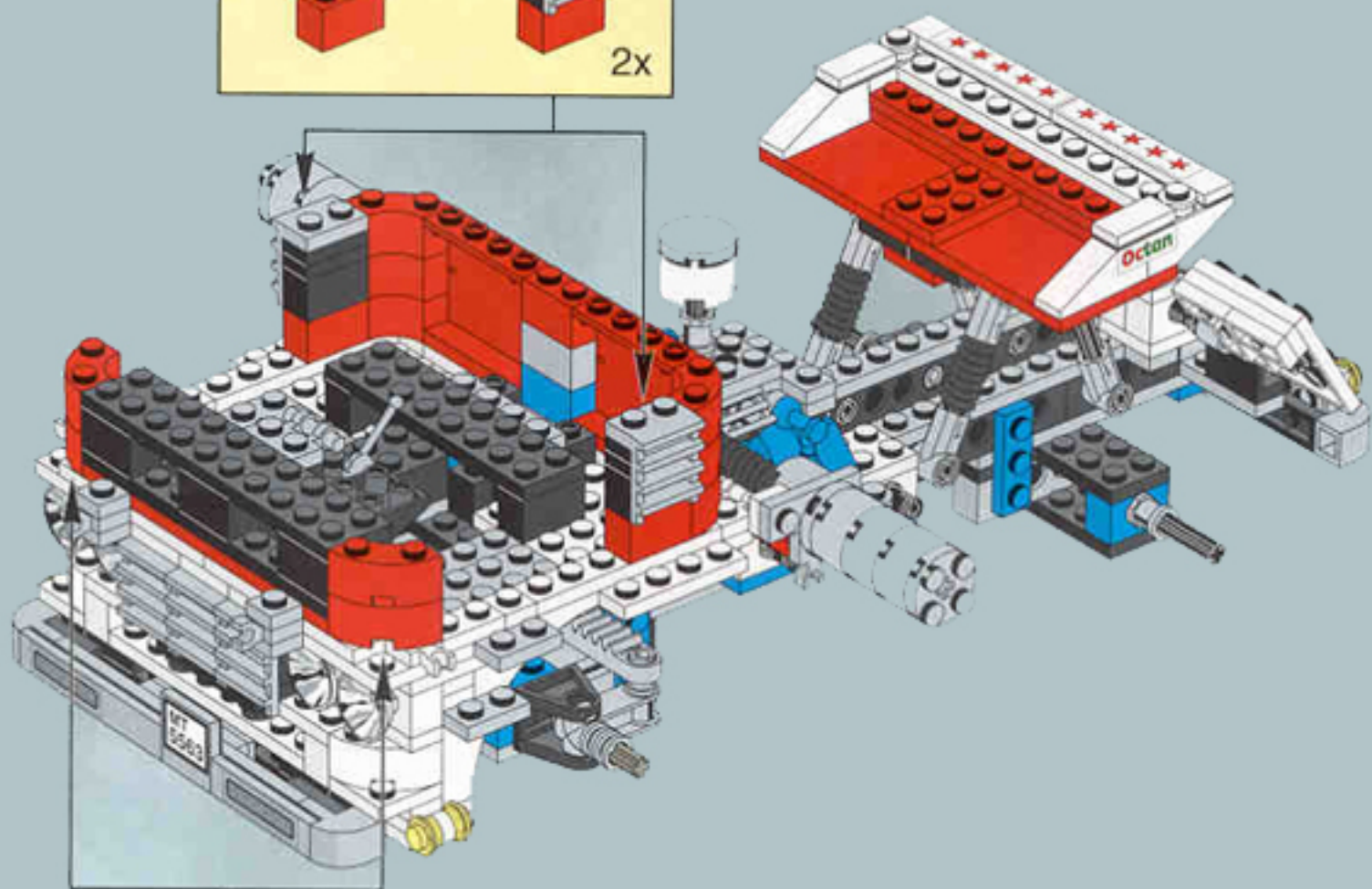
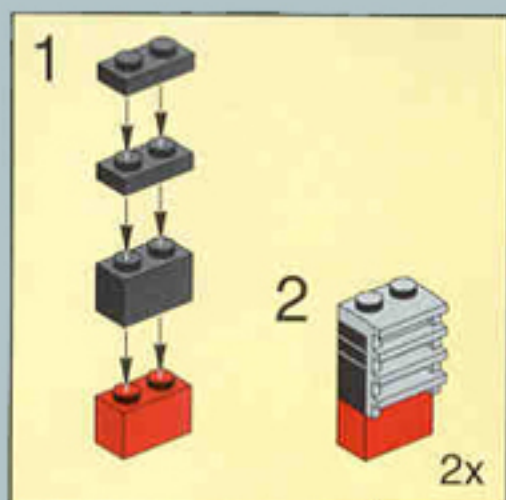



# 35

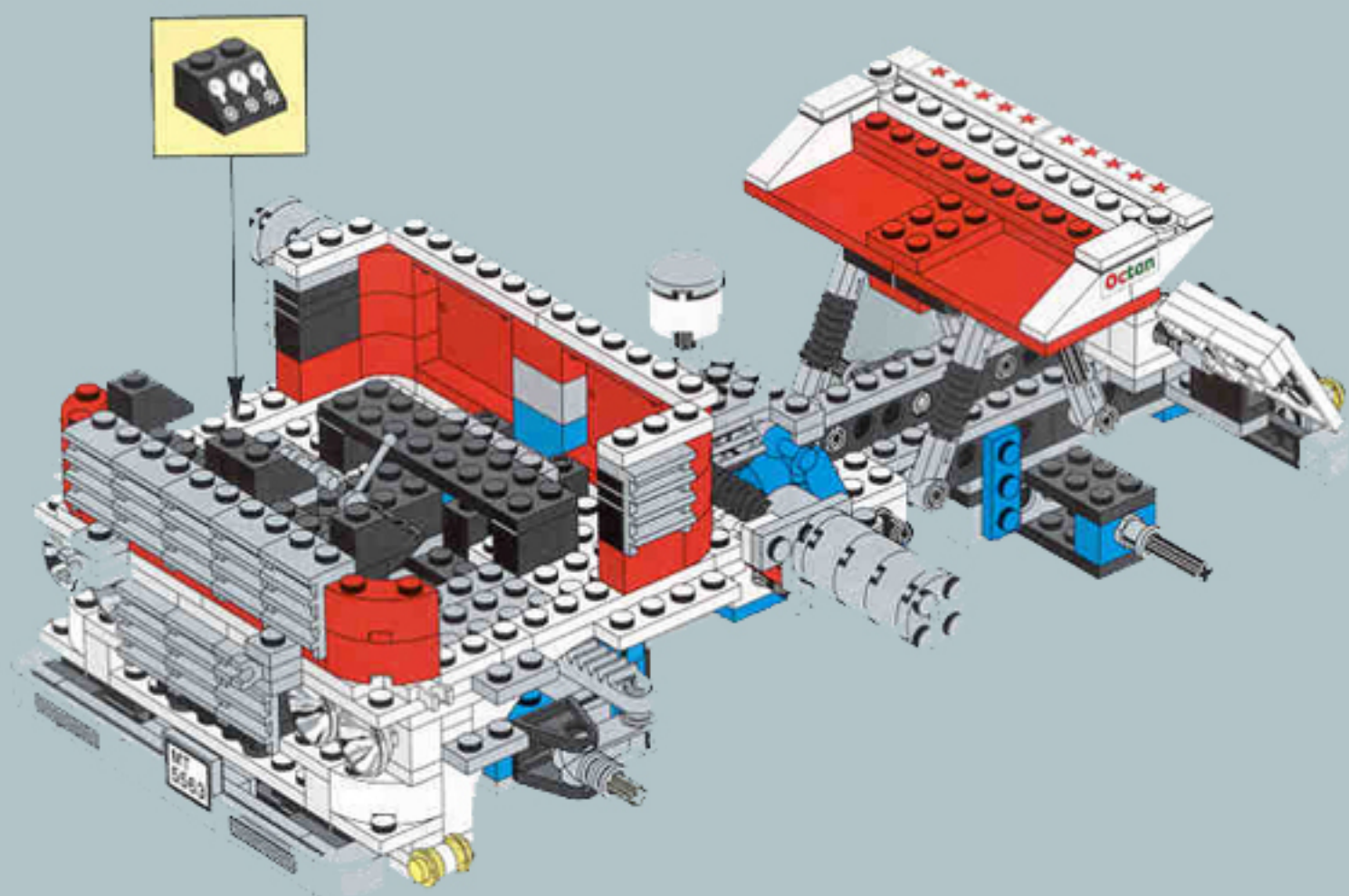

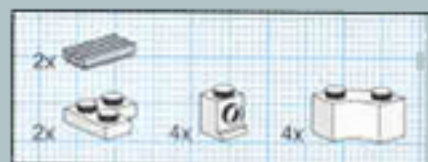

# 36

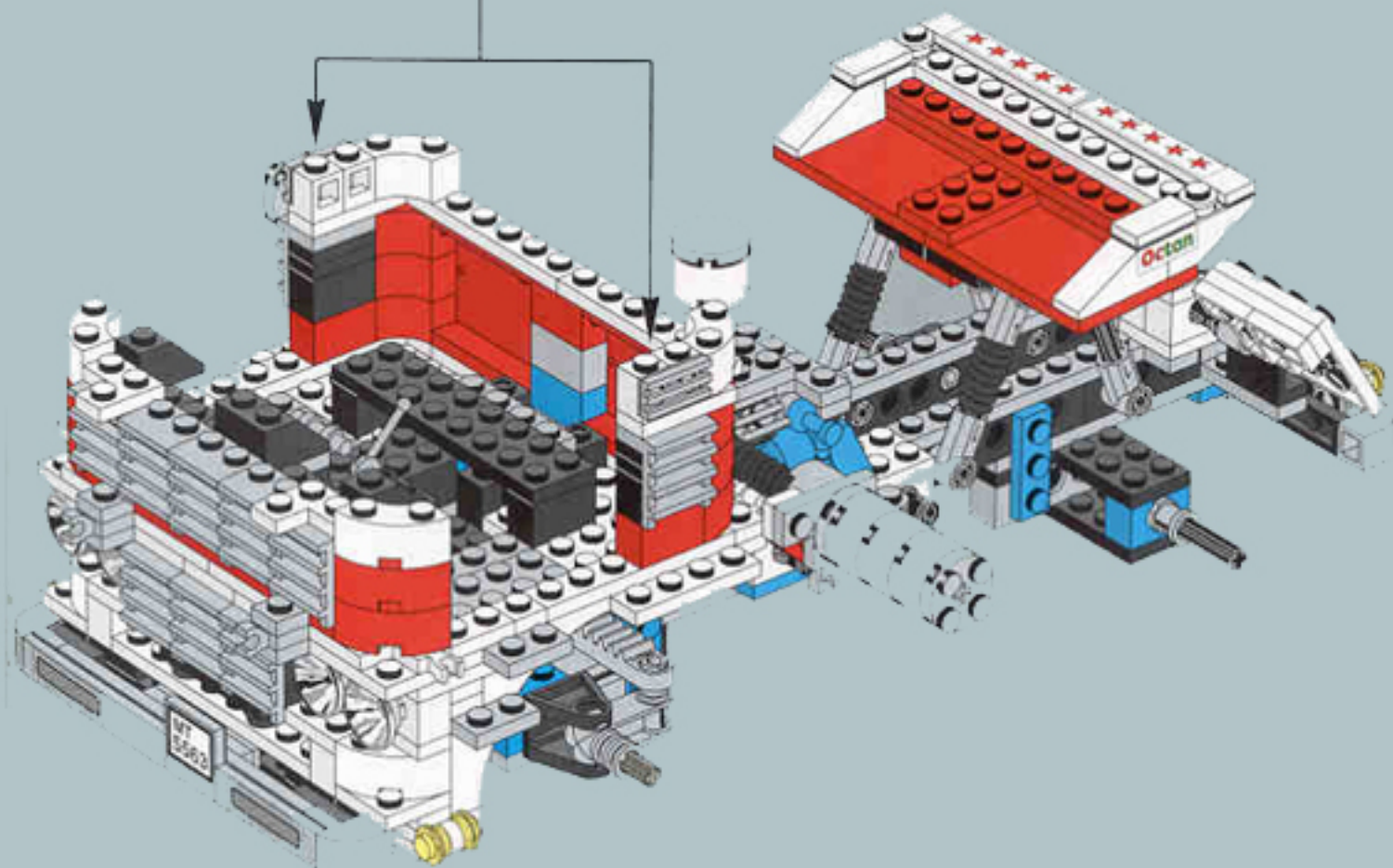
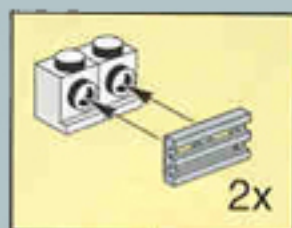



# 37

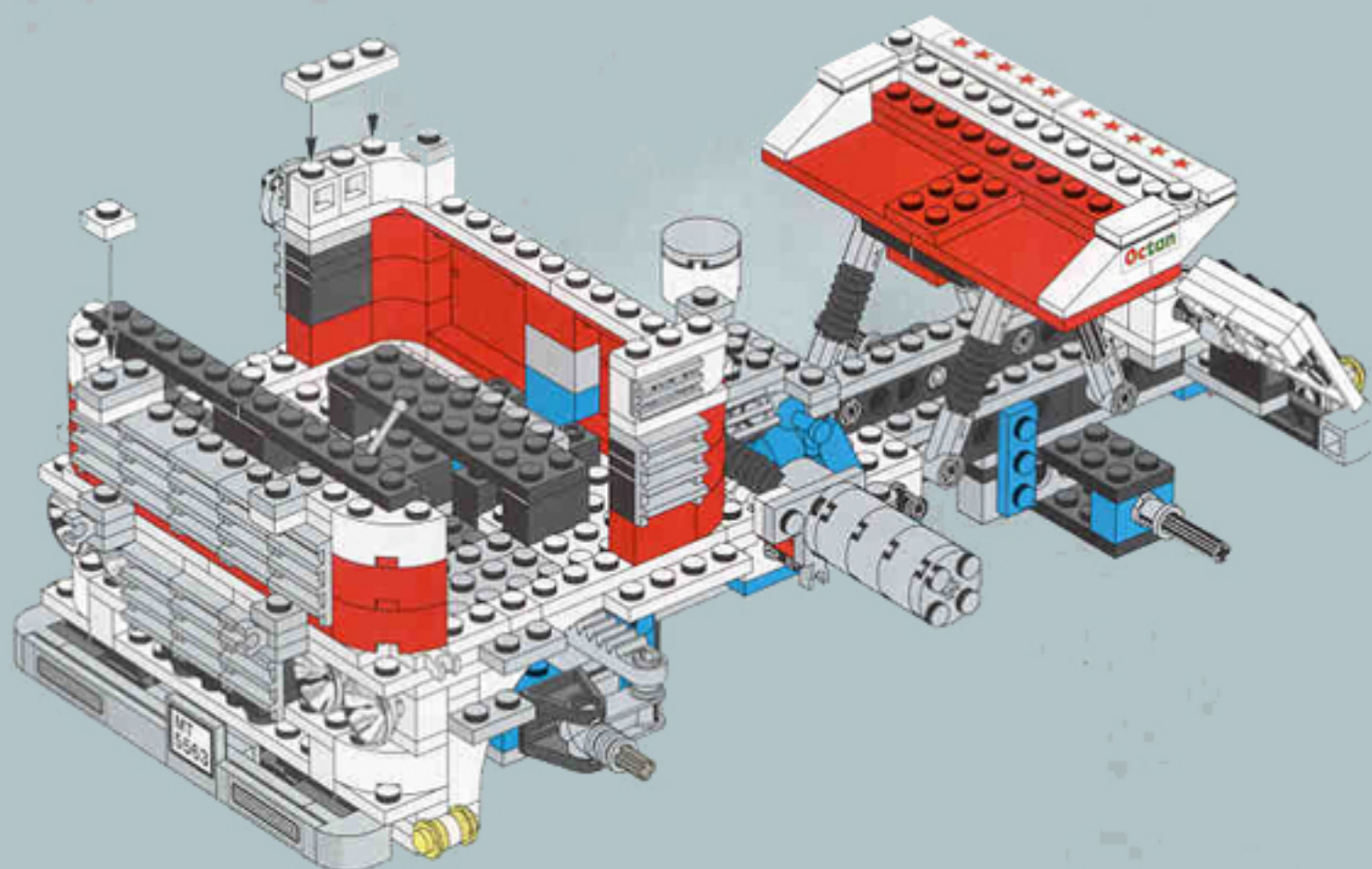



38

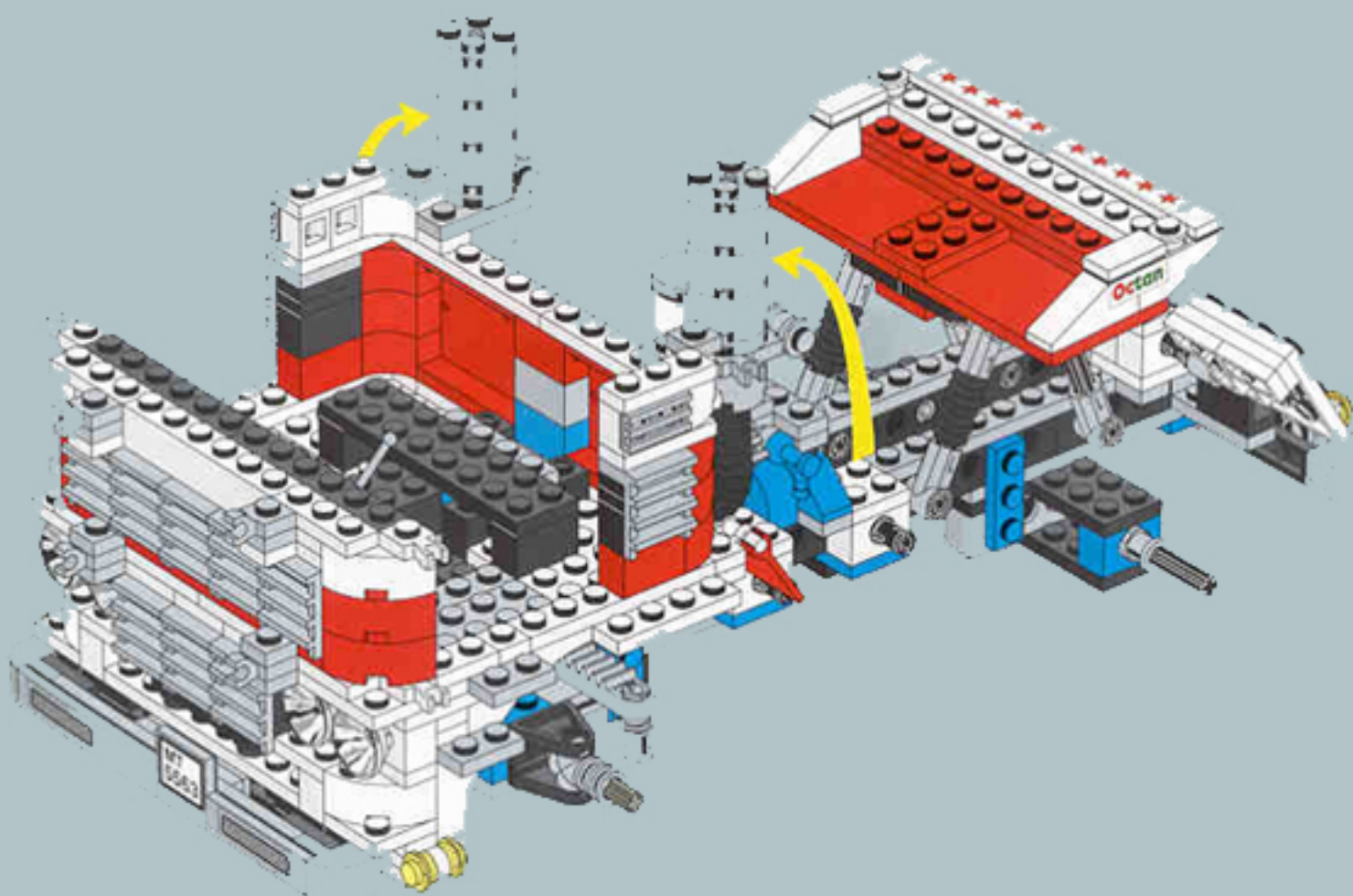

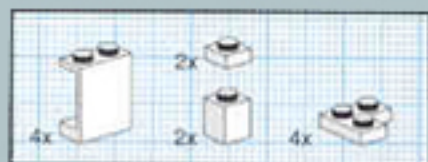

# 39

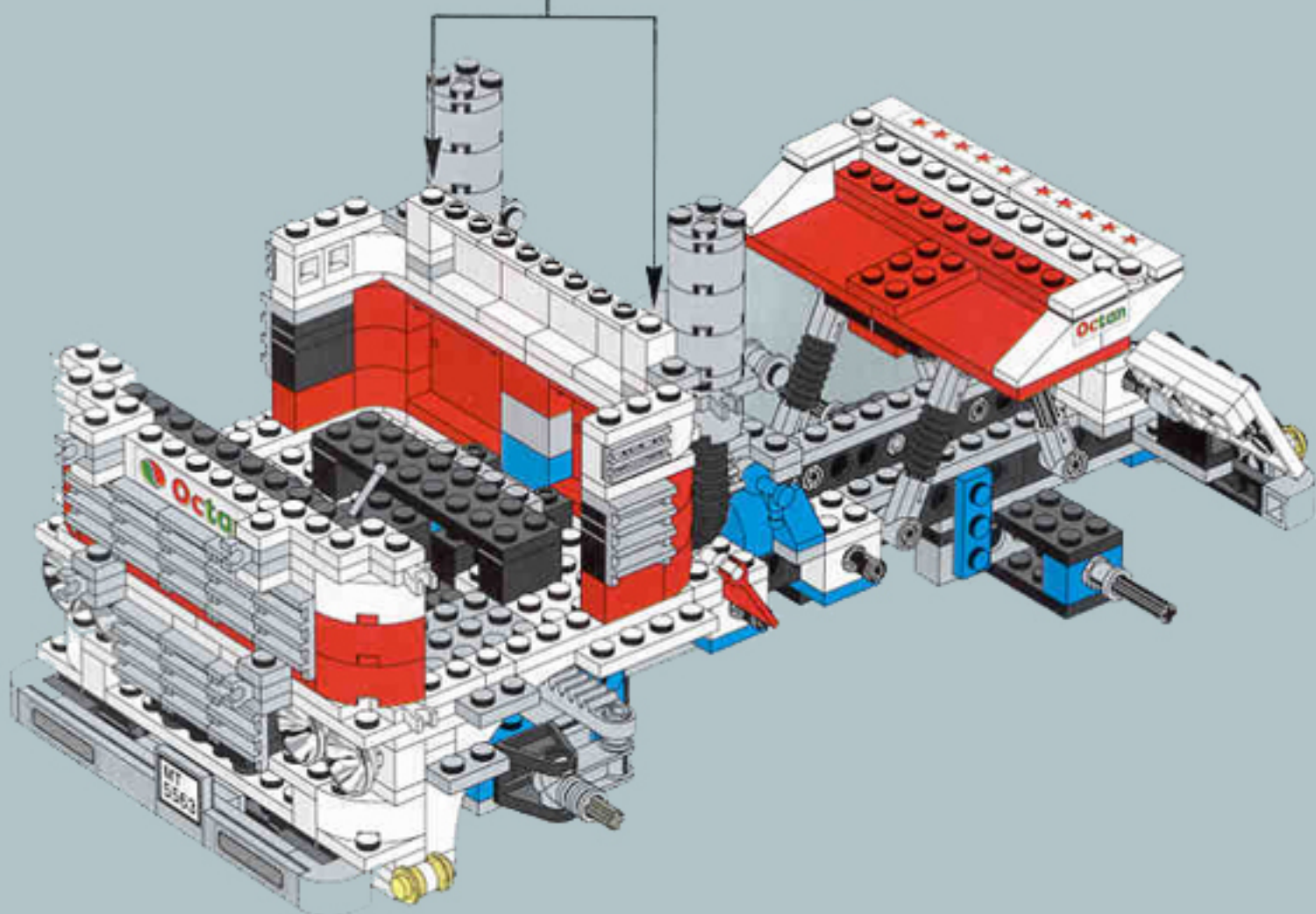
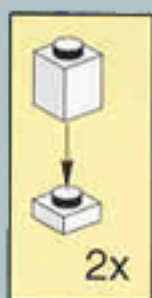







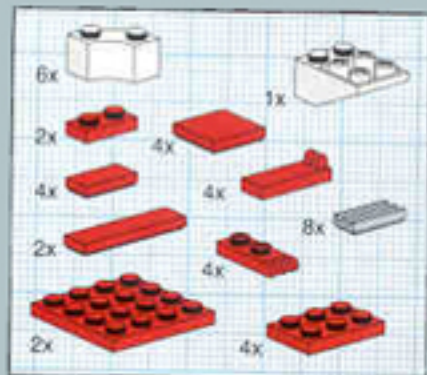

42

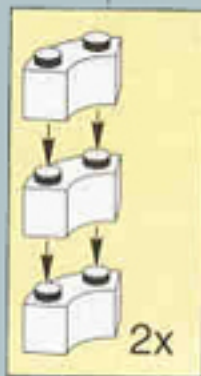
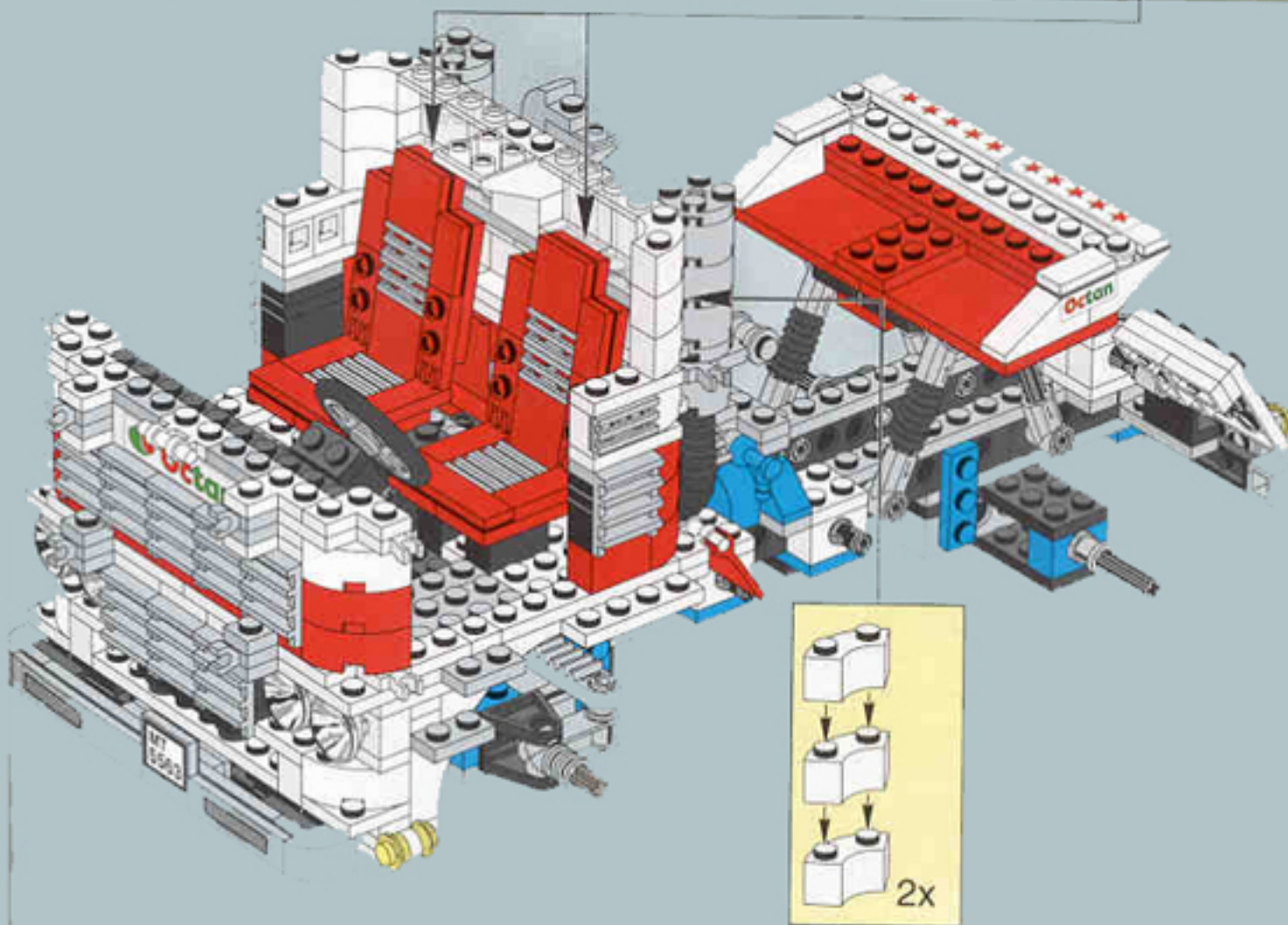
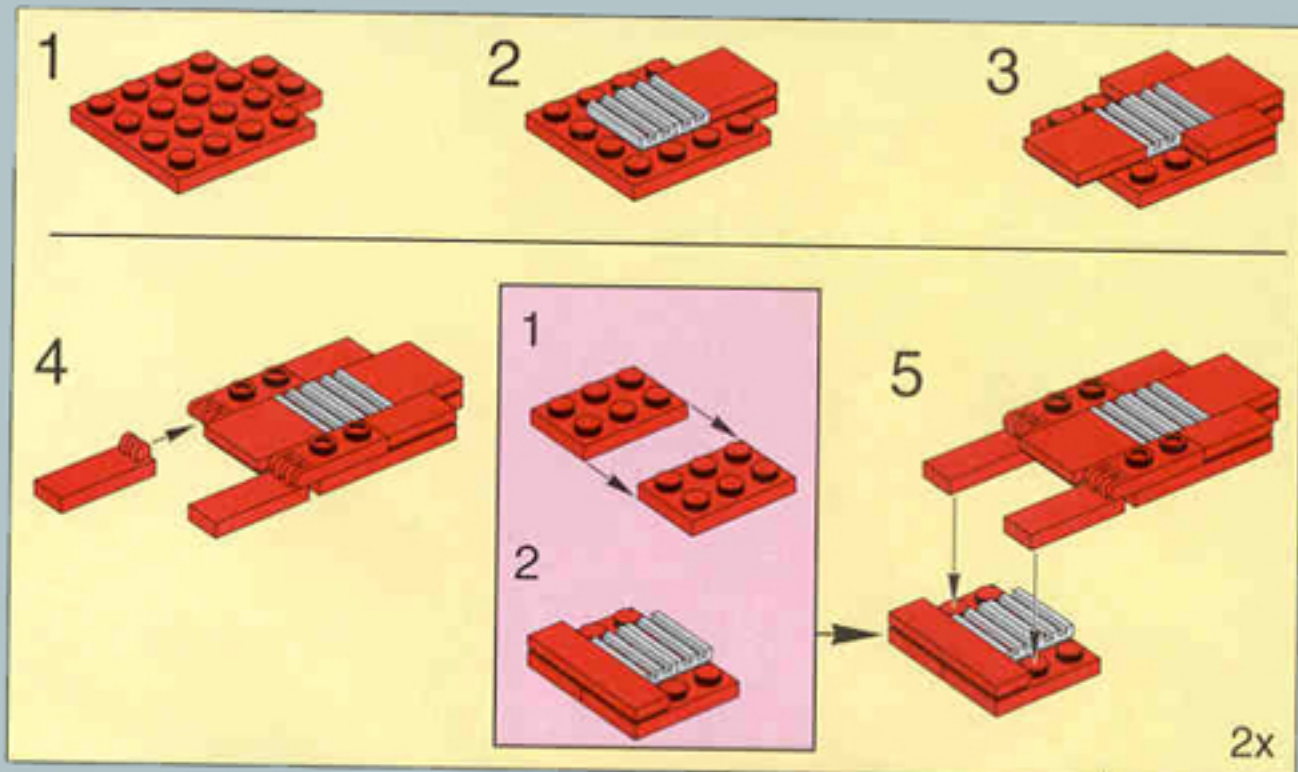

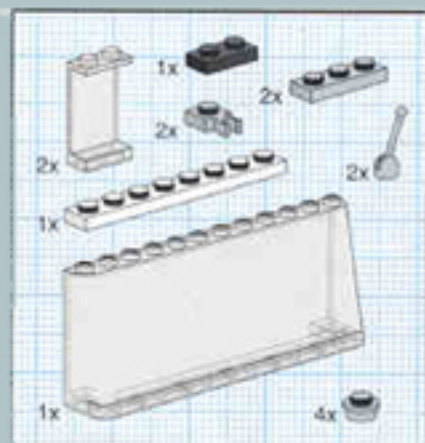

43

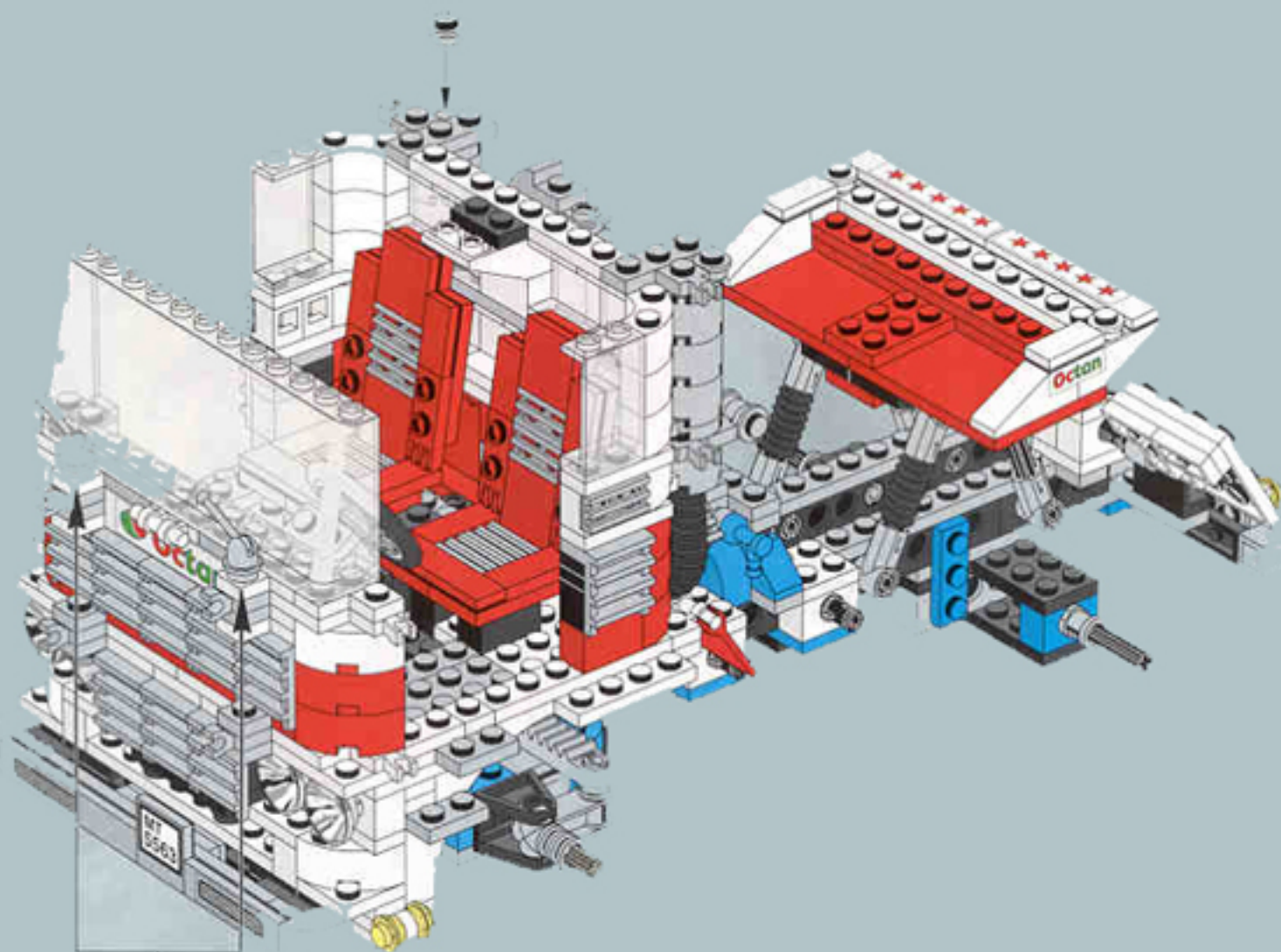



44

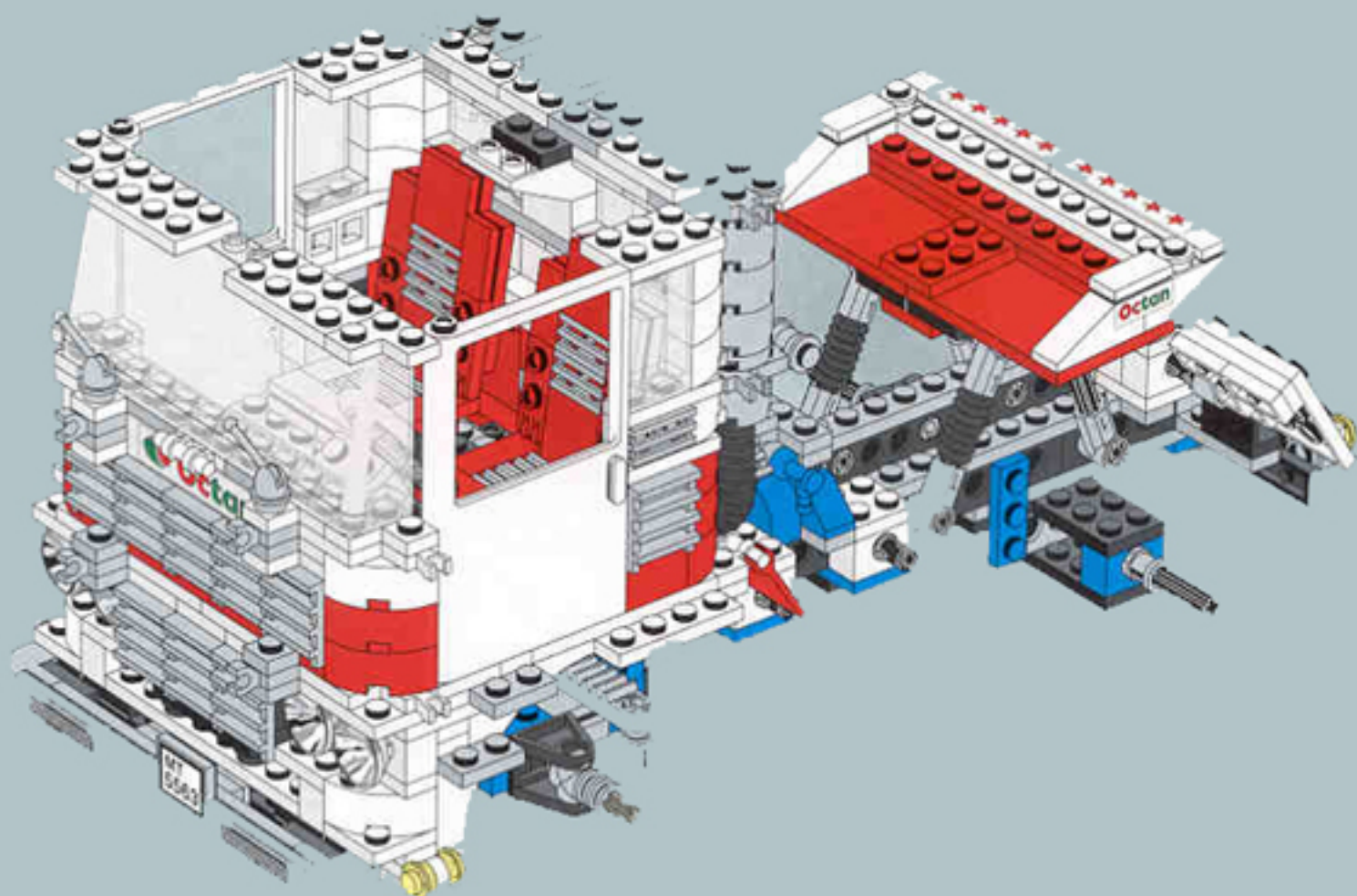

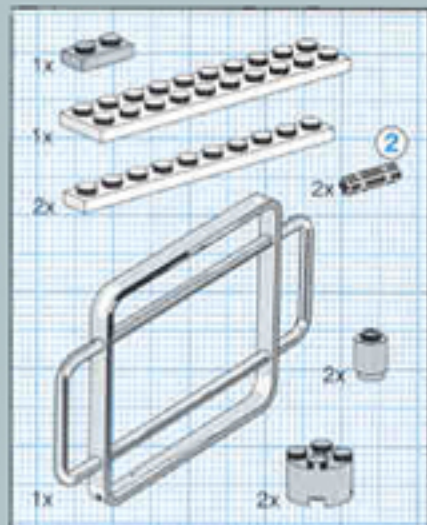

45

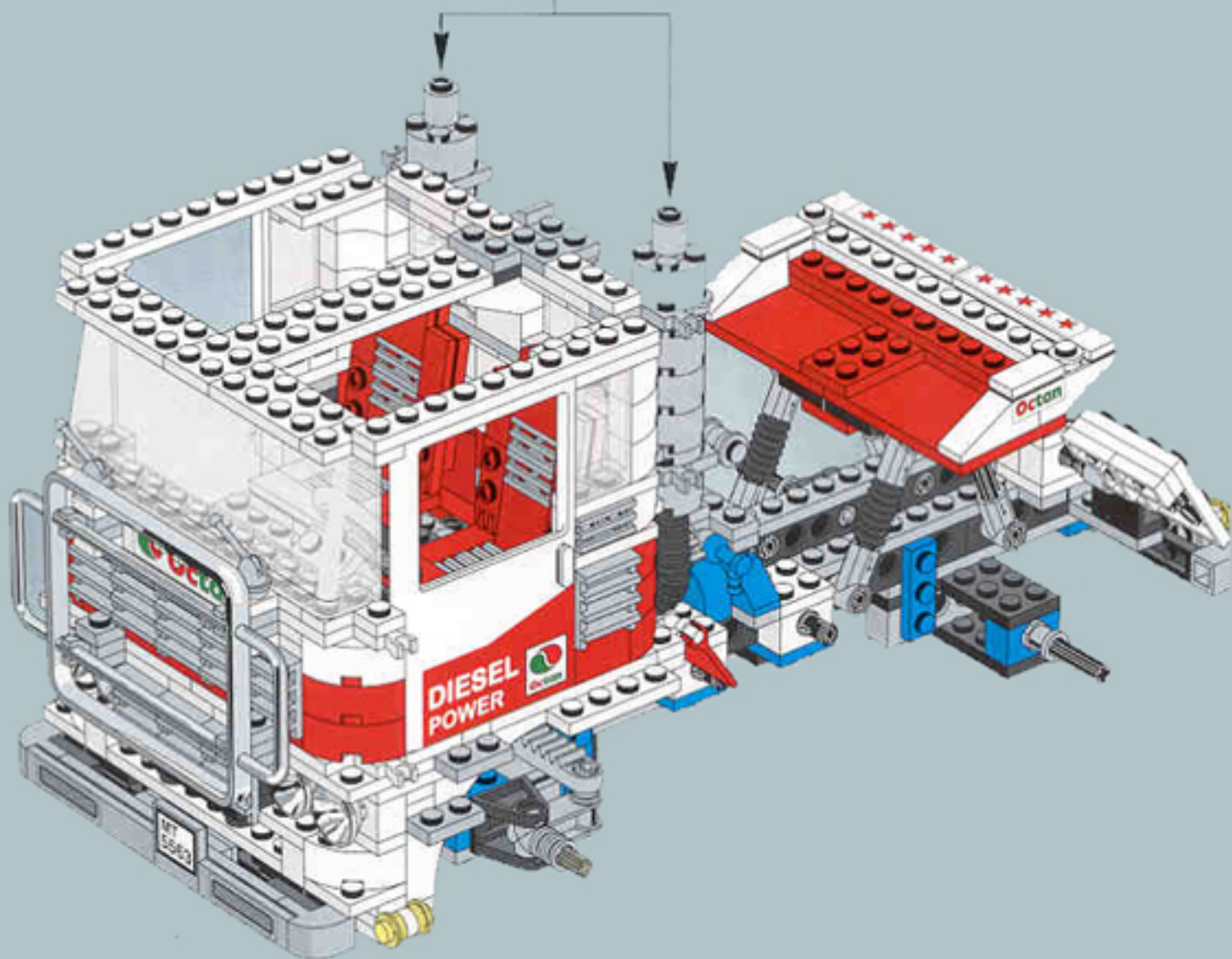

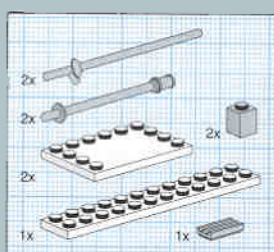

46

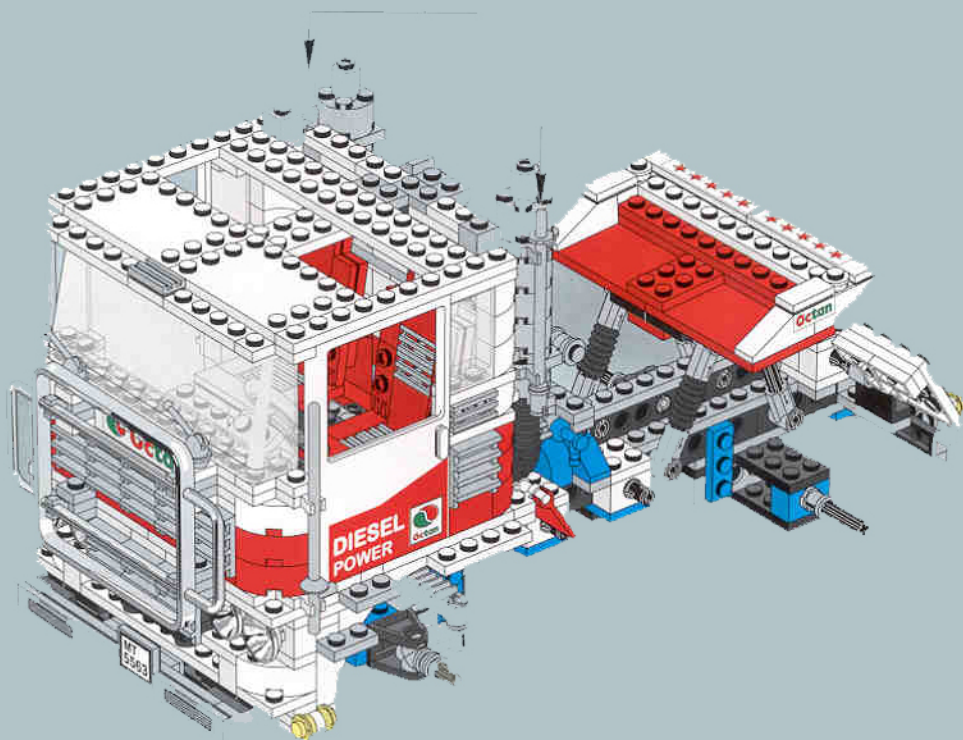



# 47

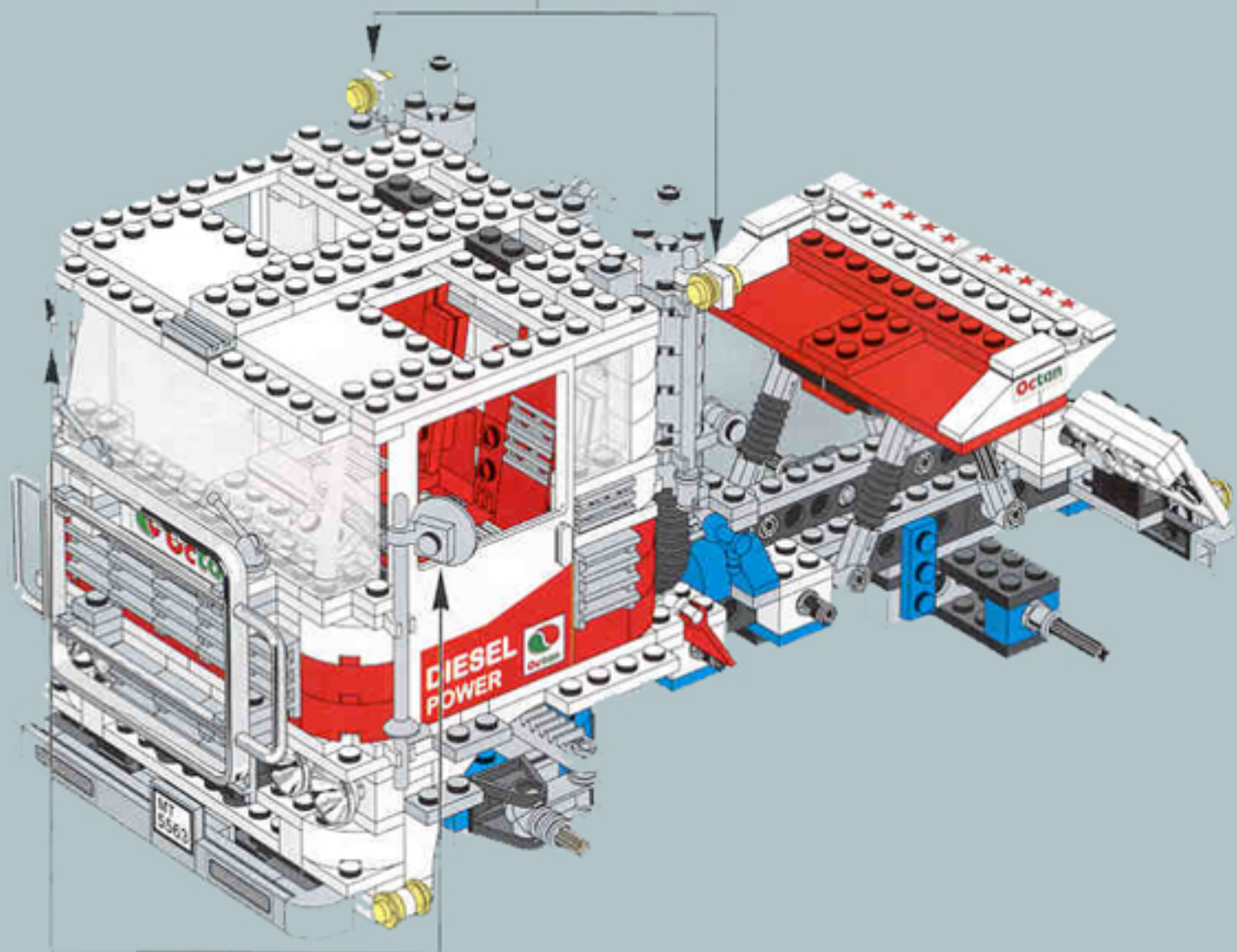
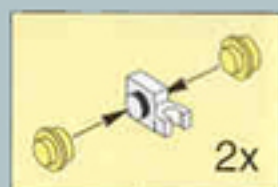





48

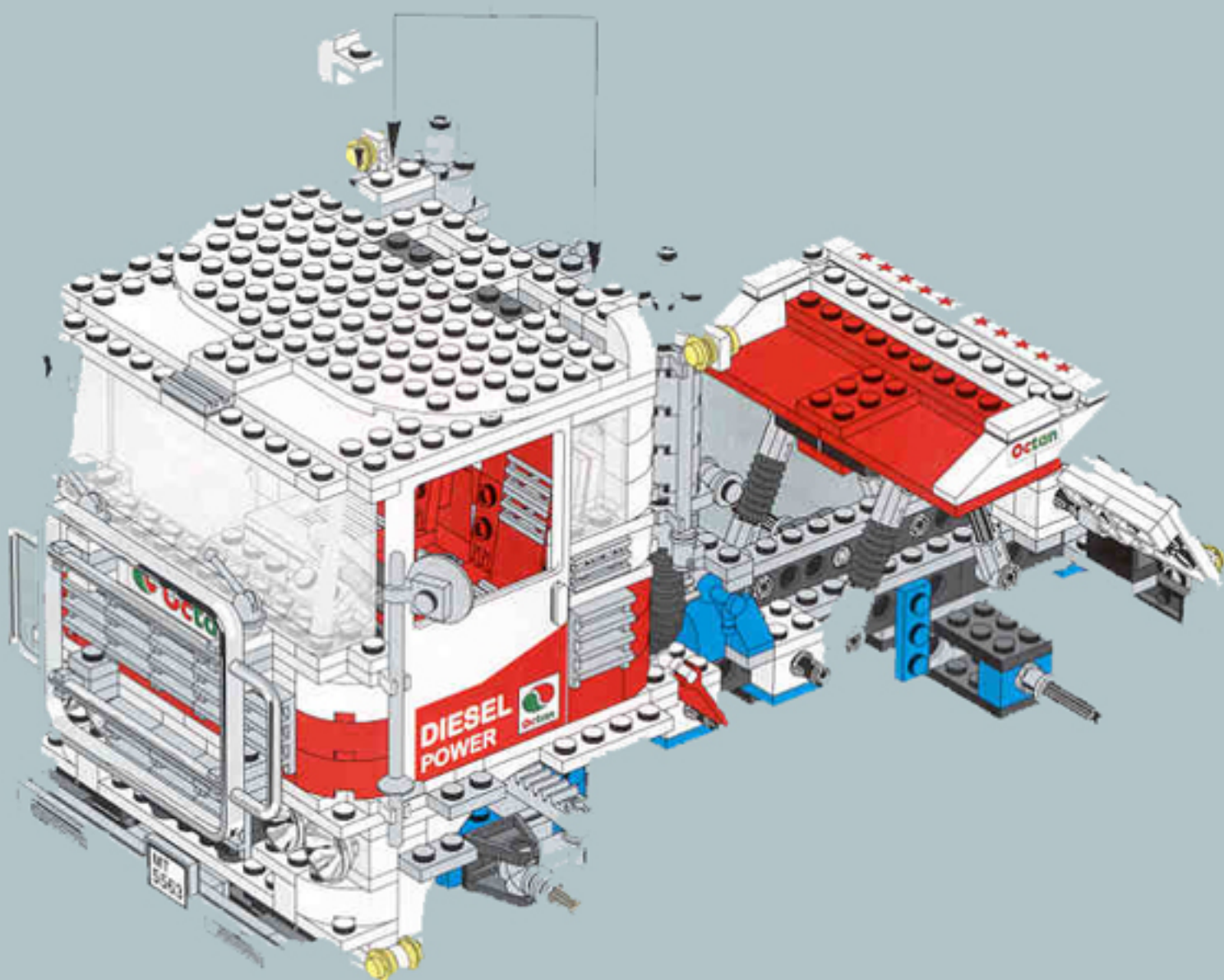
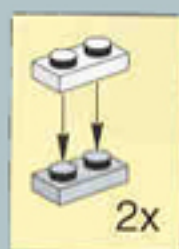

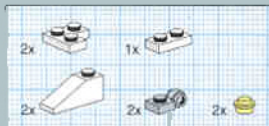

49

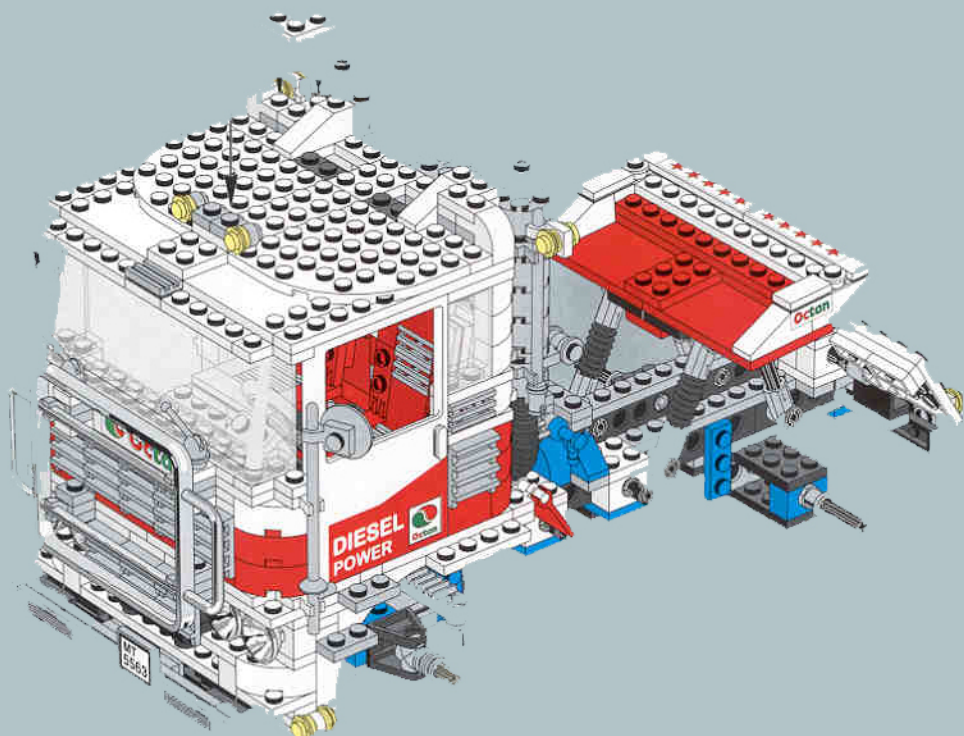
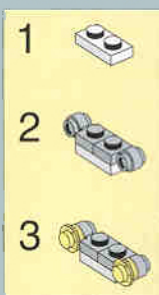

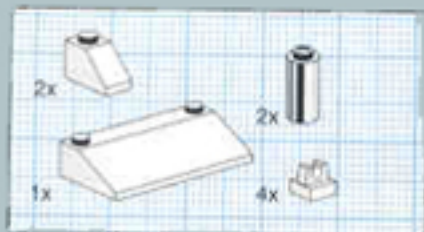

50

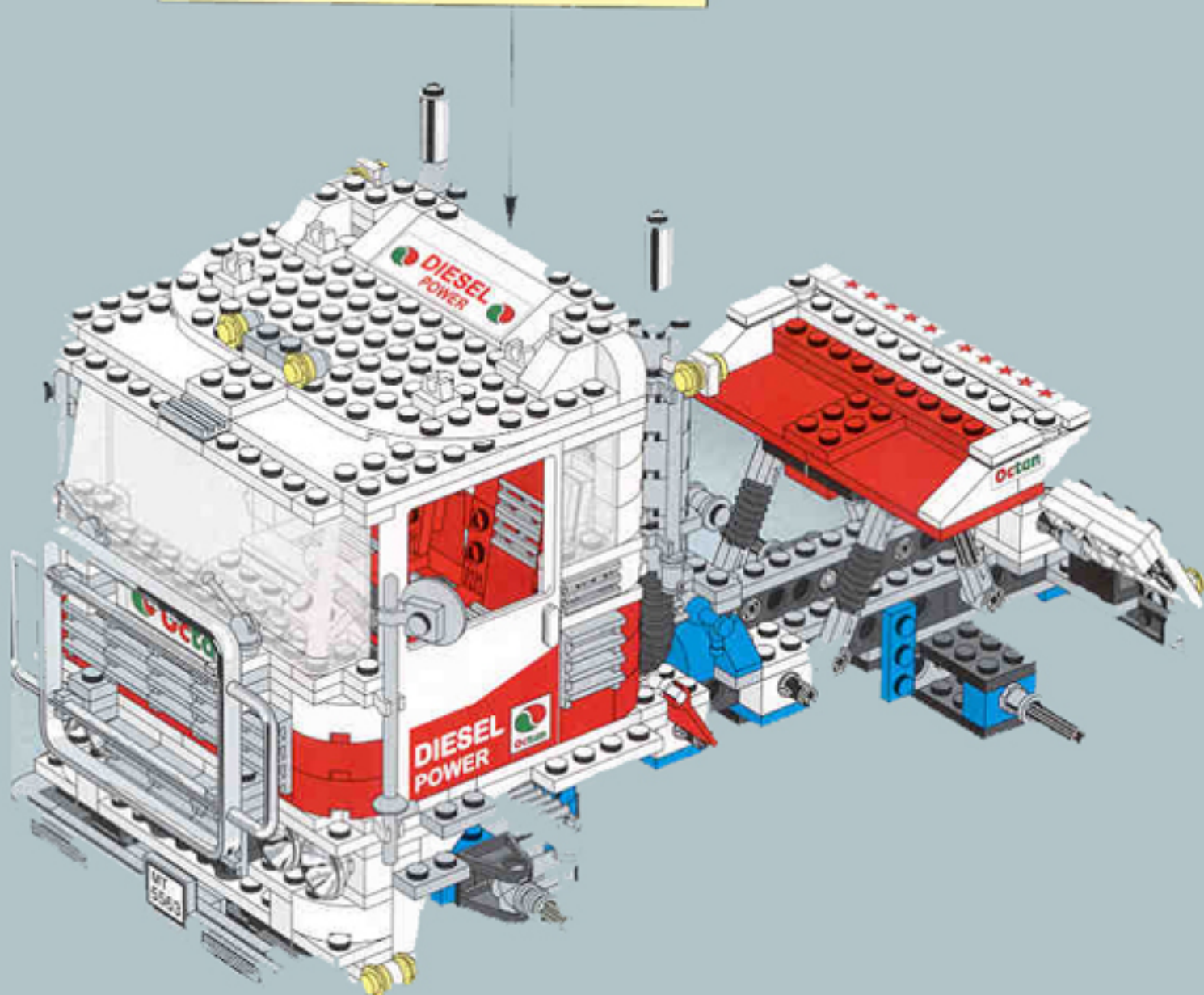
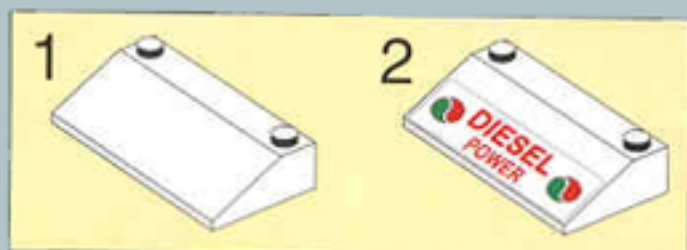

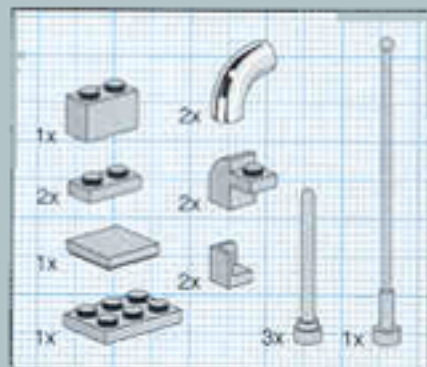

51

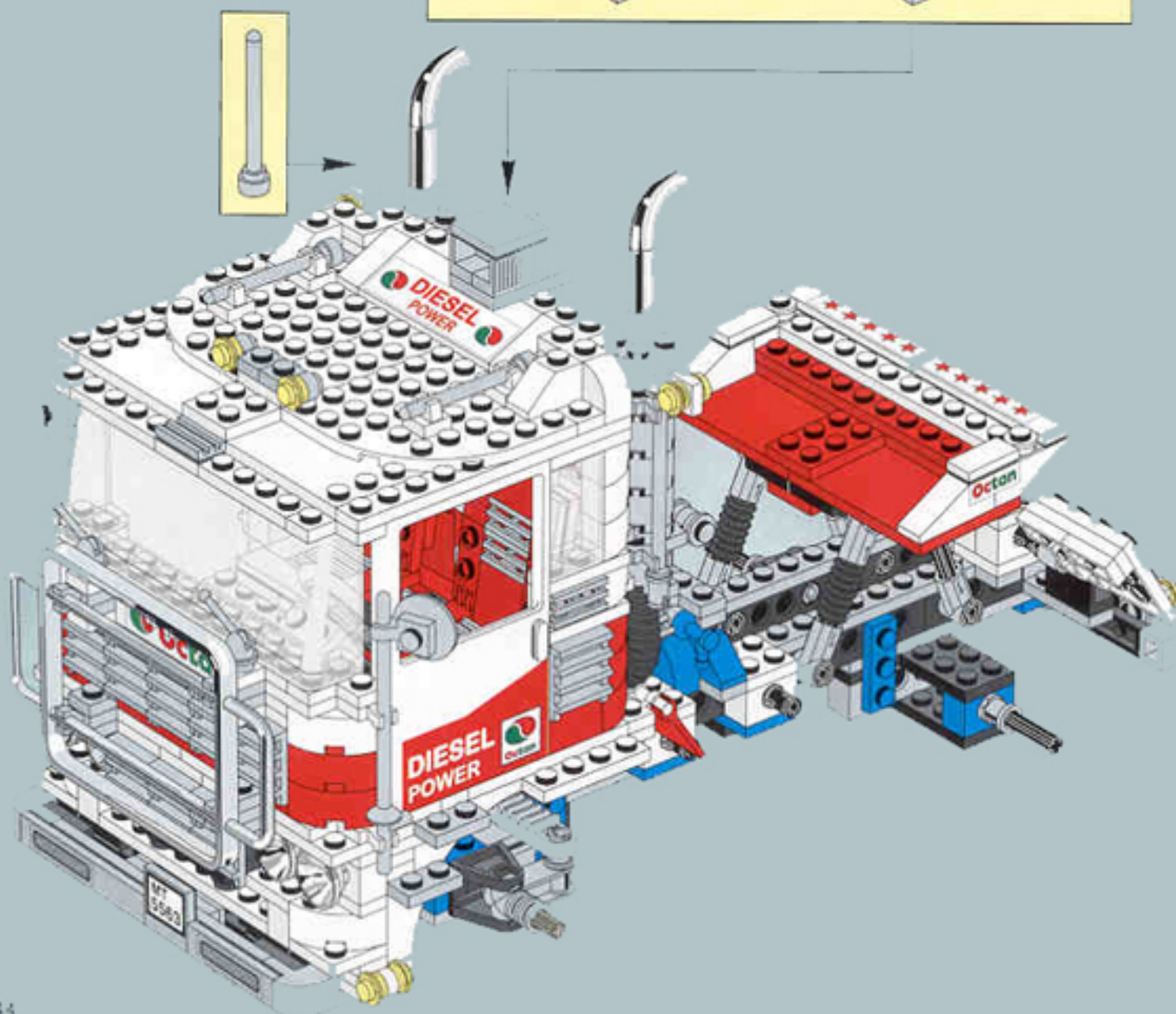
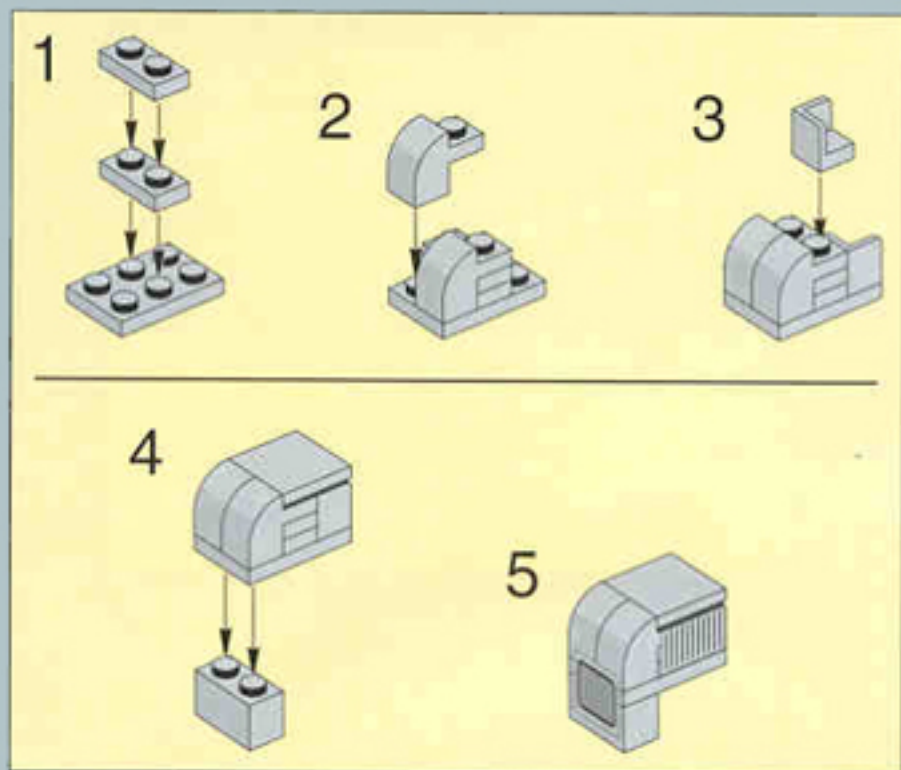



52

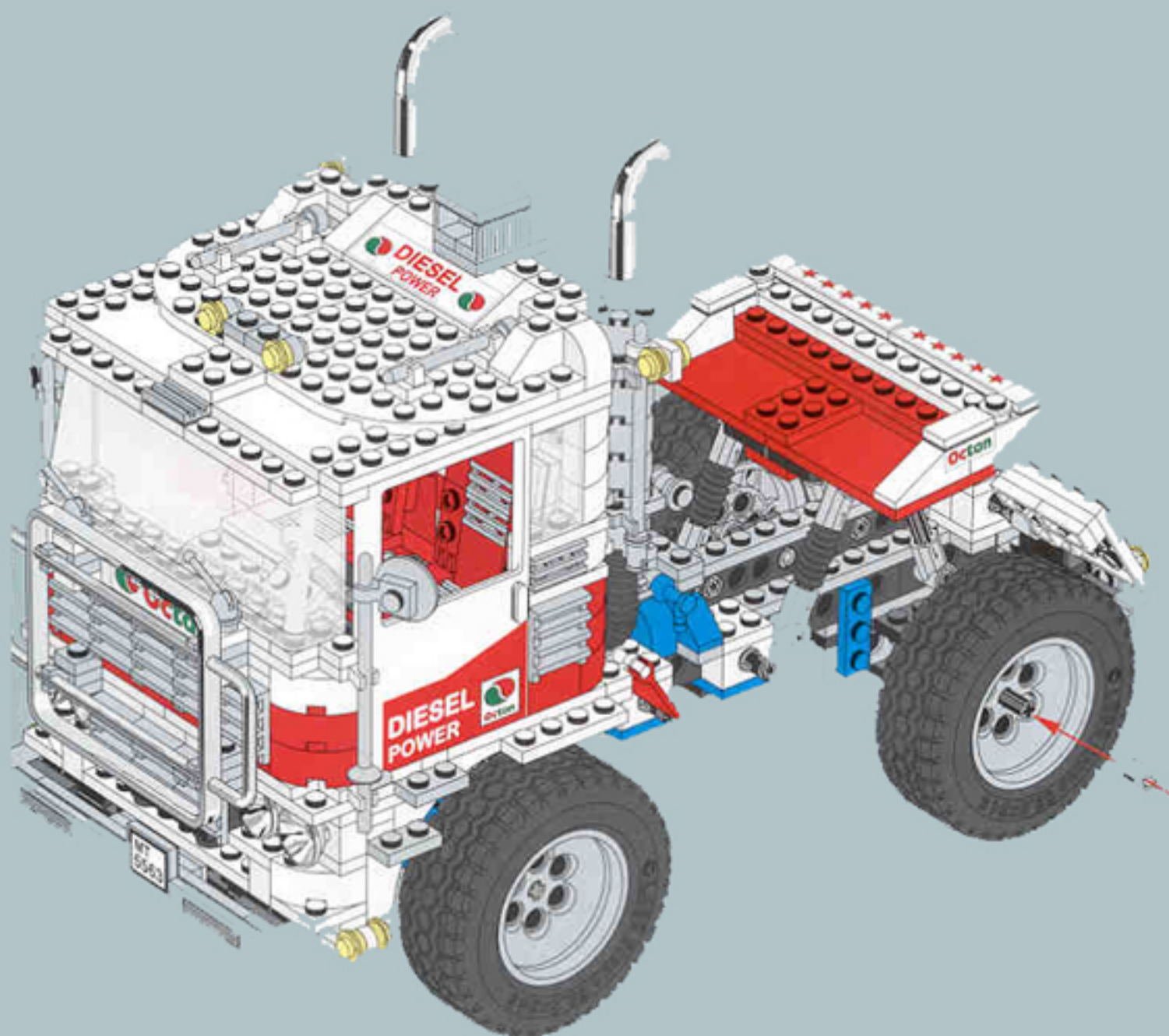

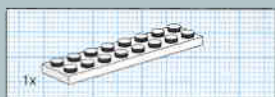
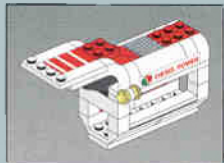

1

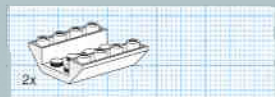
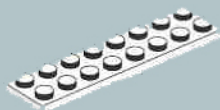

2

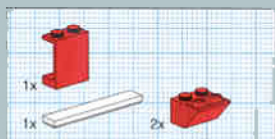
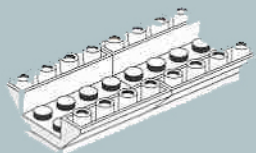

3

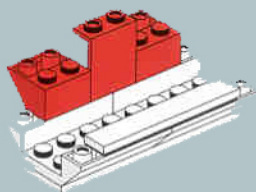

4

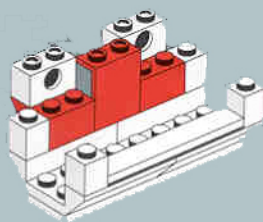

5

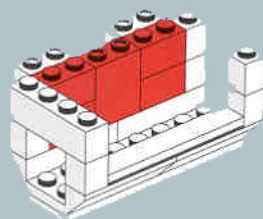

6

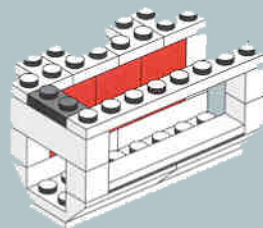



7

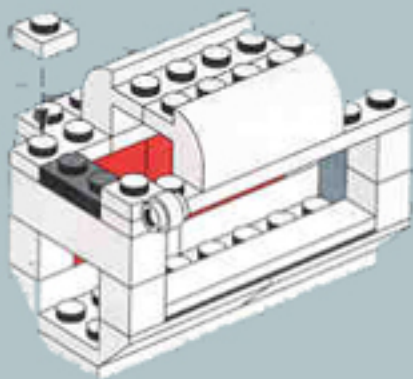

8

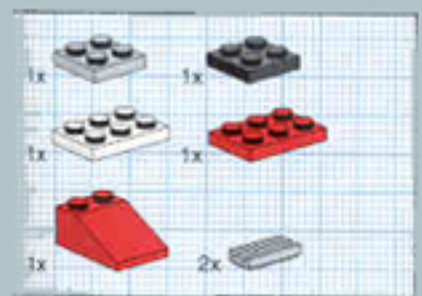
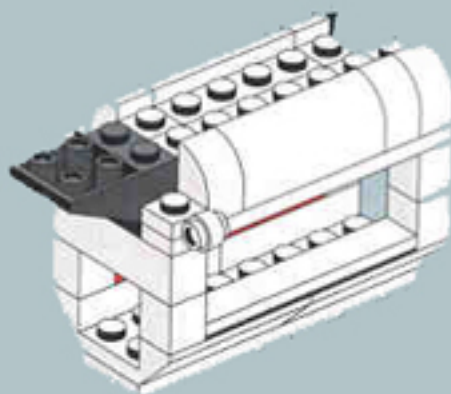

9

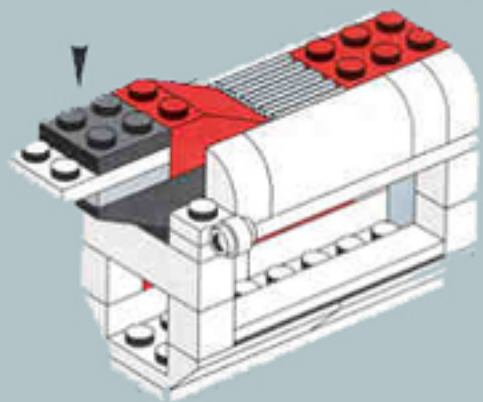
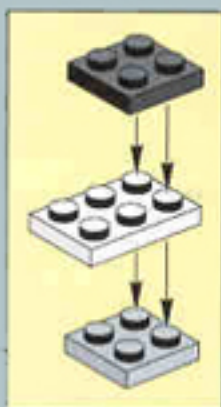

10

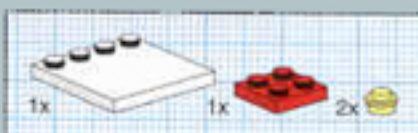
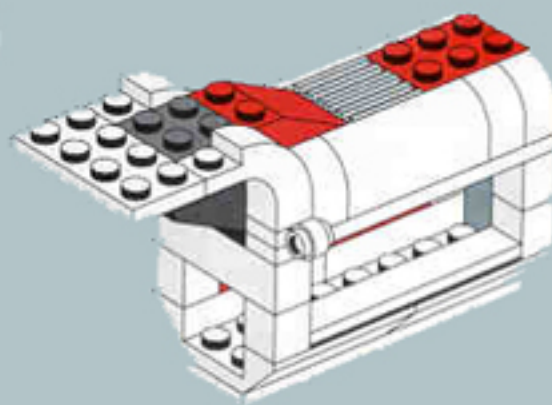

11

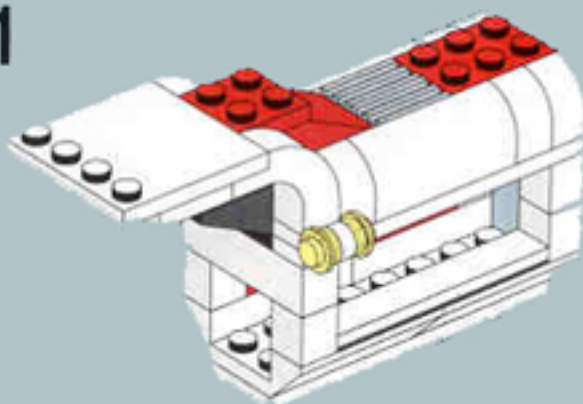

12

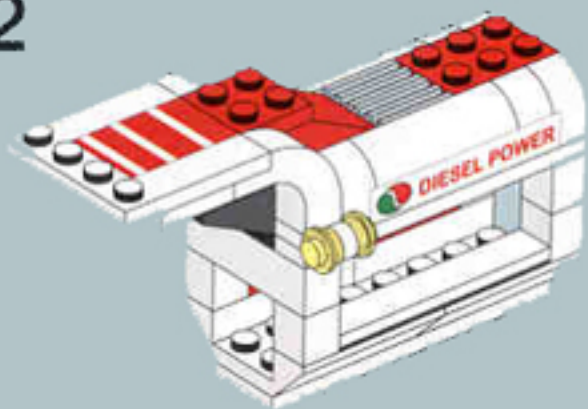

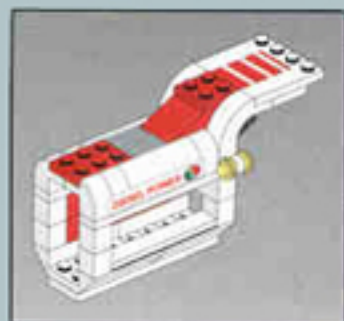

1



2

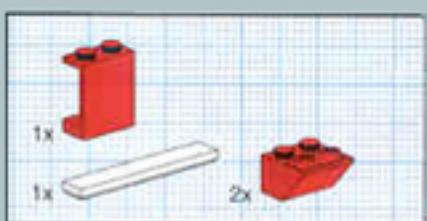
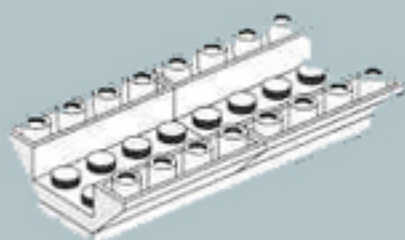

3

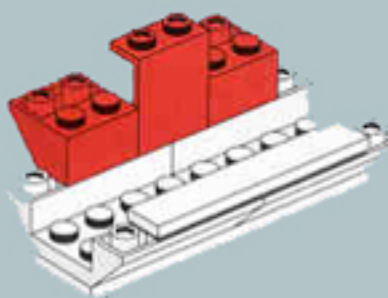

4

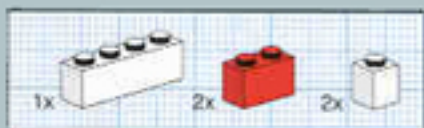
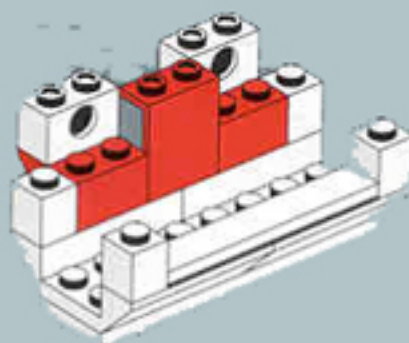

5

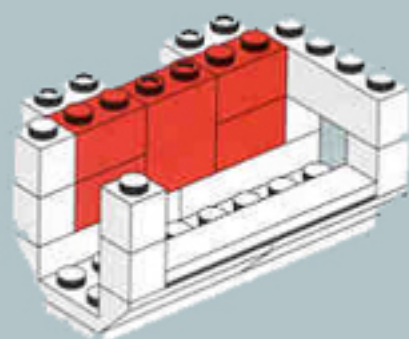

6

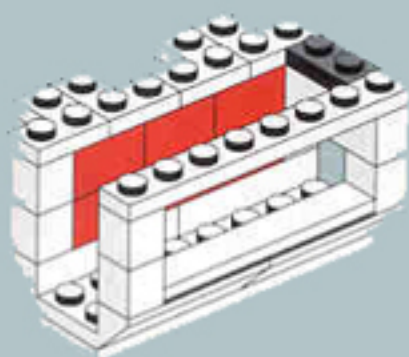





7

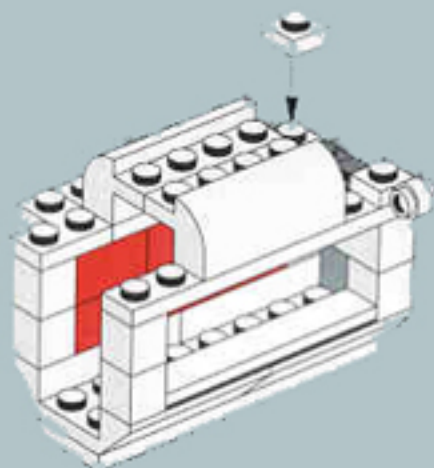

8

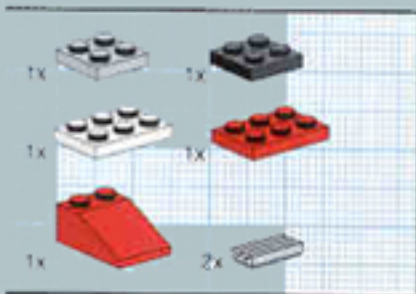
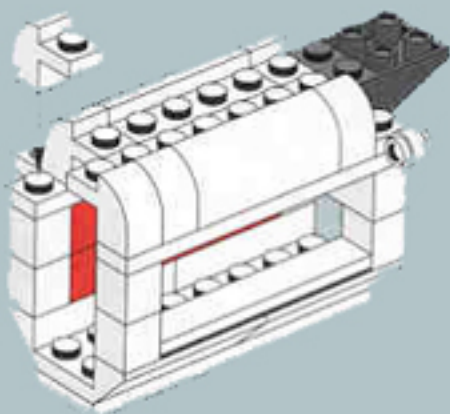

9

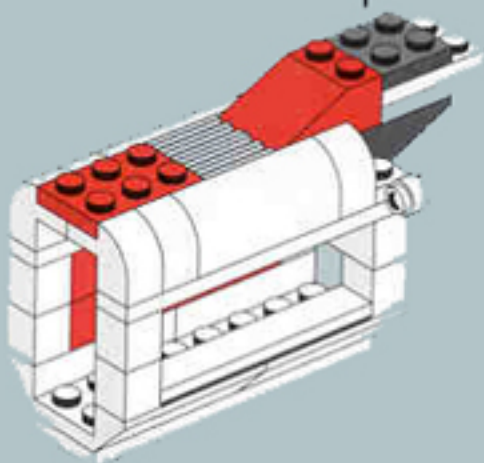

10

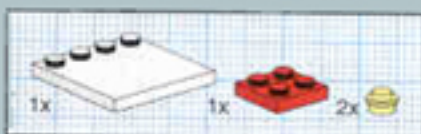
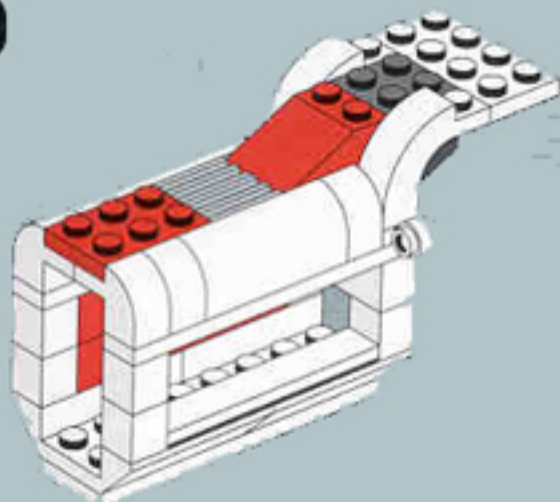

11

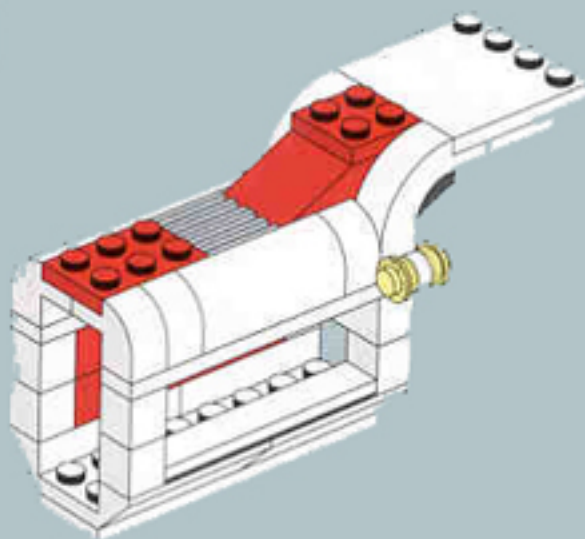

12

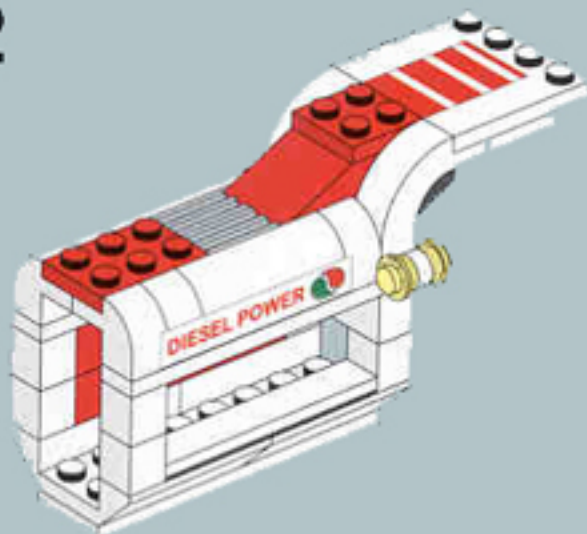

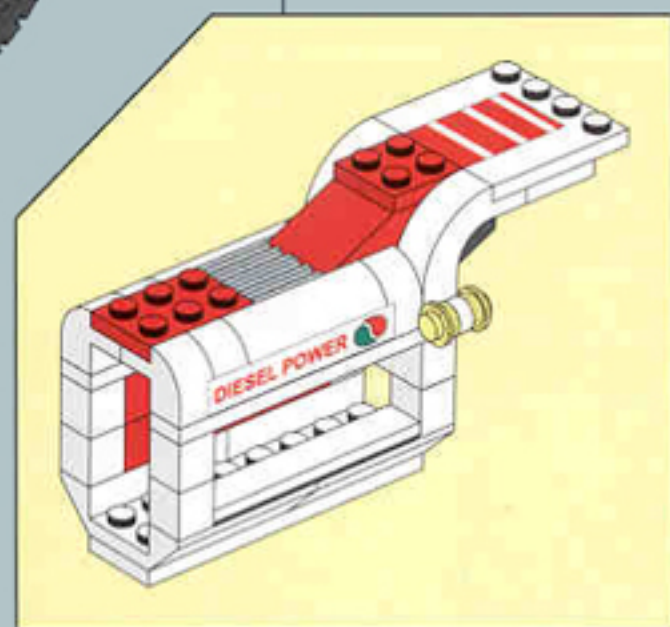
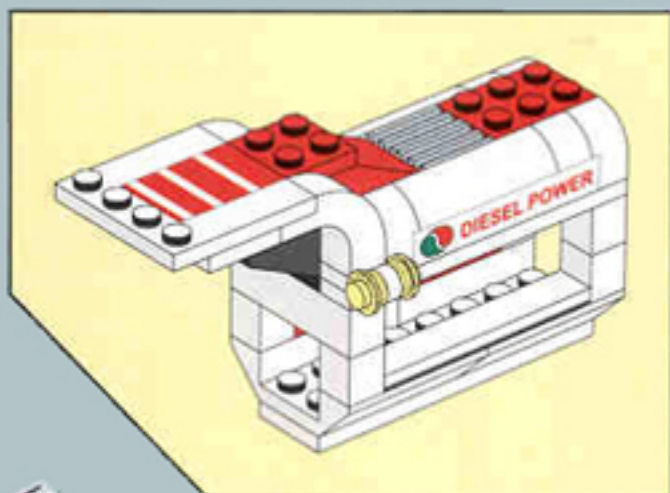
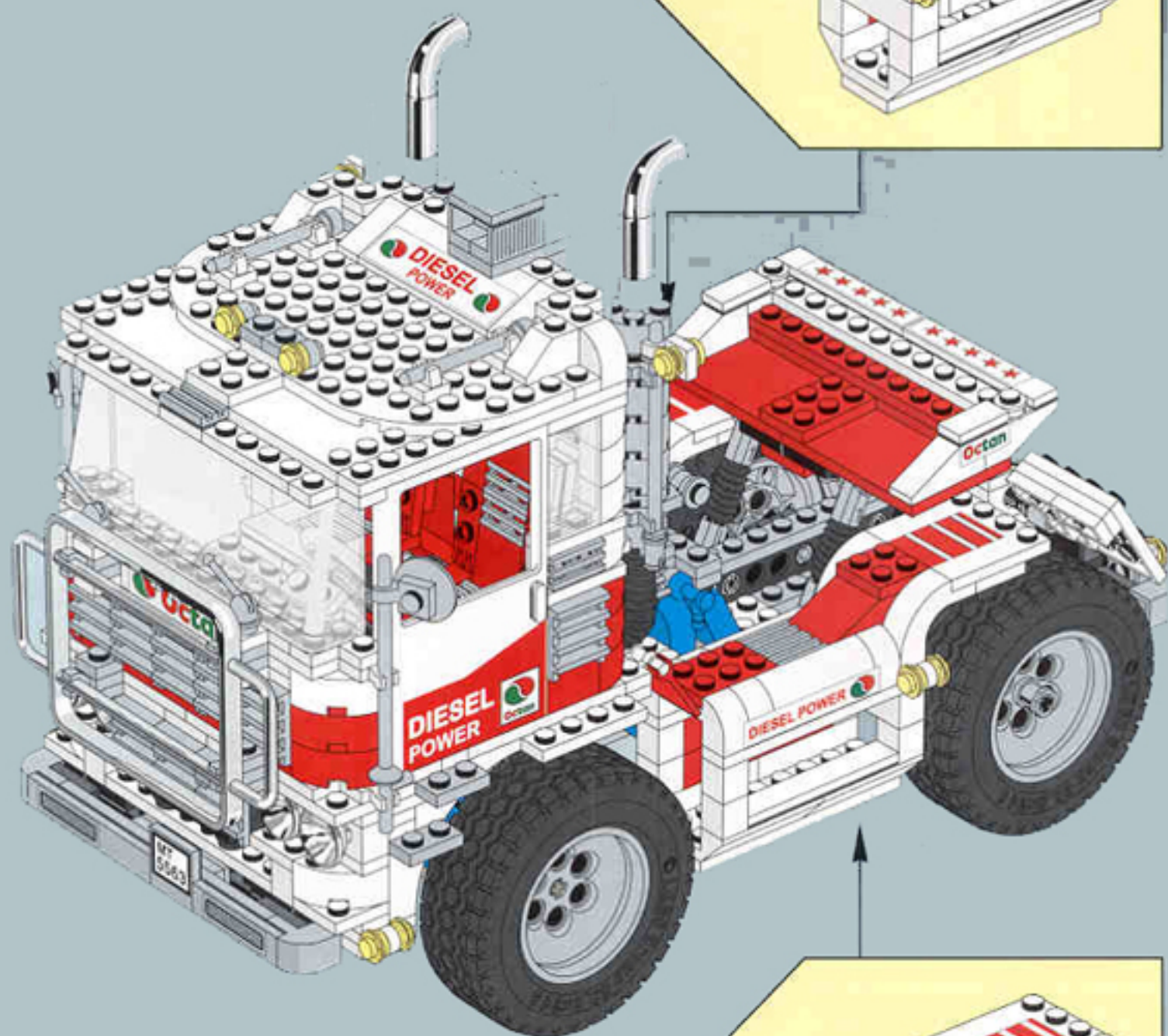



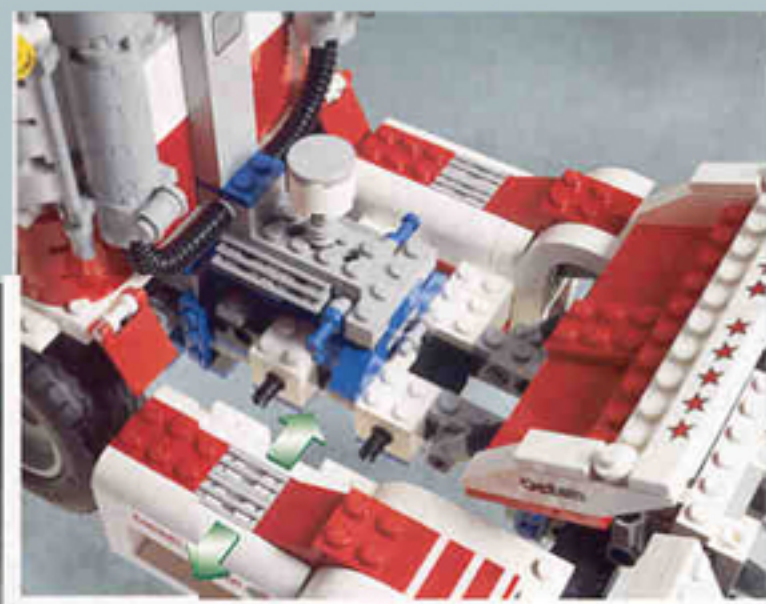
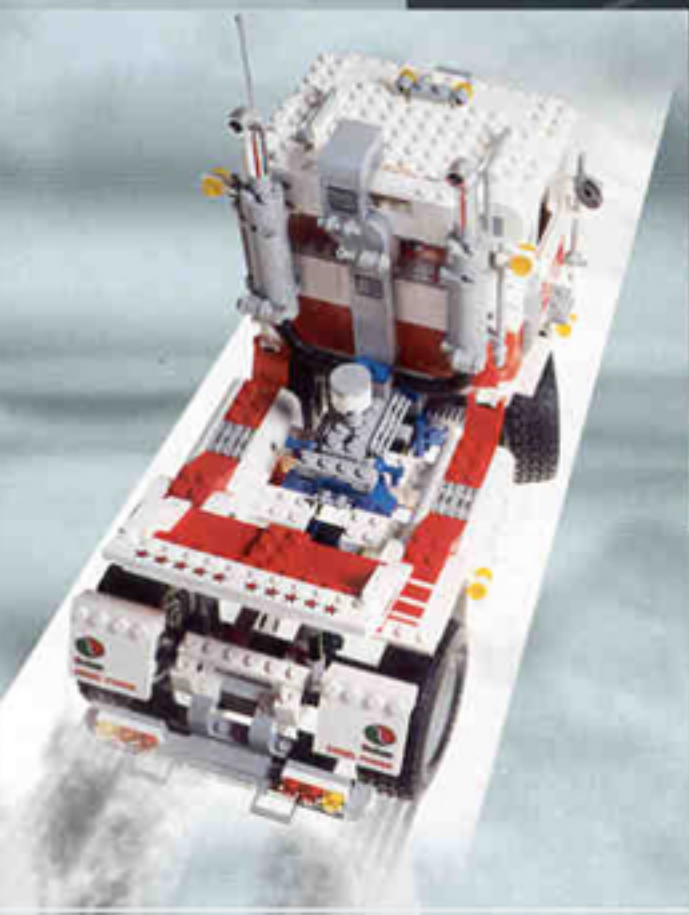







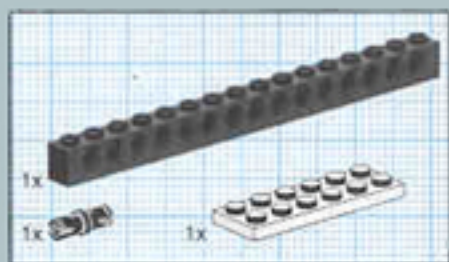

1

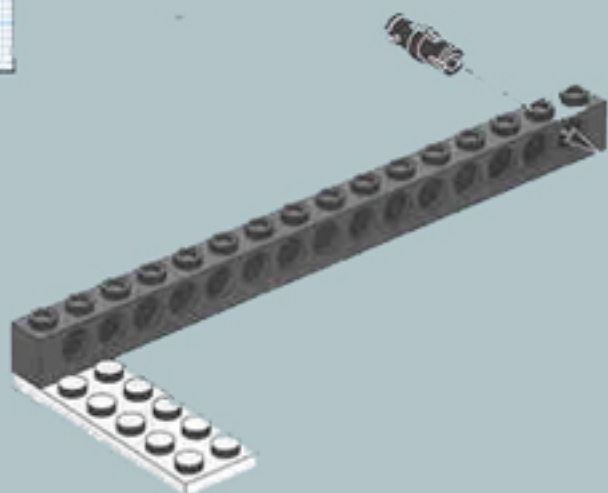

2

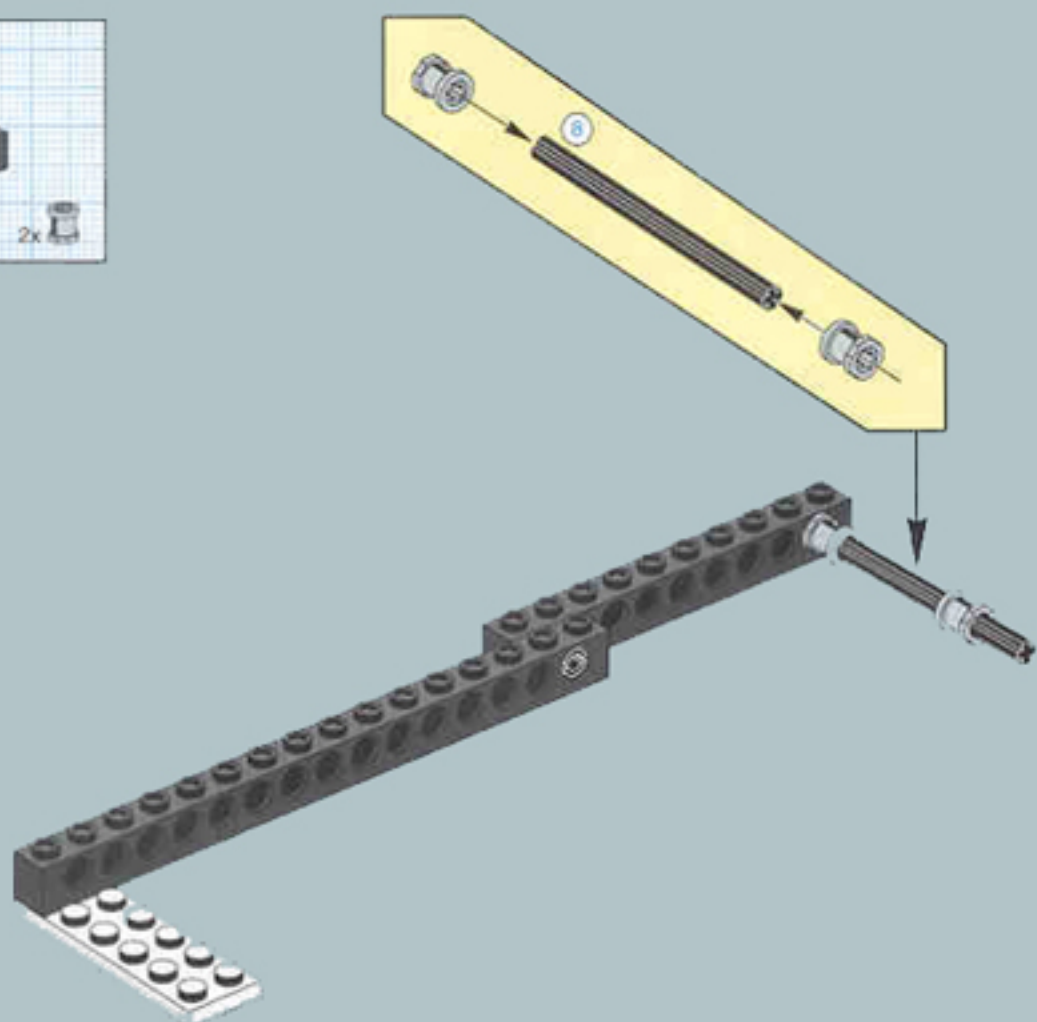







5

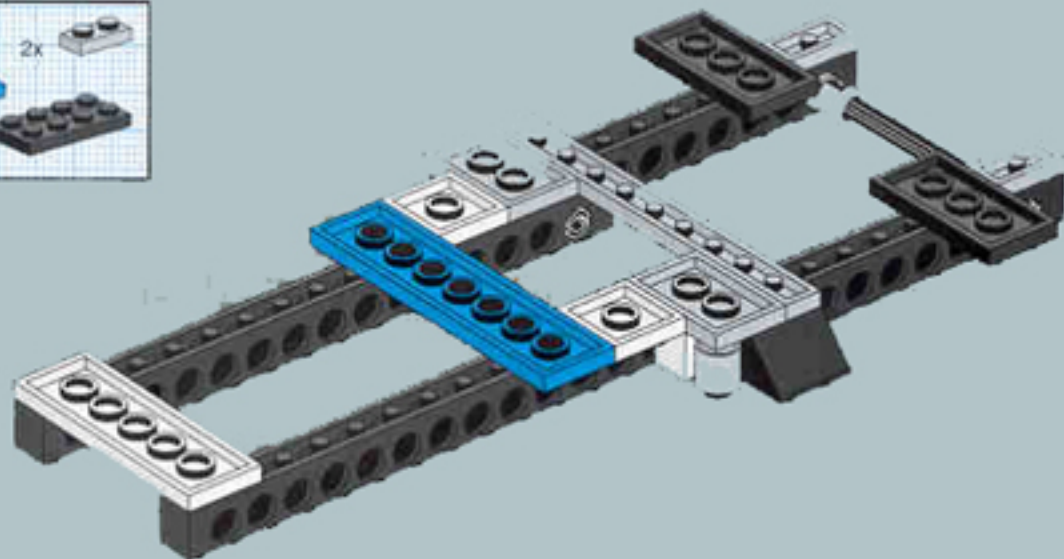

6

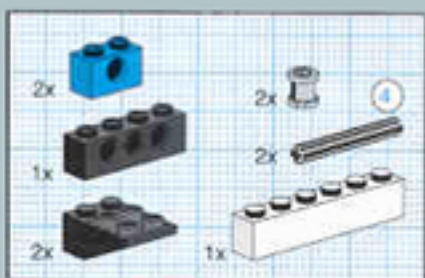
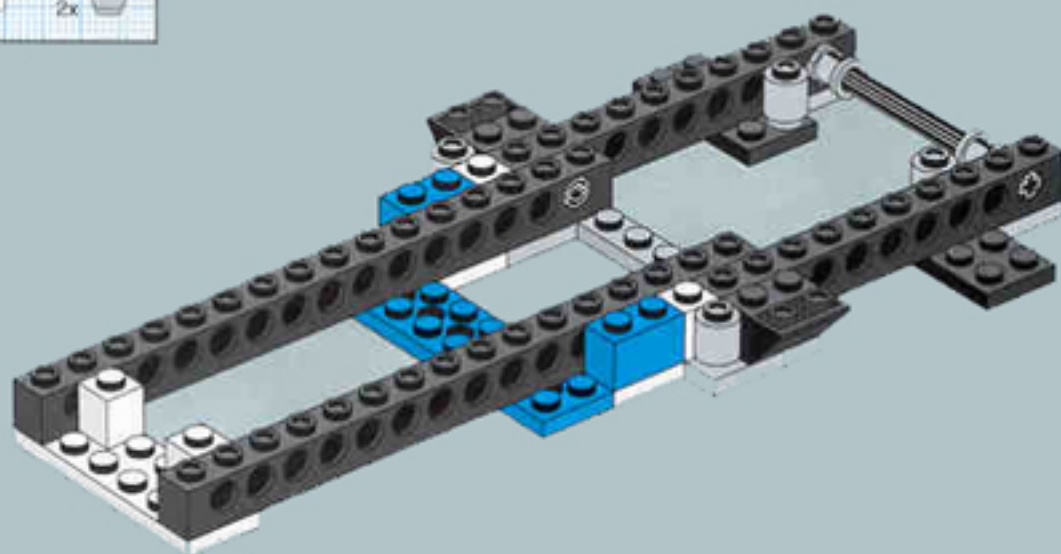

7

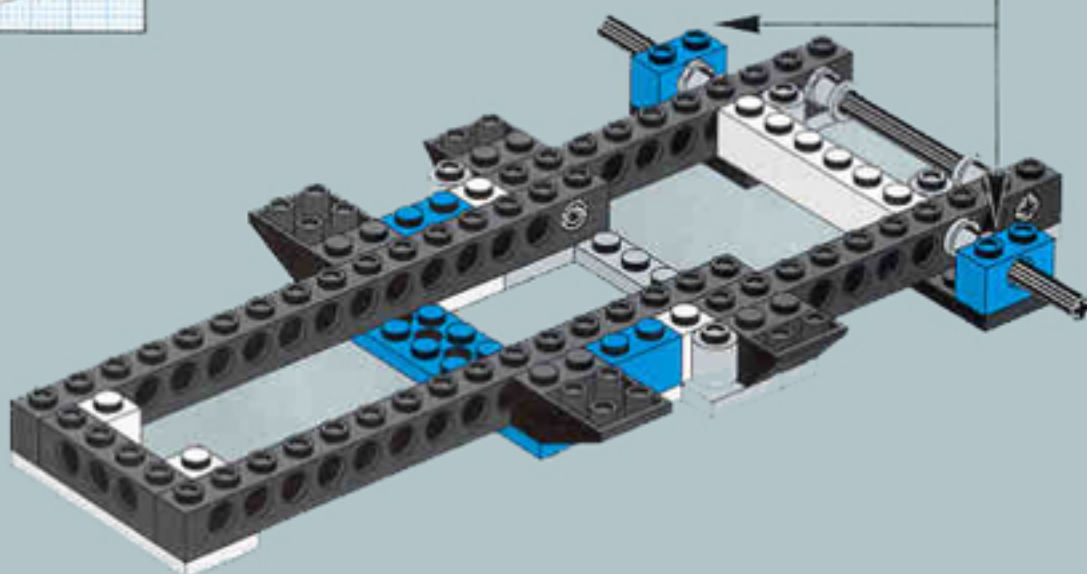
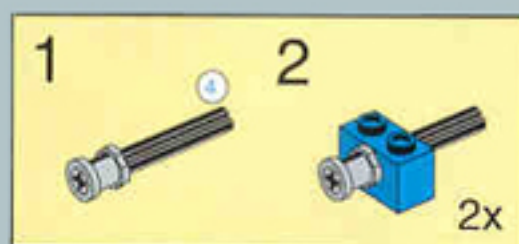



8

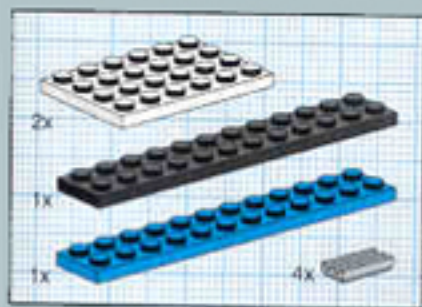
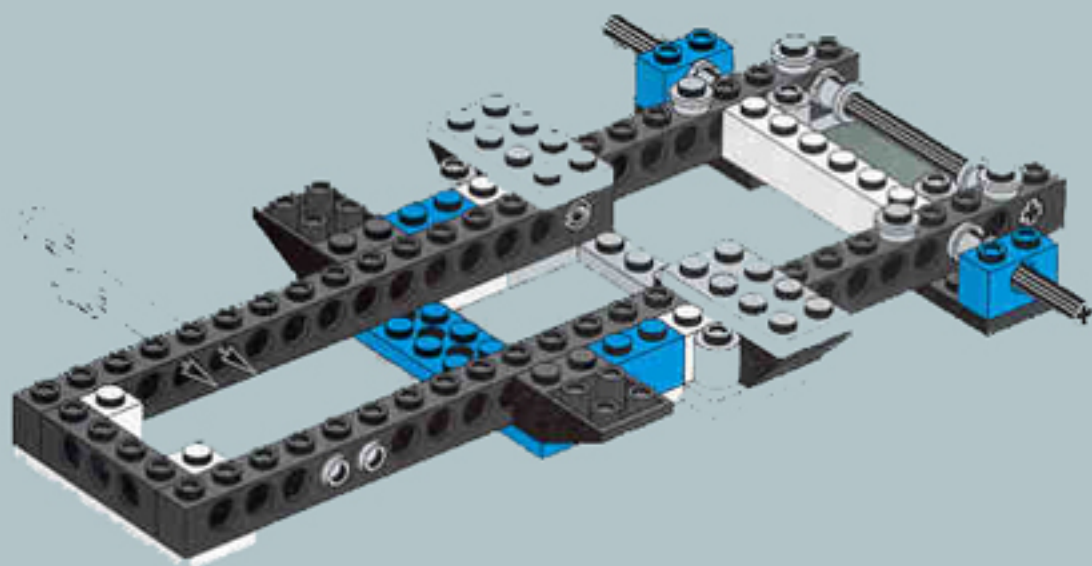

9

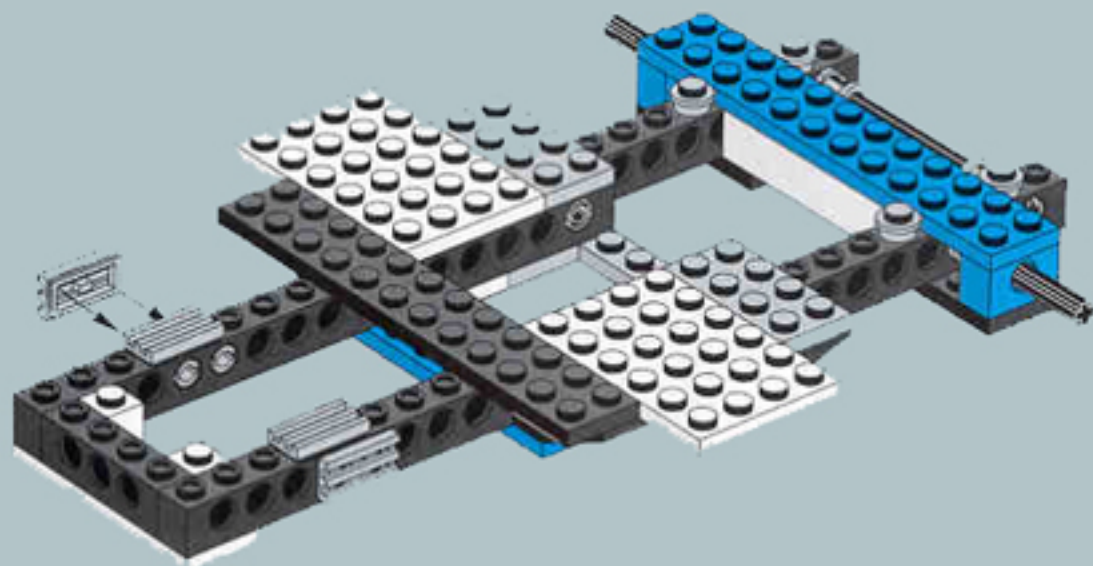

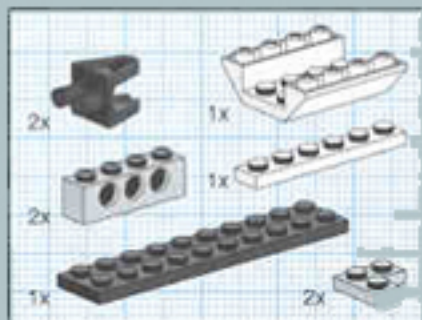

10

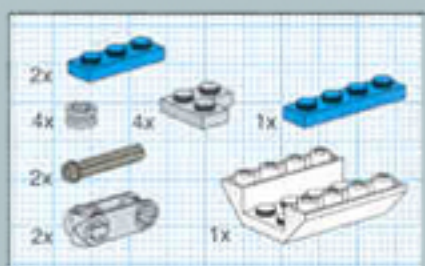
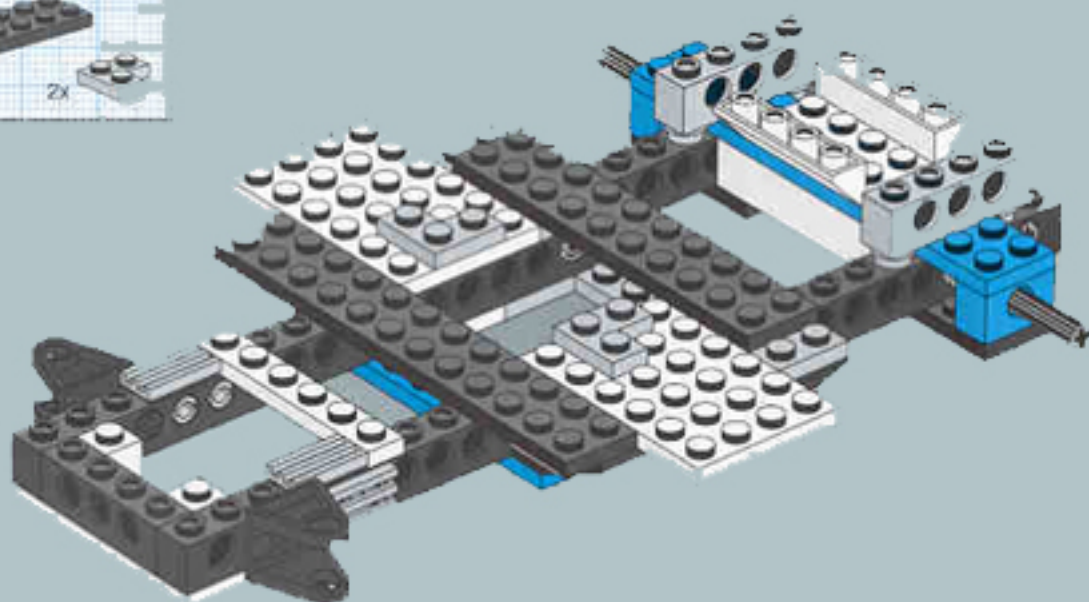

11

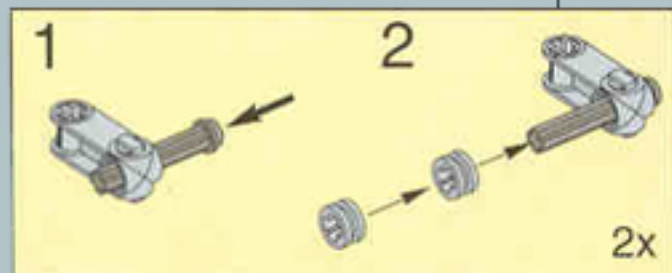
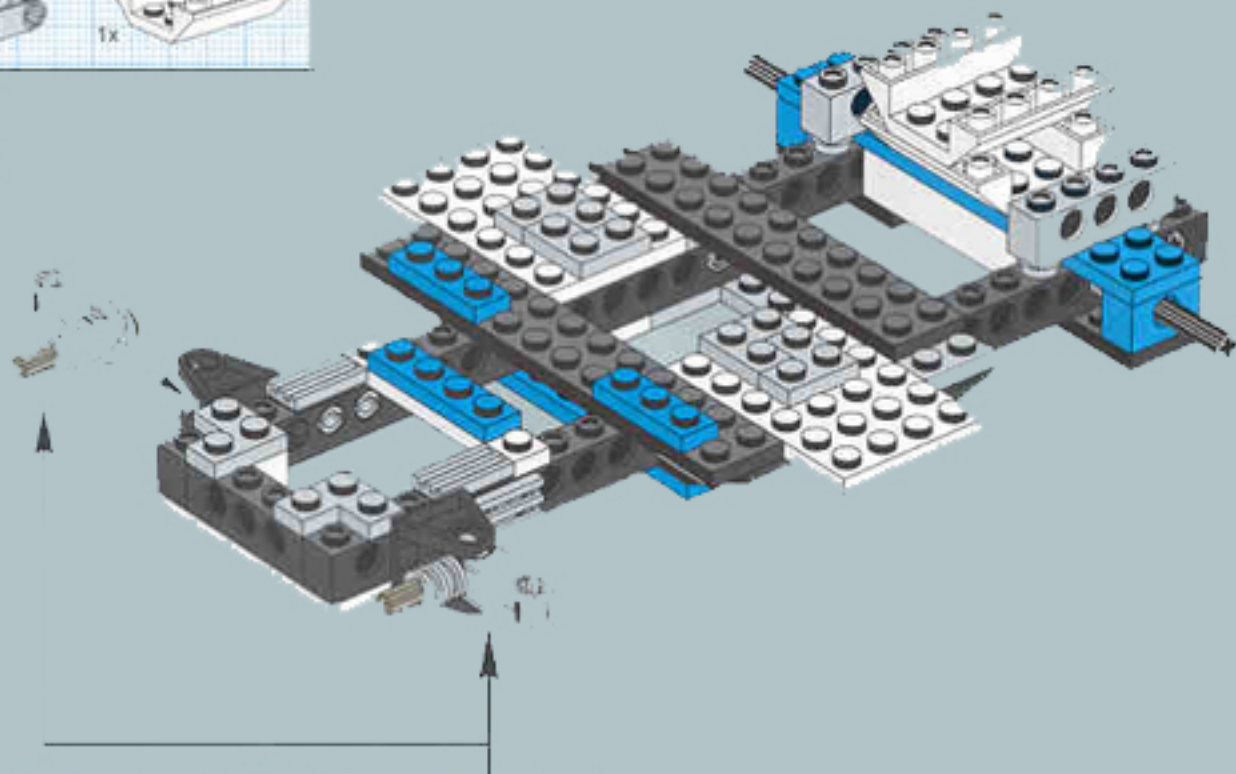

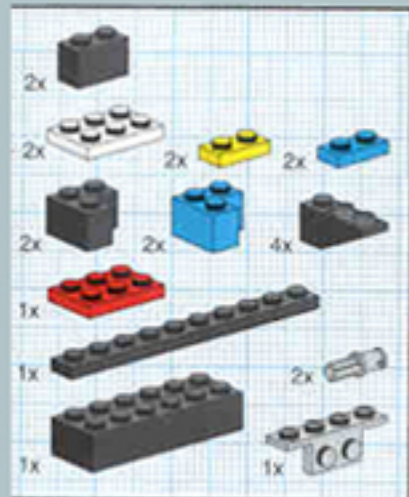

12

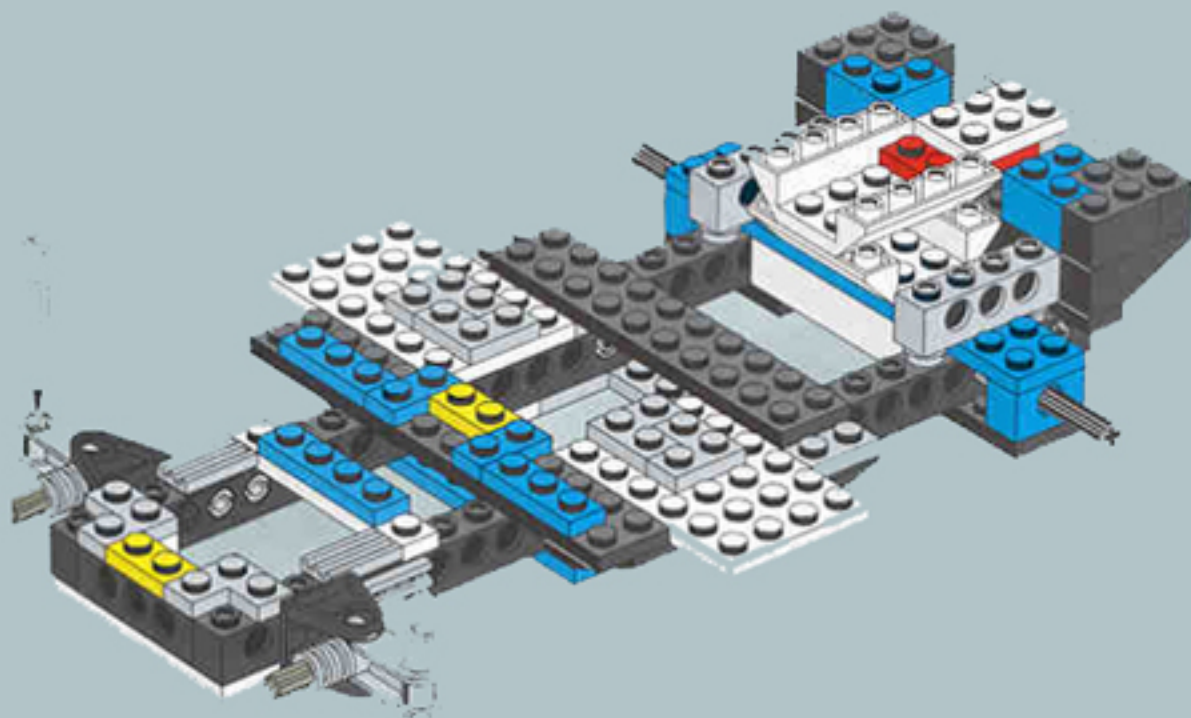
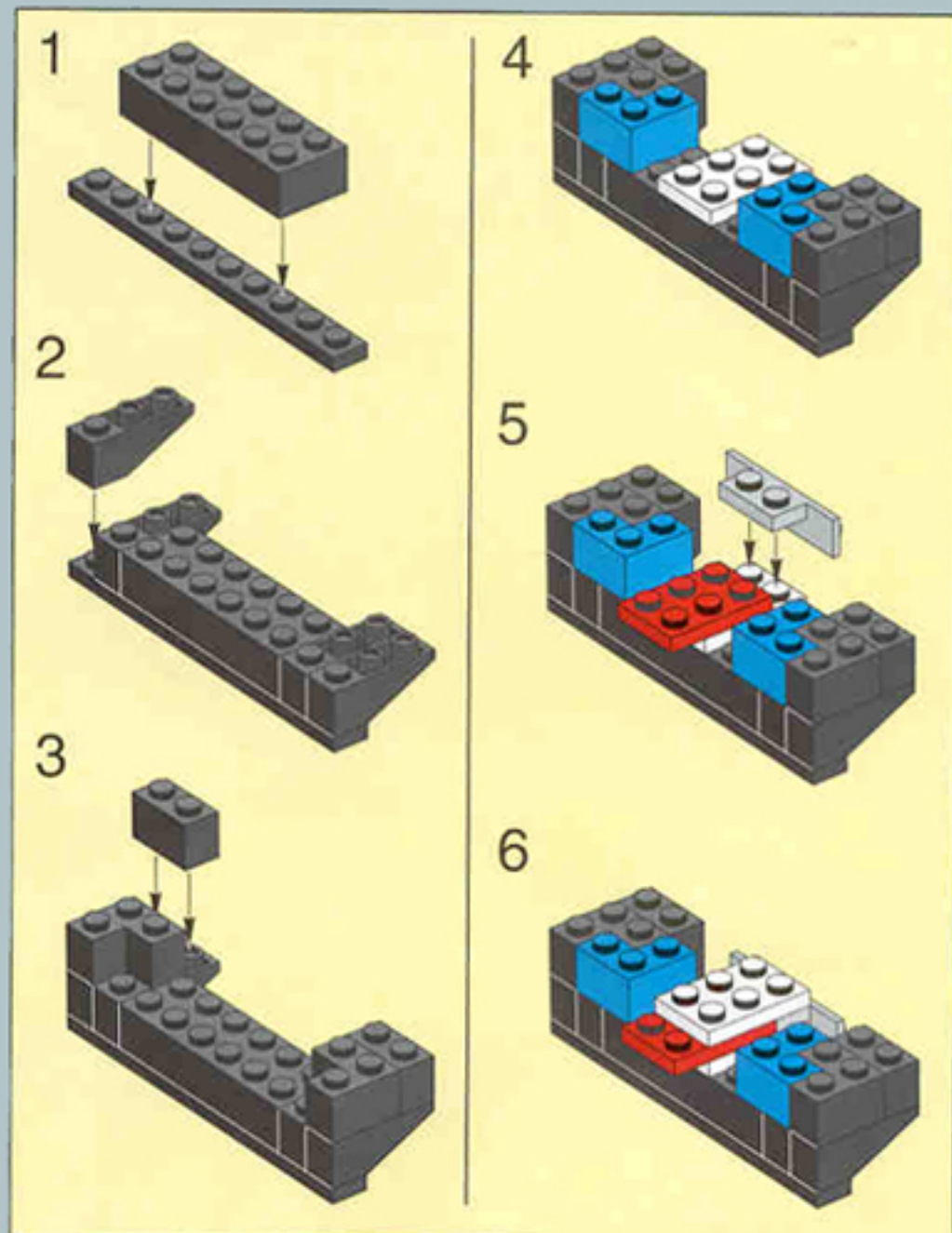

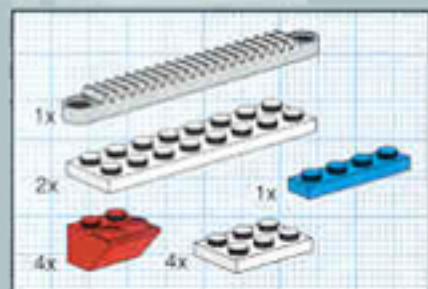

# 13

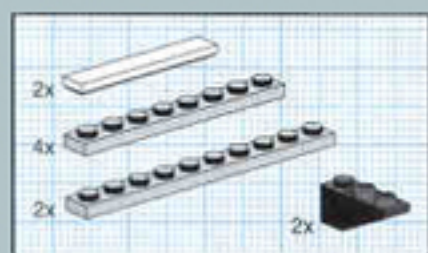
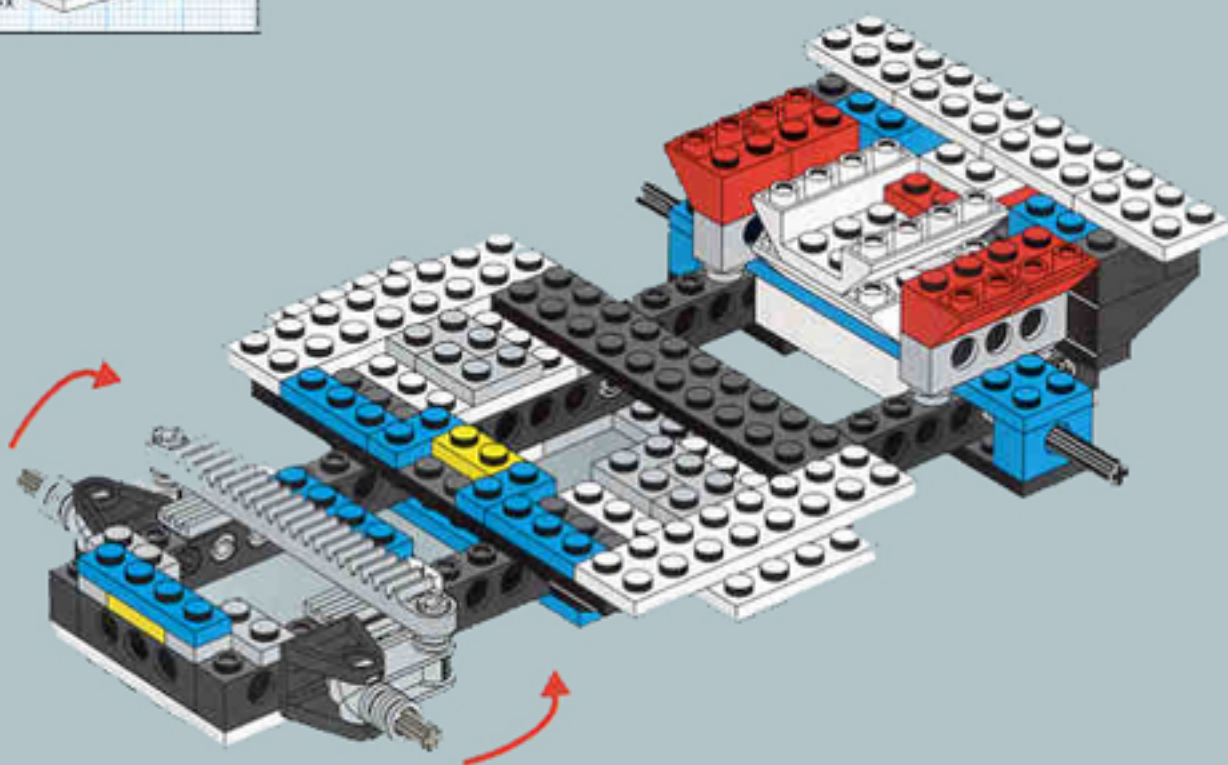

# 14

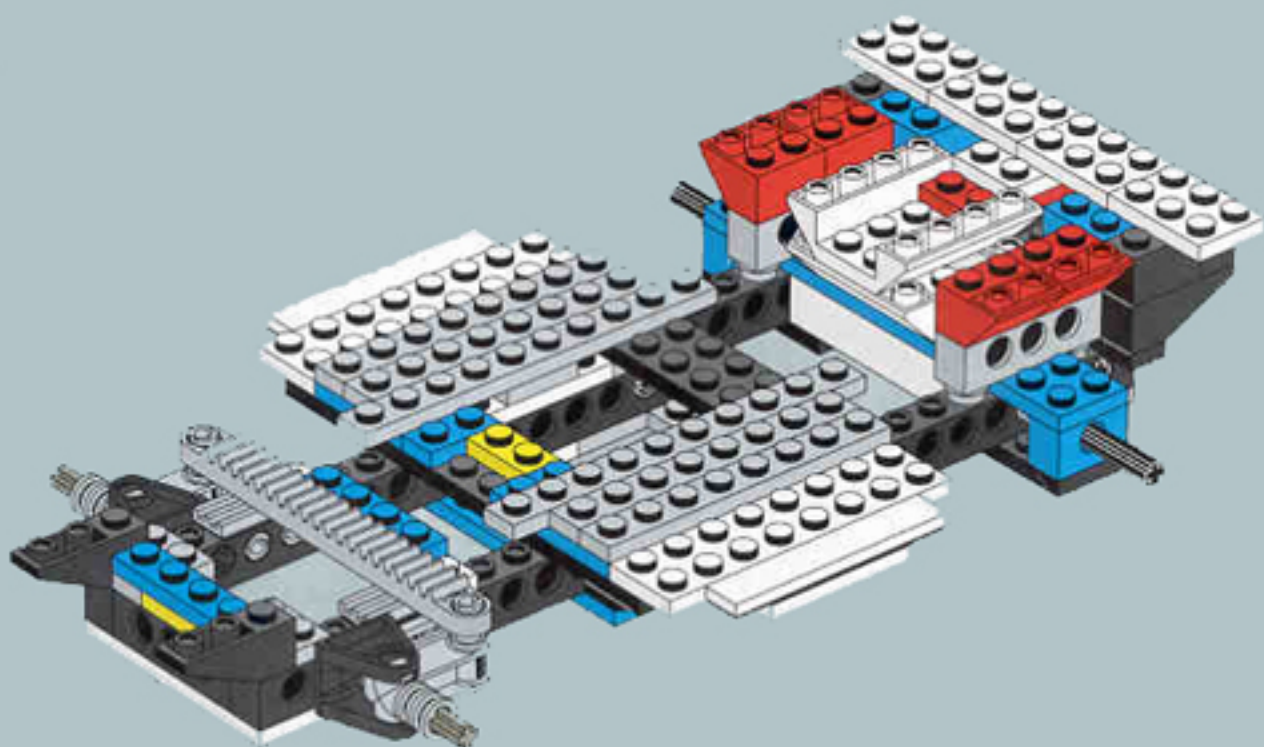

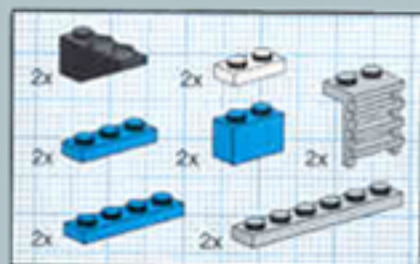

15

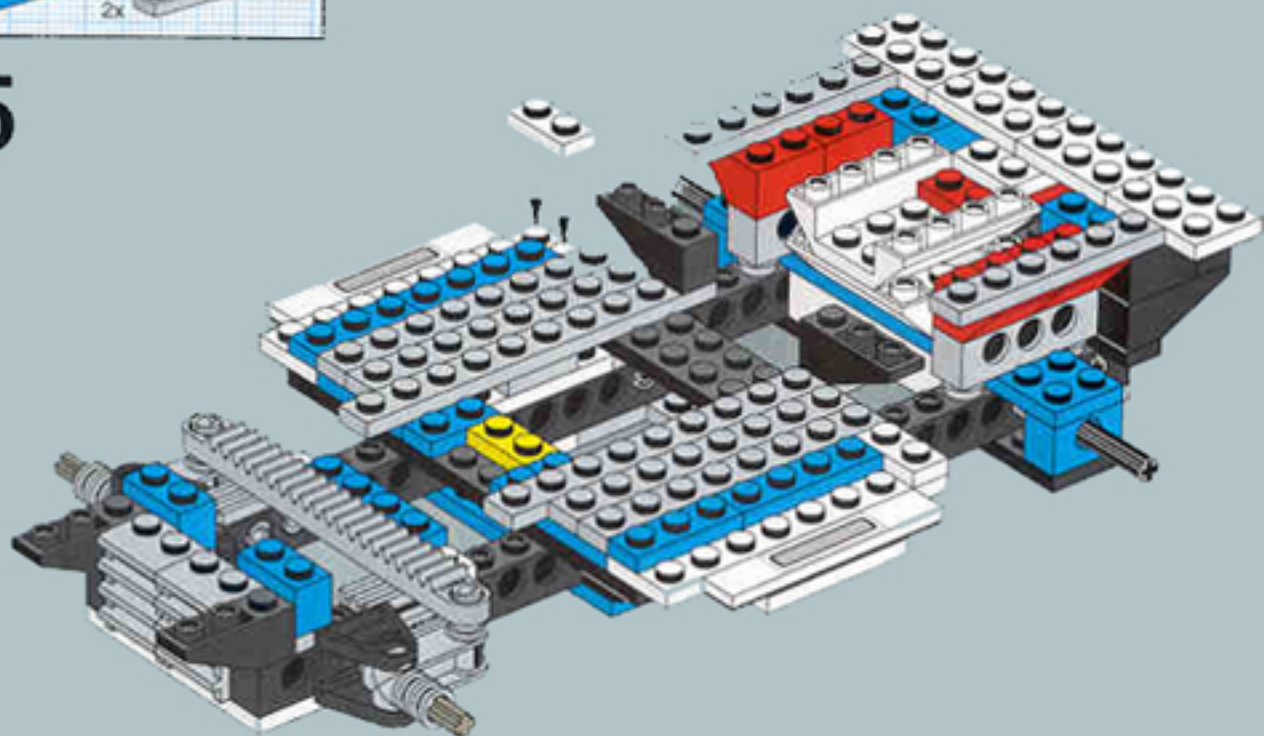

16

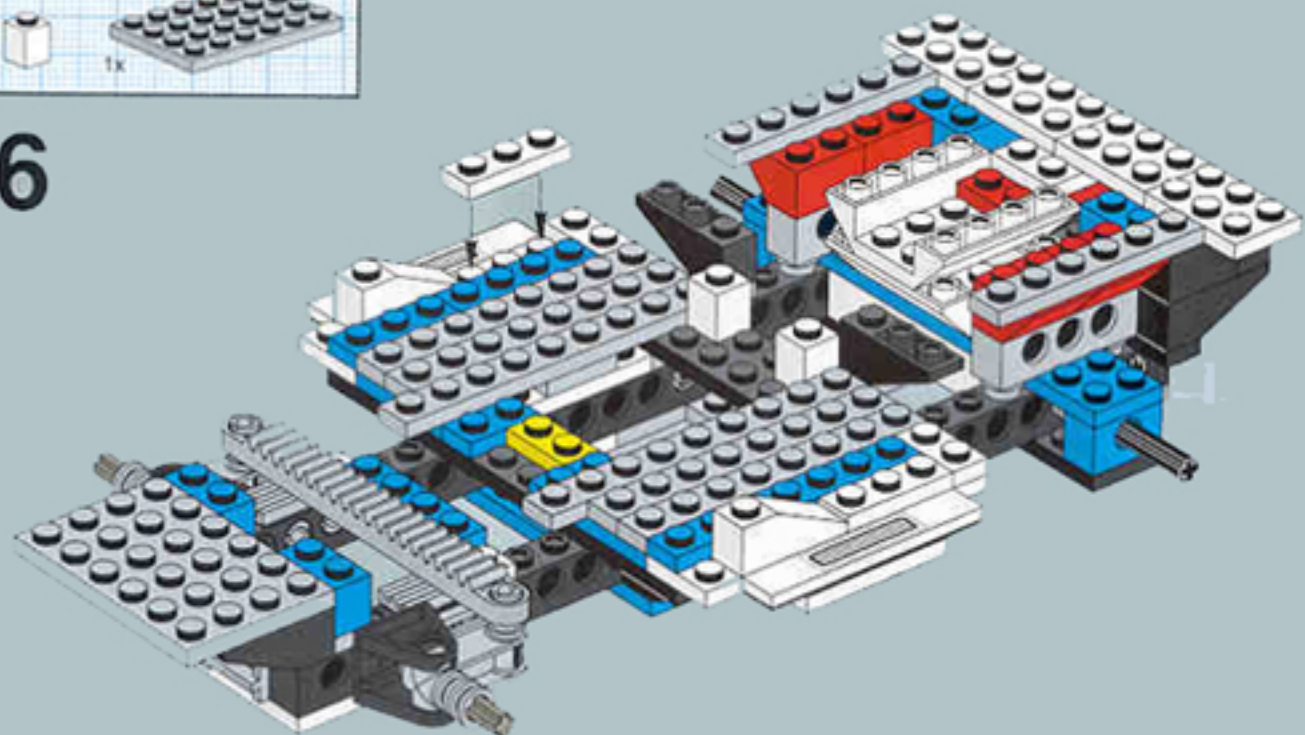



# 17

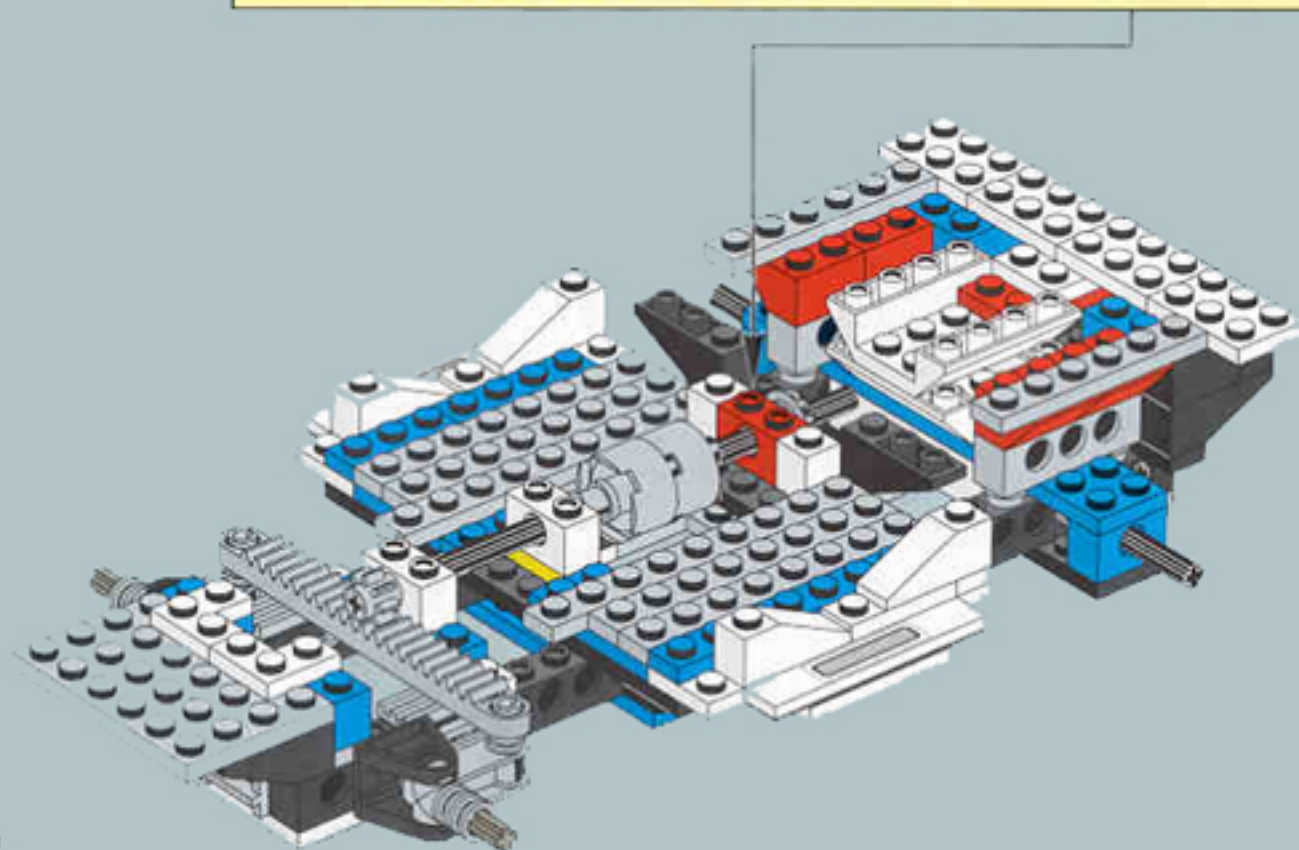
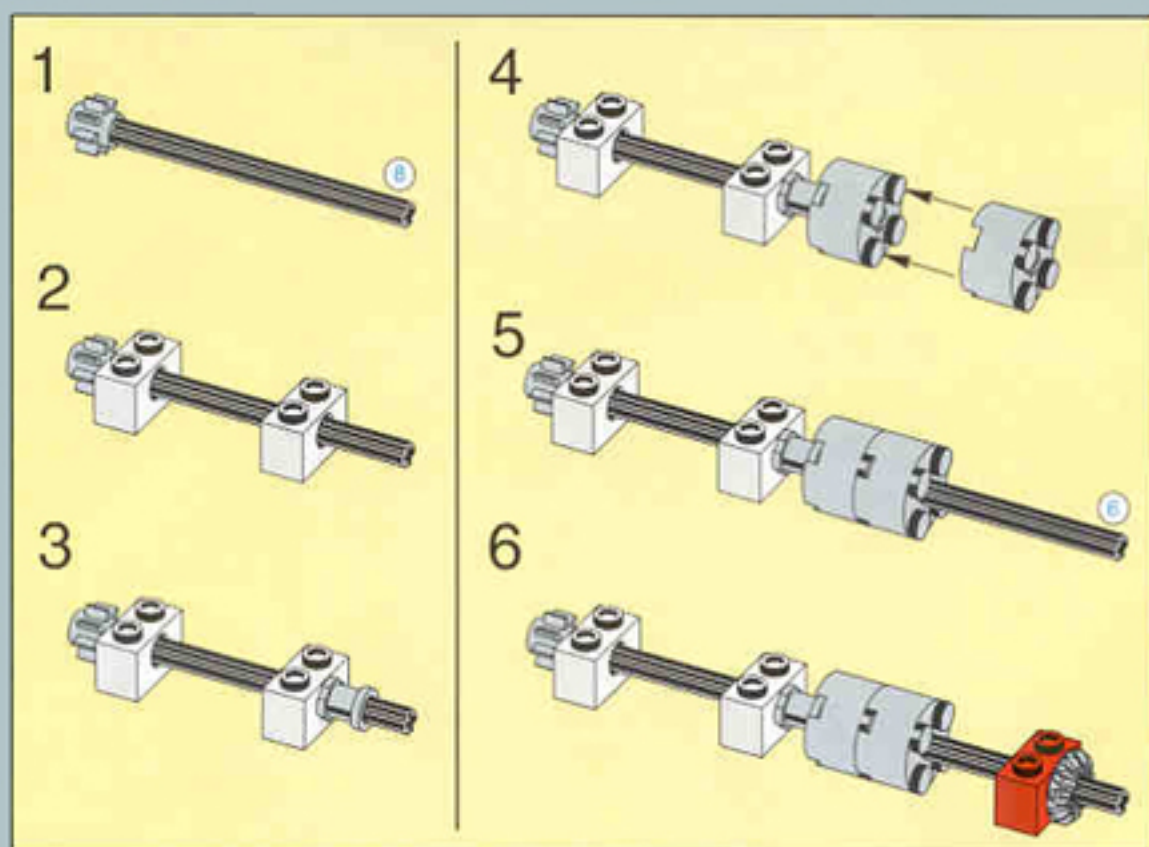



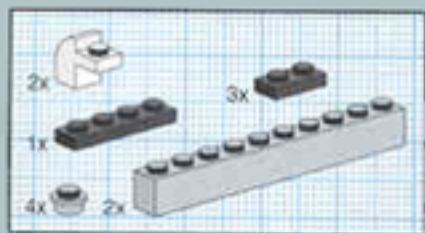

18

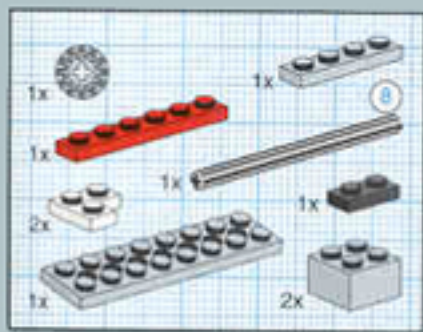
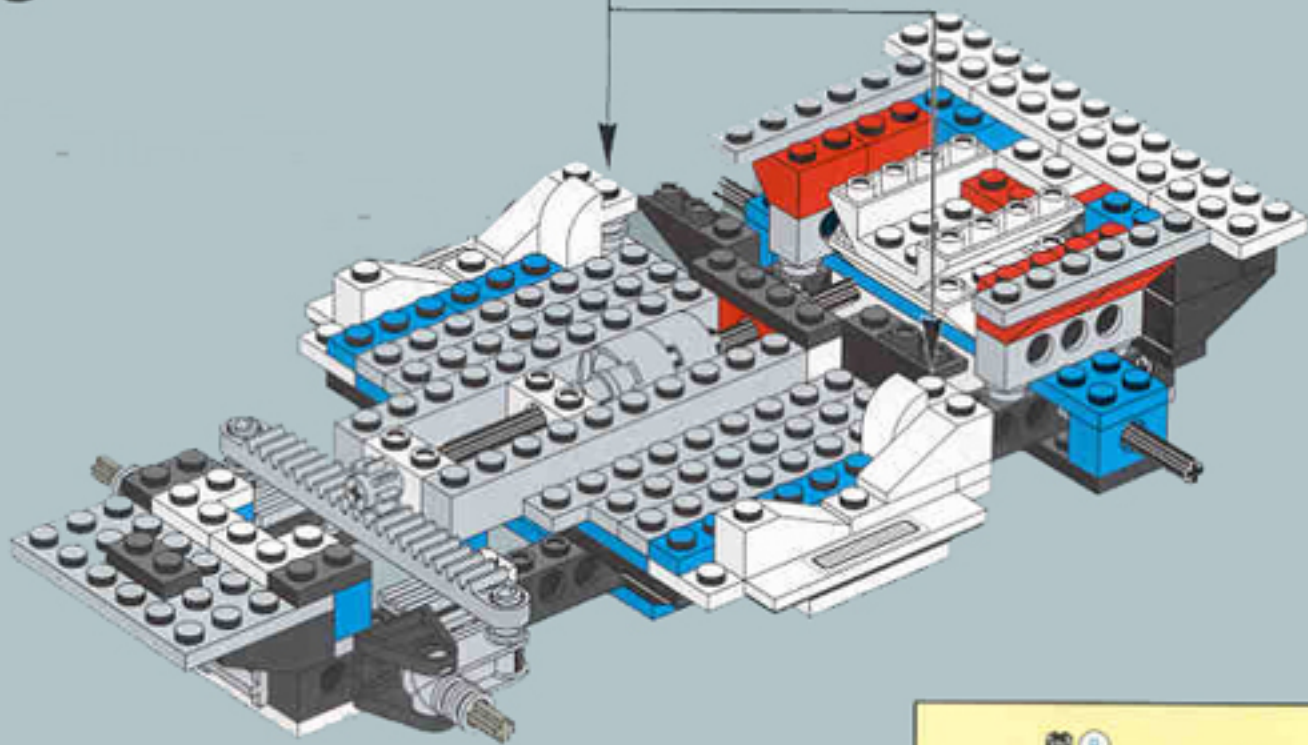

19

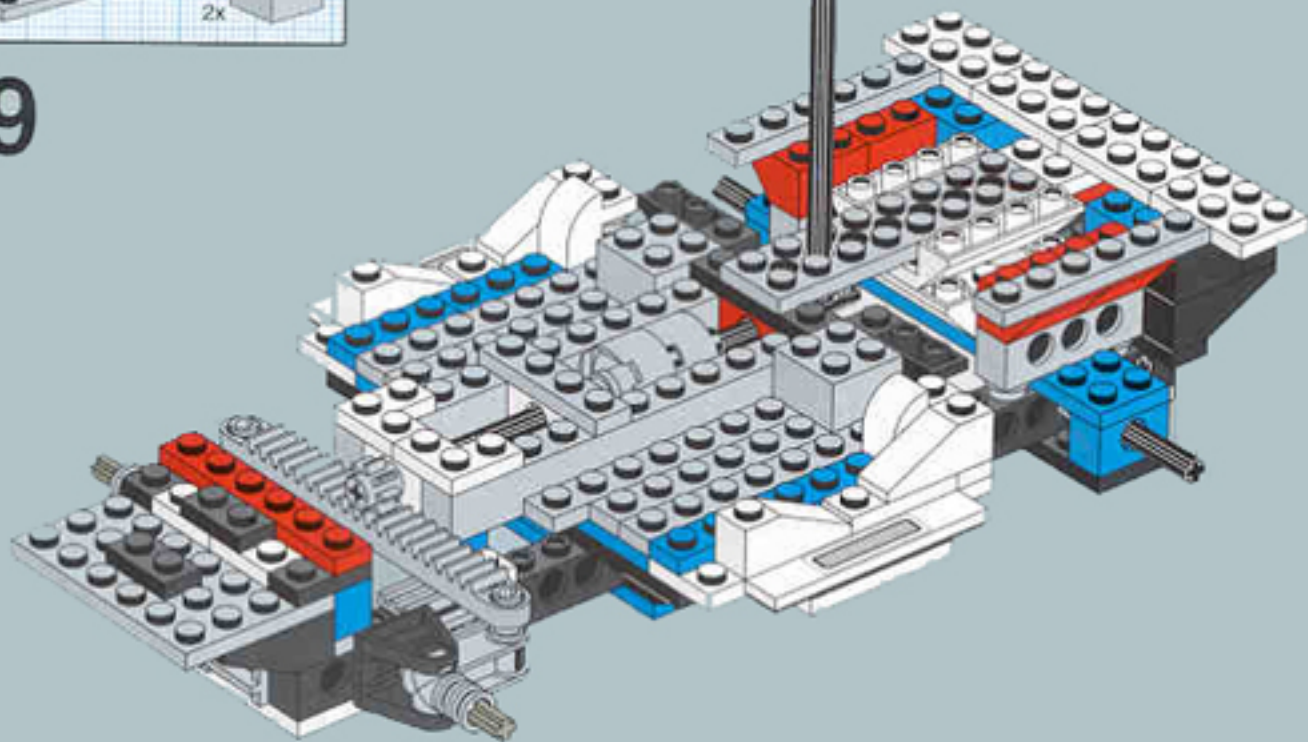
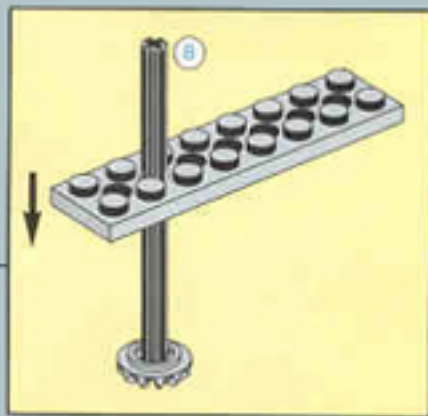



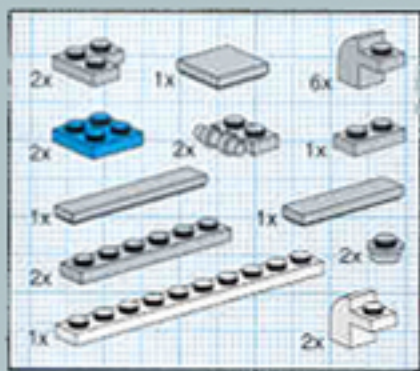

# 21

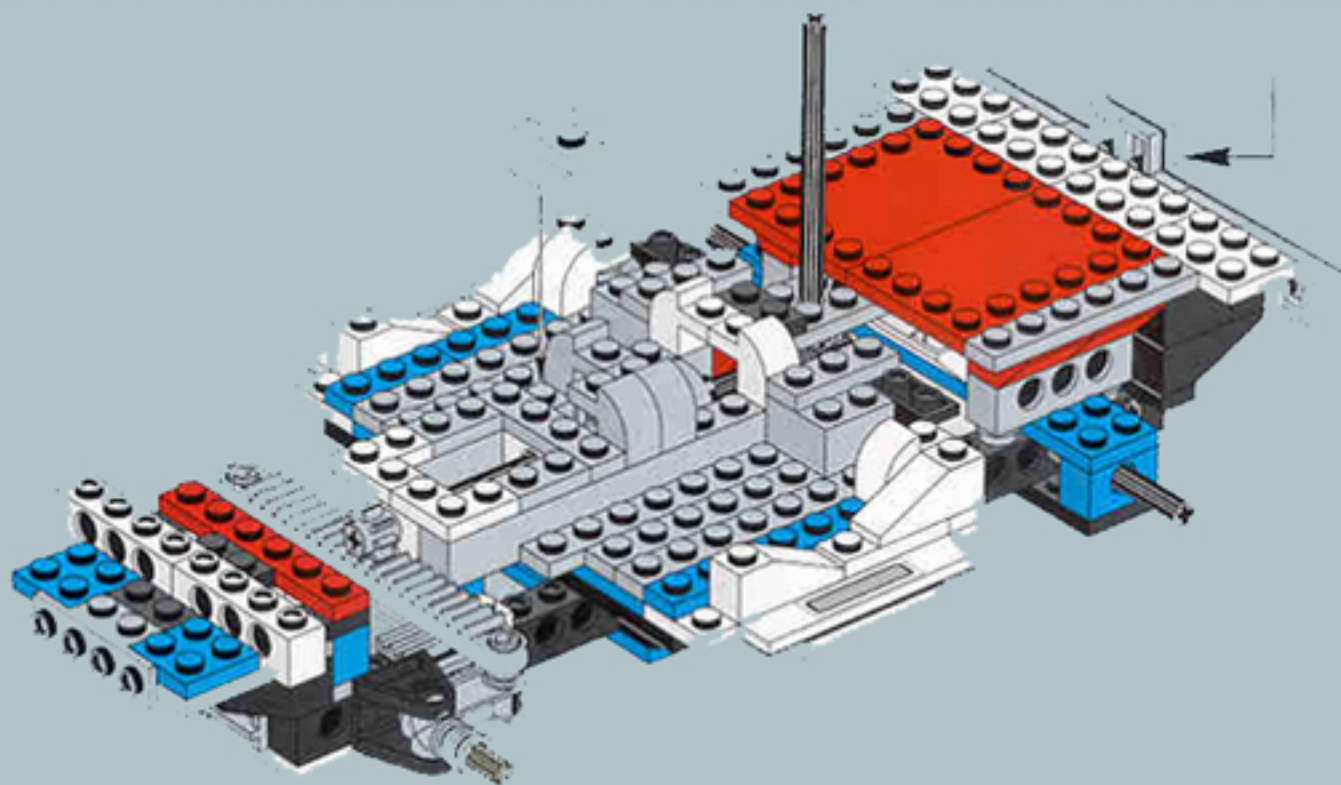
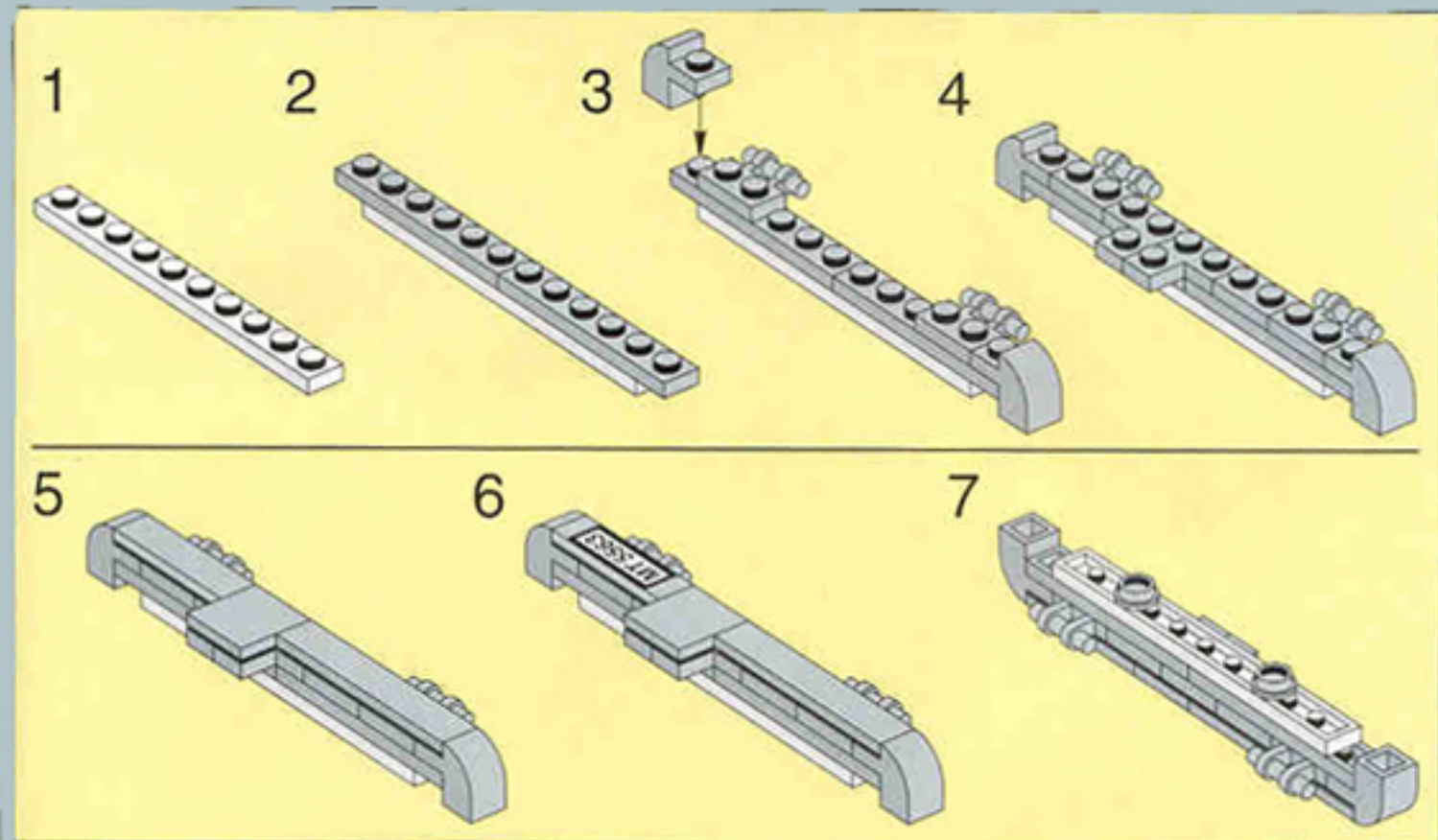

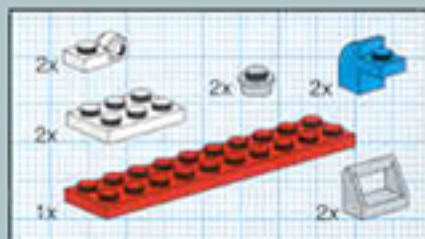

22

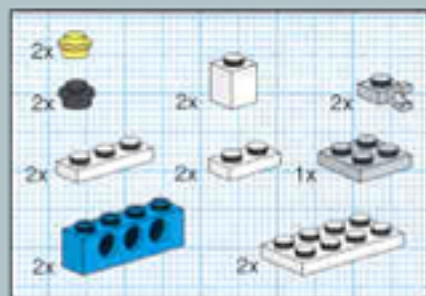
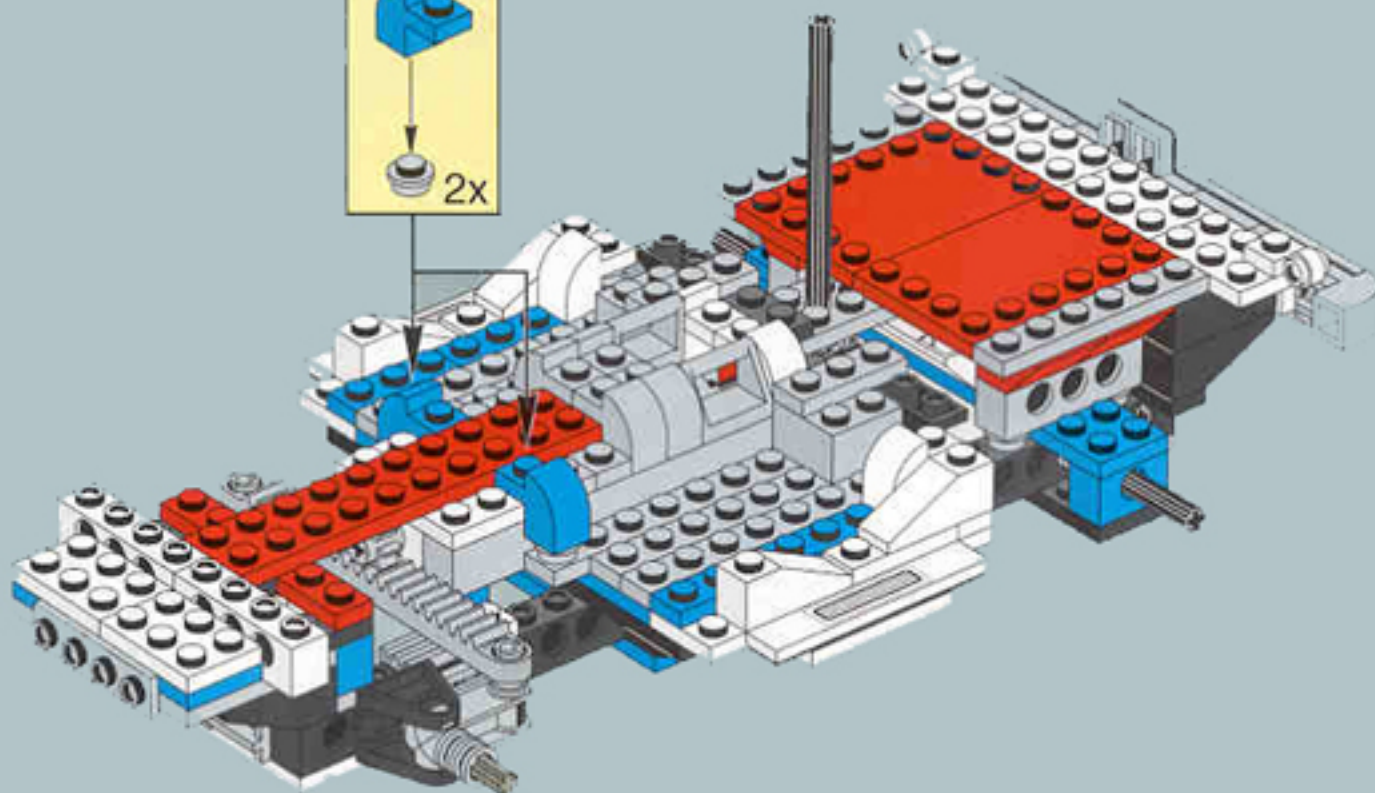

23

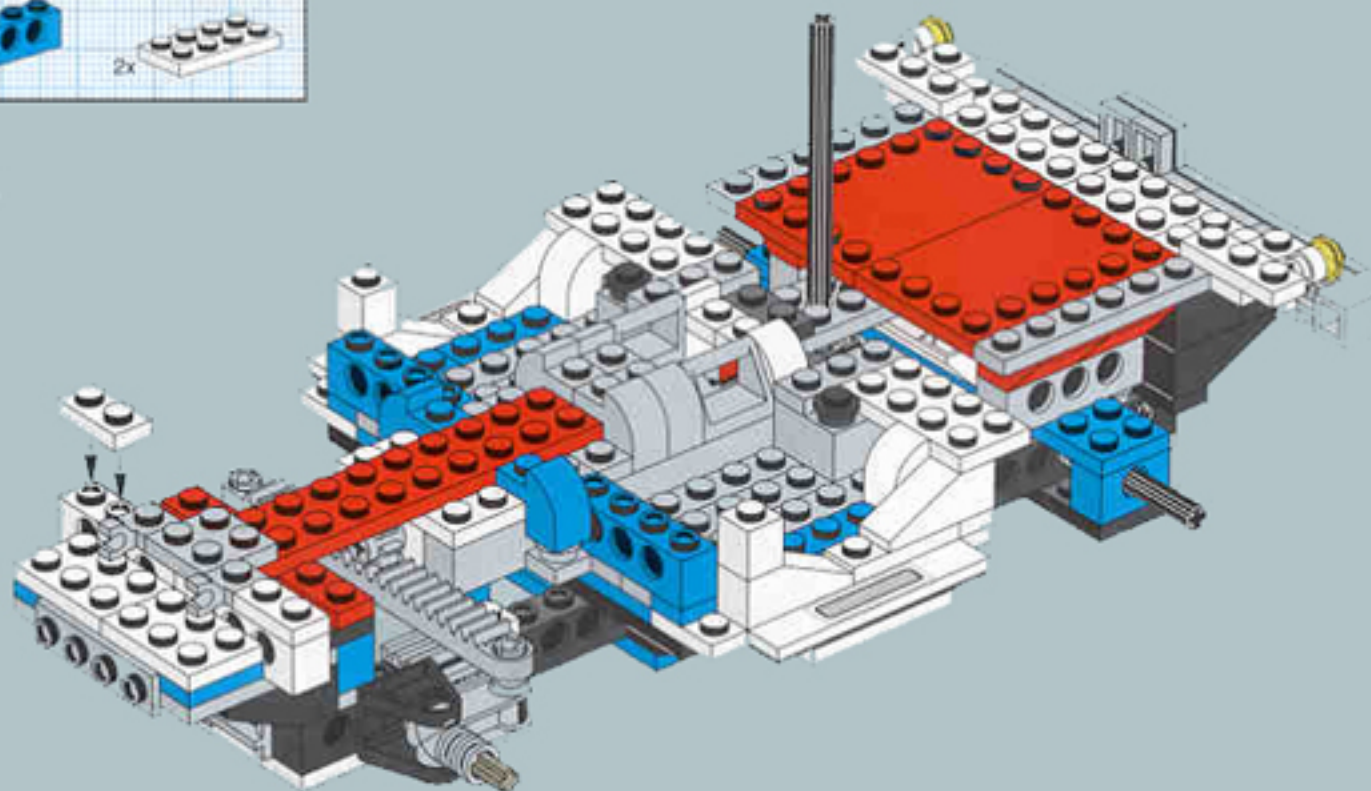



24

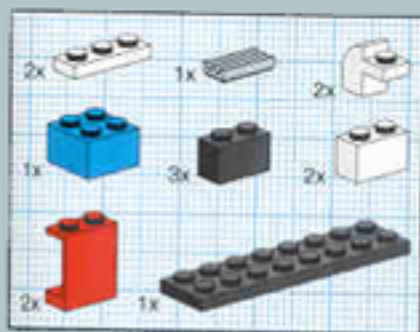
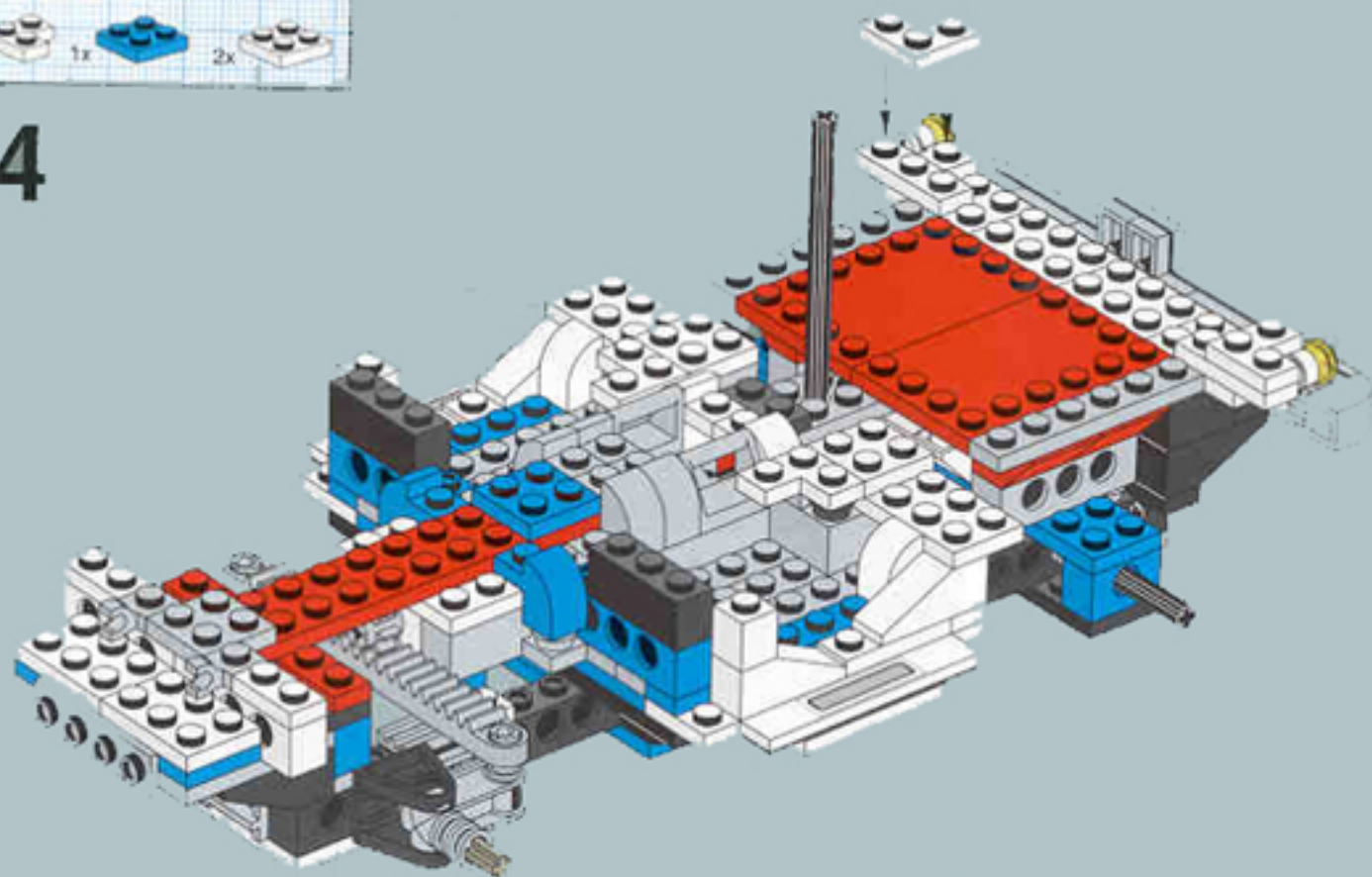

25

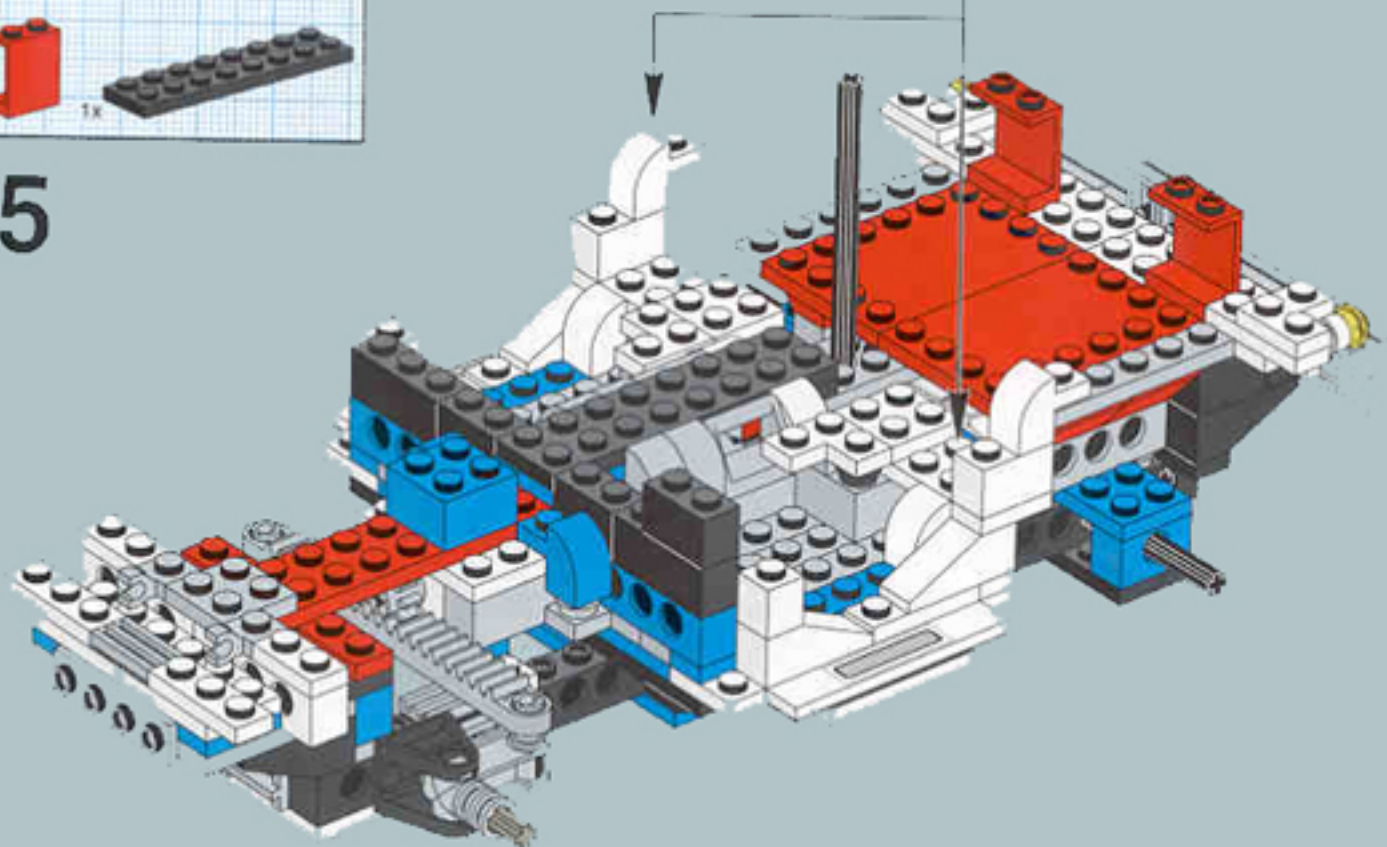

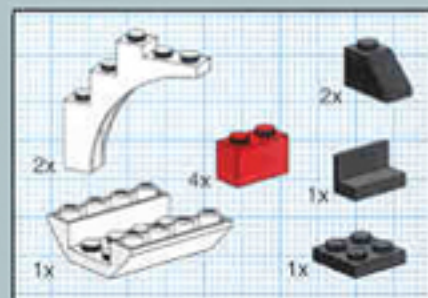

26

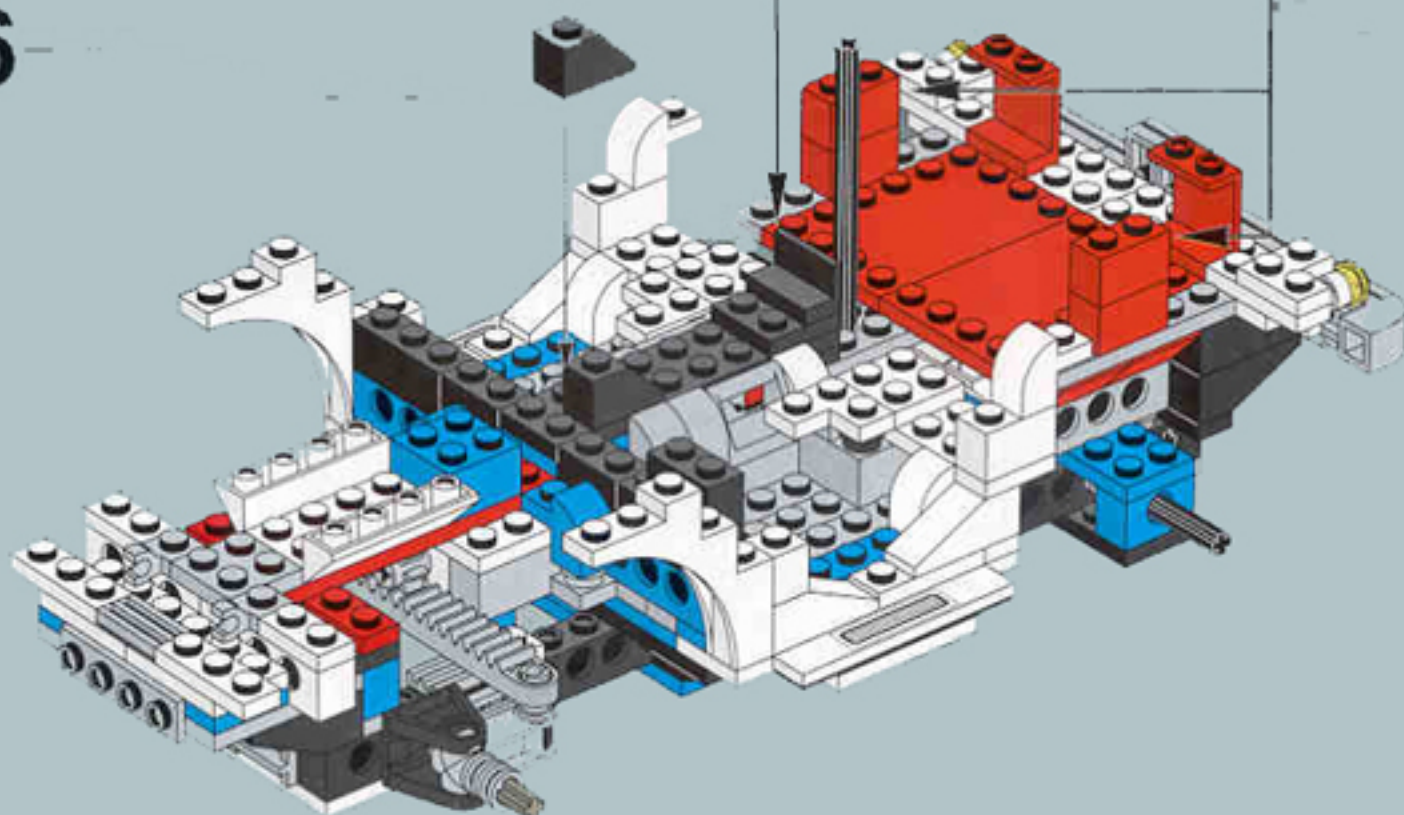
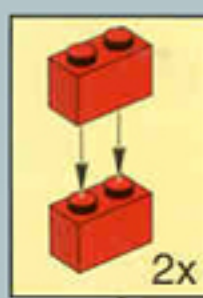

27

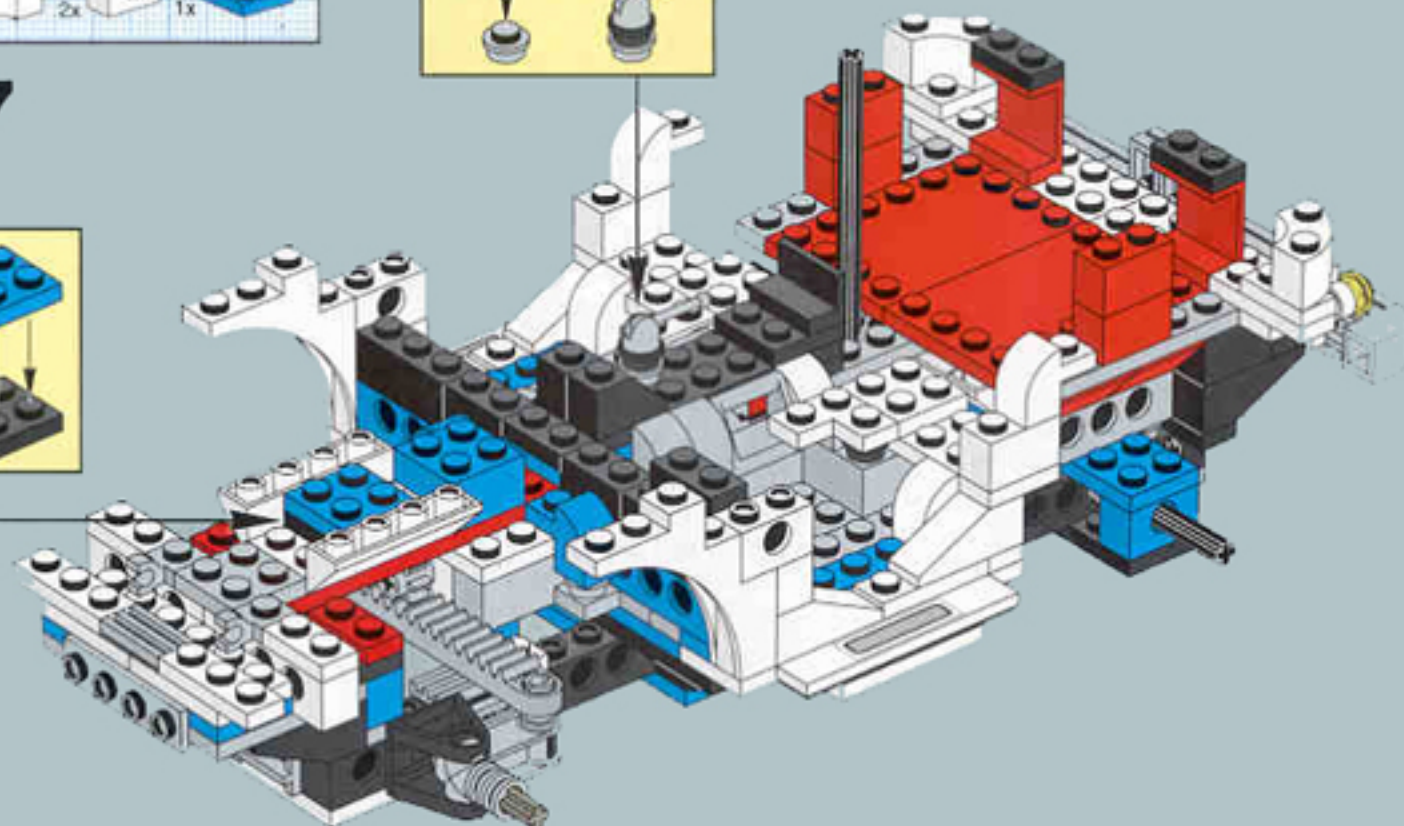
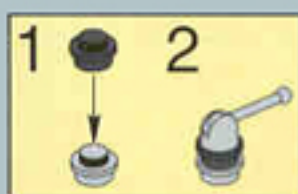

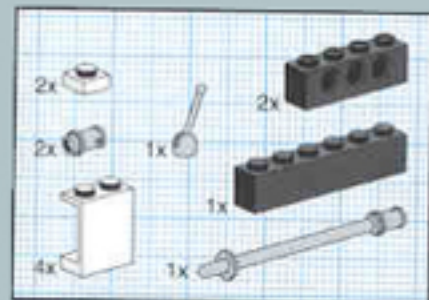

28

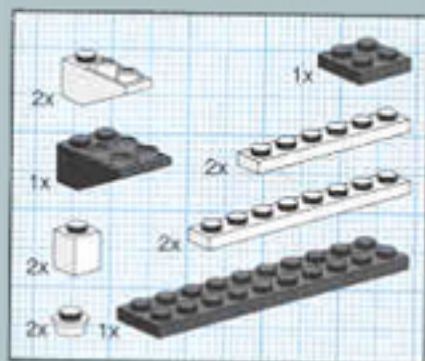
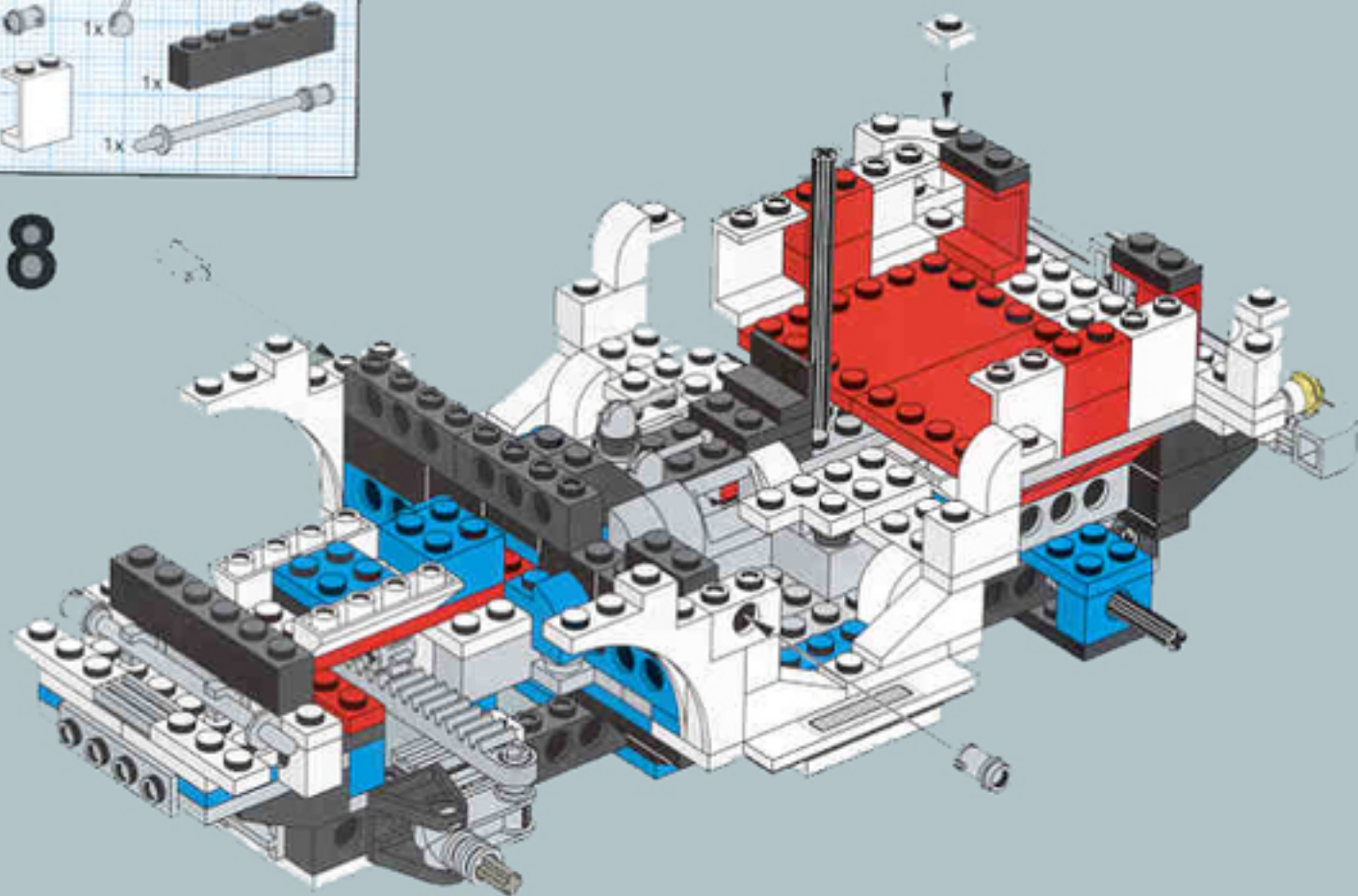

29

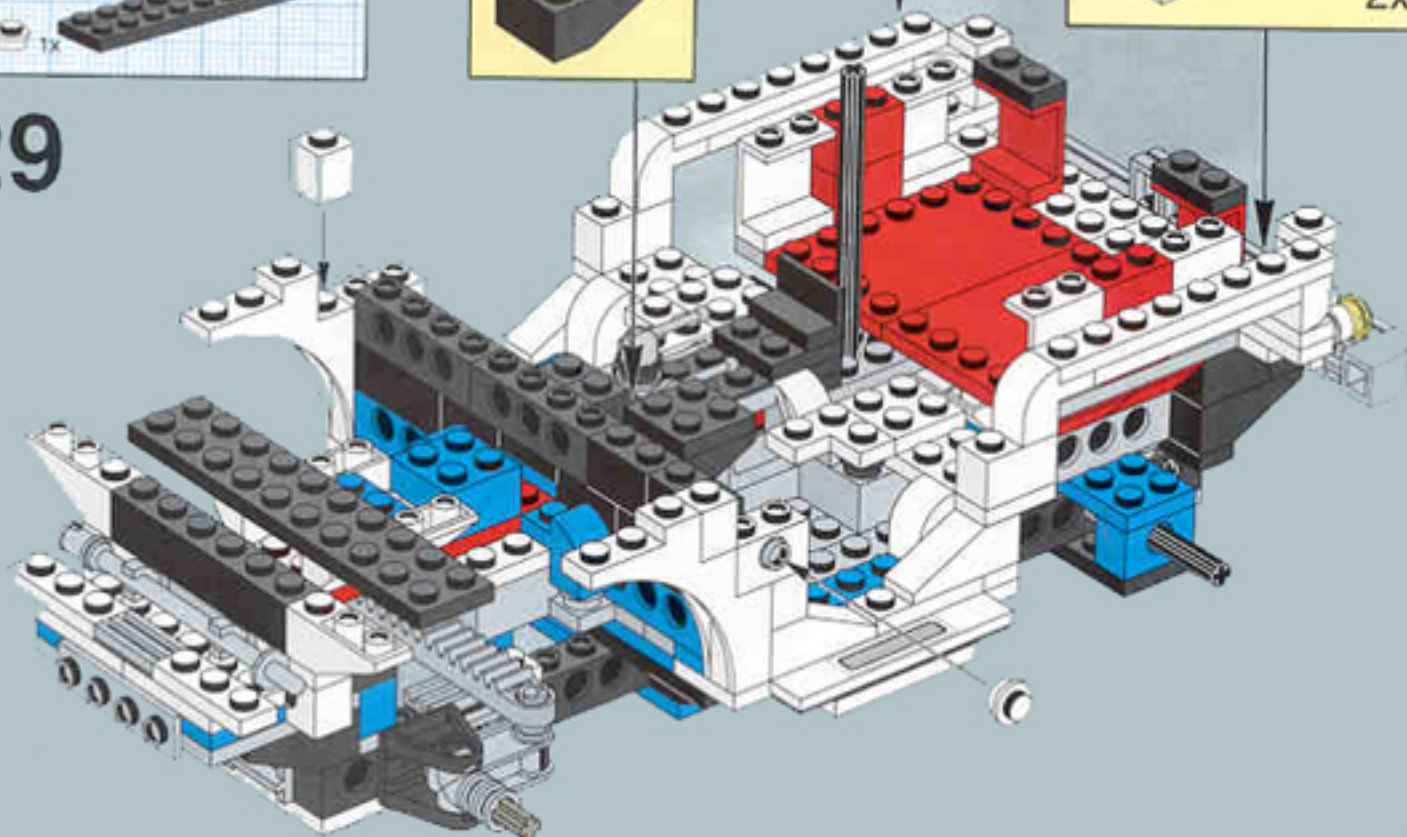
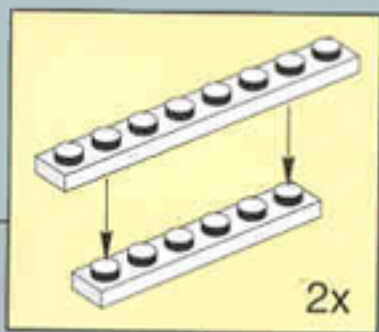

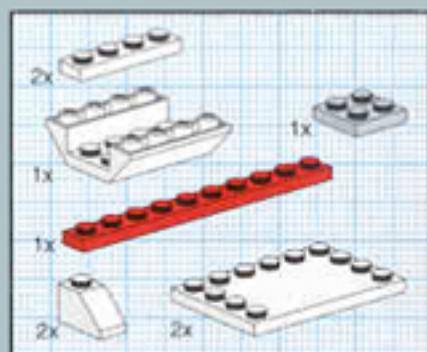

30

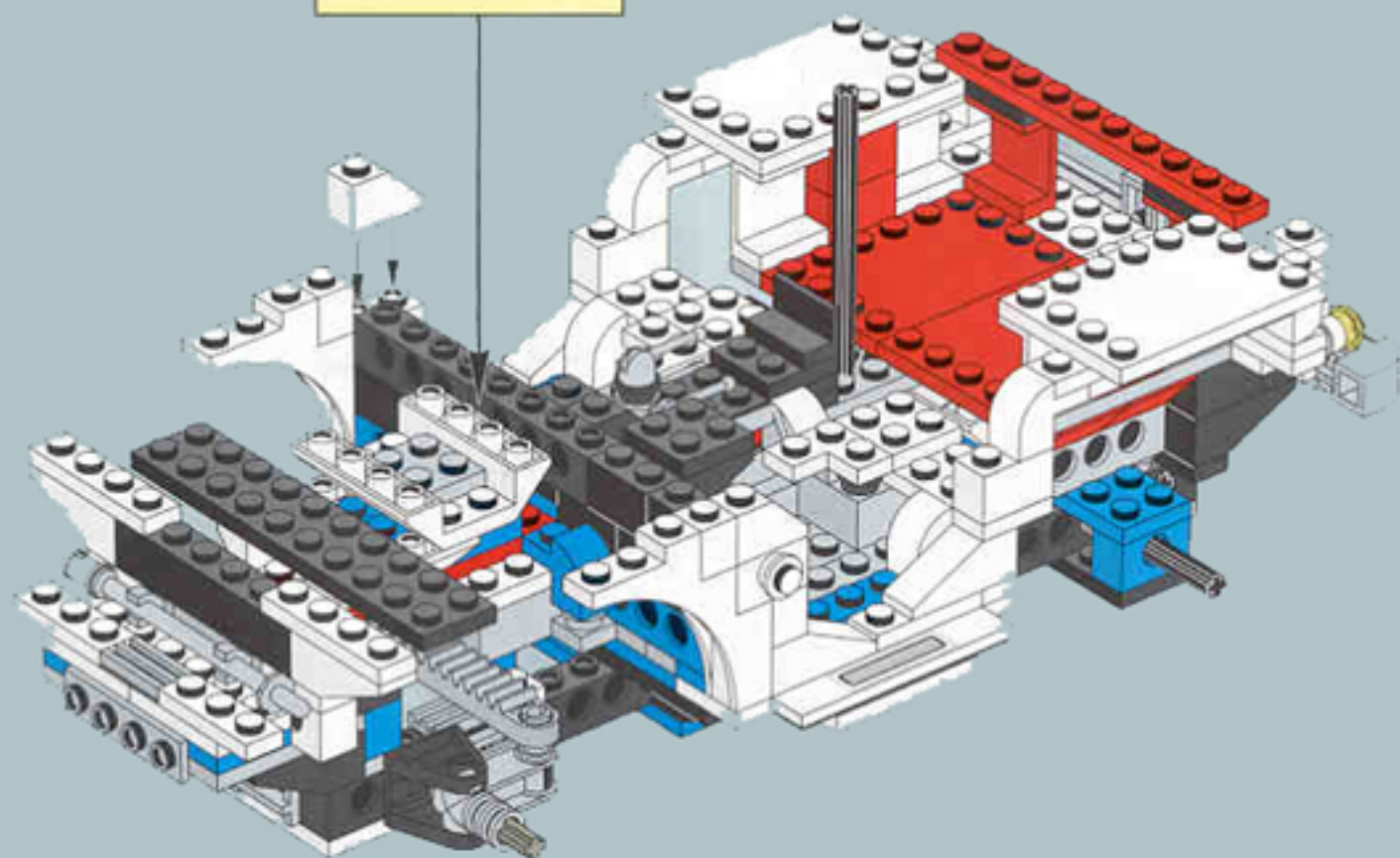
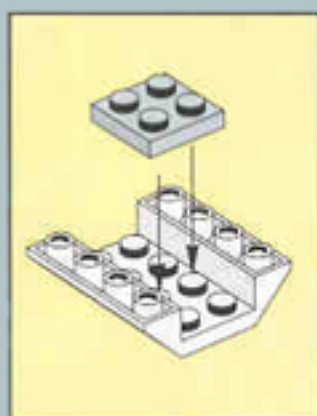



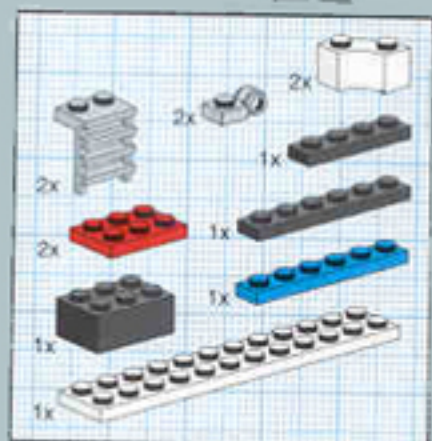

31

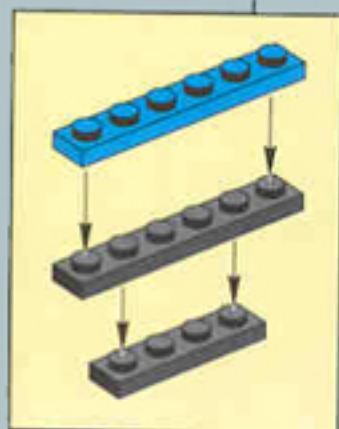
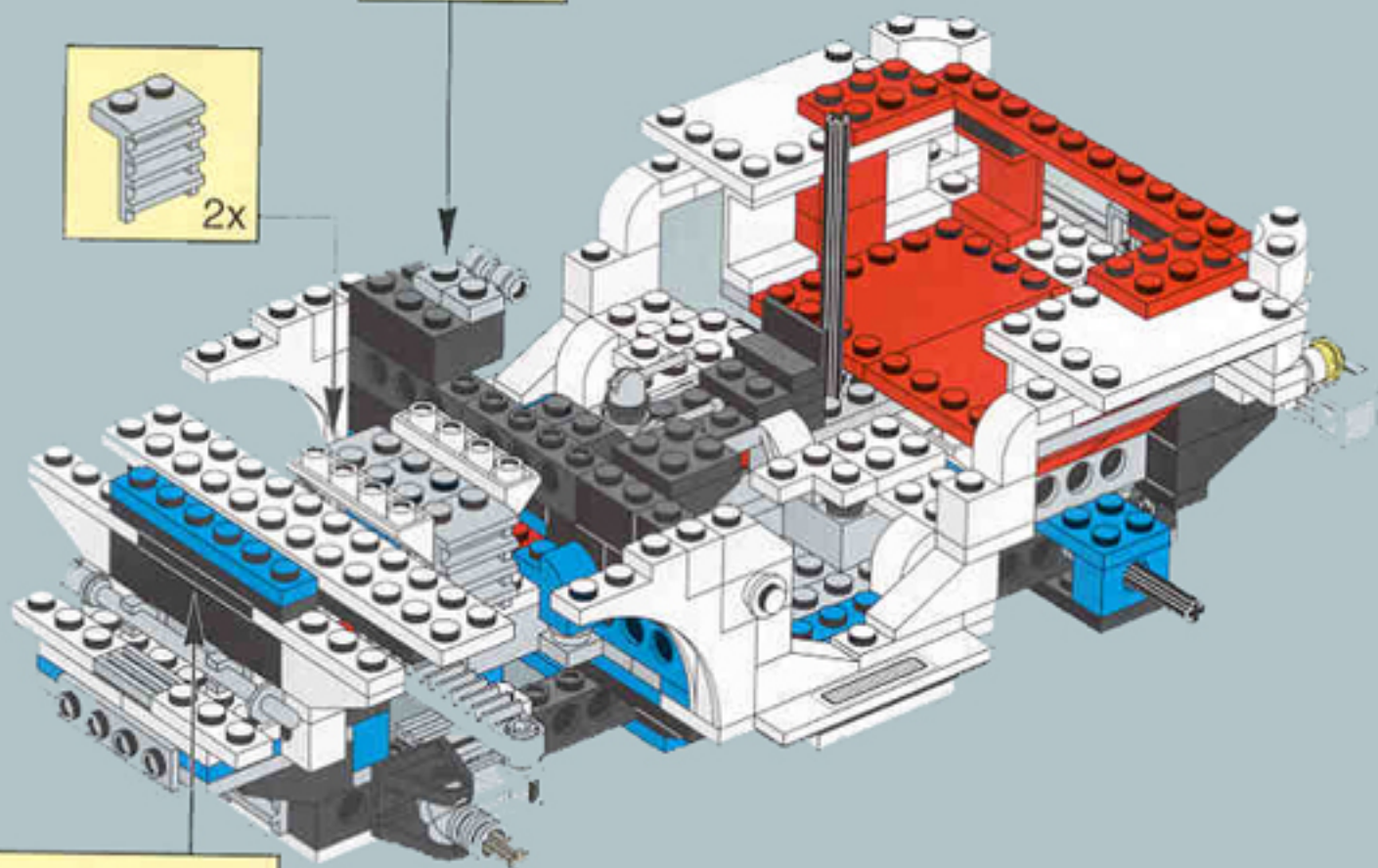

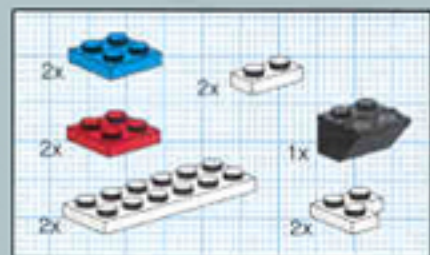

# 32

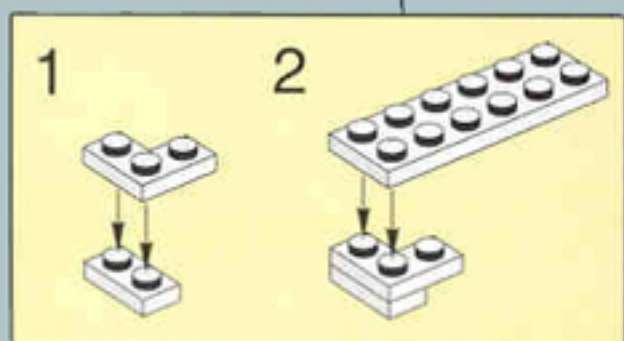
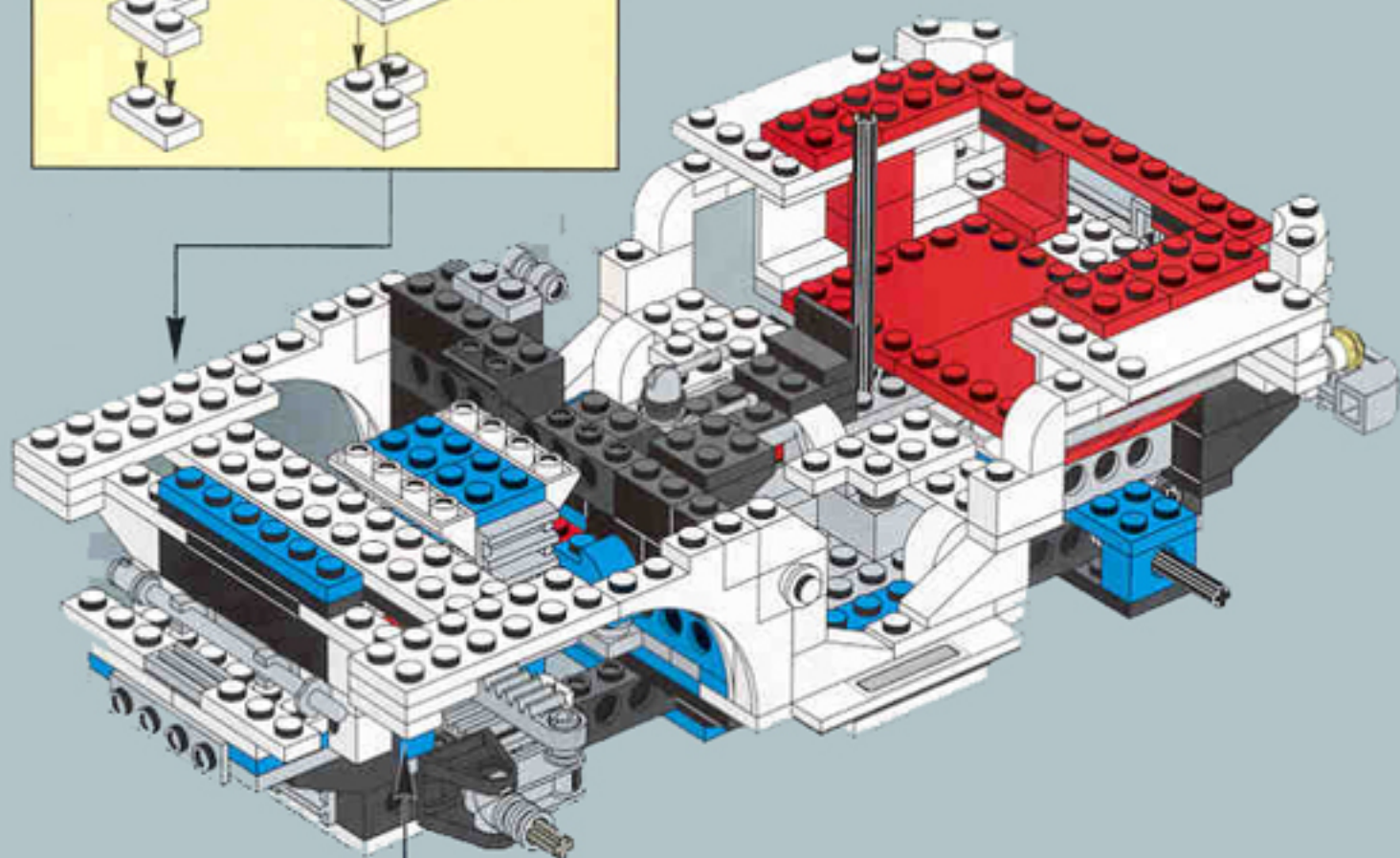
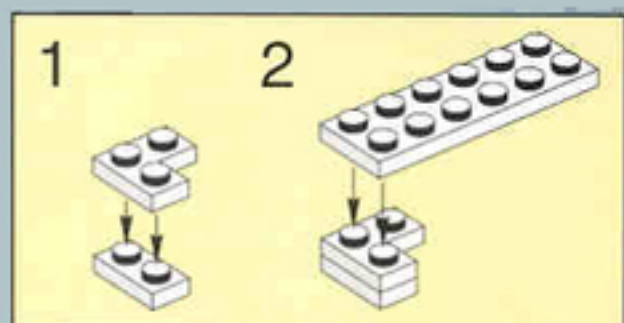









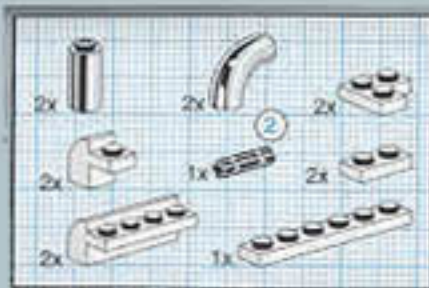

# 36

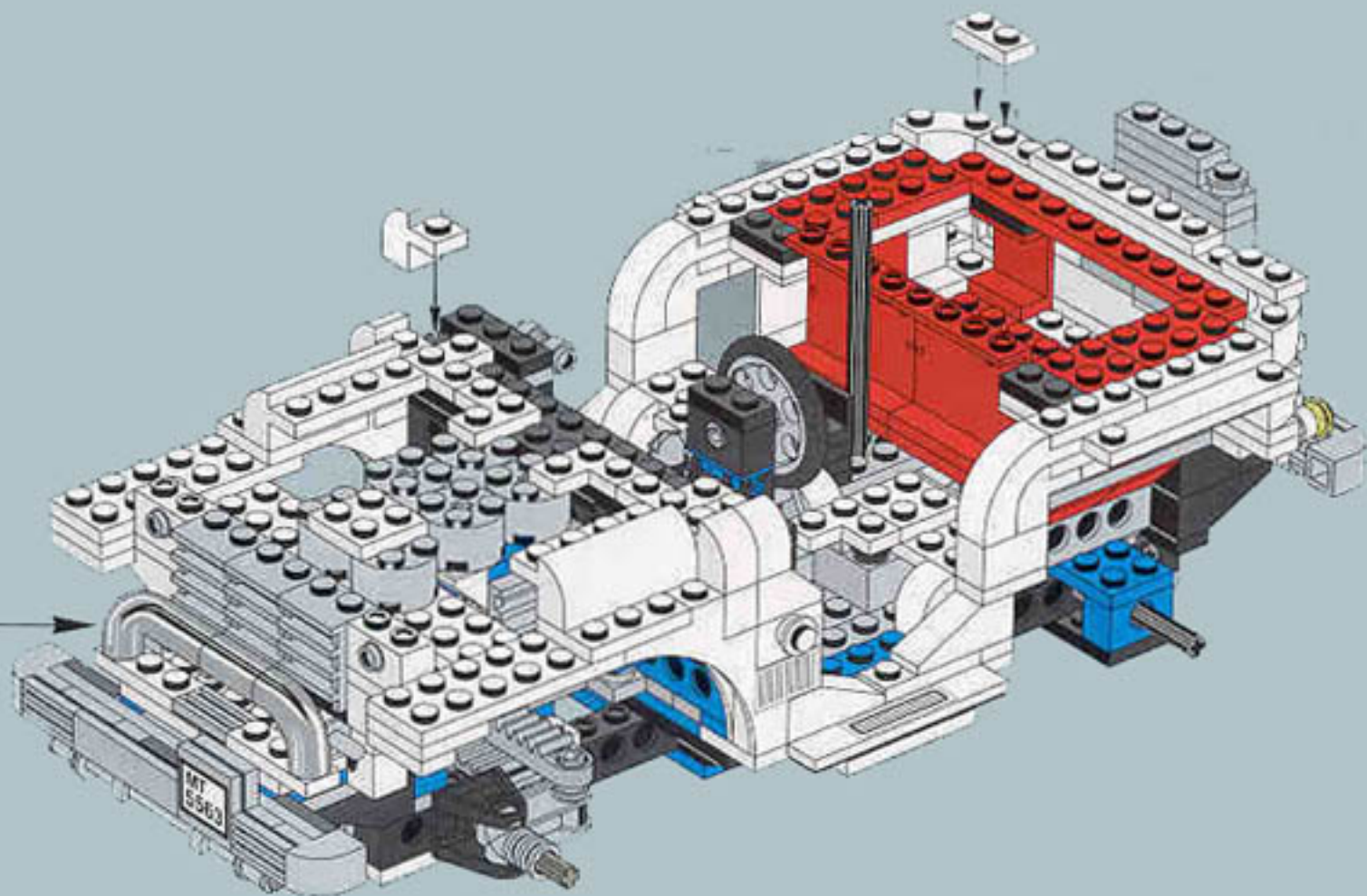
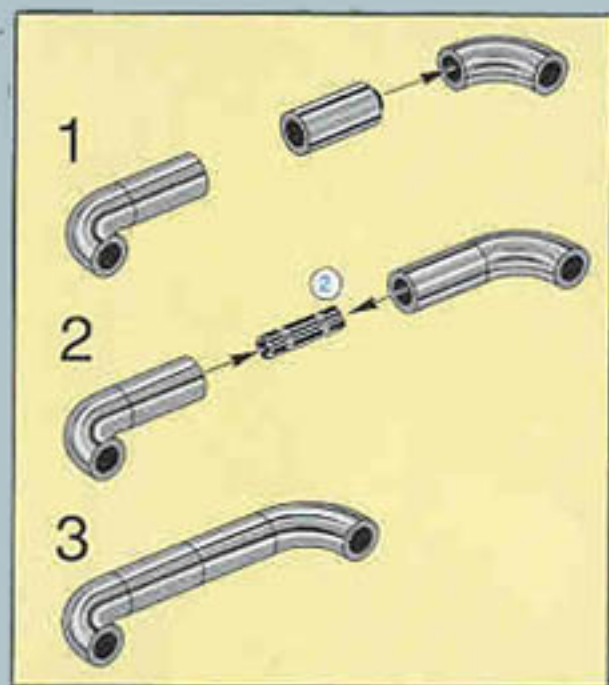

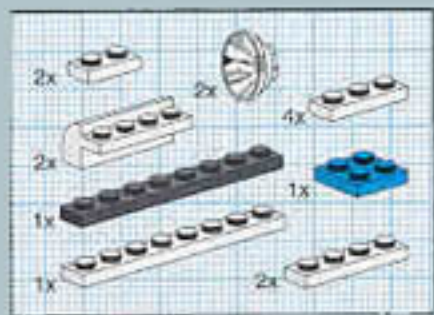

37

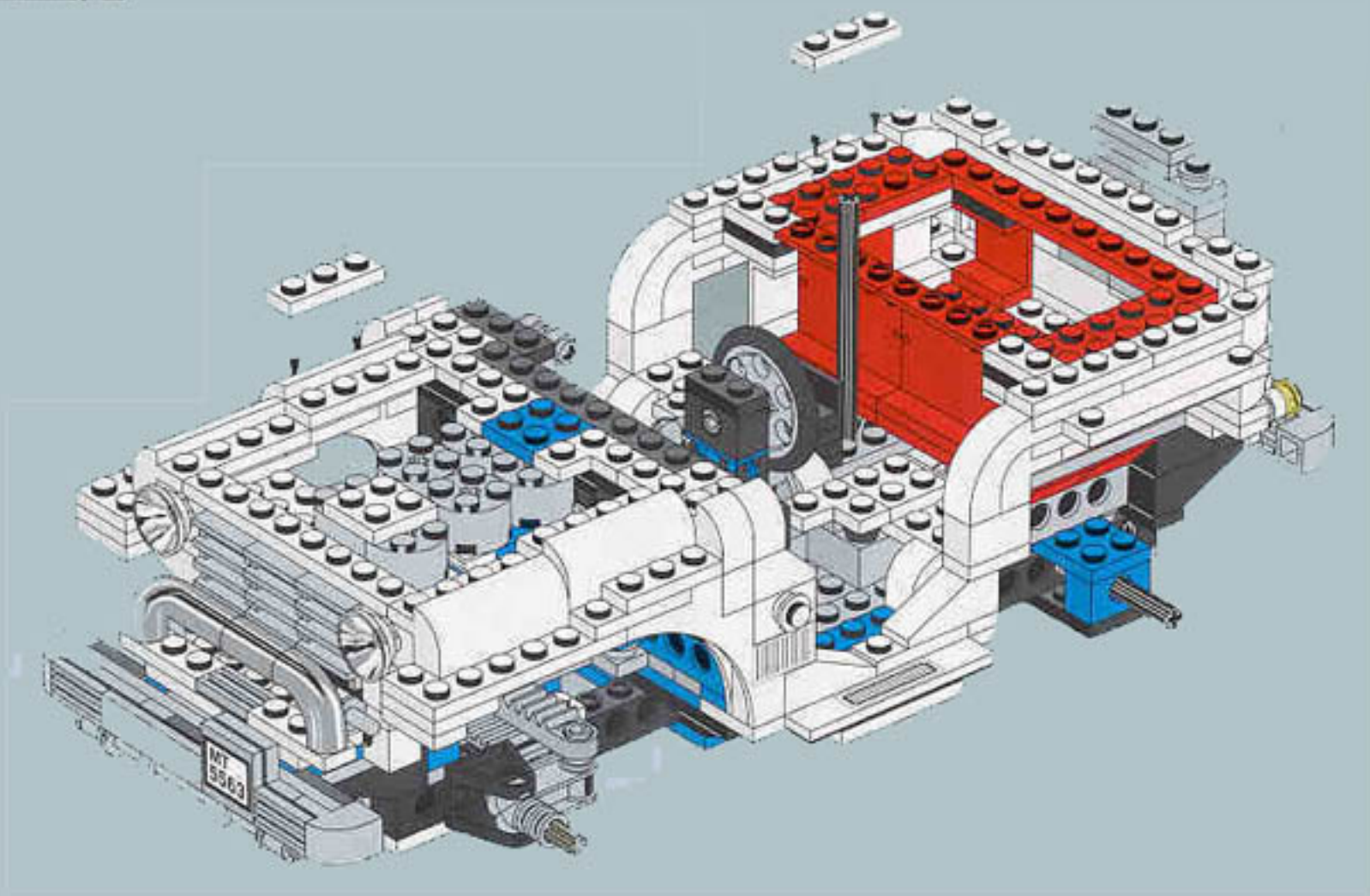



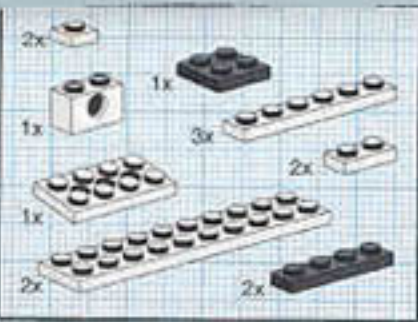

38

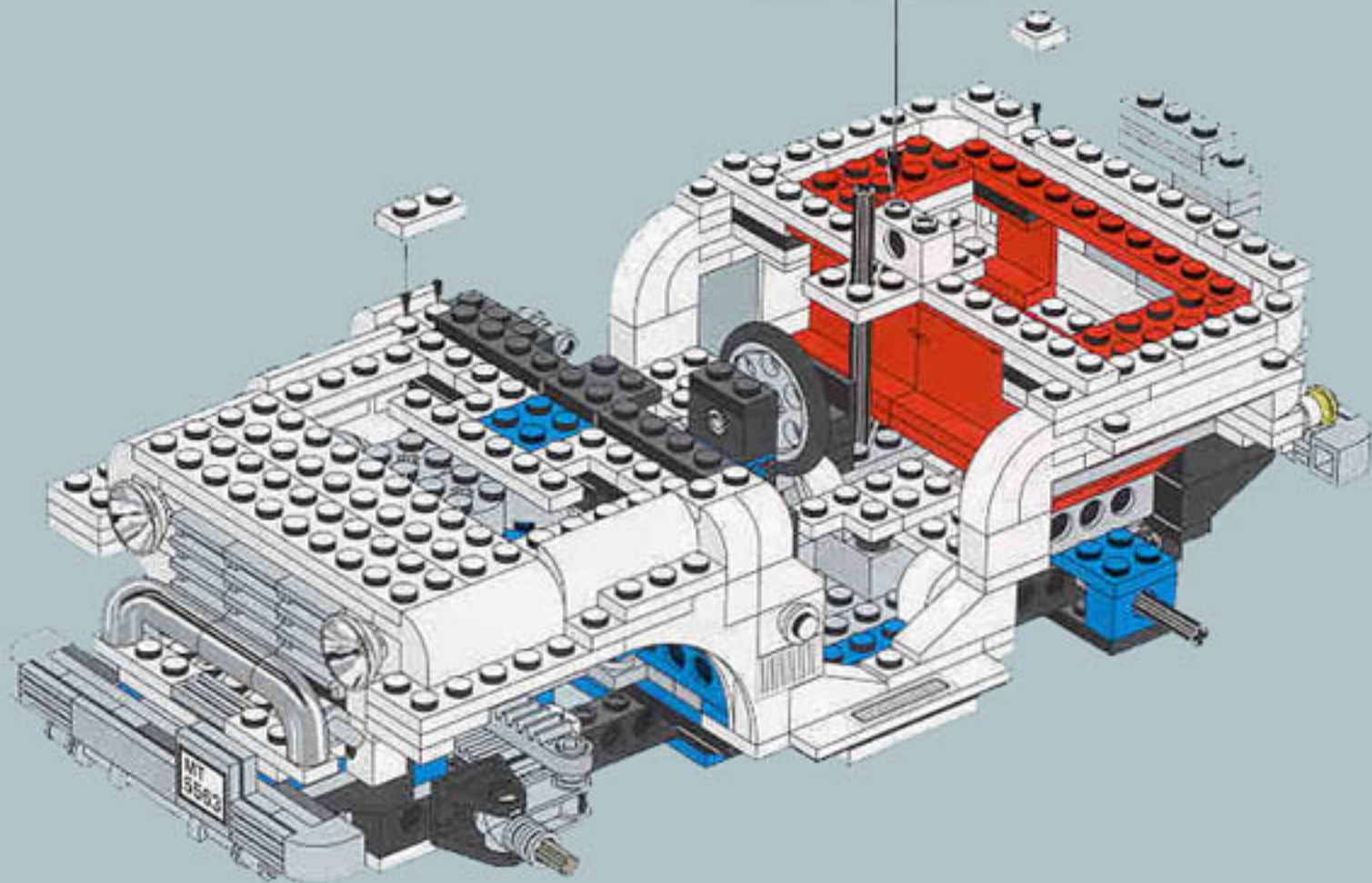
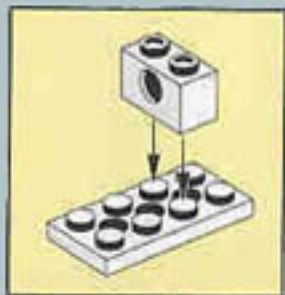

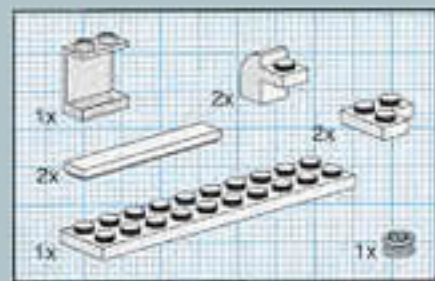

39

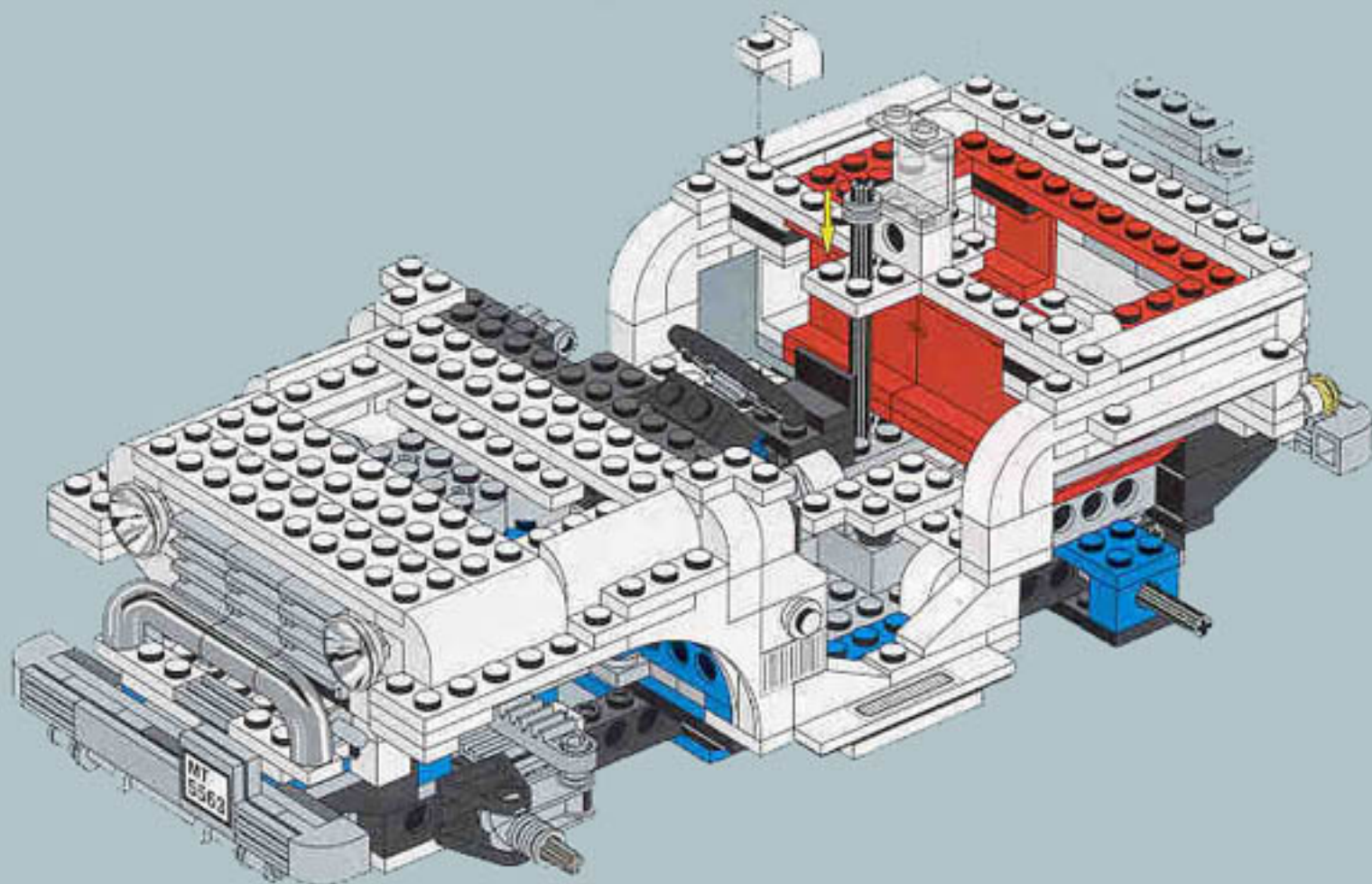



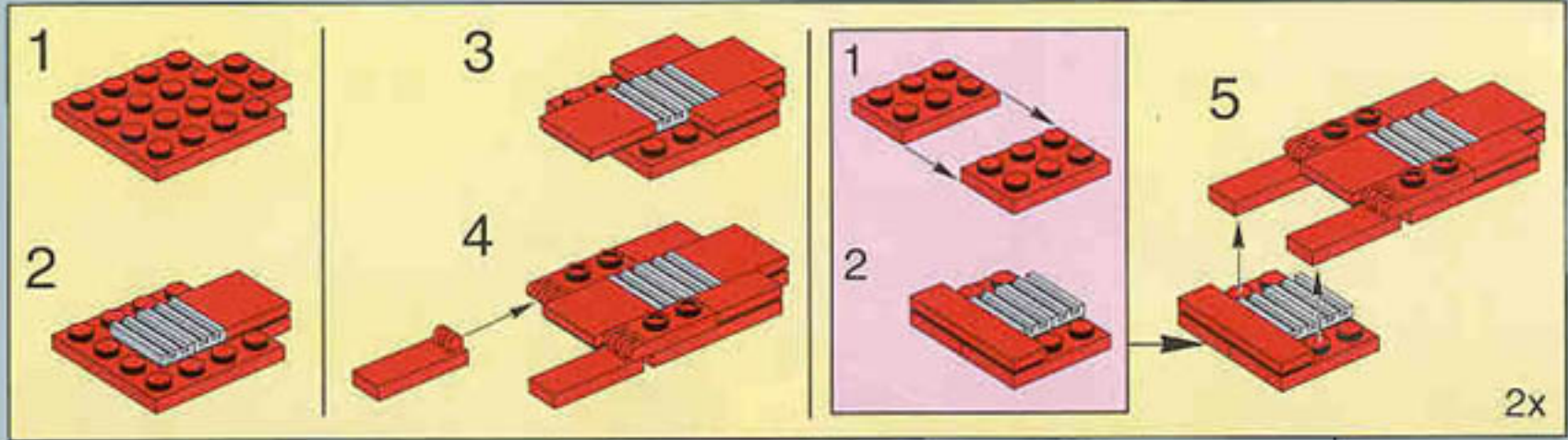

41

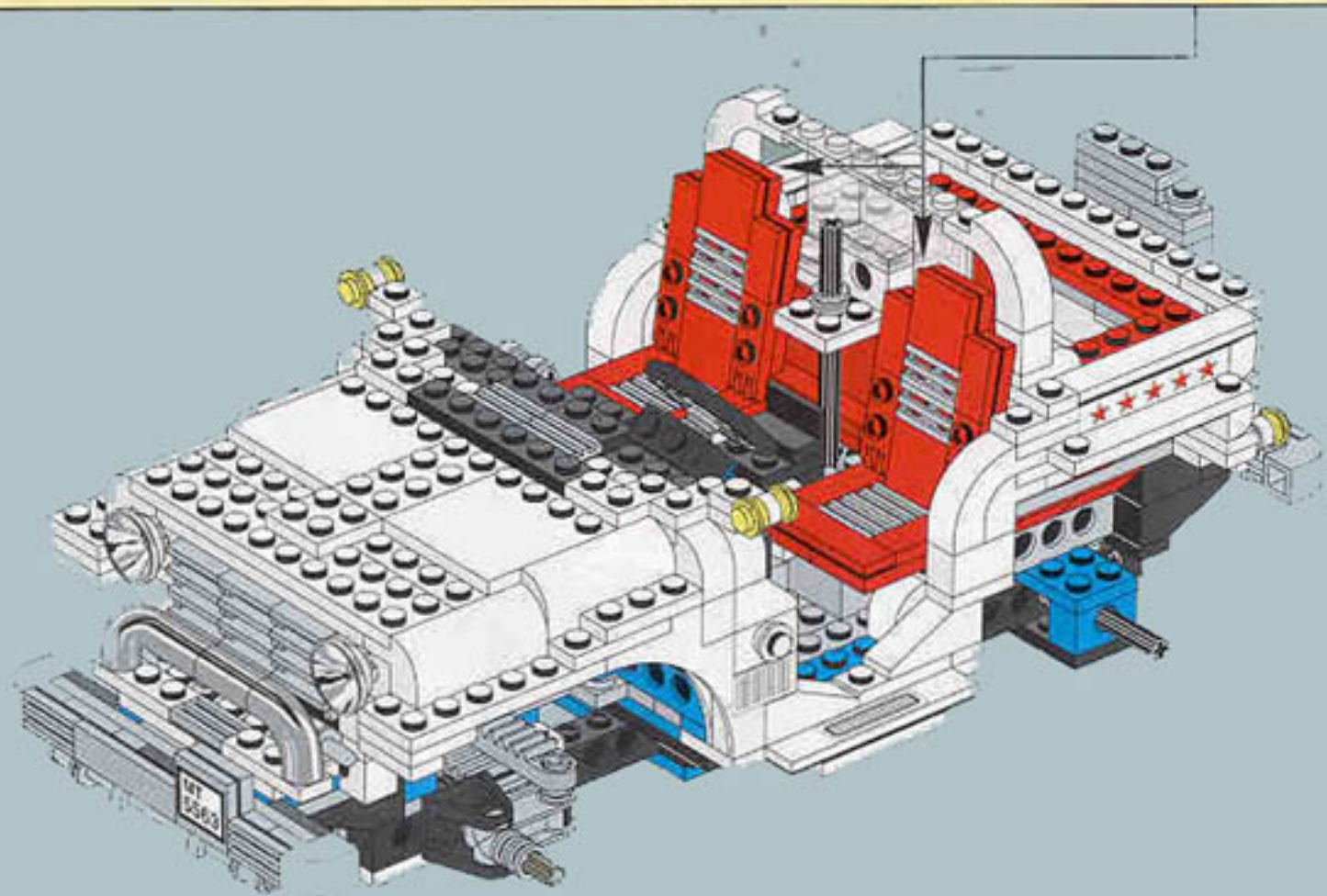

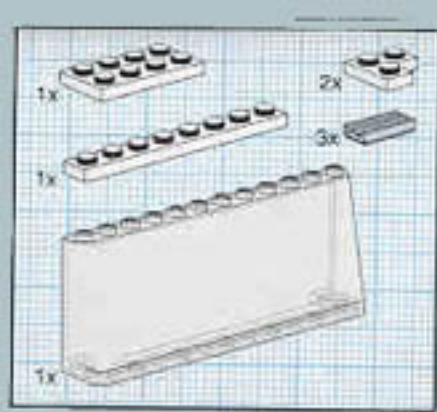

42

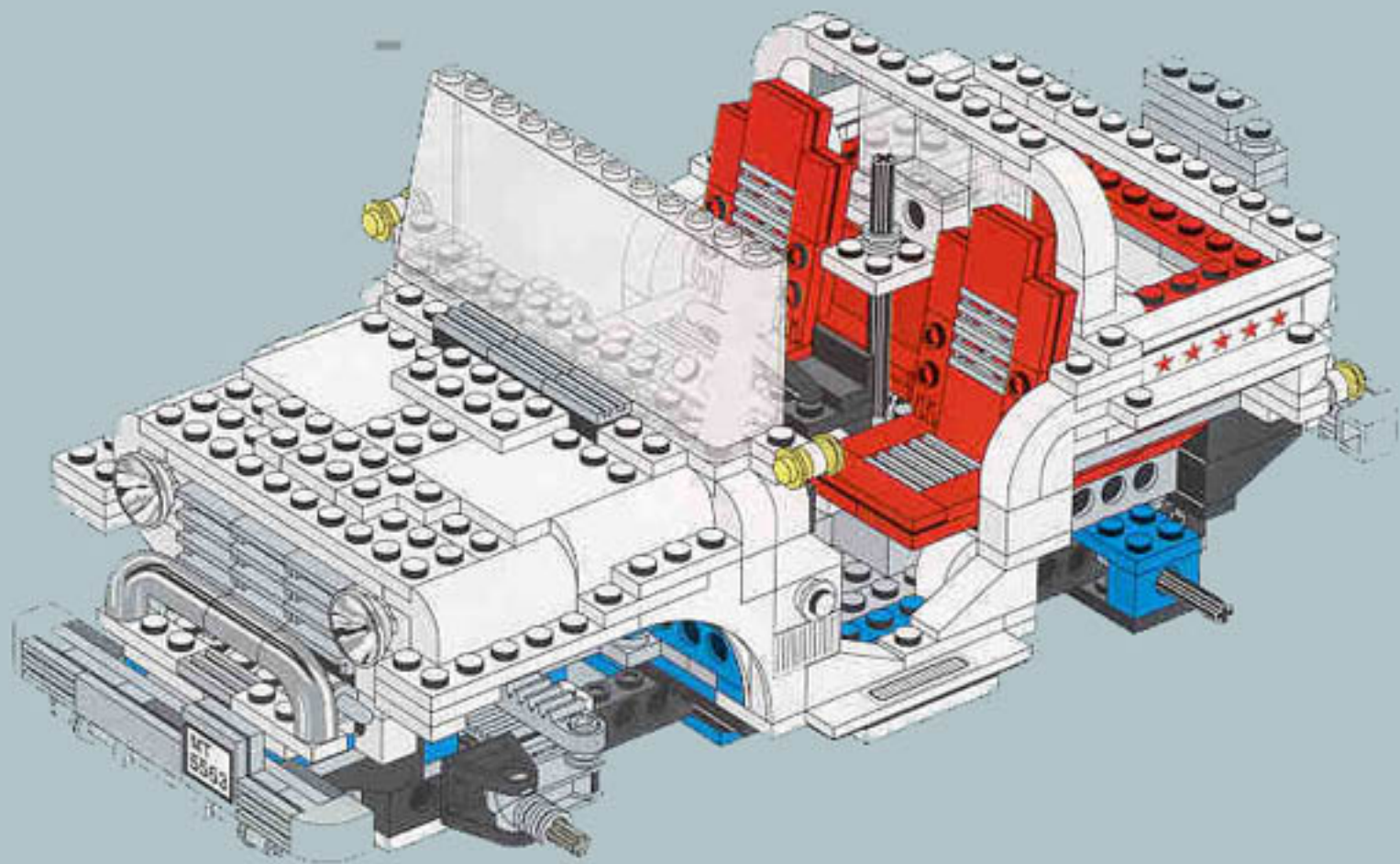

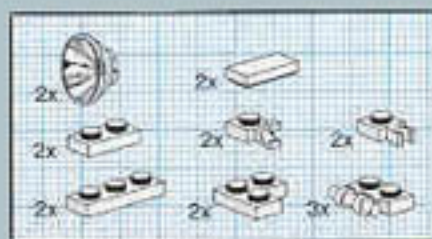

# 43

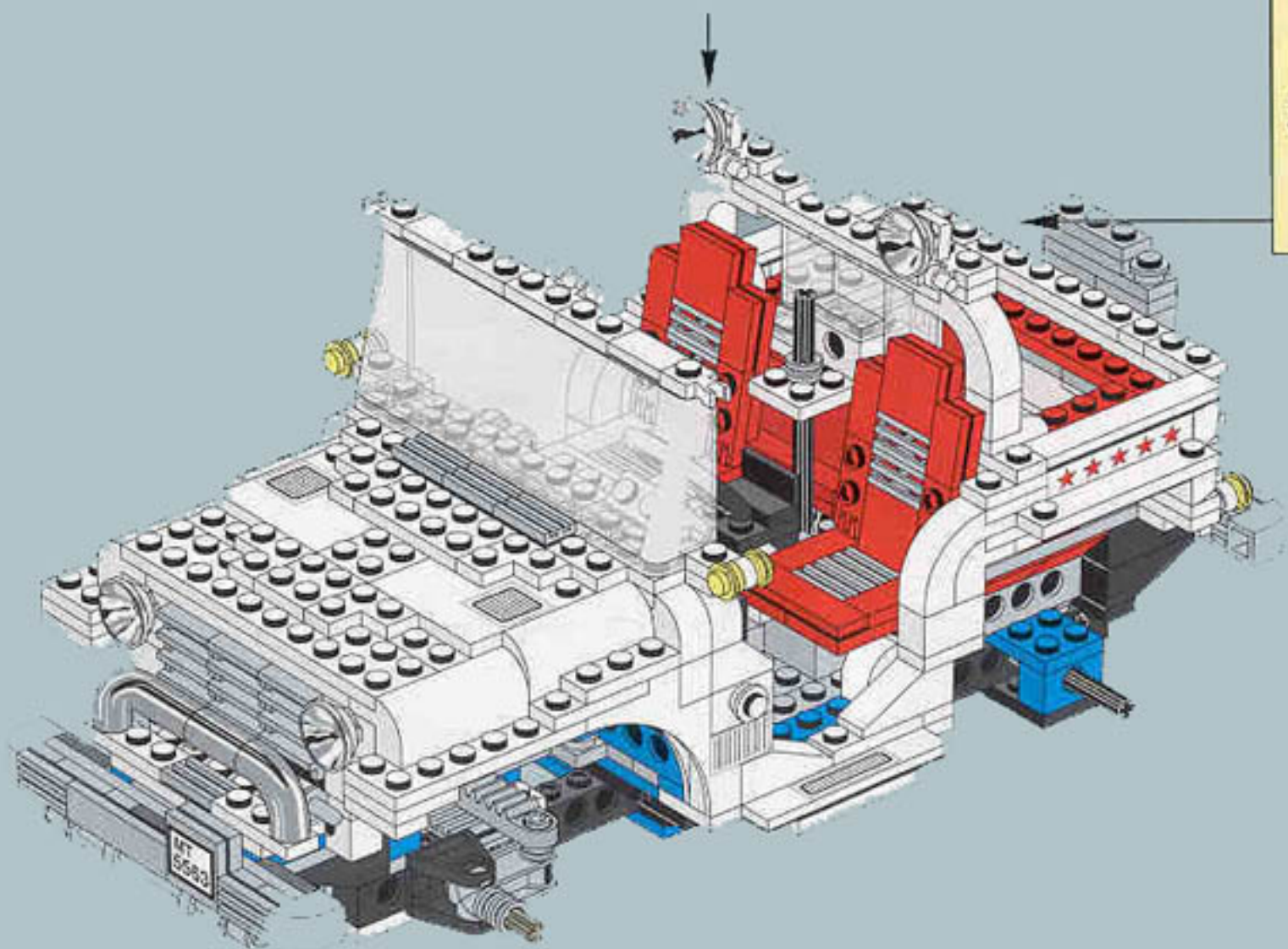
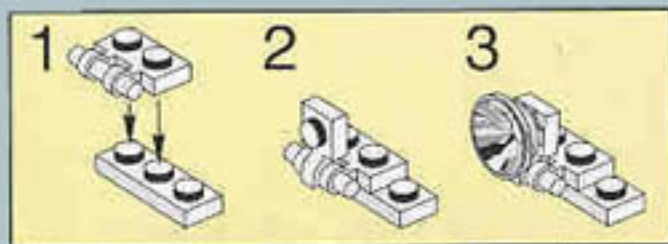



44

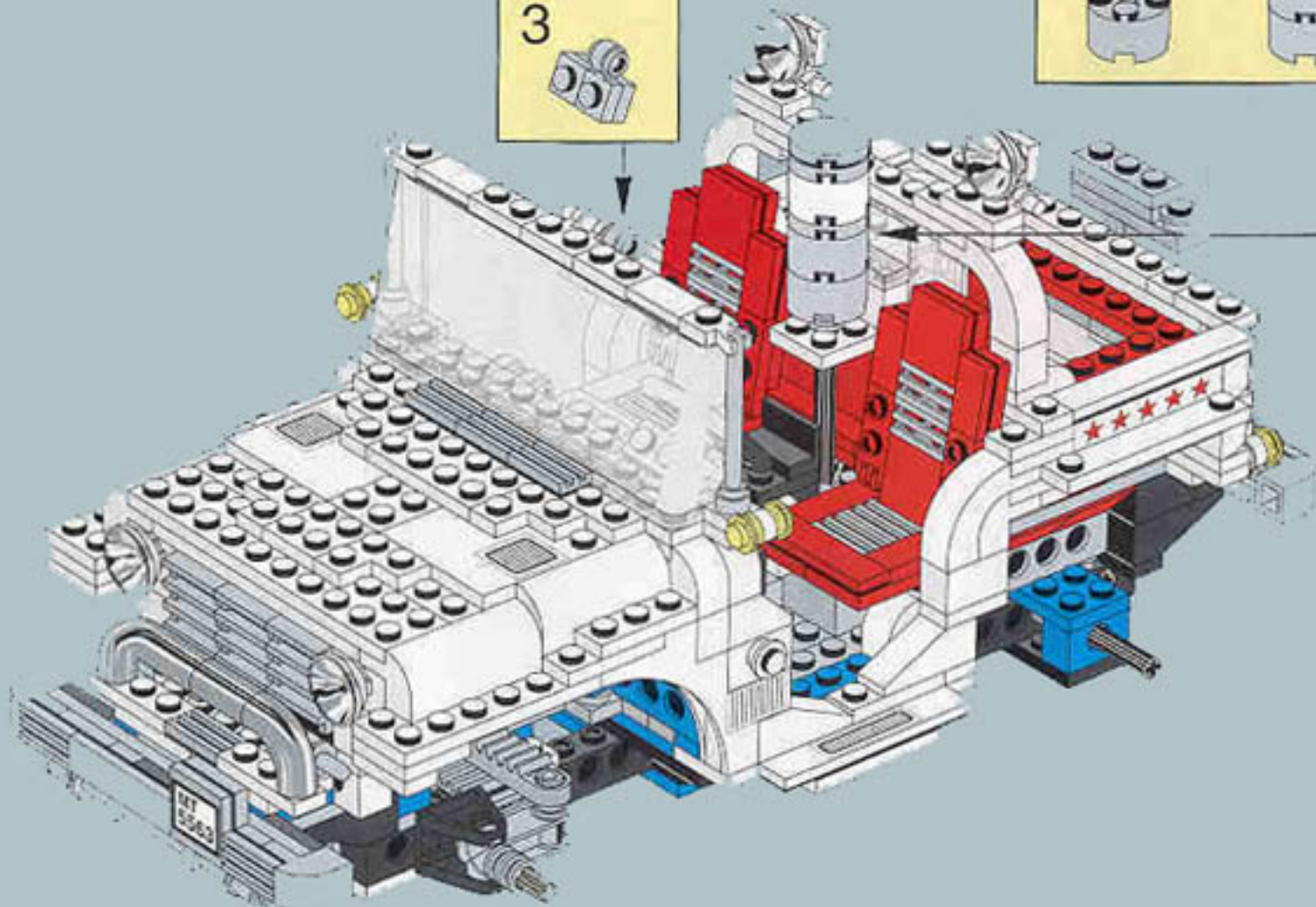
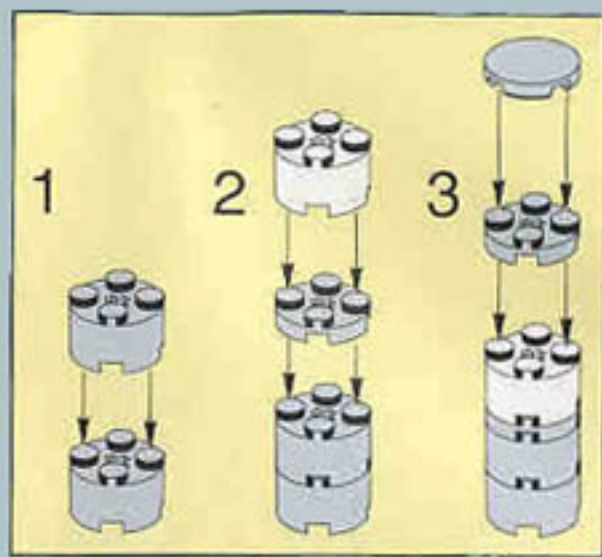



# 45

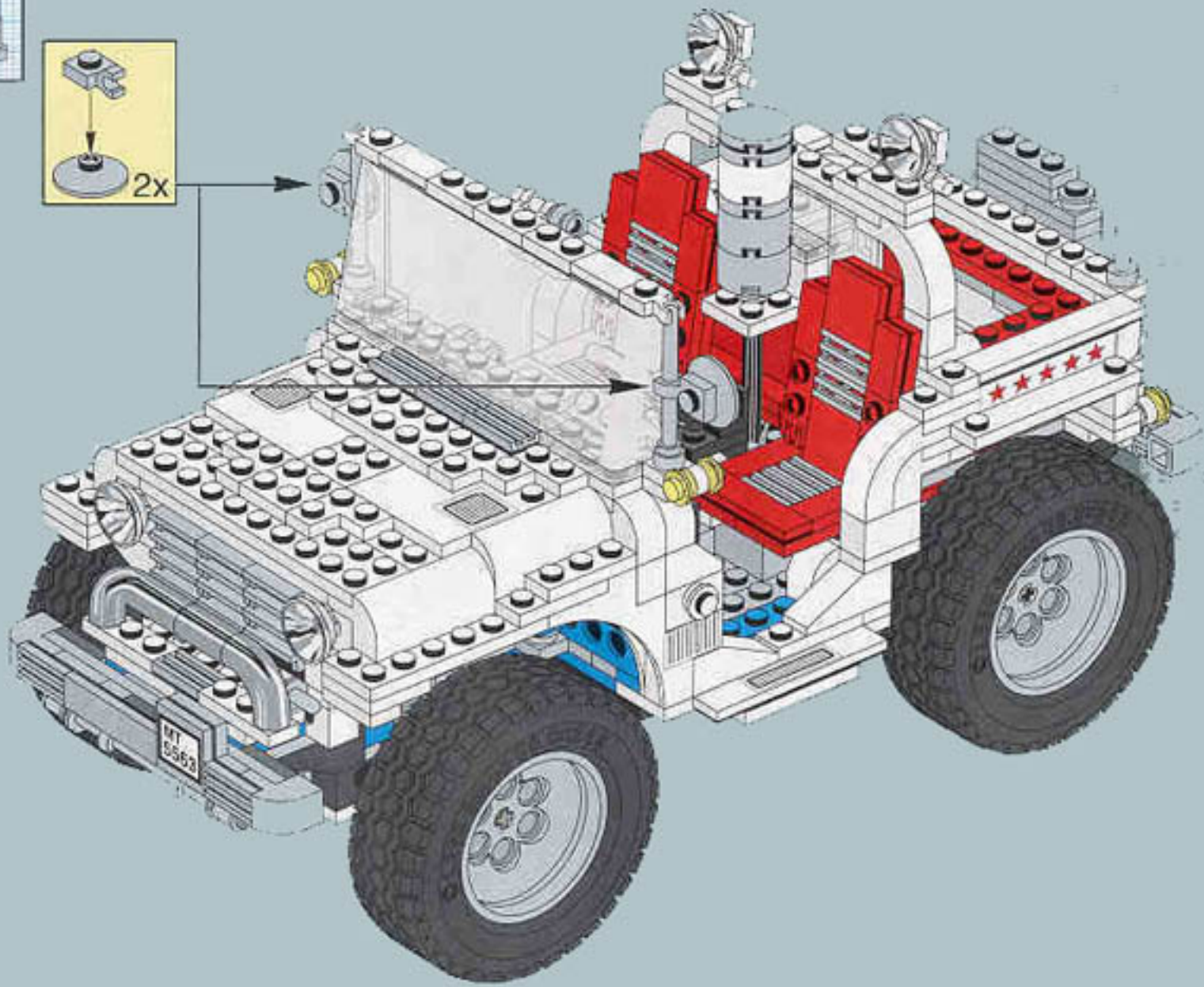
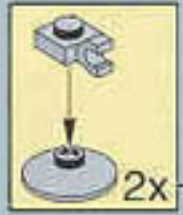



DIESEL POWER



DIESEL POWER

DIESEL  
POWER



DIESEL  
POWER

DIESEL  
POWER

Octan



Octan



Octan



Octan

DIESEL POWER



Octan

DIESEL POWER

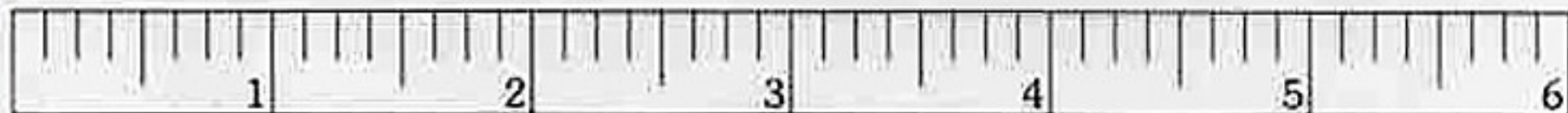











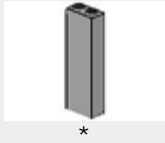

Image	Qty	Item No	Description	MID
<b>Regular Items:</b>				
<b>Parts:</b>				
+ 	3	<a href="#">3957</a>	<b>Light Gray Antenna 1 x 4</b> <a href="#">Catalog: Parts: Antenna</a>	<a href="#">PG</a>
+ 	1	<a href="#">2569</a>	<b>Light Gray Antenna Whip 8H</b> <a href="#">Catalog: Parts: Antenna</a>	<a href="#">PG</a>
+ 	2	<a href="#">2714a</a>	<b>Light Gray Bar 8L with Stop Rings and Pin (Technic, Figure Accessory Ski Pole) - Rounded End</b> <a href="#">Catalog: Parts: Bar</a>	<a href="#">PG</a>
+ 	2	<a href="#">2436</a>	<b>Light Gray Bracket 1 x 2 - 1 x 4</b> <a href="#">Catalog: Parts: Bracket</a>	<a href="#">PG</a>
+ 	2	<a href="#">3005</a>	<b>Light Gray Brick 1 x 1</b> <a href="#">Catalog: Parts: Brick</a>	<a href="#">PG</a>
+ 	14	<a href="#">3005</a>	<b>White Brick 1 x 1</b> <a href="#">Catalog: Parts: Brick</a>	<a href="#">PG</a>
+ 	5	<a href="#">3004</a>	<b>Black Brick 1 x 2</b> <a href="#">Catalog: Parts: Brick</a>	<a href="#">PG</a>
+ 	6	<a href="#">3004</a>	<b>Blue Brick 1 x 2</b> <a href="#">Catalog: Parts: Brick</a>	<a href="#">PG</a>
+ 	1	<a href="#">3004</a>	<b>Light Gray Brick 1 x 2</b> <a href="#">Catalog: Parts: Brick</a>	<a href="#">PG</a>
+ 	7	<a href="#">3004</a>	<b>Red Brick 1 x 2</b> <a href="#">Catalog: Parts: Brick</a>	<a href="#">PG</a>
+ 	3	<a href="#">3004</a>	<b>White Brick 1 x 2</b> <a href="#">Catalog: Parts: Brick</a>	<a href="#">PG</a>

+



1

[2454](#)

**Light Gray Brick 1 x 2 x 5 - Blocked Open Studs or Hollow Studs**

[PG](#)

[Catalog](#): [Parts](#): [Brick](#)

+



3

[3622](#)

**Black Brick 1 x 3**

[PG](#)

[Catalog](#): [Parts](#): [Brick](#)

+



3

[3010](#)

**White Brick 1 x 4**

[PG](#)

[Catalog](#): [Parts](#): [Brick](#)

+



1

[3009](#)

**Black Brick 1 x 6**

[PG](#)

[Catalog](#): [Parts](#): [Brick](#)

+



1

[3009](#)

**White Brick 1 x 6**

[PG](#)

[Catalog](#): [Parts](#): [Brick](#)

+



2

[6111](#)

**Light Gray Brick 1 x 10**

[PG](#)

[Catalog](#): [Parts](#): [Brick](#)

+



1

[3003](#)

**Blue Brick 2 x 2**

[PG](#)

[Catalog](#): [Parts](#): [Brick](#)

+



2

[3003](#)

**Light Gray Brick 2 x 2**

[PG](#)

[Catalog](#): [Parts](#): [Brick](#)

+



2

[2357](#)

**Black Brick 2 x 2 Corner**

[PG](#)

[Catalog](#): [Parts](#): [Brick](#)

+



2

[2357](#)

**Blue Brick 2 x 2 Corner**

[PG](#)

[Catalog](#): [Parts](#): [Brick](#)

+



1

[3002](#)

**Black Brick 2 x 3**

[PG](#)

[Catalog](#): [Parts](#): [Brick](#)

+



1

[2456](#)

**Black Brick 2 x 6**

[PG](#)

[Catalog](#): [Parts](#): [Brick](#)

+  4 [6005](#) **White Brick, Arch 1 x 3 x 2 Curved Top** [PG](#)  
[Catalog:](#) [Parts:](#) [Brick, Arch](#)

+  2 [2339](#) **White Brick, Arch 1 x 5 x 4 - Continuous Bow** [PG](#)  
[Catalog:](#) [Parts:](#) [Brick, Arch](#)

+  4 [4070](#) **White Brick, Modified 1 x 1 with Headlight** [PG](#)  
[Catalog:](#) [Parts:](#) [Brick, Modified](#)

+  2 [2458](#) **Light Gray Brick, Modified 1 x 2 with Pin** [PG](#)  
[Catalog:](#) [Parts:](#) [Brick, Modified](#)

+  2 [6091](#) **Blue Brick, Modified 1 x 2 x 1 1/3 with Curved Top** [PG](#)  
[Catalog:](#) [Parts:](#) [Brick, Modified](#)

+  9 [6091](#) **Light Gray Brick, Modified 1 x 2 x 1 1/3 with Curved Top** [PG](#)  
[Catalog:](#) [Parts:](#) [Brick, Modified](#)

+  14 [6091](#) **White Brick, Modified 1 x 2 x 1 1/3 with Curved Top** [PG](#)  
[Catalog:](#) [Parts:](#) [Brick, Modified](#)

+  4 [6081](#) **White Brick, Modified 2 x 4 x 1 1/3 with Curved Top** [PG](#)  
[Catalog:](#) [Parts:](#) [Brick, Modified](#)

+  2 [71075](#) **Chrome Silver Brick, Round 1 x 1 d. 90 Degree Elbow - No Stud - Type 1** [PG](#)  
[Catalog:](#) [Parts:](#) [Brick, Round](#)

+  4 [3062b](#) **Light Gray Brick, Round 1 x 1 Open Stud** [PG](#)  
[Catalog:](#) [Parts:](#) [Brick, Round](#)

+  2 [71076](#) **Chrome Silver Brick, Round 1 x 1 x 1 2/3** [PG](#)  
[Catalog:](#) [Parts:](#) [Brick, Round](#)

+  10 [3941](#) **Light Gray Brick, Round 2 x 2 with Axle Hole** [PG](#)  
[Catalog:](#) [Parts:](#) [Brick, Round](#)

+



\*

1

[3941](#)

**White Brick, Round 2 x 2 with Axle Hole**

[Catalog: Parts: Brick, Round](#)

[PG](#)

+



\*

10

[3063](#)

**Red Brick, Round Corner 2 x 2 Macaroni with Stud Notch**

[Catalog: Parts: Brick, Round](#)

[PG](#)

+



\*

12

[3063](#)

**White Brick, Round Corner 2 x 2 Macaroni with Stud Notch**

[Catalog: Parts: Brick, Round](#)

[PG](#)

+



\*

2

[4740](#)

**Light Gray Dish 2 x 2 Inverted (Radar)**

[Catalog: Parts: Dish](#)

[PG](#)

+



\*

4

[x85](#)

**Chrome Silver Dish 2 x 2 x 2/3 Light Reflector**

[Catalog: Parts: Dish](#)

[PG](#)

+

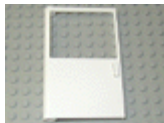

\*

1

[30073](#)

**White Door 1 x 6 x 8 Left**

[Catalog: Parts: Door](#)

[PG](#)

+



\*

1

[30074](#)

**White Door 1 x 6 x 8 Right**

[Catalog: Parts: Door](#)

[PG](#)

+



\*

2

[2335](#)

**Red Flag 2 x 2 Square**

[Catalog: Parts: Flag](#)

[PG](#)

+



\*

1

[3937](#)

**Black Hinge Brick 1 x 2 Base**

[Catalog: Parts: Hinge](#)

[PG](#)

+



\*

2

[3937](#)

**Light Gray Hinge Brick 1 x 2 Base**

[Catalog: Parts: Hinge](#)

[PG](#)

+



\*

2

[3938](#)

**Blue Hinge Brick 1 x 2 Top**

[Catalog: Parts: Hinge](#)

[PG](#)

+



\*













1

[3938](#)

**Light Gray Hinge Brick 1 x 2 Top**

[Catalog: Parts: Hinge](#)

[PG](#)

+	 *	4	<a href="#">4275</a>	<b>Red Hinge Plate 1 x 2 with 3 Fingers</b> <a href="#">Catalog:</a> <a href="#">Parts:</a> <a href="#">Hinge</a>	<a href="#">PG</a>
+	 *	4	<a href="#">4531</a>	<b>Red Hinge Tile 1 x 2 1/2 with 2 Fingers on Top</b> <a href="#">Catalog:</a> <a href="#">Parts:</a> <a href="#">Hinge</a>	<a href="#">PG</a>
+	 *	2	<a href="#">78c02</a>	<b>Black Hose, Ribbed 7mm D. 2L</b> <a href="#">Catalog:</a> <a href="#">Parts:</a> <a href="#">Hose, Ribbed 7mm D.</a>	<a href="#">PG</a>
+	 *	2	<a href="#">78c06</a>	<b>Black Hose, Ribbed 7mm D. 6L</b> <a href="#">Catalog:</a> <a href="#">Parts:</a> <a href="#">Hose, Ribbed 7mm D.</a>	<a href="#">PG</a>
+	 *	3	<a href="#">4592c03</a> (inv)	<b>Light Gray Lever Small Base with Light Gray Lever</b> <a href="#">Catalog:</a> <a href="#">Parts:</a> <a href="#">Lever</a>	<a href="#">PG</a>
+	 *	2	<a href="#">3849</a>	<b>Light Gray Minifigure, Weapon Lance</b> <a href="#">Catalog:</a> <a href="#">Parts:</a> <a href="#">Minifigure, Weapon</a>	<a href="#">PG</a>
+	 *	2	<a href="#">6231</a>	<b>Light Gray Panel 1 x 1 x 1 Corner</b> <a href="#">Catalog:</a> <a href="#">Parts:</a> <a href="#">Panel</a>	<a href="#">PG</a>
+	 *	2	<a href="#">4865</a>	<b>Black Panel 1 x 2 x 1</b> <a href="#">Catalog:</a> <a href="#">Parts:</a> <a href="#">Panel</a>	<a href="#">PG</a>
+	 *	2	<a href="#">4864b</a>	<b>Red Panel 1 x 2 x 2 - Hollow Studs</b> <a href="#">Catalog:</a> <a href="#">Parts:</a> <a href="#">Panel</a>	<a href="#">PG</a>
+	 *	4	<a href="#">4864b</a>	<b>Trans-Clear Panel 1 x 2 x 2 - Hollow Studs</b> <a href="#">Catalog:</a> <a href="#">Parts:</a> <a href="#">Panel</a>	<a href="#">PG</a>
+	 *	4	<a href="#">4864b</a>	<b>White Panel 1 x 2 x 2 - Hollow Studs</b> <a href="#">Catalog:</a> <a href="#">Parts:</a> <a href="#">Panel</a>	<a href="#">PG</a>
+	 *	2	<a href="#">2362a</a>	<b>Trans-Clear Panel 1 x 2 x 3 - Solid Studs</b> <a href="#">Catalog:</a> <a href="#">Parts:</a> <a href="#">Panel</a>	<a href="#">PG</a>

+		2	<a href="#">4215b</a>	<b>Red Panel 1 x 4 x 3 - Hollow Studs</b> <a href="#">Catalog: Parts: Panel</a>	<a href="#">PG</a>
---	--	---	-----------------------	--	--------------------

+		2	<a href="#">3024</a>	<b>Light Gray Plate 1 x 1</b> <a href="#">Catalog: Parts: Plate</a>	<a href="#">PG</a>
---	---	---	----------------------	--	--------------------

+		2	<a href="#">3024</a>	<b>Red Plate 1 x 1</b> <a href="#">Catalog: Parts: Plate</a>	<a href="#">PG</a>
---	---	---	----------------------	---	--------------------

+		12	<a href="#">3024</a>	<b>White Plate 1 x 1</b> <a href="#">Catalog: Parts: Plate</a>	<a href="#">PG</a>
---	---	----	----------------------	---	--------------------

+		16	<a href="#">3023</a>	<b>Black Plate 1 x 2</b> <a href="#">Catalog: Parts: Plate</a>	<a href="#">PG</a>
---	---	----	----------------------	---	--------------------

+		3	<a href="#">3023</a>	<b>Blue Plate 1 x 2</b> <a href="#">Catalog: Parts: Plate</a>	<a href="#">PG</a>
---	--	---	----------------------	--	--------------------

+		12	<a href="#">3023</a>	<b>Light Gray Plate 1 x 2</b> <a href="#">Catalog: Parts: Plate</a>	<a href="#">PG</a>
---	---	----	----------------------	--	--------------------

+		2	<a href="#">3023</a>	<b>Red Plate 1 x 2</b> <a href="#">Catalog: Parts: Plate</a>	<a href="#">PG</a>
---	---	---	----------------------	---	--------------------

+		19	<a href="#">3023</a>	<b>White Plate 1 x 2</b> <a href="#">Catalog: Parts: Plate</a>	<a href="#">PG</a>
---	---	----	----------------------	---	--------------------

+		2	<a href="#">3023</a>	<b>Yellow Plate 1 x 2</b> <a href="#">Catalog: Parts: Plate</a>	<a href="#">PG</a>
---	---	---	----------------------	--	--------------------

+		2	<a href="#">3623</a>	<b>Black Plate 1 x 3</b> <a href="#">Catalog: Parts: Plate</a>	<a href="#">PG</a>
---	---	---	----------------------	---	--------------------

+		4	<a href="#">3623</a>	<b>Blue Plate 1 x 3</b> <a href="#">Catalog: Parts: Plate</a>	<a href="#">PG</a>
---	---	---	----------------------	--	--------------------

+		4	<a href="#">3623</a>	<b>Light Gray Plate 1 x 3</b> <a href="#">Catalog:</a> <a href="#">Parts:</a> <a href="#">Plate</a>	<a href="#">PG</a>
---	--	---	----------------------	--	--------------------

+		14	<a href="#">3623</a>	<b>White Plate 1 x 3</b> <a href="#">Catalog:</a> <a href="#">Parts:</a> <a href="#">Plate</a>	<a href="#">PG</a>
---	---	----	----------------------	---	--------------------

+		4	<a href="#">3710</a>	<b>Black Plate 1 x 4</b> <a href="#">Catalog:</a> <a href="#">Parts:</a> <a href="#">Plate</a>	<a href="#">PG</a>
---	---	---	----------------------	---	--------------------

+		4	<a href="#">3710</a>	<b>Blue Plate 1 x 4</b> <a href="#">Catalog:</a> <a href="#">Parts:</a> <a href="#">Plate</a>	<a href="#">PG</a>
---	---	---	----------------------	--	--------------------

+		3	<a href="#">3710</a>	<b>Light Gray Plate 1 x 4</b> <a href="#">Catalog:</a> <a href="#">Parts:</a> <a href="#">Plate</a>	<a href="#">PG</a>
---	---	---	----------------------	--	--------------------

+		6	<a href="#">3710</a>	<b>White Plate 1 x 4</b> <a href="#">Catalog:</a> <a href="#">Parts:</a> <a href="#">Plate</a>	<a href="#">PG</a>
---	--	---	----------------------	---	--------------------

+		2	<a href="#">3666</a>	<b>Black Plate 1 x 6</b> <a href="#">Catalog:</a> <a href="#">Parts:</a> <a href="#">Plate</a>	<a href="#">PG</a>
---	---	---	----------------------	---	--------------------

+		1	<a href="#">3666</a>	<b>Blue Plate 1 x 6</b> <a href="#">Catalog:</a> <a href="#">Parts:</a> <a href="#">Plate</a>	<a href="#">PG</a>
---	---	---	----------------------	--	--------------------

+		4	<a href="#">3666</a>	<b>Light Gray Plate 1 x 6</b> <a href="#">Catalog:</a> <a href="#">Parts:</a> <a href="#">Plate</a>	<a href="#">PG</a>
---	---	---	----------------------	--	--------------------

+		1	<a href="#">3666</a>	<b>Red Plate 1 x 6</b> <a href="#">Catalog:</a> <a href="#">Parts:</a> <a href="#">Plate</a>	<a href="#">PG</a>
---	---	---	----------------------	---	--------------------

+		7	<a href="#">3666</a>	<b>White Plate 1 x 6</b> <a href="#">Catalog:</a> <a href="#">Parts:</a> <a href="#">Plate</a>	<a href="#">PG</a>
---	---	---	----------------------	---	--------------------

+		1	<a href="#">3460</a>	<b>Black Plate 1 x 8</b> <a href="#">Catalog:</a> <a href="#">Parts:</a> <a href="#">Plate</a>	<a href="#">PG</a>
---	---	---	----------------------	---	--------------------



+		6	<a href="#">3460</a>	<b>Light Gray Plate 1 x 8</b> <a href="#">Catalog:</a> <a href="#">Parts:</a> <a href="#">Plate</a>	<a href="#">PG</a>
---	--	---	----------------------	--	--------------------

\*

+		4	<a href="#">3460</a>	<b>White Plate 1 x 8</b> <a href="#">Catalog:</a> <a href="#">Parts:</a> <a href="#">Plate</a>	<a href="#">PG</a>
---	---	---	----------------------	---	--------------------

\*

+		1	<a href="#">4477</a>	<b>Black Plate 1 x 10</b> <a href="#">Catalog:</a> <a href="#">Parts:</a> <a href="#">Plate</a>	<a href="#">PG</a>
---	---	---	----------------------	--	--------------------

\*

+		4	<a href="#">4477</a>	<b>Light Gray Plate 1 x 10</b> <a href="#">Catalog:</a> <a href="#">Parts:</a> <a href="#">Plate</a>	<a href="#">PG</a>
---	---	---	----------------------	---	--------------------

\*

+		1	<a href="#">4477</a>	<b>Red Plate 1 x 10</b> <a href="#">Catalog:</a> <a href="#">Parts:</a> <a href="#">Plate</a>	<a href="#">PG</a>
---	---	---	----------------------	--	--------------------

\*

+		3	<a href="#">4477</a>	<b>White Plate 1 x 10</b> <a href="#">Catalog:</a> <a href="#">Parts:</a> <a href="#">Plate</a>	<a href="#">PG</a>
---	--	---	----------------------	--	--------------------

\*

+		4	<a href="#">3022</a>	<b>Black Plate 2 x 2</b> <a href="#">Catalog:</a> <a href="#">Parts:</a> <a href="#">Plate</a>	<a href="#">PG</a>
---	---	---	----------------------	---	--------------------

\*

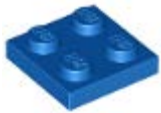
+		7	<a href="#">3022</a>	<b>Blue Plate 2 x 2</b> <a href="#">Catalog:</a> <a href="#">Parts:</a> <a href="#">Plate</a>	<a href="#">PG</a>
---	---	---	----------------------	--	--------------------

\*

+		4	<a href="#">3022</a>	<b>Light Gray Plate 2 x 2</b> <a href="#">Catalog:</a> <a href="#">Parts:</a> <a href="#">Plate</a>	<a href="#">PG</a>
---	---	---	----------------------	--	--------------------

\*

+		2	<a href="#">3022</a>	<b>Red Plate 2 x 2</b> <a href="#">Catalog:</a> <a href="#">Parts:</a> <a href="#">Plate</a>	<a href="#">PG</a>
---	---	---	----------------------	---	--------------------

\*

+		9	<a href="#">3022</a>	<b>White Plate 2 x 2</b> <a href="#">Catalog:</a> <a href="#">Parts:</a> <a href="#">Plate</a>	<a href="#">PG</a>
---	---	---	----------------------	---	--------------------

\*

+		2	<a href="#">2420</a>	<b>Black Plate 2 x 2 Corner</b> <a href="#">Catalog:</a> <a href="#">Parts:</a> <a href="#">Plate</a>	<a href="#">PG</a>
---	---	---	----------------------	--	--------------------

\*

+		9	<a href="#">2420</a>	<b>Light Gray Plate 2 x 2 Corner</b> <a href="#">Catalog: Parts: Plate</a>	<a href="#">PG</a>
---	--	---	----------------------	---	--------------------

+		23	<a href="#">2420</a>	<b>White Plate 2 x 2 Corner</b> <a href="#">Catalog: Parts: Plate</a>	<a href="#">PG</a>
---	---	----	----------------------	--	--------------------

+		3	<a href="#">3021</a>	<b>Light Gray Plate 2 x 3</b> <a href="#">Catalog: Parts: Plate</a>	<a href="#">PG</a>
---	---	---	----------------------	--	--------------------

+		7	<a href="#">3021</a>	<b>Red Plate 2 x 3</b> <a href="#">Catalog: Parts: Plate</a>	<a href="#">PG</a>
---	---	---	----------------------	---	--------------------

+		10	<a href="#">3021</a>	<b>White Plate 2 x 3</b> <a href="#">Catalog: Parts: Plate</a>	<a href="#">PG</a>
---	---	----	----------------------	---	--------------------

+		2	<a href="#">3020</a>	<b>Black Plate 2 x 4</b> <a href="#">Catalog: Parts: Plate</a>	<a href="#">PG</a>
---	--	---	----------------------	---	--------------------

+		3	<a href="#">3020</a>	<b>Light Gray Plate 2 x 4</b> <a href="#">Catalog: Parts: Plate</a>	<a href="#">PG</a>
---	---	---	----------------------	--	--------------------

+		1	<a href="#">3020</a>	<b>Red Plate 2 x 4</b> <a href="#">Catalog: Parts: Plate</a>	<a href="#">PG</a>
---	---	---	----------------------	---	--------------------

+		4	<a href="#">3020</a>	<b>White Plate 2 x 4</b> <a href="#">Catalog: Parts: Plate</a>	<a href="#">PG</a>
---	---	---	----------------------	---	--------------------

+		3	<a href="#">3795</a>	<b>White Plate 2 x 6</b> <a href="#">Catalog: Parts: Plate</a>	<a href="#">PG</a>
---	---	---	----------------------	---	--------------------

+		1	<a href="#">3034</a>	<b>Black Plate 2 x 8</b> <a href="#">Catalog: Parts: Plate</a>	<a href="#">PG</a>
---	---	---	----------------------	---	--------------------

+		2	<a href="#">3034</a>	<b>White Plate 2 x 8</b> <a href="#">Catalog: Parts: Plate</a>	<a href="#">PG</a>
---	---	---	----------------------	---	--------------------

+		5	<a href="#">3832</a>	<b>Black Plate 2 x 10</b> <a href="#">Catalog: Parts: Plate</a>	<a href="#">PG</a>
---	--	---	----------------------	--	--------------------

+		1	<a href="#">3832</a>	<b>Red Plate 2 x 10</b> <a href="#">Catalog: Parts: Plate</a>	<a href="#">PG</a>
---	---	---	----------------------	--	--------------------

+		3	<a href="#">3832</a>	<b>White Plate 2 x 10</b> <a href="#">Catalog: Parts: Plate</a>	<a href="#">PG</a>
---	---	---	----------------------	--	--------------------

+		1	<a href="#">2445</a>	<b>Black Plate 2 x 12</b> <a href="#">Catalog: Parts: Plate</a>	<a href="#">PG</a>
---	---	---	----------------------	--	--------------------

+		1	<a href="#">2445</a>	<b>Blue Plate 2 x 12</b> <a href="#">Catalog: Parts: Plate</a>	<a href="#">PG</a>
---	---	---	----------------------	---	--------------------

+		1	<a href="#">2445</a>	<b>White Plate 2 x 12</b> <a href="#">Catalog: Parts: Plate</a>	<a href="#">PG</a>
---	---	---	----------------------	--	--------------------

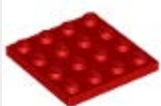
+		2	<a href="#">3031</a>	<b>Red Plate 4 x 4</b> <a href="#">Catalog: Parts: Plate</a>	<a href="#">PG</a>
---	---	---	----------------------	---	--------------------













+		1	<a href="#">3032</a>	<b>Light Gray Plate 4 x 6</b> <a href="#">Catalog: Parts: Plate</a>	<a href="#">PG</a>
---	---	---	----------------------	--	--------------------













+		2	<a href="#">3032</a>	<b>White Plate 4 x 6</b> <a href="#">Catalog: Parts: Plate</a>	<a href="#">PG</a>
---	---	---	----------------------	---	--------------------











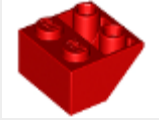

+		6	<a href="#">6019</a>	<b>Light Gray Plate, Modified 1 x 1 with Clip Horizontal (thick open U clip)</b> <a href="#">Catalog: Parts: Plate, Modified</a>	<a href="#">PG</a>
---	---	---	----------------------	---	--------------------

+		2	<a href="#">6019</a>	<b>White Plate, Modified 1 x 1 with Clip Horizontal (thick open U clip)</b> <a href="#">Catalog: Parts: Plate, Modified</a>	<a href="#">PG</a>
---	---	---	----------------------	--	--------------------







+		7	<a href="#">4081b</a>	<b>Light Gray Plate, Modified 1 x 1 with Clip Light - Thick Ring</b> <a href="#">Catalog: Parts: Plate, Modified</a>	<a href="#">PG</a>
---	---	---	-----------------------	---	--------------------

+	 *	4	<a href="#">4081b</a>	<b>White Plate, Modified 1 x 1 with Clip Light - Thick Ring</b> <a href="#">Catalog: Parts: Plate, Modified</a>	<a href="#">PG</a>
+	 *	4	<a href="#">4085c</a>	<b>Light Gray Plate, Modified 1 x 1 with Clip Vertical - Type 3 (thick U clip)</b> <a href="#">Catalog: Parts: Plate, Modified</a>	<a href="#">PG</a>
+	 *	6	<a href="#">4085c</a>	<b>White Plate, Modified 1 x 1 with Clip Vertical - Type 3 (thick U clip)</b> <a href="#">Catalog: Parts: Plate, Modified</a>	<a href="#">PG</a>
+	 *	3	<a href="#">2540</a>	<b>Light Gray Plate, Modified 1 x 2 with Handle on Side - Free Ends</b> <a href="#">Catalog: Parts: Plate, Modified</a>	<a href="#">PG</a>
+	 *	3	<a href="#">2540</a>	<b>White Plate, Modified 1 x 2 with Handle on Side - Free Ends</b> <a href="#">Catalog: Parts: Plate, Modified</a>	<a href="#">PG</a>
+	 *	11	<a href="#">4175</a>	<b>Light Gray Plate, Modified 1 x 2 with Ladder</b> <a href="#">Catalog: Parts: Plate, Modified</a>	<a href="#">PG</a>
+	 *	4	<a href="#">2444</a>	<b>Black Plate, Modified 2 x 2 with Pin Hole</b> <a href="#">Catalog: Parts: Plate, Modified</a>	<a href="#">PG</a>
+	 *	2	<a href="#">2444</a>	<b>Light Gray Plate, Modified 2 x 2 with Pin Hole</b> <a href="#">Catalog: Parts: Plate, Modified</a>	<a href="#">PG</a>
+	 *	4	<a href="#">4073</a>	<b>Black Plate, Round 1 x 1</b> <a href="#">Catalog: Parts: Plate, Round</a>	<a href="#">PG</a>
+	 *	17	<a href="#">4073</a>	<b>Light Gray Plate, Round 1 x 1</b> <a href="#">Catalog: Parts: Plate, Round</a>	<a href="#">PG</a>
+	 *	4	<a href="#">4073</a>	<b>Trans-Red Plate, Round 1 x 1</b> <a href="#">Catalog: Parts: Plate, Round</a>	<a href="#">PG</a>
+	 *	16	<a href="#">4073</a>	<b>Trans-Yellow Plate, Round 1 x 1</b> <a href="#">Catalog: Parts: Plate, Round</a>	<a href="#">PG</a>











+	 *	2	<a href="#">4073</a>	<b>White Plate, Round 1 x 1</b> <a href="#">Catalog: Parts: Plate, Round</a>	<a href="#">PG</a>
+	 *	4	<a href="#">4032</a>	<b>Light Gray Plate, Round 2 x 2 with Axle Hole</b> <a href="#">Catalog: Parts: Plate, Round</a>	<a href="#">PG</a>
+	 *	2	<a href="#">6003</a>	<b>White Plate, Round Corner 6 x 6</b> <a href="#">Catalog: Parts: Plate, Round</a>	<a href="#">PG</a>
+	 *	4	<a href="#">4286</a>	<b>White Slope 33 3 x 1</b> <a href="#">Catalog: Parts: Slope</a>	<a href="#">PG</a>
+	 *	2	<a href="#">3298</a>	<b>Red Slope 33 3 x 2</b> <a href="#">Catalog: Parts: Slope</a>	<a href="#">PG</a>
+	 *	1	<a href="#">3939</a>	<b>White Slope 33 3 x 6 with Inner Walls</b> <a href="#">Catalog: Parts: Slope</a>	<a href="#">PG</a>
+	 *	2	<a href="#">3040</a>	<b>Black Slope 45 2 x 1</b> <a href="#">Catalog: Parts: Slope</a>	<a href="#">PG</a>
+	 *	2	<a href="#">3040</a>	<b>Blue Slope 45 2 x 1</b> <a href="#">Catalog: Parts: Slope</a>	<a href="#">PG</a>
+	 *	2	<a href="#">3040</a>	<b>White Slope 45 2 x 1</b> <a href="#">Catalog: Parts: Slope</a>	<a href="#">PG</a>
+	 *	1	<a href="#">3039px6</a>	<b>Black Slope 45 2 x 2 with 3 Gauges and 3 Knobs Pattern</b> <a href="#">Catalog: Parts: Slope, Decorated</a>	<a href="#">PG</a>
+	 *	8	<a href="#">4287</a>	<b>Black Slope, Inverted 33 3 x 1</b> <a href="#">Catalog: Parts: Slope, Inverted</a>	<a href="#">PG</a>
+	 *	2	<a href="#">4287</a>	<b>White Slope, Inverted 33 3 x 1</b> <a href="#">Catalog: Parts: Slope, Inverted</a>	<a href="#">PG</a>





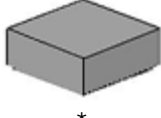



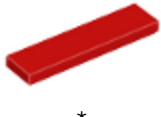

+	 *	3	<a href="#">3747a</a>	<b>Black Slope, Inverted 33 3 x 2 without Connections between Studs</b> <a href="#">Catalog: Parts: Slope, Inverted</a>	<a href="#">PG</a>
+	 *	1	<a href="#">3747a</a>	<b>White Slope, Inverted 33 3 x 2 without Connections between Studs</b> <a href="#">Catalog: Parts: Slope, Inverted</a>	<a href="#">PG</a>
+	 *	1	<a href="#">3665</a>	<b>Light Gray Slope, Inverted 45 2 x 1</b> <a href="#">Catalog: Parts: Slope, Inverted</a>	<a href="#">PG</a>
+	 *	3	<a href="#">3660</a>	<b>Black Slope, Inverted 45 2 x 2</b> <a href="#">Catalog: Parts: Slope, Inverted</a>	<a href="#">PG</a>
+	 *	4	<a href="#">3660</a>	<b>Red Slope, Inverted 45 2 x 2</b> <a href="#">Catalog: Parts: Slope, Inverted</a>	<a href="#">PG</a>
+	 *	4	<a href="#">4854</a>	<b>White Slope, Inverted 45 4 x 4 Double</b> <a href="#">Catalog: Parts: Slope, Inverted</a>	<a href="#">PG</a>
+	 *	1	<a href="#">5563stk01</a>	<b>Sticker for Set 5563 - (72703/4121723)</b> <a href="#">Catalog: Parts: Sticker</a>	<a href="#">PG</a>
+	 *	2	<a href="#">4599a</a>	<b>Blue Tap 1 x 1 with Hole in Nozzle End</b> <a href="#">Catalog: Parts: Tap</a>	<a href="#">PG</a>
+	 *	1	<a href="#">4599a</a>	<b>Light Gray Tap 1 x 1 with Hole in Nozzle End</b> <a href="#">Catalog: Parts: Tap</a>	<a href="#">PG</a>
+	 *	8	<a href="#">3713</a>	<b>Light Gray Technic Bush</b> <a href="#">Catalog: Parts: Technic</a>	<a href="#">PG</a>
+	 *	6	<a href="#">4265c</a>	<b>Light Gray Technic Bush 1/2 Smooth</b> <a href="#">Catalog: Parts: Technic</a>	<a href="#">PG</a>
+	 *	1	<a href="#">4185</a>	<b>Light Gray Technic Wedge Belt Wheel (Pulley)</b> <a href="#">Catalog: Parts: Technic</a>	<a href="#">PG</a>

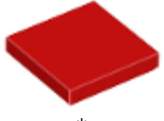
+		1	<a href="#">2815</a>	<b>Black Technic Wedge Belt Wheel Tire</b> <a href="#">Catalog: Parts: Technic</a>	<a href="#">PG</a>
+		2	<a href="#">32062</a>	<b>Black Technic, Axle 2 Notched</b> <a href="#">Catalog: Parts: Technic, Axle</a>	<a href="#">PG</a>
+		2	<a href="#">6587</a>	<b>Dark Gray Technic, Axle 3 with Stud</b> <a href="#">Catalog: Parts: Technic, Axle</a>	<a href="#">PG</a>
+		4	<a href="#">3705</a>	<b>Black Technic, Axle 4</b> <a href="#">Catalog: Parts: Technic, Axle</a>	<a href="#">PG</a>
+		1	<a href="#">3706</a>	<b>Black Technic, Axle 6</b> <a href="#">Catalog: Parts: Technic, Axle</a>	<a href="#">PG</a>
+		3	<a href="#">3707</a>	<b>Black Technic, Axle 8</b> <a href="#">Catalog: Parts: Technic, Axle</a>	<a href="#">PG</a>
+		8	<a href="#">32013</a>	<b>Light Gray Technic, Axle and Pin Connector Angled #1</b> <a href="#">Catalog: Parts: Technic, Connector</a>	<a href="#">PG</a>
+		2	<a href="#">32068</a>	<b>Light Gray Technic, Axle and Pin Connector Perpendicular 3L with Pin Hole</b> <a href="#">Catalog: Parts: Technic, Connector</a>	<a href="#">PG</a>
+		5	<a href="#">3749</a>	<b>Light Gray Technic, Axle Pin without Friction Ridges Lengthwise</b> <a href="#">Catalog: Parts: Technic, Axle</a>	<a href="#">PG</a>
+		1	<a href="#">3700</a>	<b>Black Technic, Brick 1 x 2 with Hole</b> <a href="#">Catalog: Parts: Technic, Brick</a>	<a href="#">PG</a>
+		2	<a href="#">3700</a>	<b>Blue Technic, Brick 1 x 2 with Hole</b> <a href="#">Catalog: Parts: Technic, Brick</a>	<a href="#">PG</a>
+		2	<a href="#">3700</a>	<b>Red Technic, Brick 1 x 2 with Hole</b> <a href="#">Catalog: Parts: Technic, Brick</a>	<a href="#">PG</a>

+	 *	10	<a href="#">3700</a>	<b>White Technic, Brick 1 x 2 with Hole</b> <a href="#">Catalog: Parts: Technic, Brick</a>	<a href="#">PG</a>
+	 *	4	<a href="#">3701</a>	<b>Black Technic, Brick 1 x 4 with Holes</b> <a href="#">Catalog: Parts: Technic, Brick</a>	<a href="#">PG</a>
+	 *	2	<a href="#">3701</a>	<b>Blue Technic, Brick 1 x 4 with Holes</b> <a href="#">Catalog: Parts: Technic, Brick</a>	<a href="#">PG</a>
+	 *	2	<a href="#">3701</a>	<b>Light Gray Technic, Brick 1 x 4 with Holes</b> <a href="#">Catalog: Parts: Technic, Brick</a>	<a href="#">PG</a>
+	 *	2	<a href="#">3701</a>	<b>White Technic, Brick 1 x 4 with Holes</b> <a href="#">Catalog: Parts: Technic, Brick</a>	<a href="#">PG</a>
+	 *	2	<a href="#">2730</a>	<b>Black Technic, Brick 1 x 10 with Holes</b> <a href="#">Catalog: Parts: Technic, Brick</a>	<a href="#">PG</a>
+	 *	2	<a href="#">3703</a>	<b>Black Technic, Brick 1 x 16 with Holes</b> <a href="#">Catalog: Parts: Technic, Brick</a>	<a href="#">PG</a>
+	 *	1	<a href="#">3647</a>	<b>Light Gray Technic, Gear 8 Tooth Type 1</b> <a href="#">Catalog: Parts: Technic, Gear</a>	<a href="#">PG</a>
+	 *	2	<a href="#">6589</a>	<b>Light Gray Technic, Gear 12 Tooth Bevel</b> <a href="#">Catalog: Parts: Technic, Gear</a>	<a href="#">PG</a>
+	 *	1	<a href="#">6592</a>	<b>Light Gray Technic, Gear Rack 1 x 10 with Holes</b> <a href="#">Catalog: Parts: Technic, Gear</a>	<a href="#">PG</a>
+	 *	2	<a href="#">32065</a>	<b>Yellow Technic, Liftarm 1 x 7 Thin</b> <a href="#">Catalog: Parts: Technic, Liftarm</a>	<a href="#">PG</a>
+	 *	14	<a href="#">4274</a>	<b>Light Gray Technic, Pin 1/2</b> <a href="#">Catalog: Parts: Technic, Pin</a>	<a href="#">PG</a>



+	 *	4	<a href="#">32002</a>	<b>Dark Gray Technic, Pin 3/4</b> <a href="#">Catalog: Parts: Technic, Pin</a>	<a href="#">PG</a>
+	 *	6	<a href="#">6558</a>	<b>Black Technic, Pin 3L with Friction Ridges Lengthwise</b> <a href="#">Catalog: Parts: Technic, Pin</a>	<a href="#">PG</a>
+	 *	8	<a href="#">2780</a>	<b>Black Technic, Pin with Friction Ridges Lengthwise WITH Center Slots</b> <a href="#">Catalog: Parts: Technic, Pin</a>	<a href="#">PG</a>
+	 *	1	<a href="#">3709b</a>	<b>White Technic, Plate 2 x 4 with 3 Holes</b> <a href="#">Catalog: Parts: Technic, Plate</a>	<a href="#">PG</a>
+	 *	1	<a href="#">3738</a>	<b>Blue Technic, Plate 2 x 8 with 7 Holes</b> <a href="#">Catalog: Parts: Technic, Plate</a>	<a href="#">PG</a>
+	 *	1	<a href="#">3738</a>	<b>Light Gray Technic, Plate 2 x 8 with 7 Holes</b> <a href="#">Catalog: Parts: Technic, Plate</a>	<a href="#">PG</a>
+	 *	2	<a href="#">32069</a>	<b>Black Technic, Steering Arm with Pins</b> <a href="#">Catalog: Parts: Technic, Steering</a>	<a href="#">PG</a>
+	 *	2	<a href="#">3070b</a>	<b>Light Gray Tile 1 x 1 with Groove (3070)</b> <a href="#">Catalog: Parts: Tile</a>	<a href="#">PG</a>
+	 *	4	<a href="#">3069b</a>	<b>Red Tile 1 x 2 with Groove</b> <a href="#">Catalog: Parts: Tile</a>	<a href="#">PG</a>
+	 *	2	<a href="#">3069b</a>	<b>White Tile 1 x 2 with Groove</b> <a href="#">Catalog: Parts: Tile</a>	<a href="#">PG</a>
+	 *	2	<a href="#">2431</a>	<b>Light Gray Tile 1 x 4</b> <a href="#">Catalog: Parts: Tile</a>	<a href="#">PG</a>
+	 *	2	<a href="#">2431</a>	<b>Red Tile 1 x 4</b> <a href="#">Catalog: Parts: Tile</a>	<a href="#">PG</a>

+	 *	1	<a href="#">6636</a>	<b>Light Gray Tile 1 x 6</b> <a href="#">Catalog:</a> <a href="#">Parts:</a> <a href="#">Tile</a>	<a href="#">PG</a>
+	 *	4	<a href="#">6636</a>	<b>White Tile 1 x 6</b> <a href="#">Catalog:</a> <a href="#">Parts:</a> <a href="#">Tile</a>	<a href="#">PG</a>
+	 *	4	<a href="#">3068b</a>	<b>Light Gray Tile 2 x 2 with Groove</b> <a href="#">Catalog:</a> <a href="#">Parts:</a> <a href="#">Tile</a>	<a href="#">PG</a>
+	 *	4	<a href="#">3068b</a>	<b>Red Tile 2 x 2 with Groove</b> <a href="#">Catalog:</a> <a href="#">Parts:</a> <a href="#">Tile</a>	<a href="#">PG</a>
+	 *	4	<a href="#">2555</a>	<b>White Tile, Modified 1 x 1 with Clip</b> <a href="#">Catalog:</a> <a href="#">Parts:</a> <a href="#">Tile, Modified</a>	<a href="#">PG</a>
+	 *	21	<a href="#">2412b</a>	<b>Light Gray Tile, Modified 1 x 2 Grille with Bottom Groove / Lip</b> <a href="#">Catalog:</a> <a href="#">Parts:</a> <a href="#">Tile, Modified</a>	<a href="#">PG</a>
+	 *	2	<a href="#">2432</a>	<b>Light Gray Tile, Modified 1 x 2 with Handle</b> <a href="#">Catalog:</a> <a href="#">Parts:</a> <a href="#">Tile, Modified</a>	<a href="#">PG</a>
+	 *	4	<a href="#">6179</a>	<b>White Tile, Modified 4 x 4 with Studs on Edge</b> <a href="#">Catalog:</a> <a href="#">Parts:</a> <a href="#">Tile, Modified</a>	<a href="#">PG</a>
+	 *	2	<a href="#">6180</a>	<b>Red Tile, Modified 4 x 6 with Studs on Edges</b> <a href="#">Catalog:</a> <a href="#">Parts:</a> <a href="#">Tile, Modified</a>	<a href="#">PG</a>
+	 *	2	<a href="#">6180</a>	<b>White Tile, Modified 4 x 6 with Studs on Edges</b> <a href="#">Catalog:</a> <a href="#">Parts:</a> <a href="#">Tile, Modified</a>	<a href="#">PG</a>
+	 *	1	<a href="#">4150</a>	<b>Light Gray Tile, Round 2 x 2</b> <a href="#">Catalog:</a> <a href="#">Parts:</a> <a href="#">Tile, Round</a>	<a href="#">PG</a>
+	 *	4	<a href="#">32003</a>	<b>Black Tire 68.8 x 24</b> <a href="#">Catalog:</a> <a href="#">Parts:</a> <a href="#">Tire &amp; Tread</a>	<a href="#">PG</a>

+		1	<a href="#">71972</a>	<b>Chrome Silver Vehicle, Grille Guard</b> <a href="#">Catalog: Parts: Vehicle</a>	<a href="#">PG</a>
---	--	---	-----------------------	---	--------------------

+		4	<a href="#">32004b</a>	<b>Light Gray Wheel 68.8 x 24 Model Team Type 2 (notches around wheel ring)</b> <a href="#">Catalog: Parts: Wheel</a>	<a href="#">PG</a>
---	---	---	------------------------	--	--------------------

+		1	<a href="#">6267</a>	<b>Trans-Clear Windscreen 2 x 12 x 4</b> <a href="#">Catalog: Parts: Windscreen</a>	<a href="#">PG</a>
---	---	---	----------------------	--	--------------------

**Extra Items:**

+		1	<a href="#">4592c03(inv)</a>	<b>Light Gray Lever Small Base with Light Gray Lever</b> <a href="#">Catalog: Parts: Lever</a>	<a href="#">PG</a>
---	---	---	------------------------------	---	--------------------

+		1	<a href="#">4073</a>	<b>Black Plate, Round 1 x 1</b> <a href="#">Catalog: Parts: Plate, Round</a>	<a href="#">PG</a>
---	---	---	----------------------	---	--------------------

+		1	<a href="#">4073</a>	<b>Light Gray Plate, Round 1 x 1</b> <a href="#">Catalog: Parts: Plate, Round</a>	<a href="#">PG</a>
---	--	---	----------------------	--	--------------------

+		1	<a href="#">4073</a>	<b>Trans-Red Plate, Round 1 x 1</b> <a href="#">Catalog: Parts: Plate, Round</a>	<a href="#">PG</a>
---	---	---	----------------------	---	--------------------

+		1	<a href="#">4073</a>	<b>Trans-Yellow Plate, Round 1 x 1</b> <a href="#">Catalog: Parts: Plate, Round</a>	<a href="#">PG</a>
---	---	---	----------------------	--	--------------------

+		1	<a href="#">4073</a>	<b>White Plate, Round 1 x 1</b> <a href="#">Catalog: Parts: Plate, Round</a>	<a href="#">PG</a>
---	---	---	----------------------	---	--------------------

+		1	<a href="#">3713</a>	<b>Light Gray Technic Bush</b> <a href="#">Catalog: Parts: Technic</a>	<a href="#">PG</a>
---	---	---	----------------------	---	--------------------

+		1	<a href="#">4265c</a>	<b>Light Gray Technic Bush 1/2 Smooth</b> <a href="#">Catalog: Parts: Technic</a>	<a href="#">PG</a>
---	---	---	-----------------------	--	--------------------

+		1	<a href="#">4274</a>	<b>Light Gray Technic, Pin 1/2</b> <a href="#">Catalog: Parts: Technic, Pin</a>	<a href="#">PG</a>
---	---	---	----------------------	--	--------------------



\*

+



\*

1

[32002](#)**Dark Gray Technic, Pin 3/4**[Catalog: Parts: Technic, Pin](#)[PG](#)

+

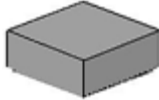

\*

1

[3070b](#)**Light Gray Tile 1 x 1 with Groove (3070)**[Catalog: Parts: Tile](#)[PG](#)**Counterparts:**

+



\*

1

[30073pb01](#)**White Door 1 x 6 x 8 Left with Octan Logo and 'DIESEL POWER' Pattern (Sticker) - Set 5563**[Catalog: Parts: Door, Decorated](#)[PG](#)

+



\*

1

[30074pb01](#)**White Door 1 x 6 x 8 Right with Octan Logo and 'DIESEL POWER' Pattern (Sticker) - Set 5563**[Catalog: Parts: Door, Decorated](#)[PG](#)

+



\*

2

[3937c03\(inv\)](#)**Light Gray Hinge Brick 1 x 2 Base with Blue Hinge Brick 1 x 2 Top (3937 / 3938)**[Catalog: Parts: Hinge](#)[PG](#)

+



\*

1

[3937c09\(inv\)](#)**Black Hinge Brick 1 x 2 Base with Light Gray Hinge Brick 1 x 2 Top (3937 / 3938)**[Catalog: Parts: Hinge](#)[PG](#)

+



\*

1

[3068bpb0350](#)**Light Gray Tile 2 x 2 with Groove with 'MT 5563' Pattern (Sticker) - Set 5563**[Catalog: Parts: Tile, Decorated](#)[PG](#)

+



\*

1

[6179pb145L](#)**White Tile, Modified 4 x 4 with Studs on Edge with Octan Logo and 'DIESEL POWER' Pattern Model Left Side (Sticker) - Set 5563**[Catalog: Parts: Tile, Modified, Decorated](#)[PG](#)

+



\*

4

[32004bc01\(inv\)](#)**Light Gray Wheel 68.8 x 24 Model Team Type 2 (notches around wheel ring) with Black Tire 68.8 x 24 ( 32004b / 32003)**[Catalog: Parts: Wheel & Tire Assembly](#)[PG](#)**Summary:**

Type	Unique Lots	Total Qty
<b>Regular Items:</b>		
Parts	206	789
<b>Extra Items:</b>		

Parts	11	11
<b>Counterparts:</b>		
Parts	7	11

[peloquin \(460\)](#)  inventoried this Set on Jun 14, 2004, inventory last updated on Oct 1, 2018.