

**LEGO**

**MODEL TEAM 5550**

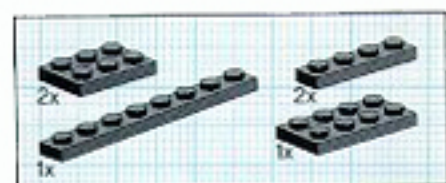

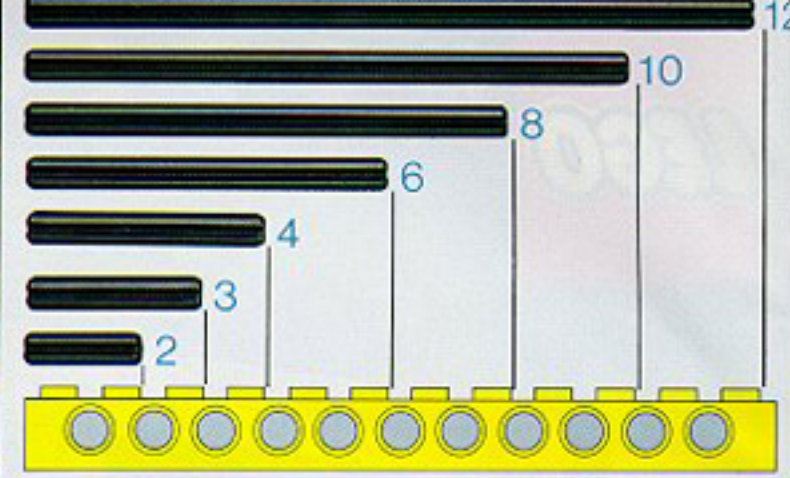



**1**

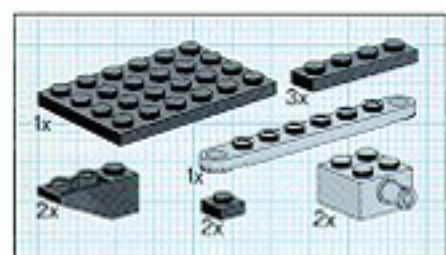
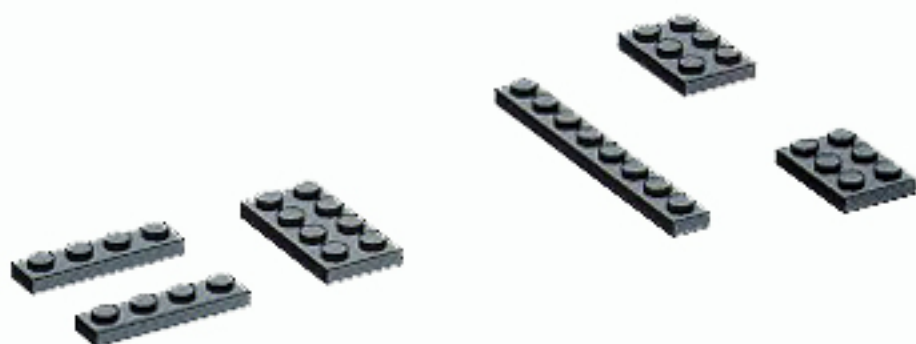

**2**

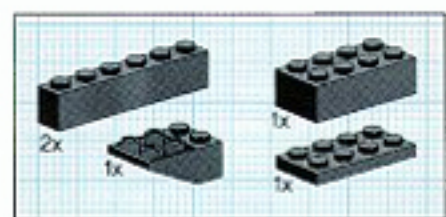
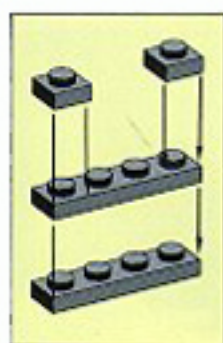

**3**

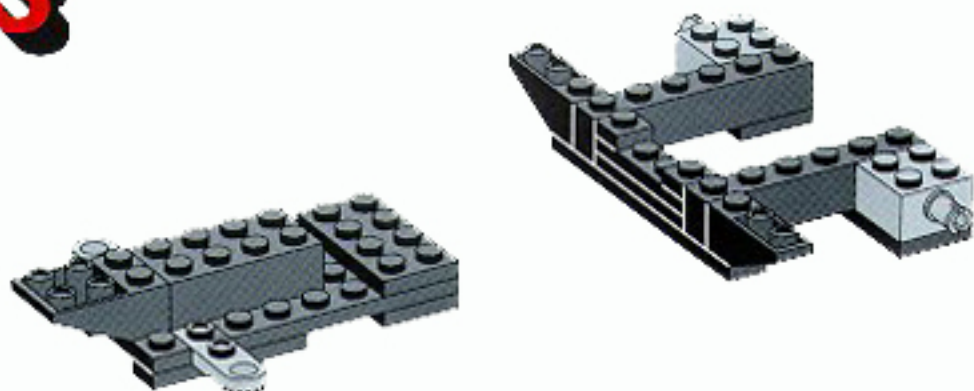











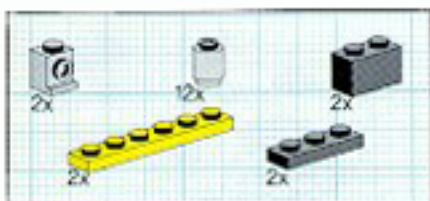

**8**

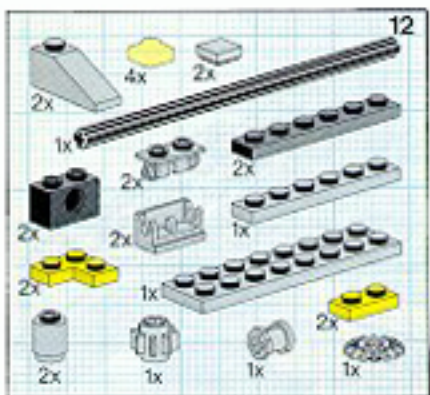
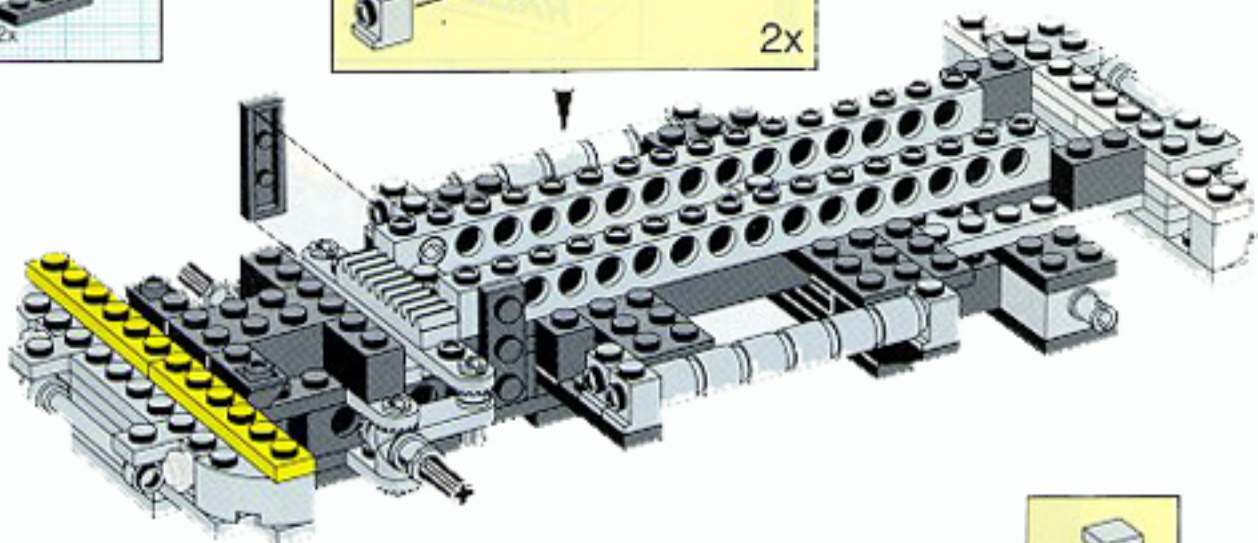

**9**

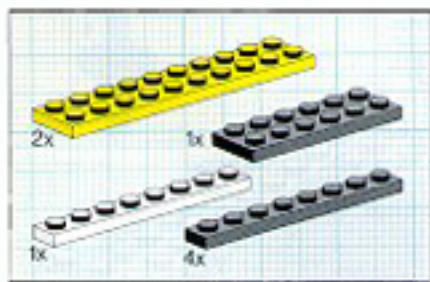
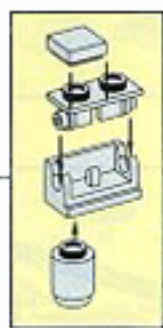
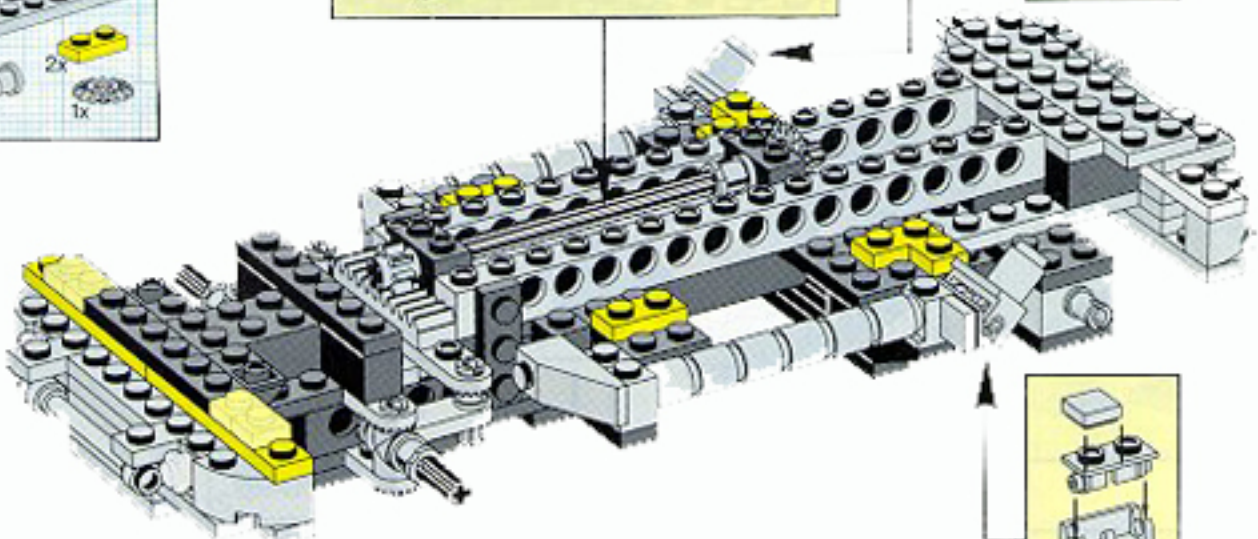
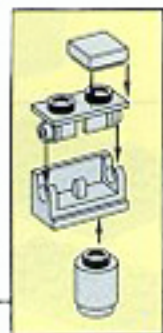
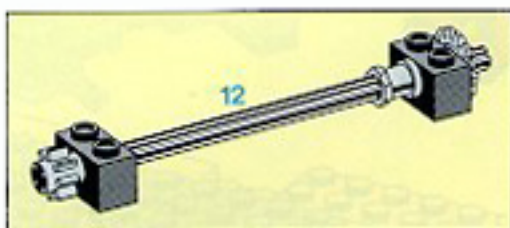

**10**

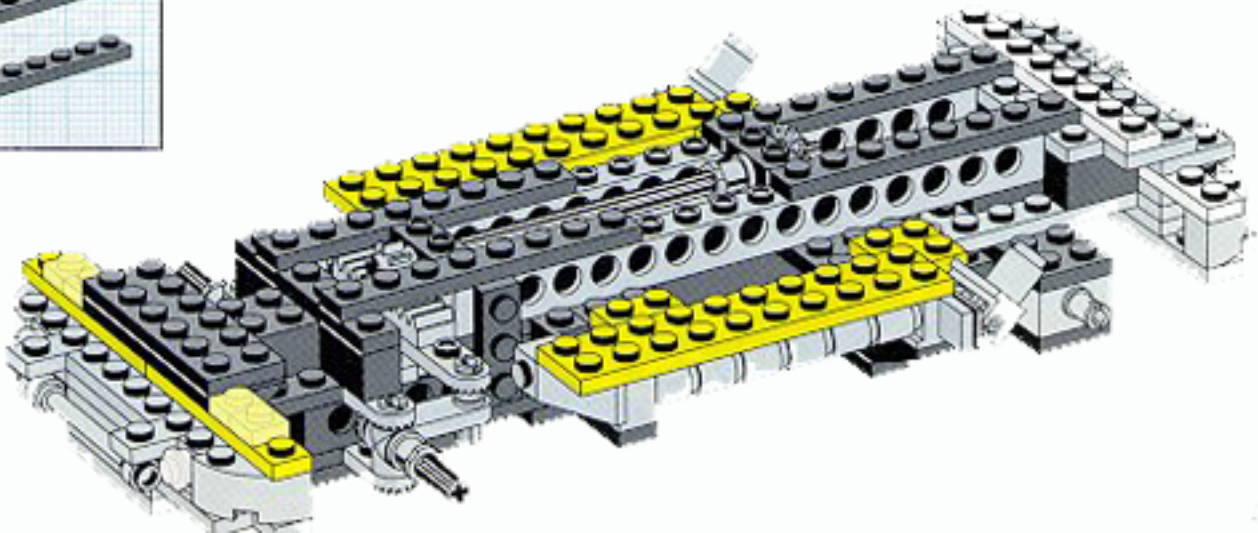



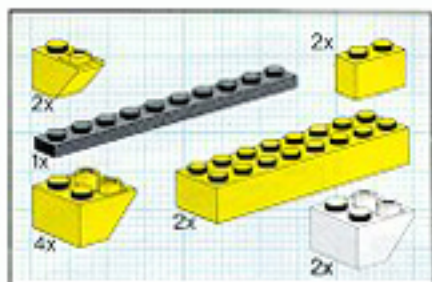

**11**

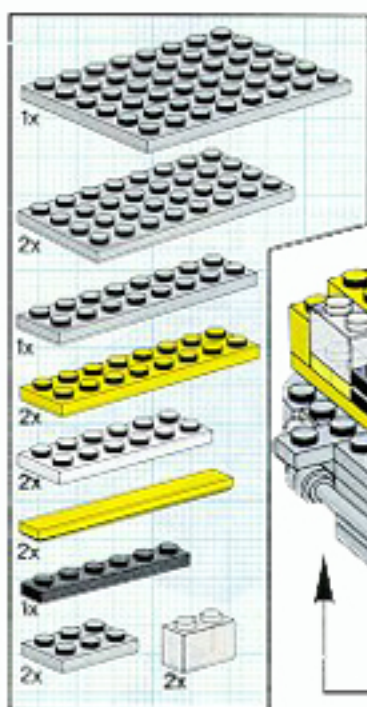
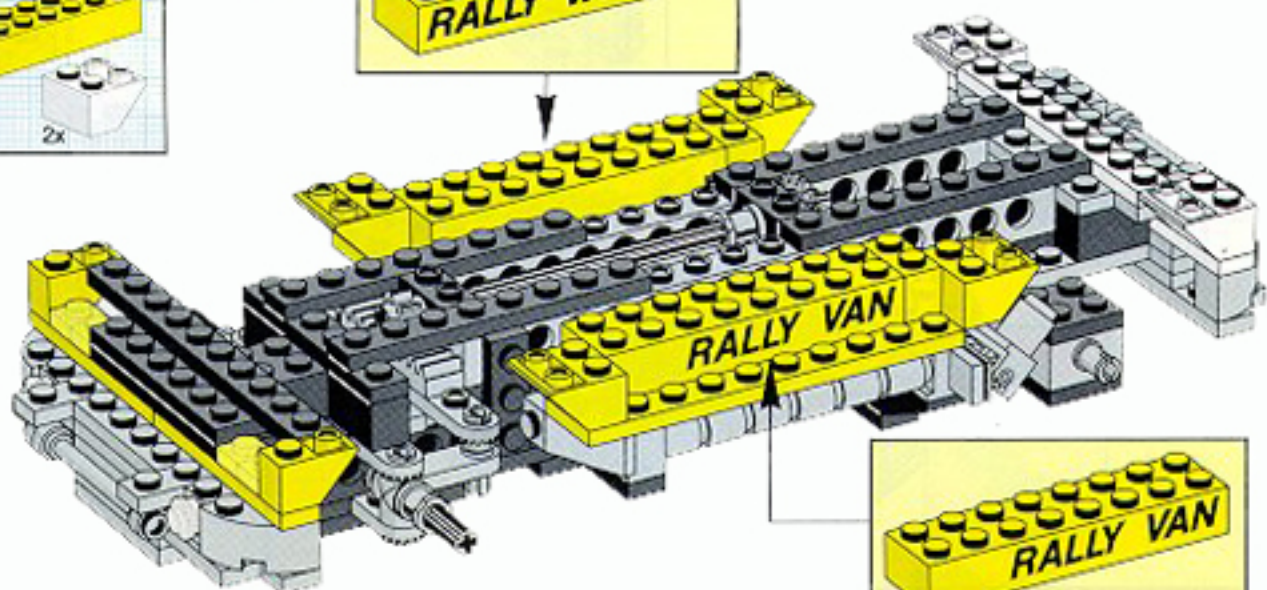

**12**

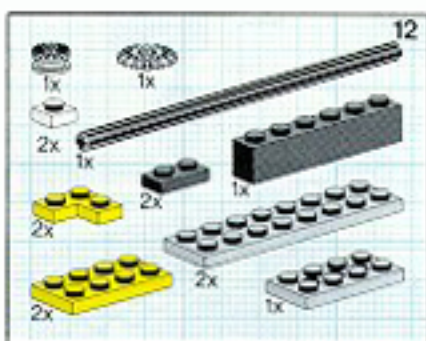
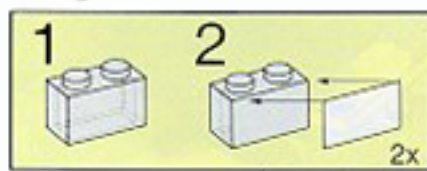
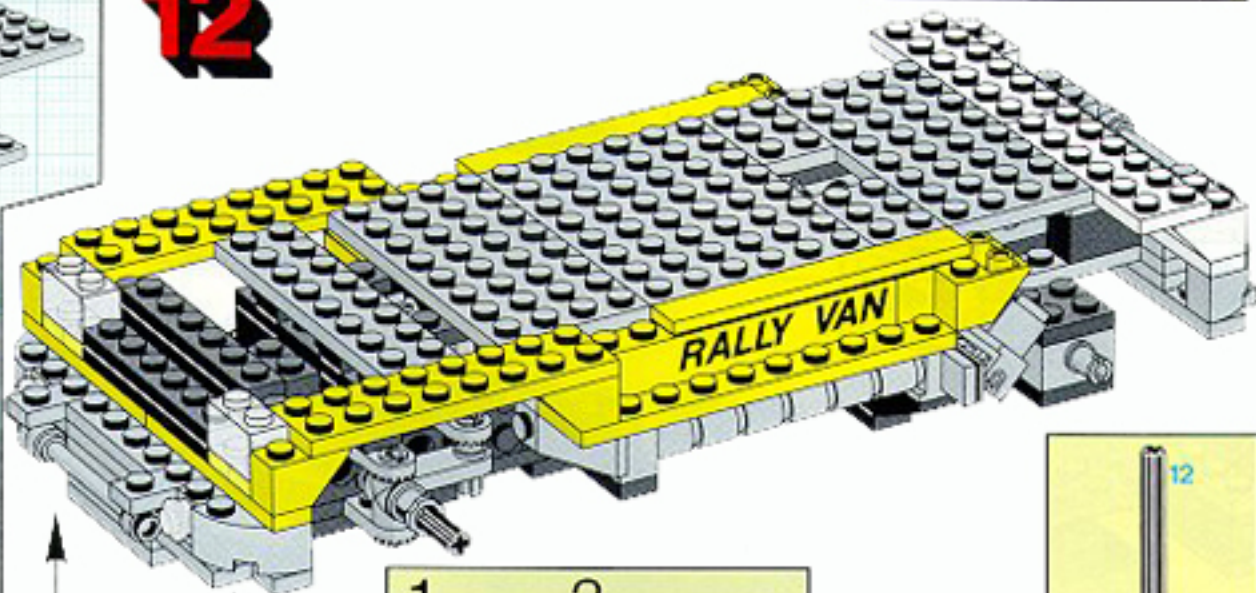

**13**

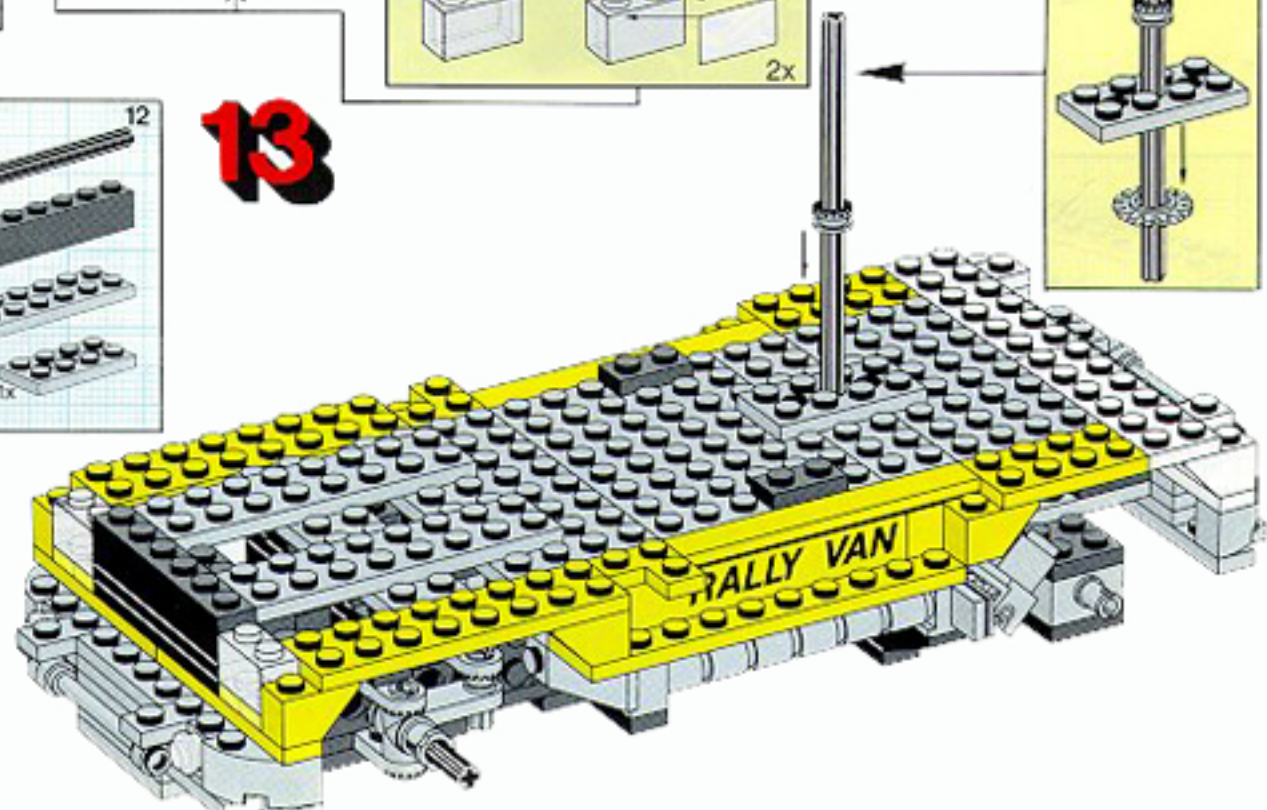



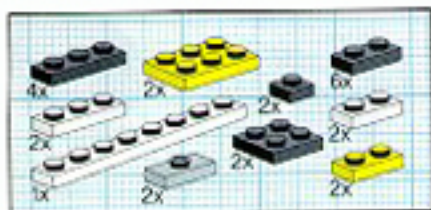

**14**

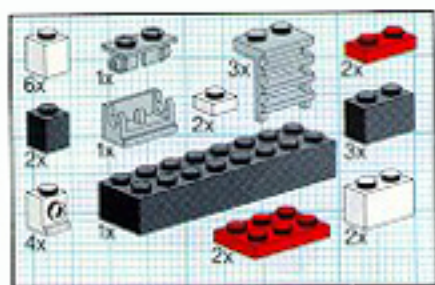
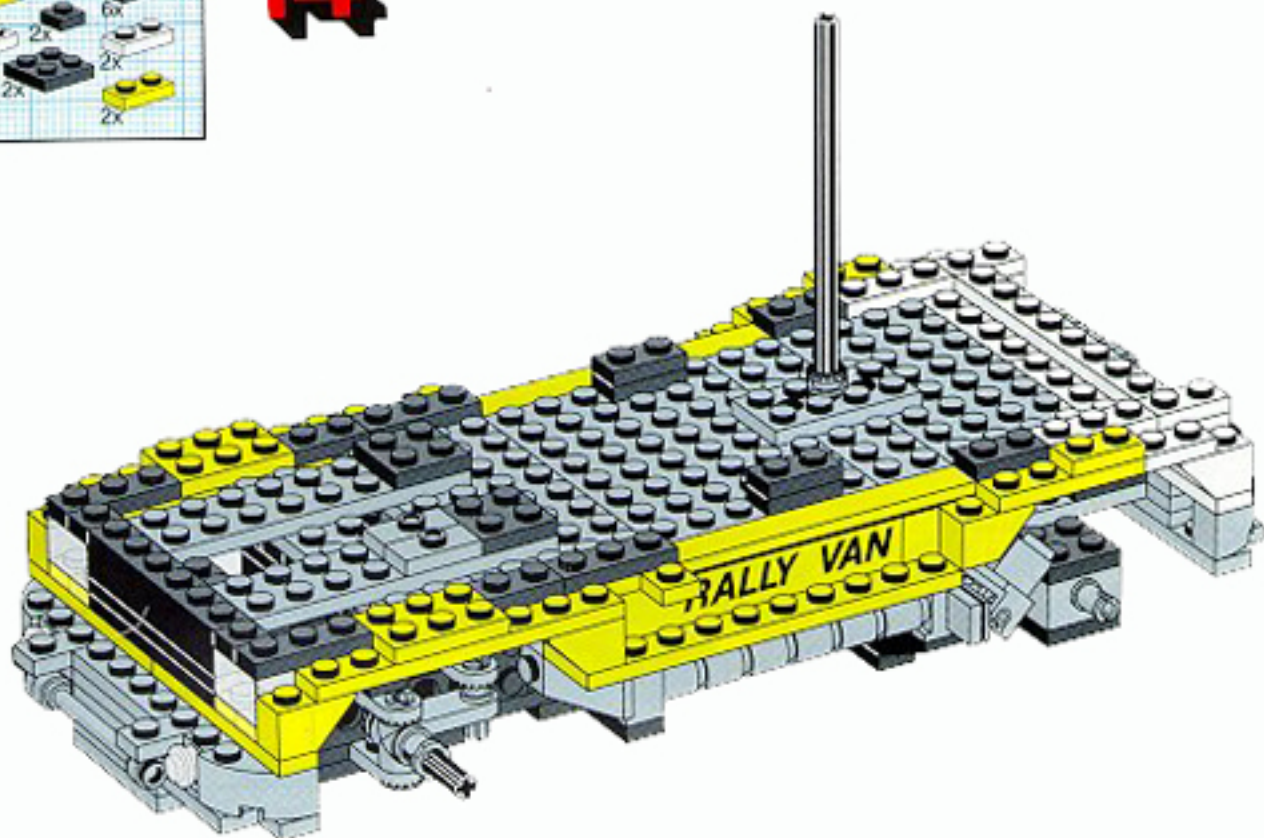

**15**

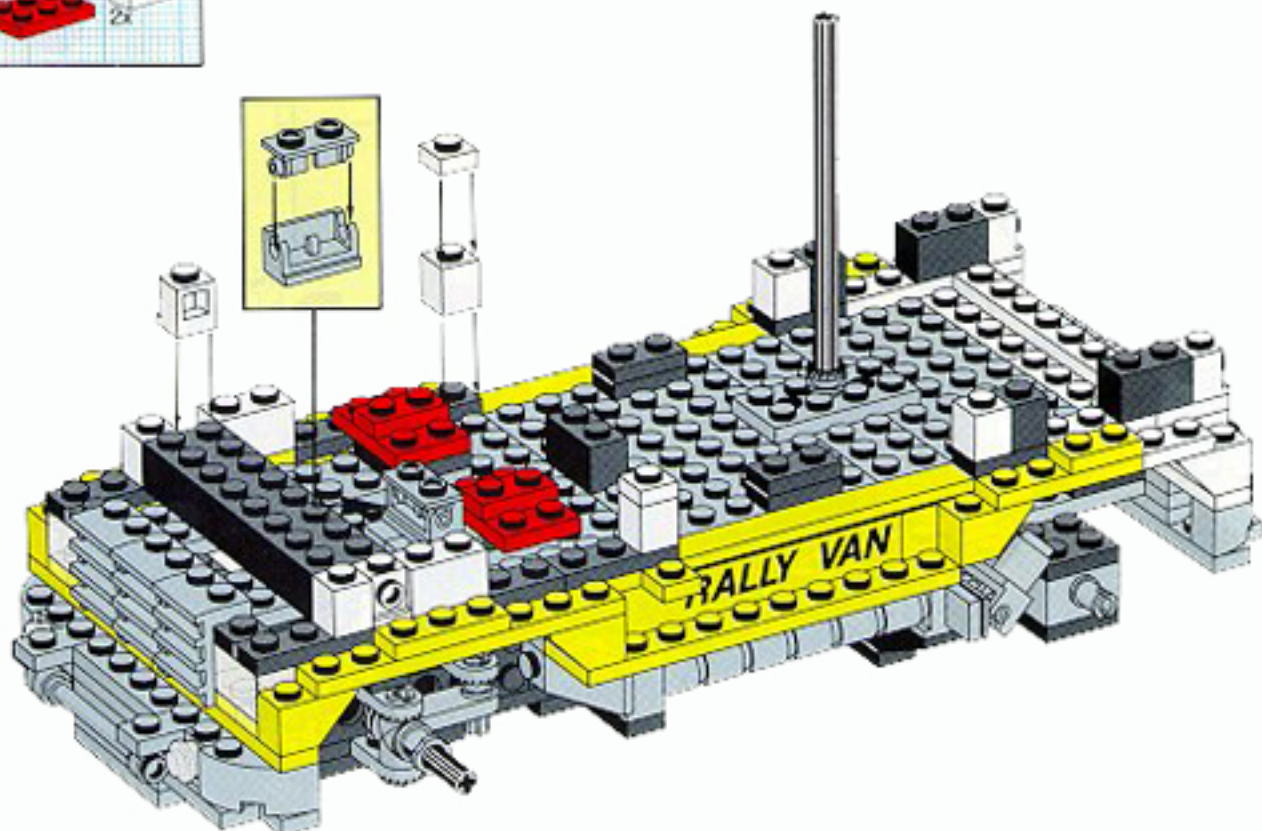



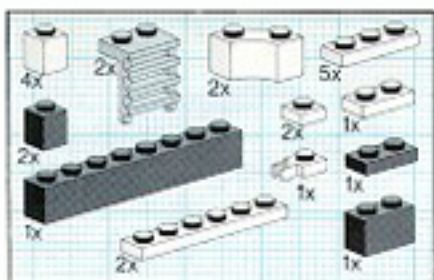

# 16

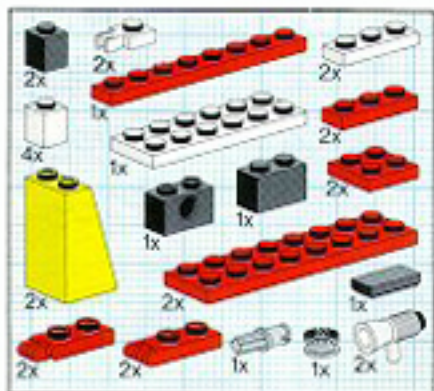
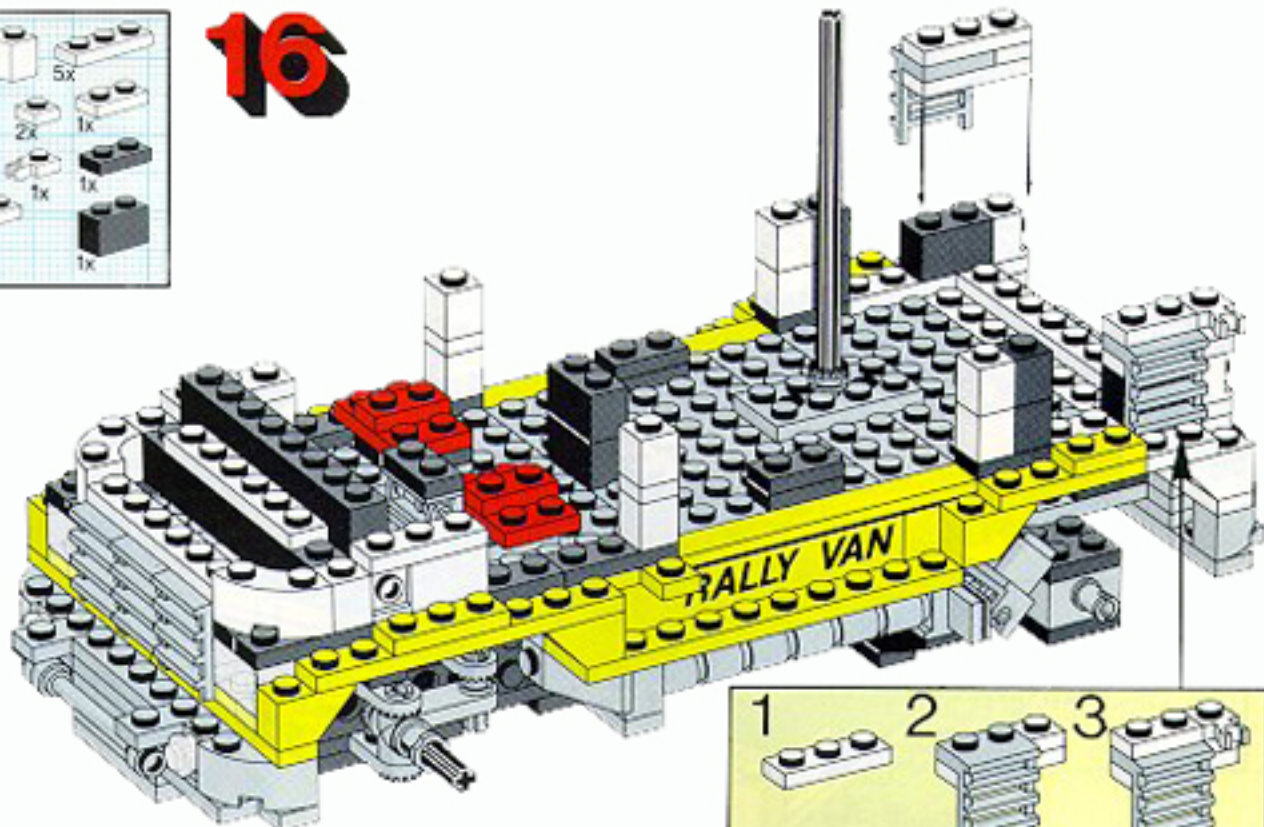

# 17

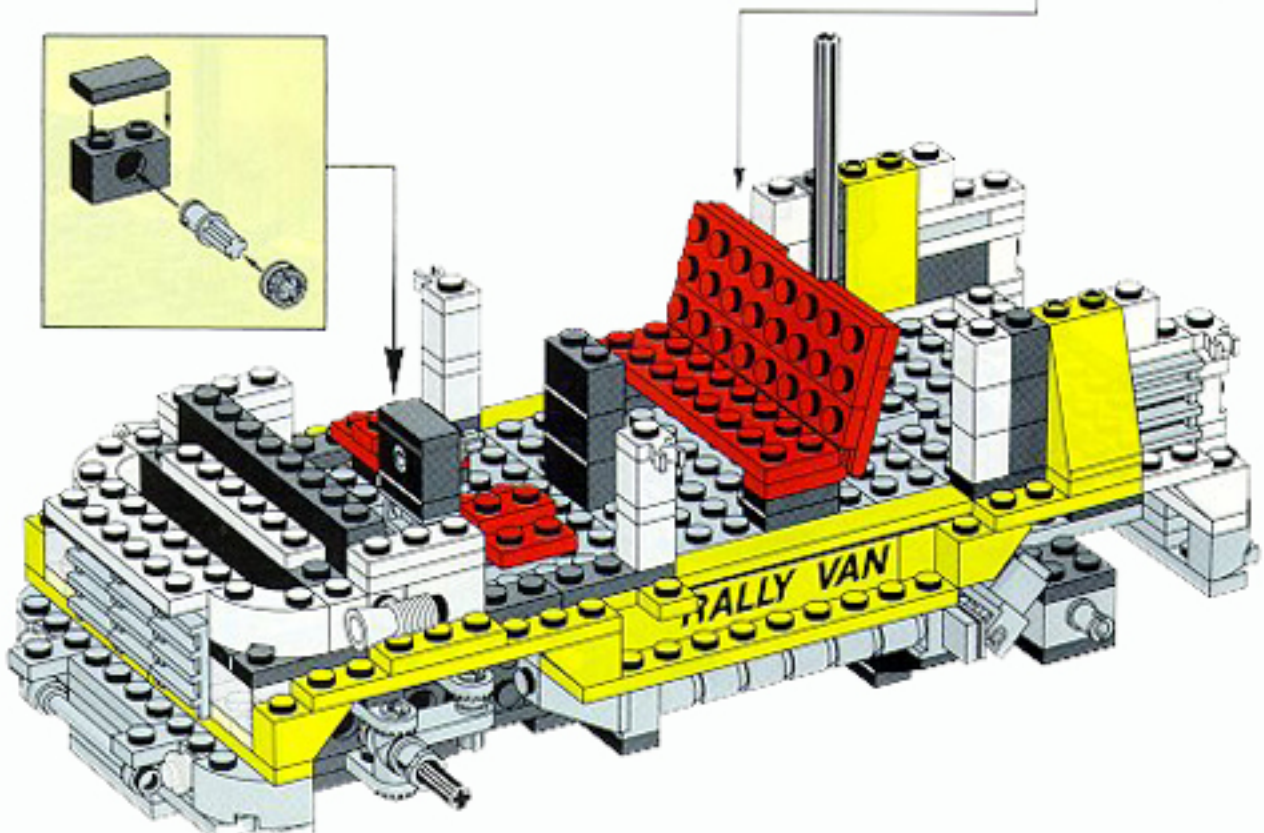
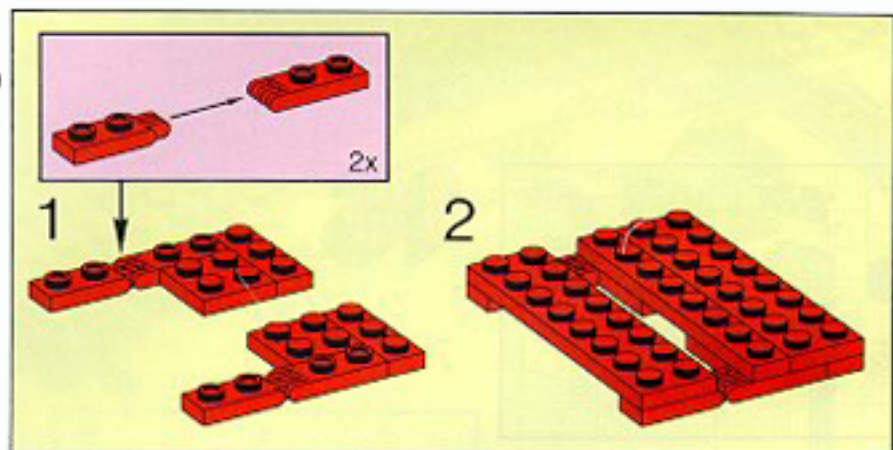



# 18

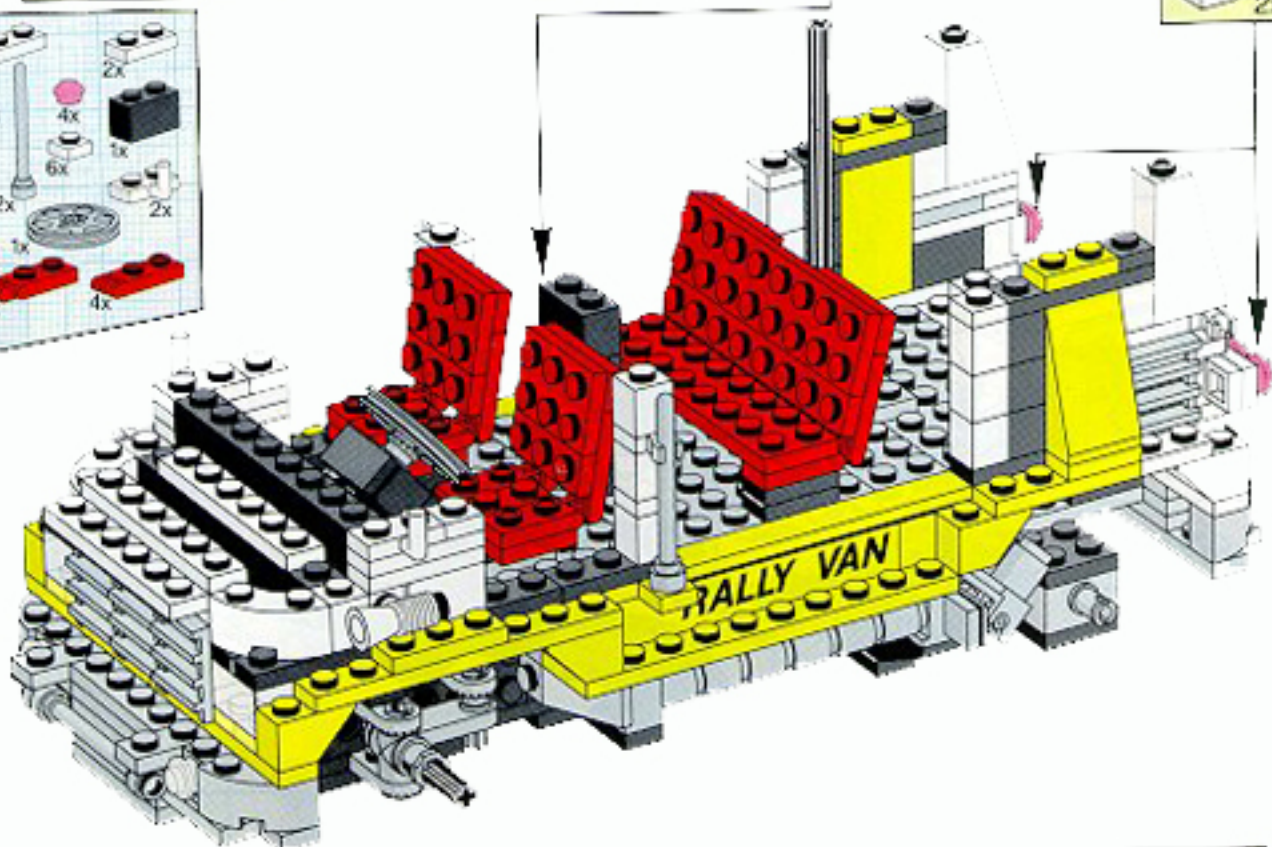
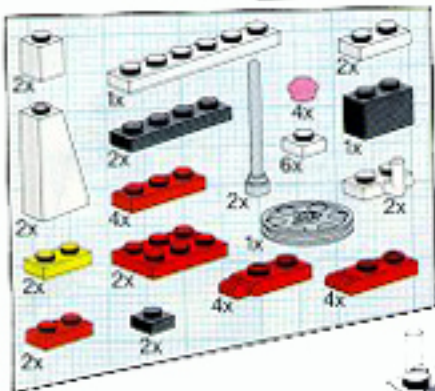
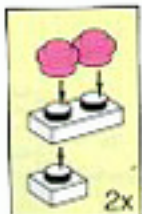

# 19

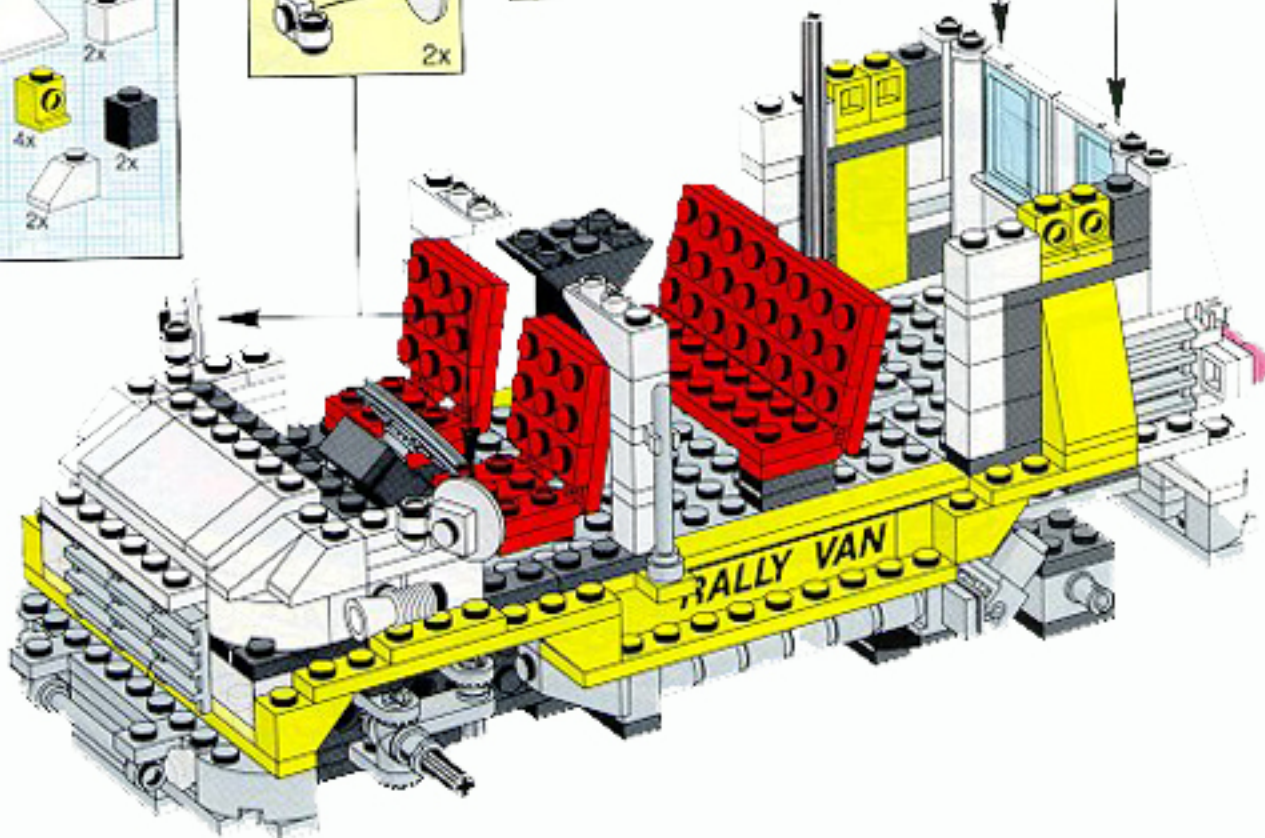
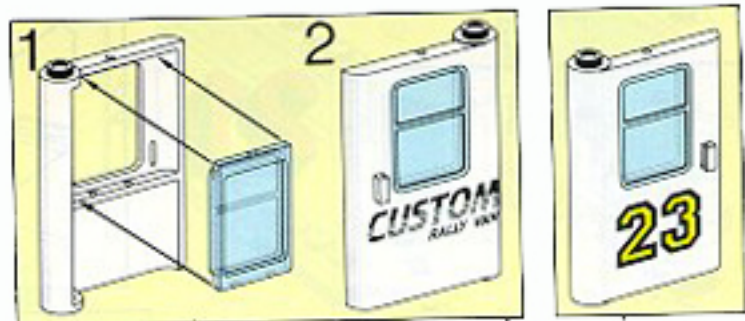
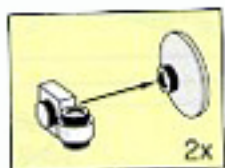



# 20

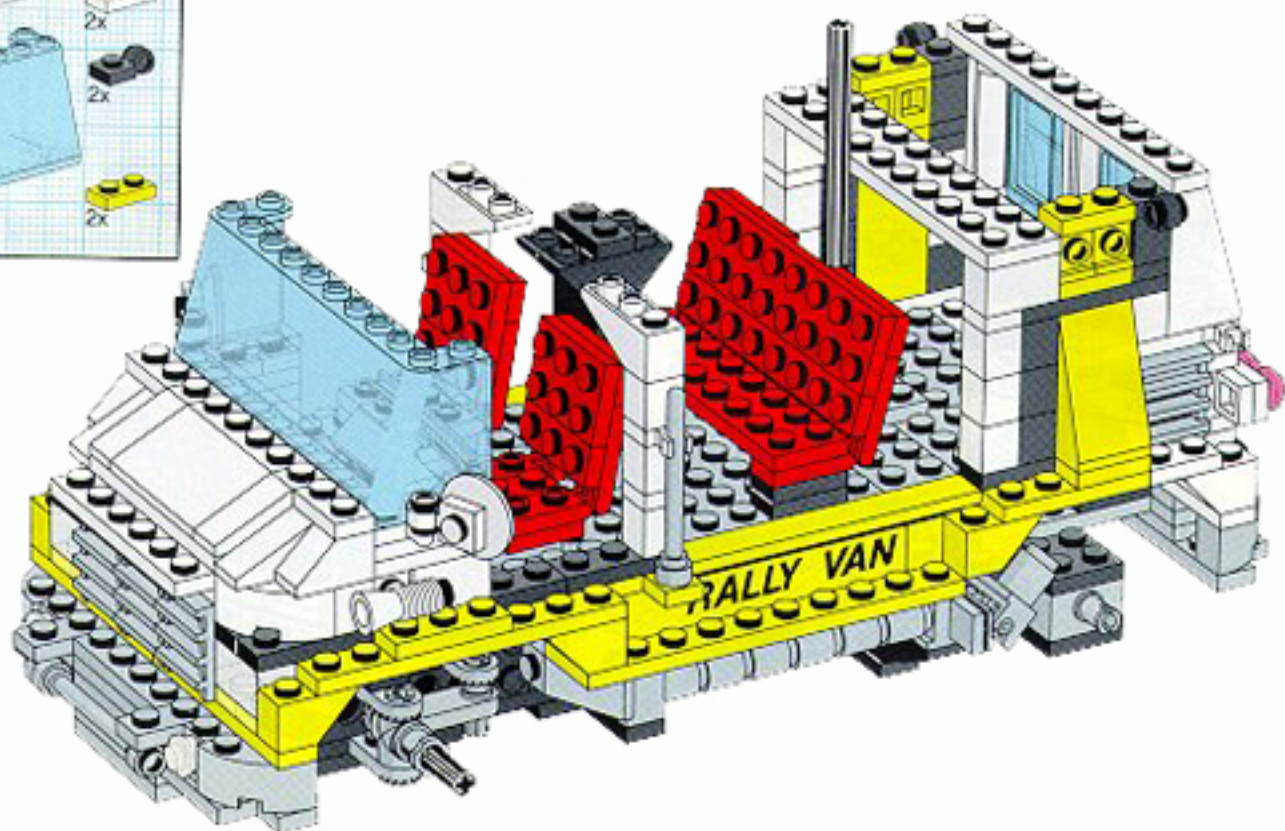
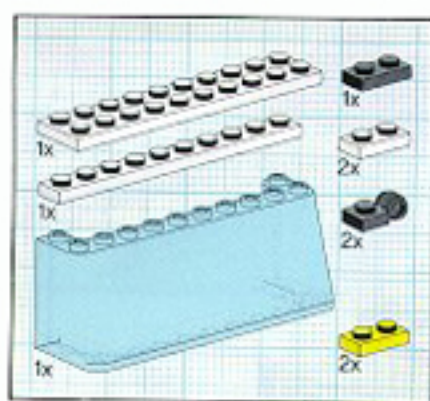

# 21

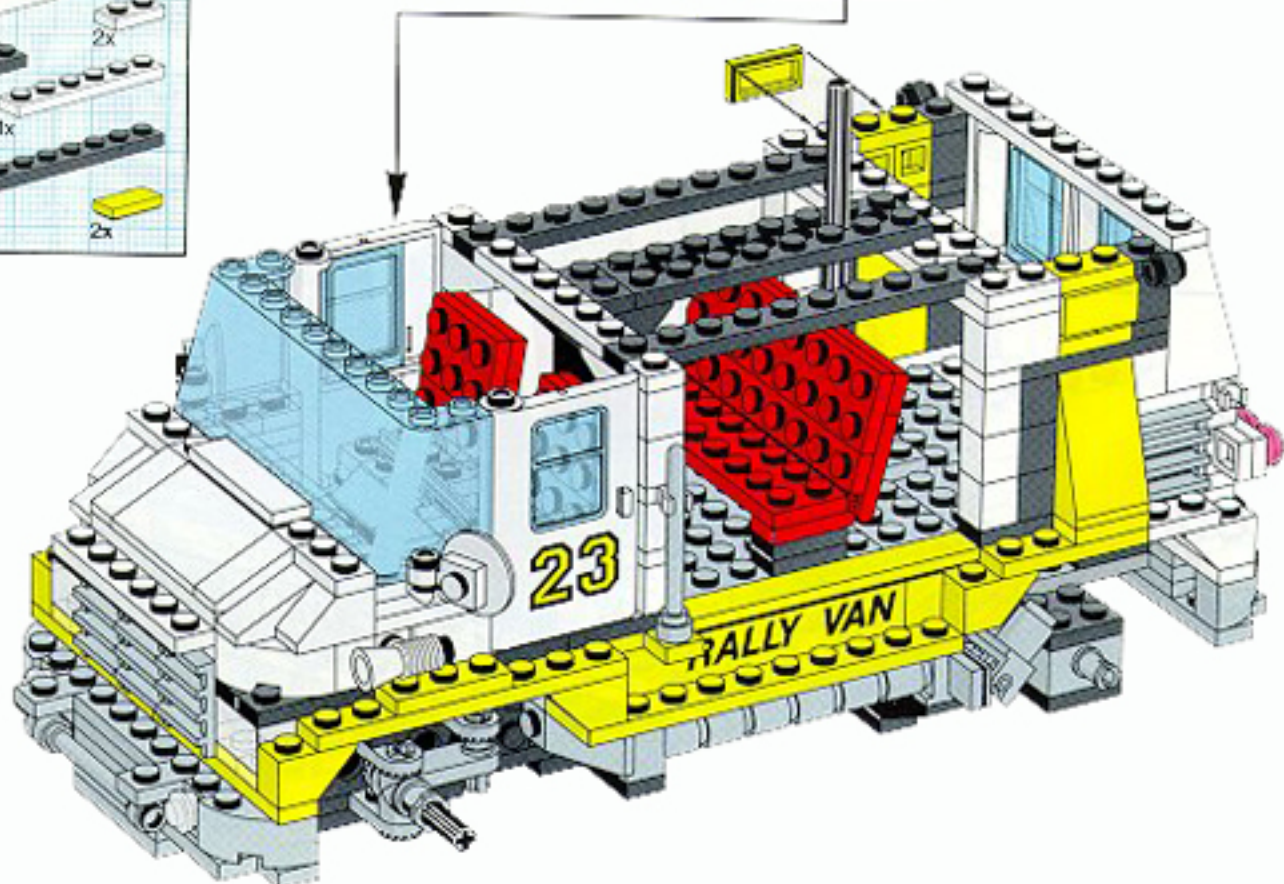
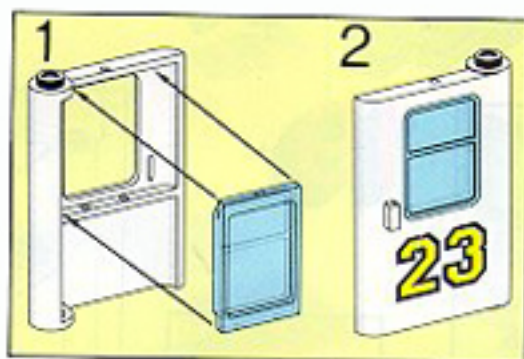
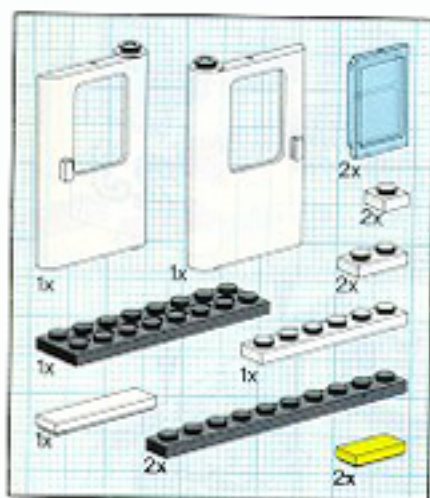



# 22

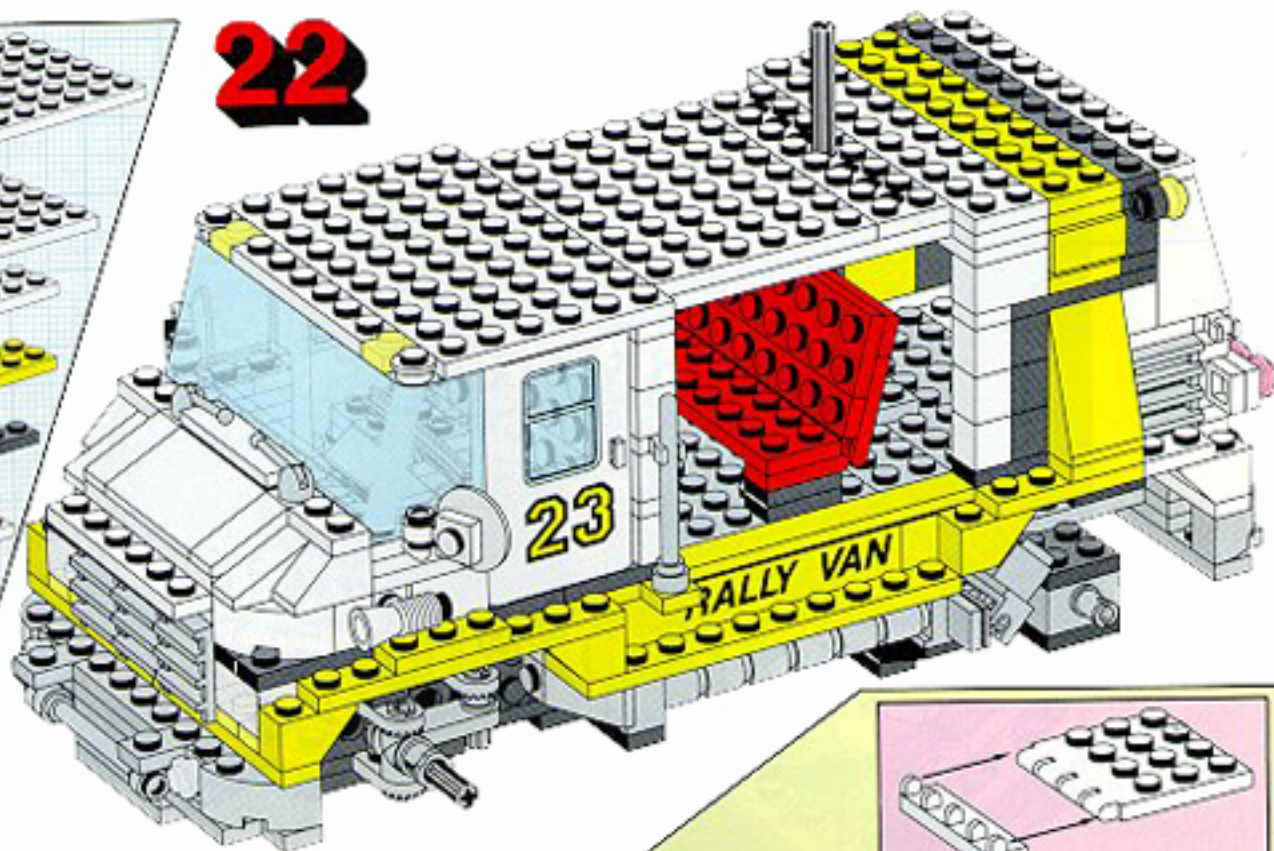
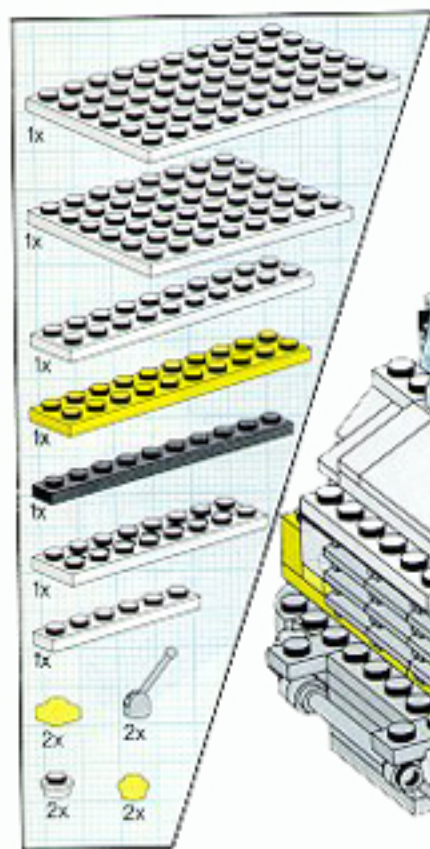

# 23

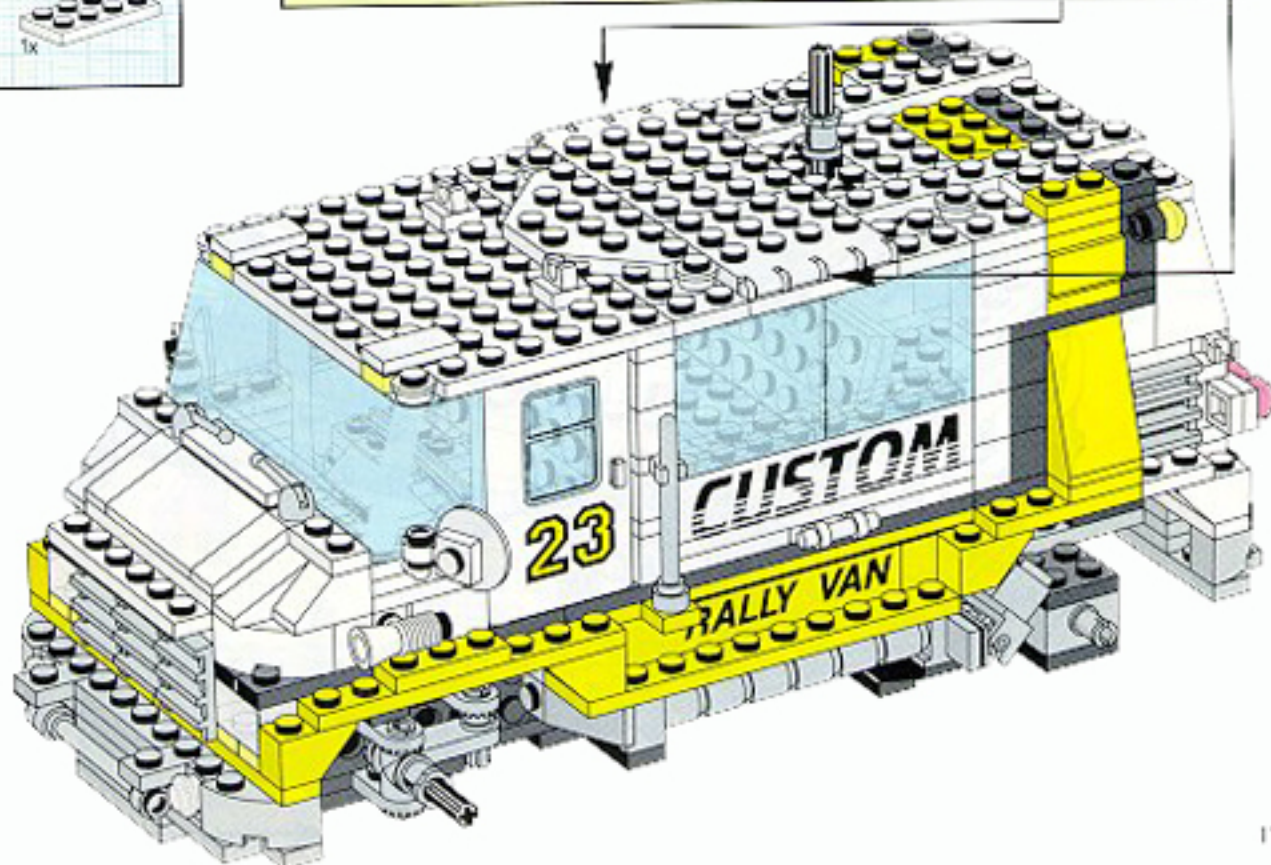
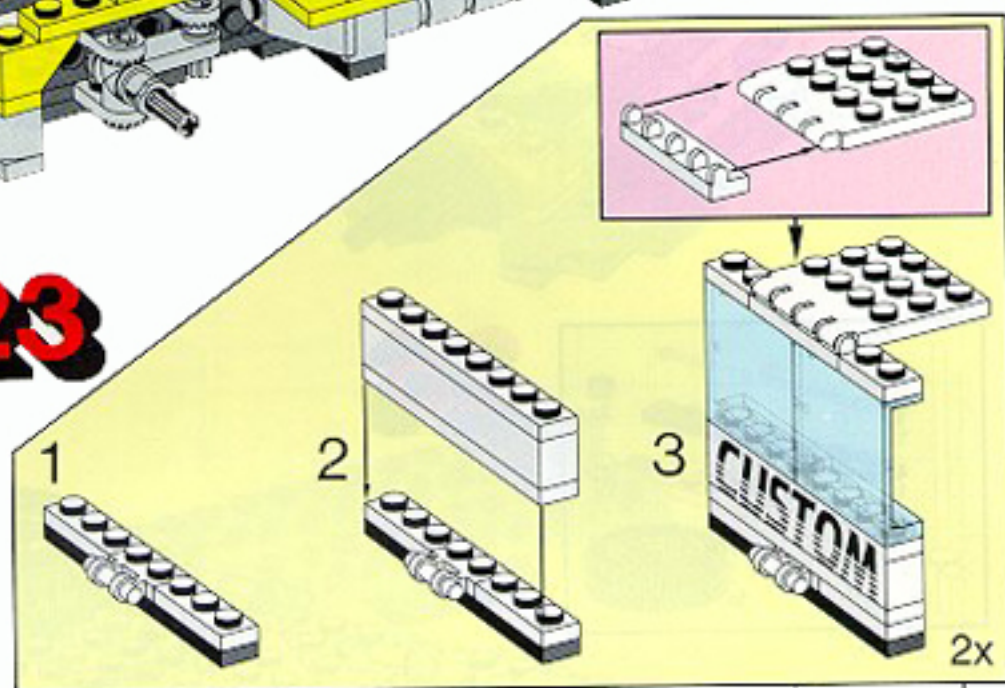
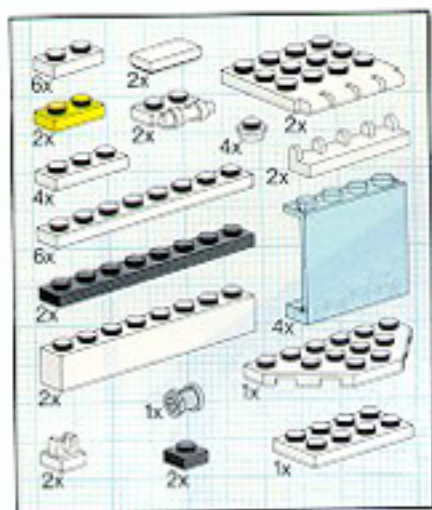



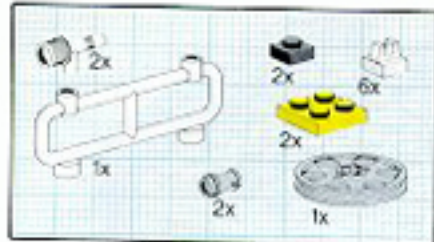

**24**

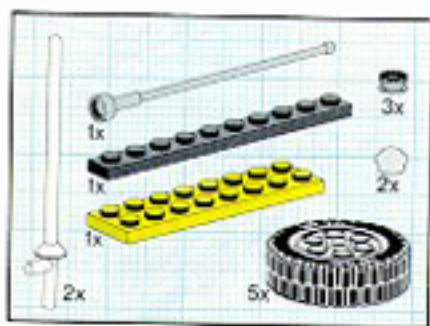
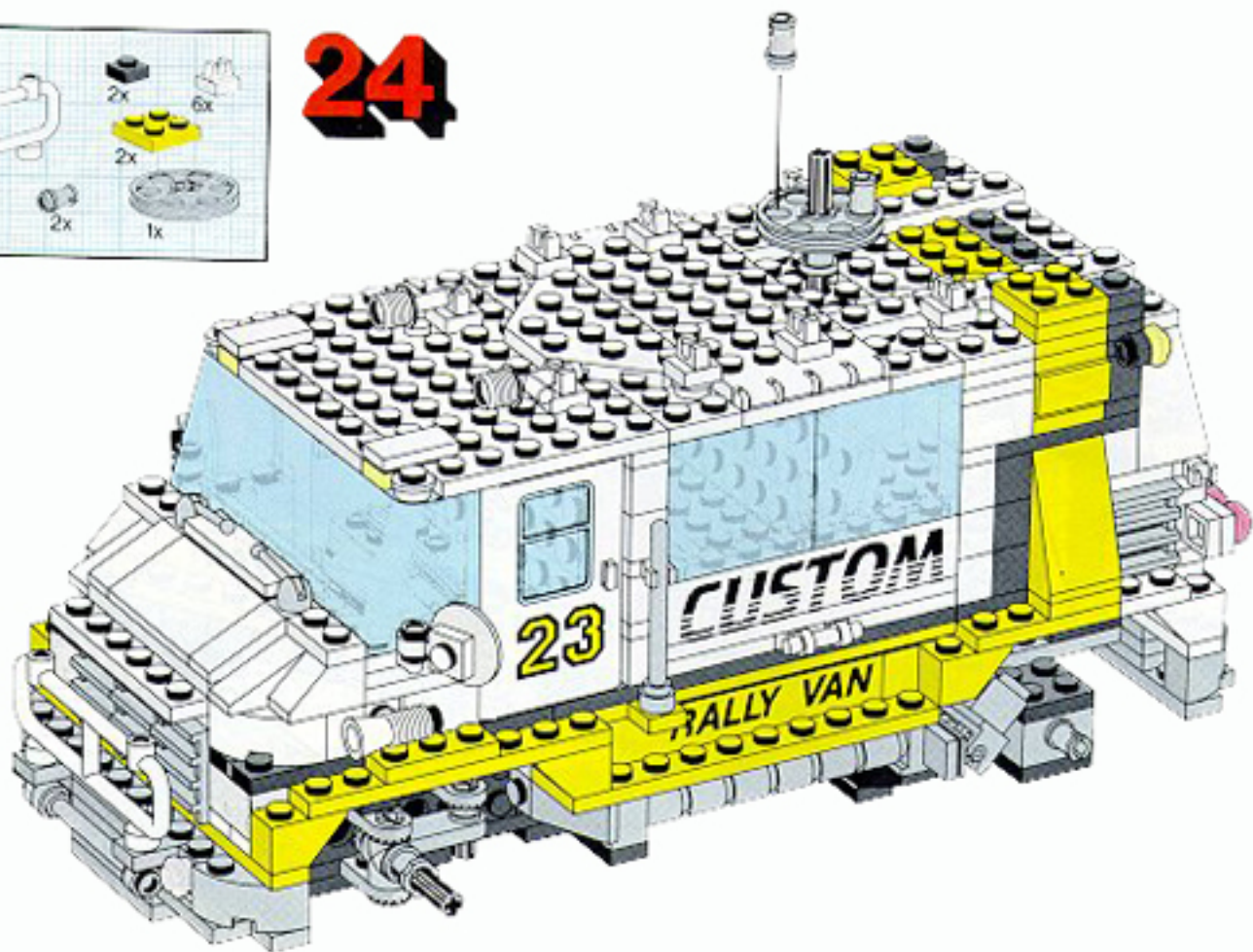

**25**

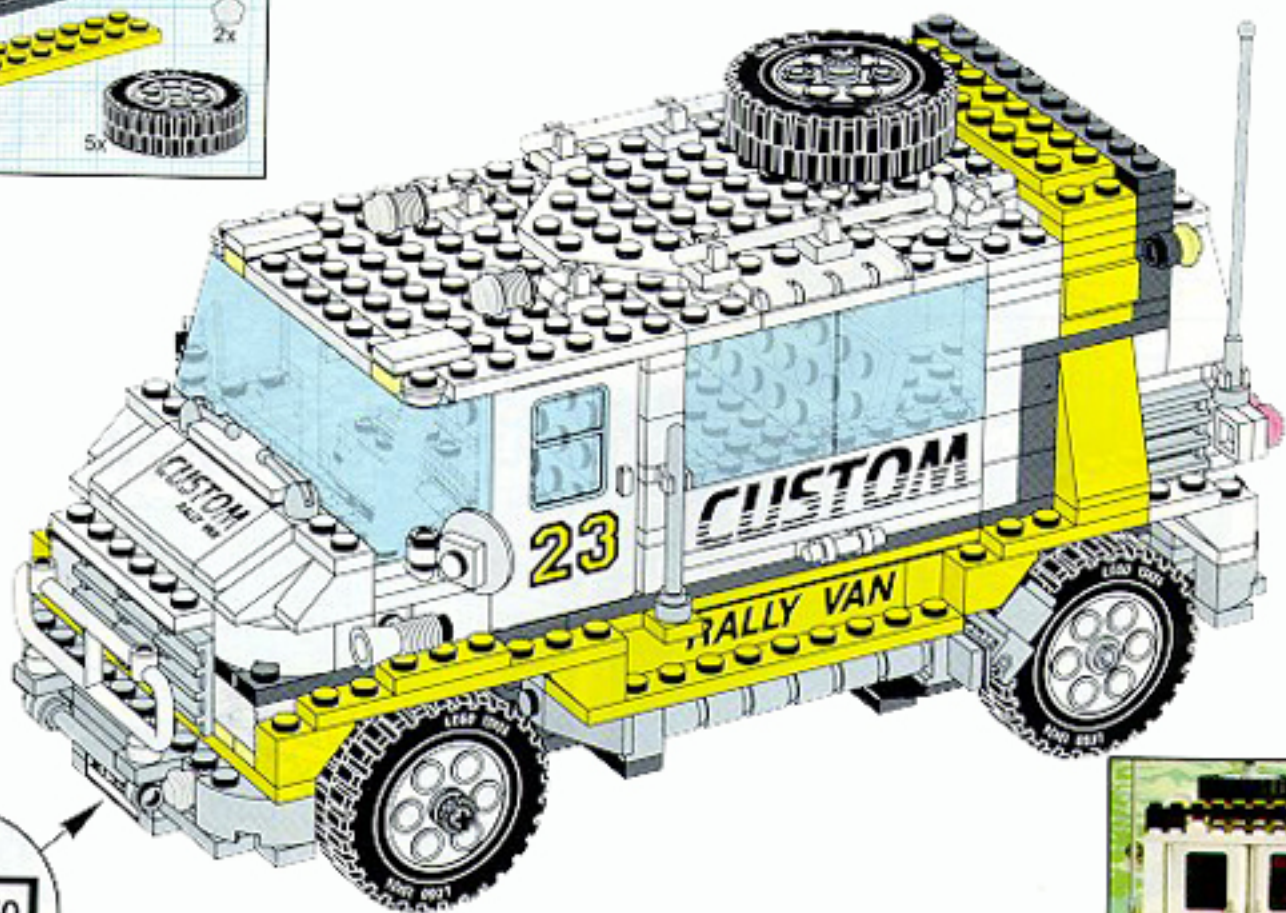



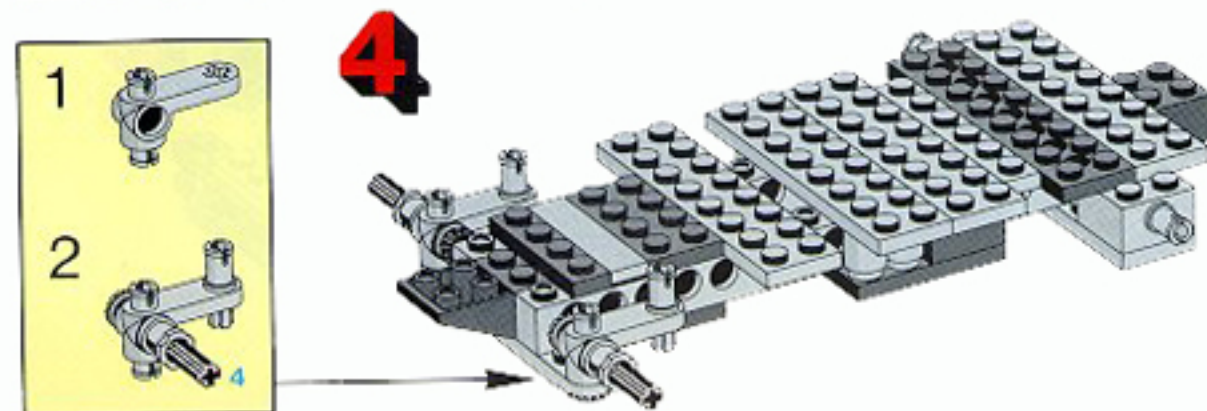
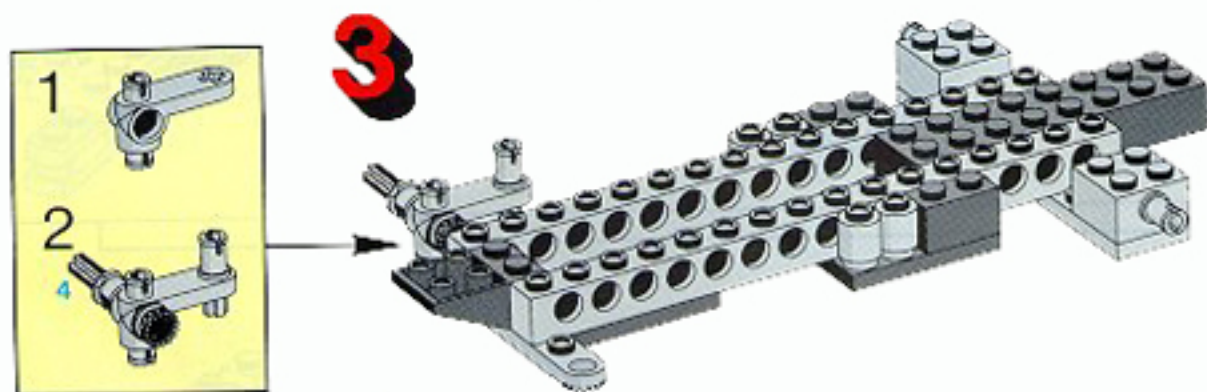







7

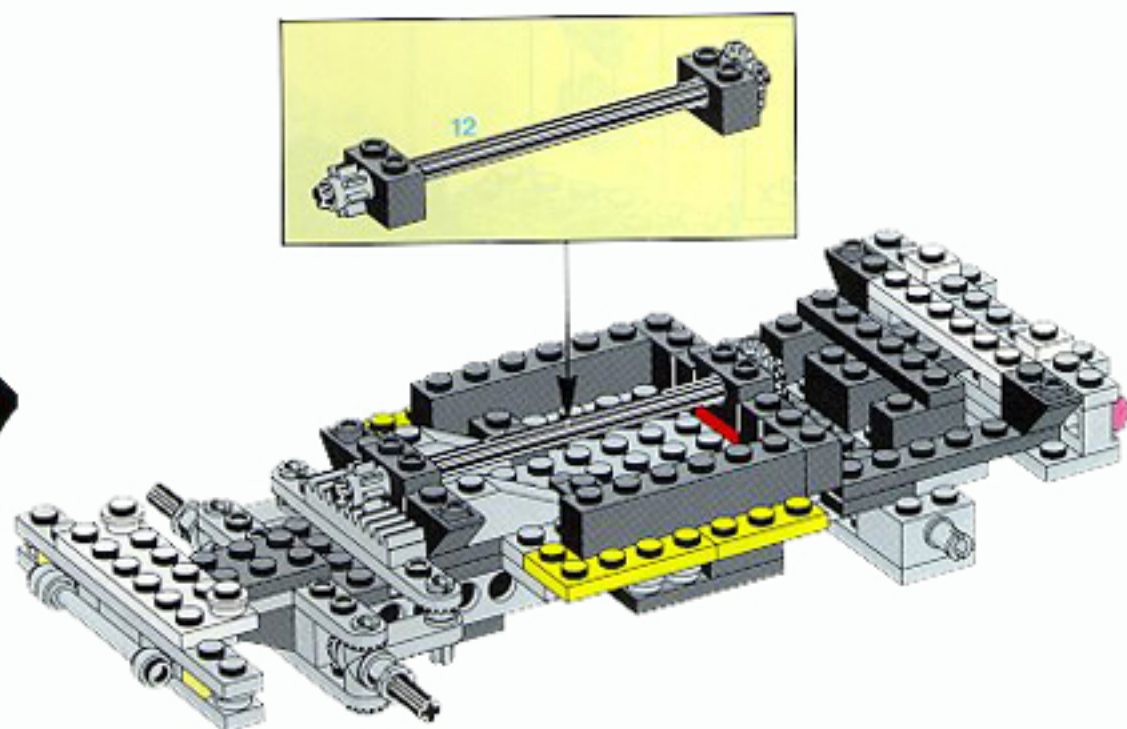

8

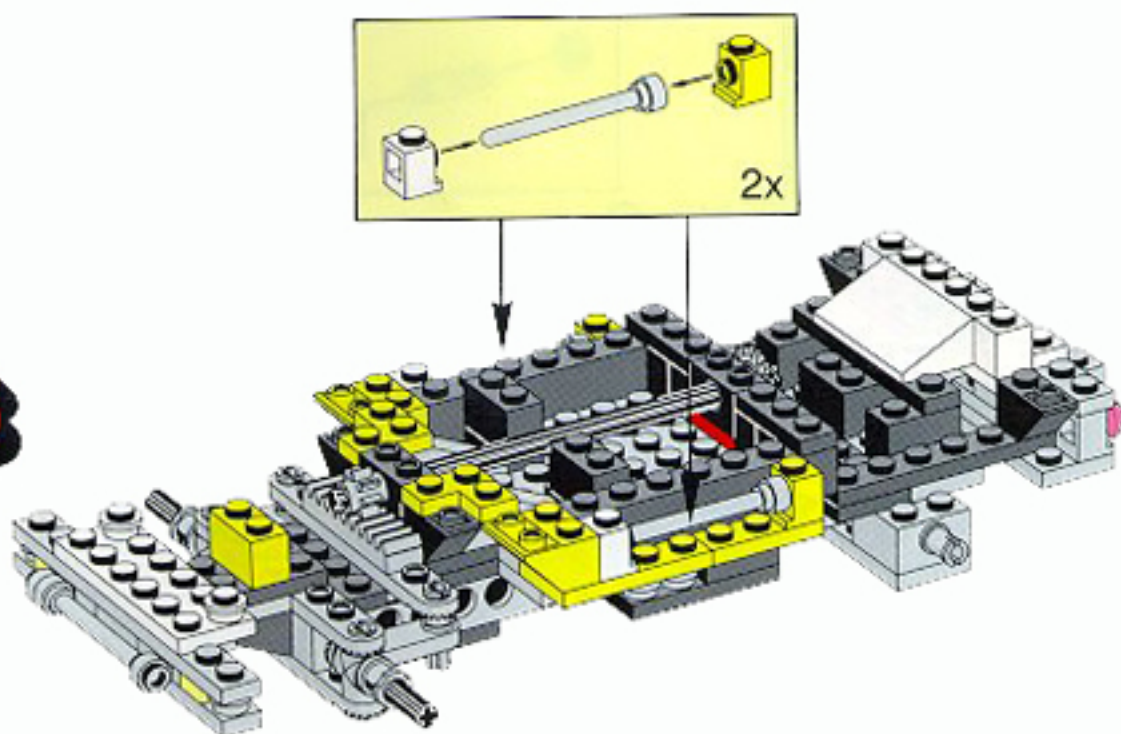

9

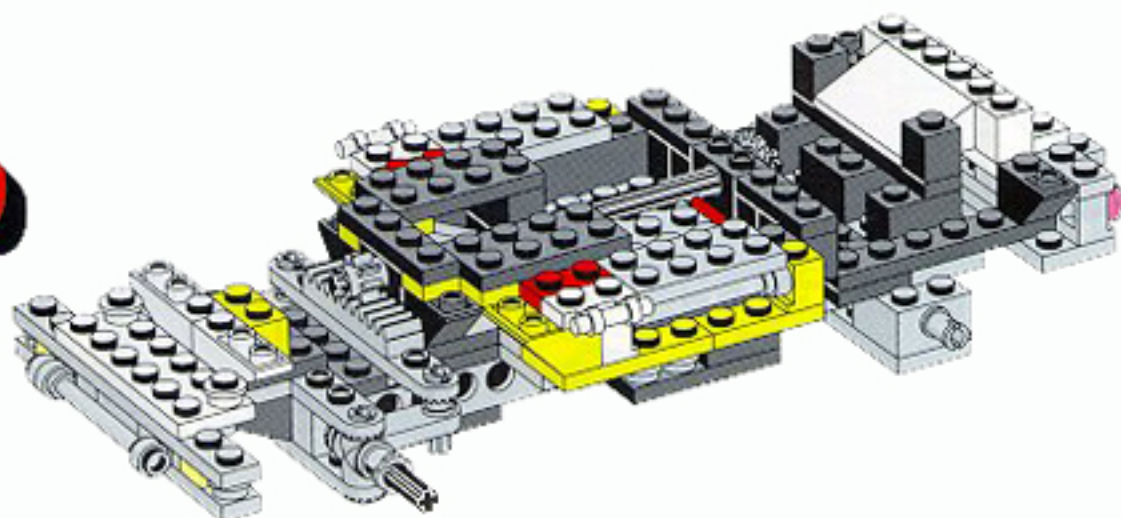



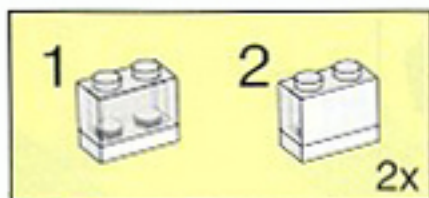

10

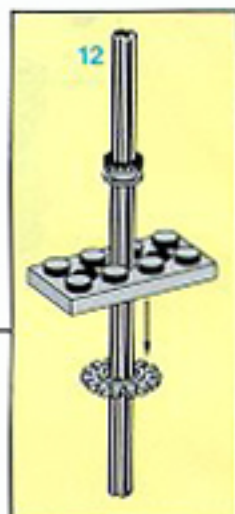
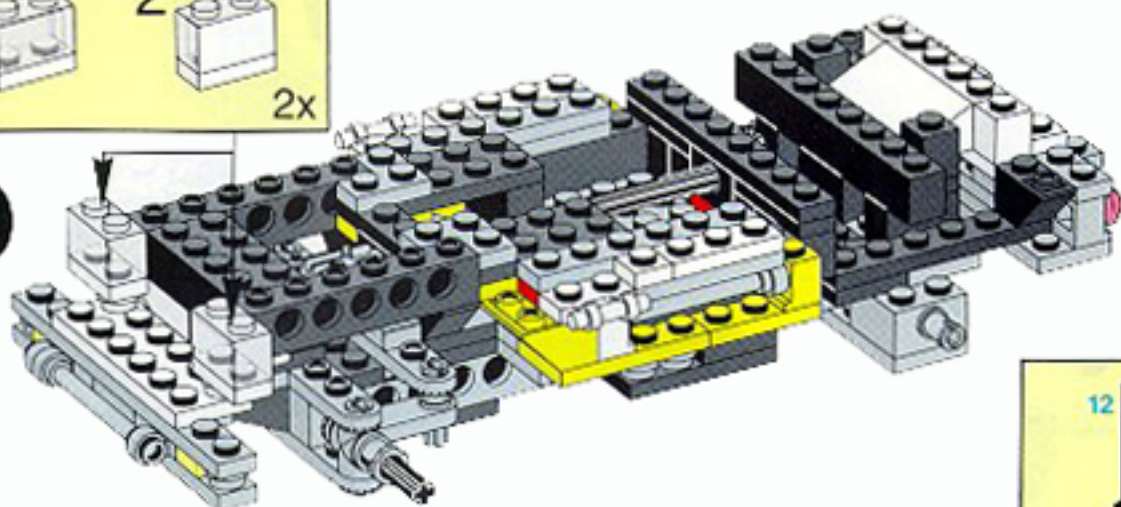

11

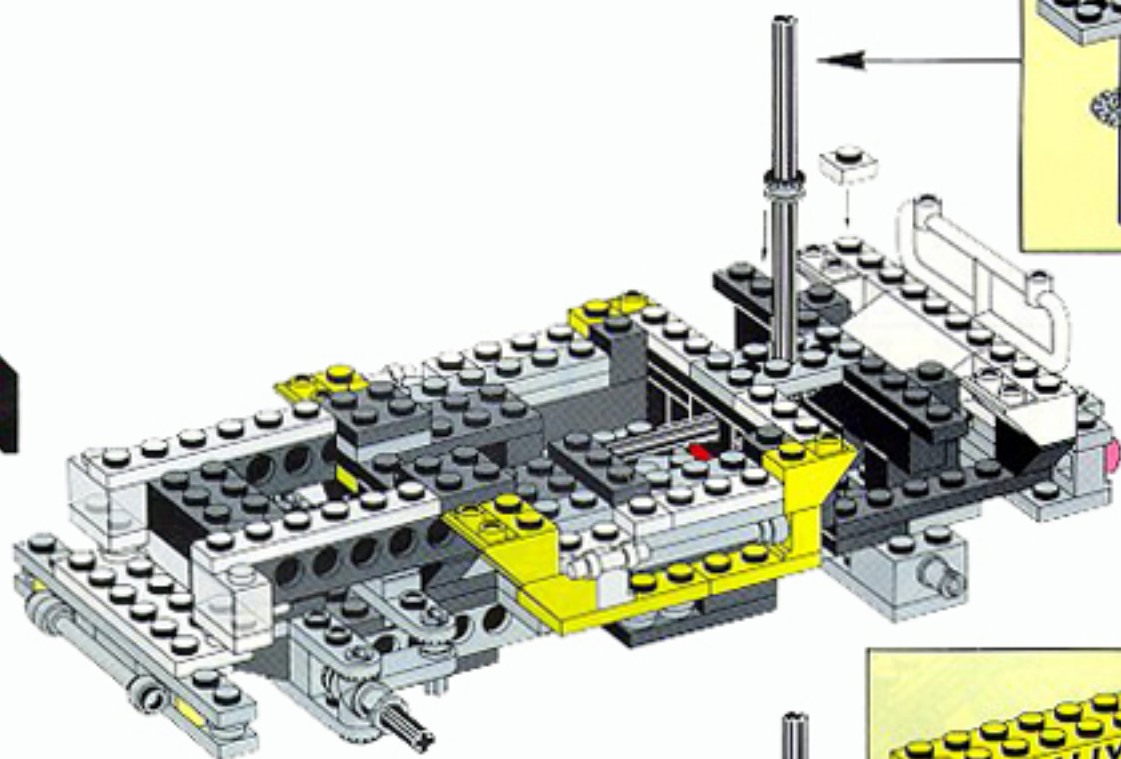

12

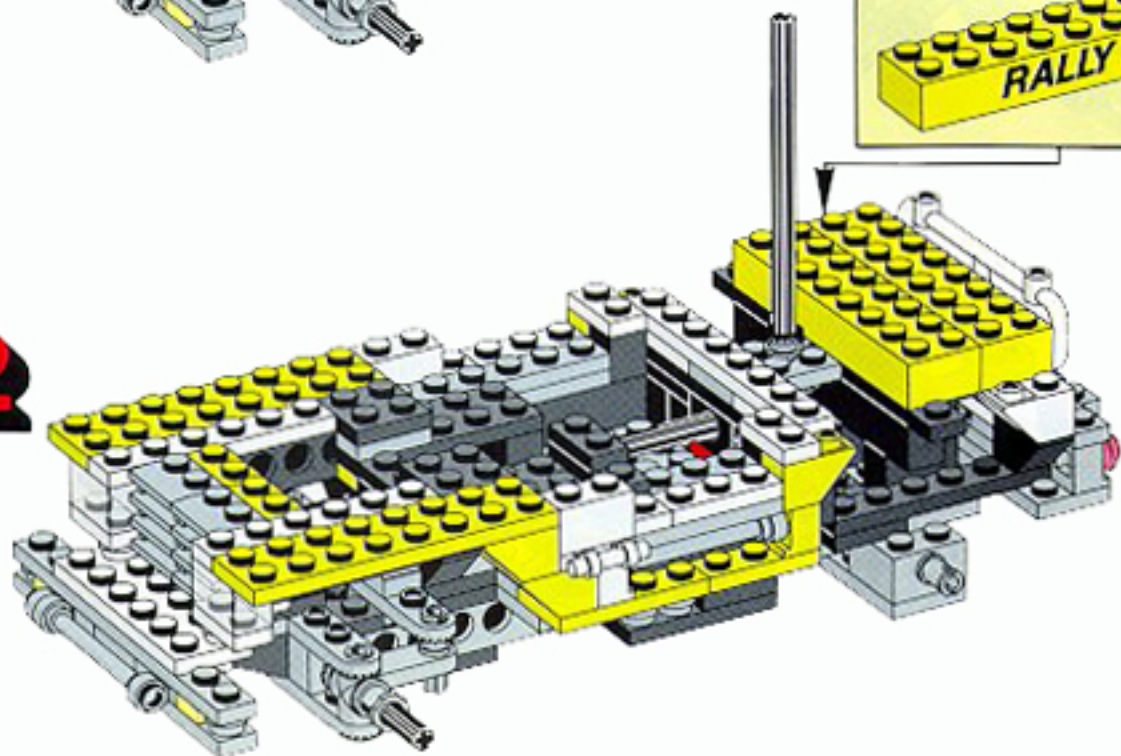



**13**

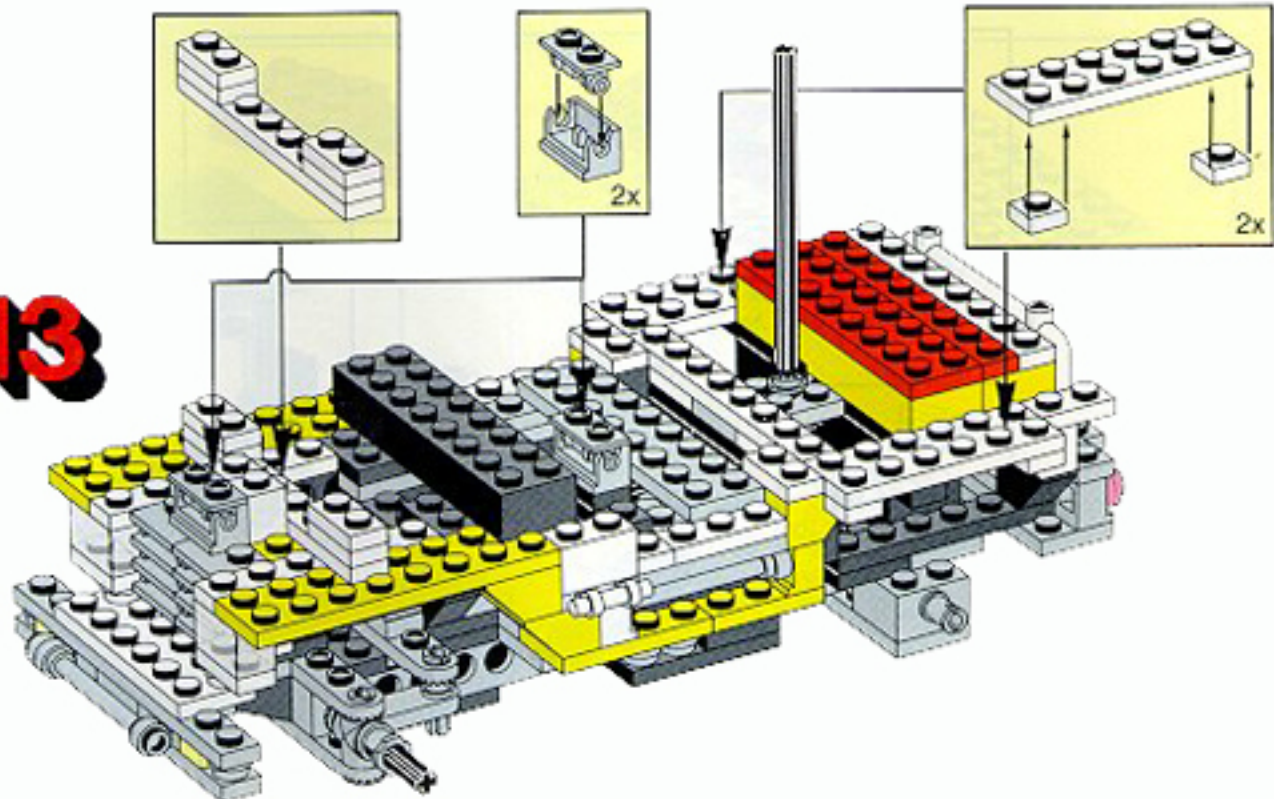

**14**

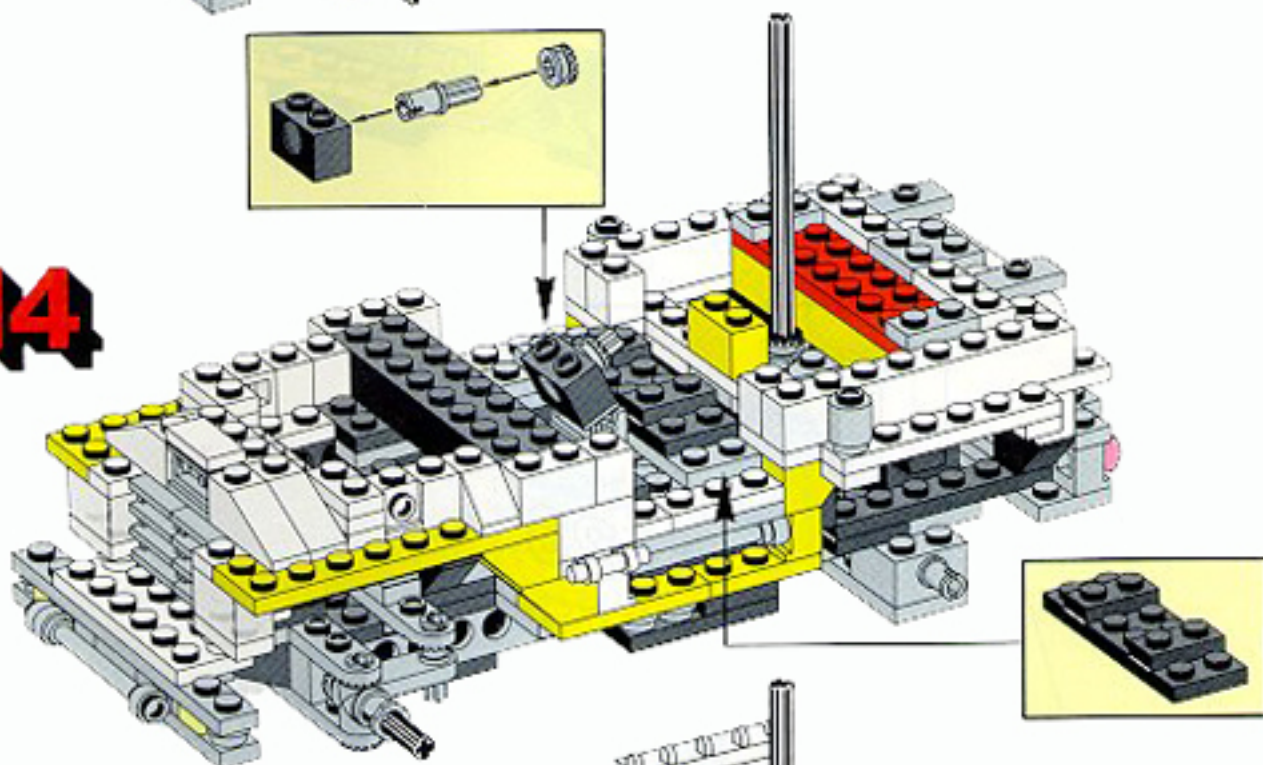

**15**

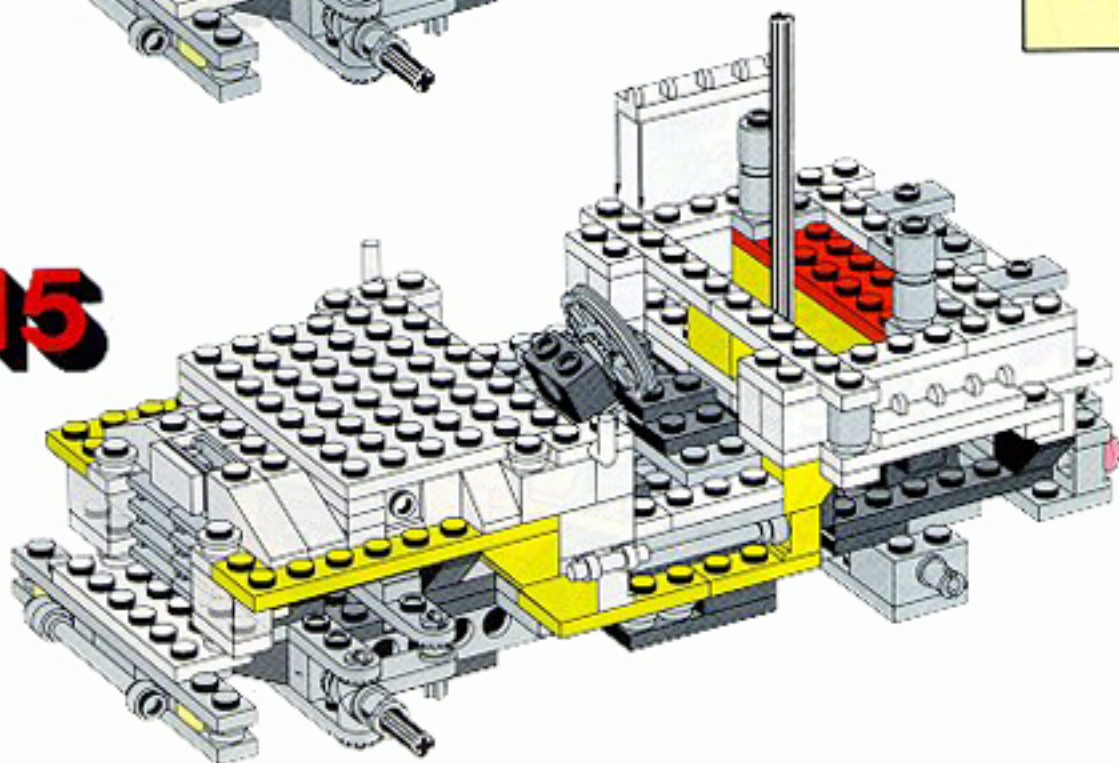



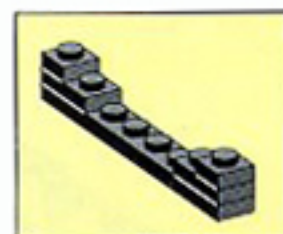

**16**

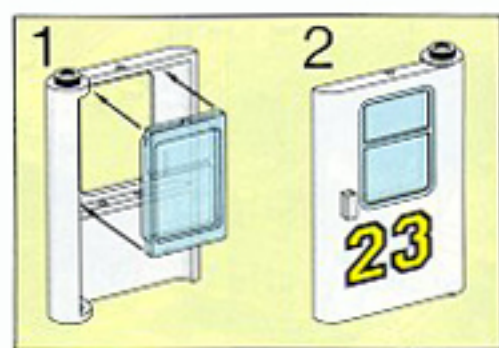
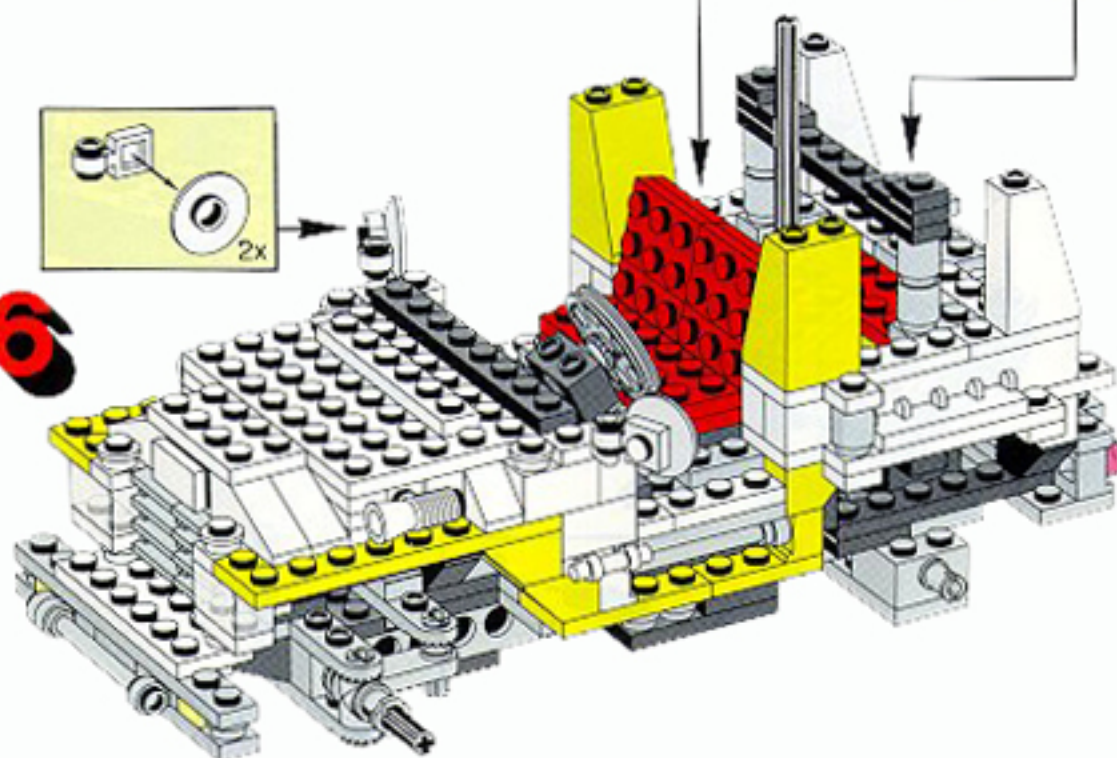

**17**

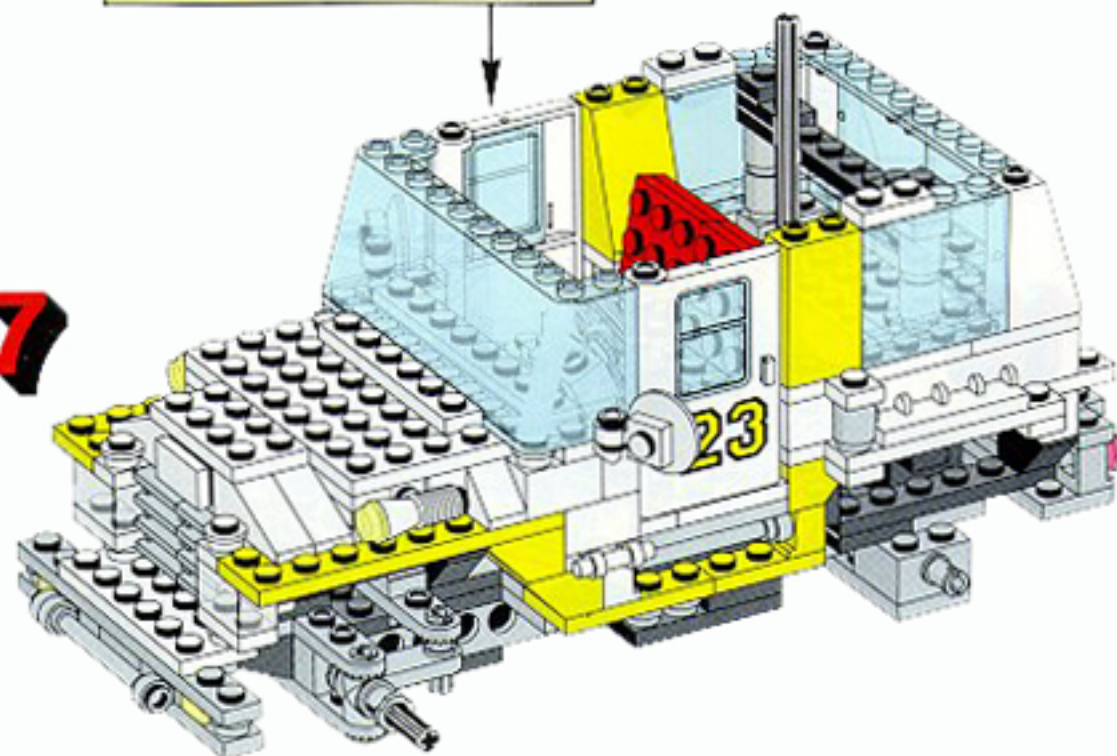



1

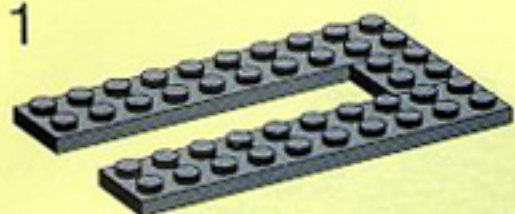

2

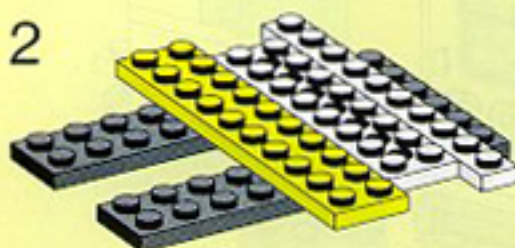

3

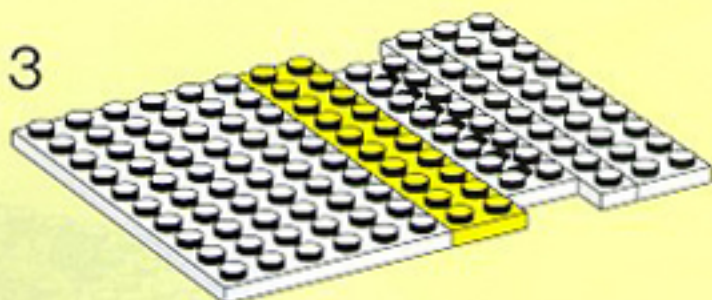

4

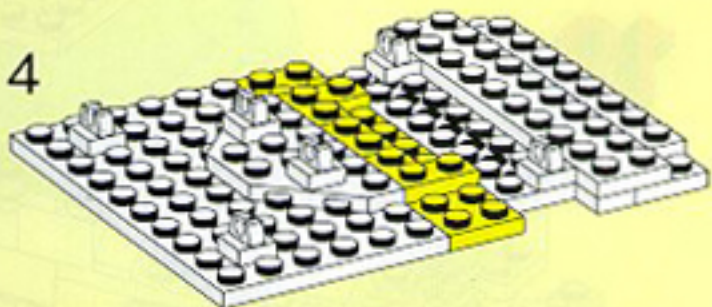
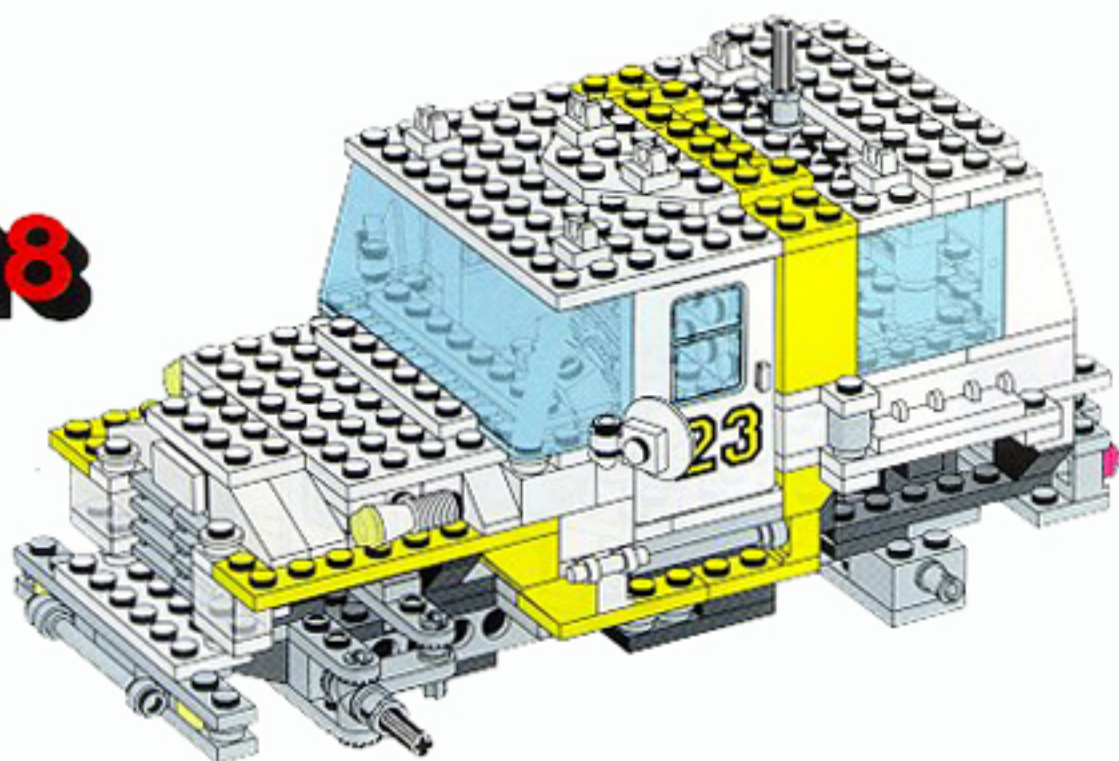
**18**



**19**

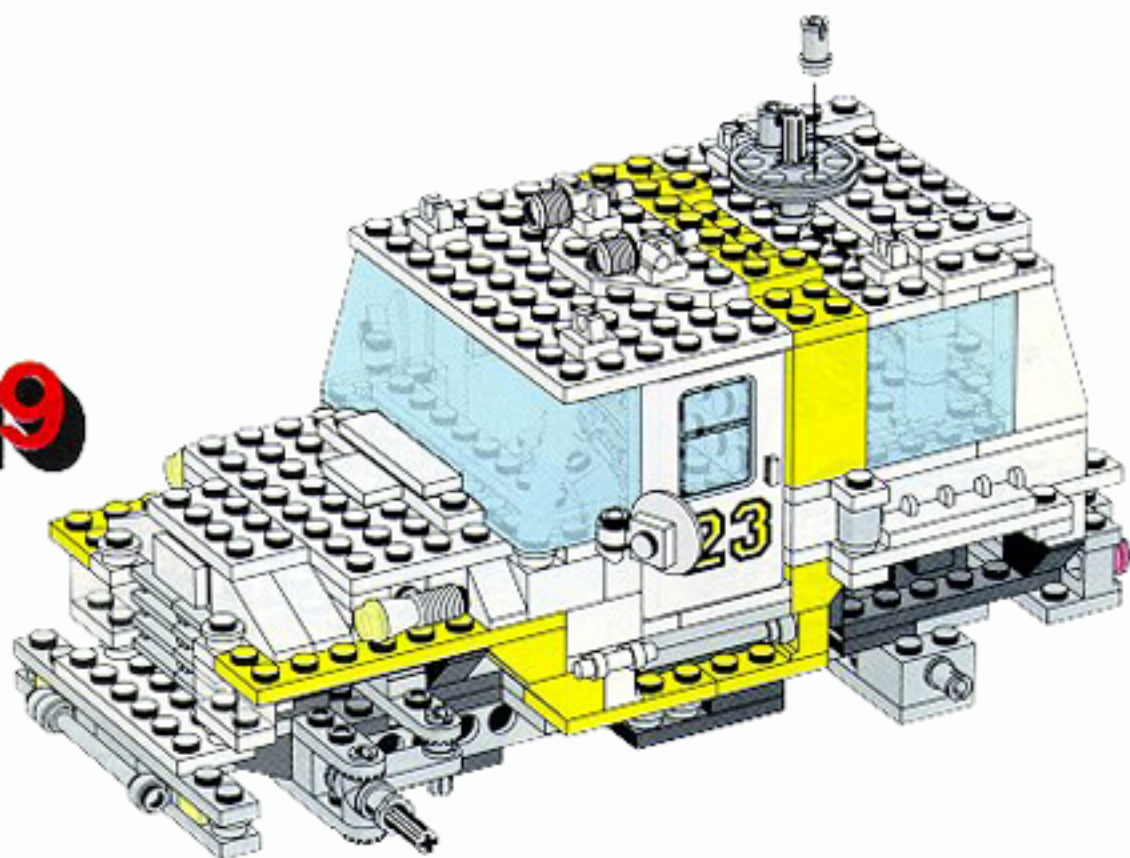

**20**

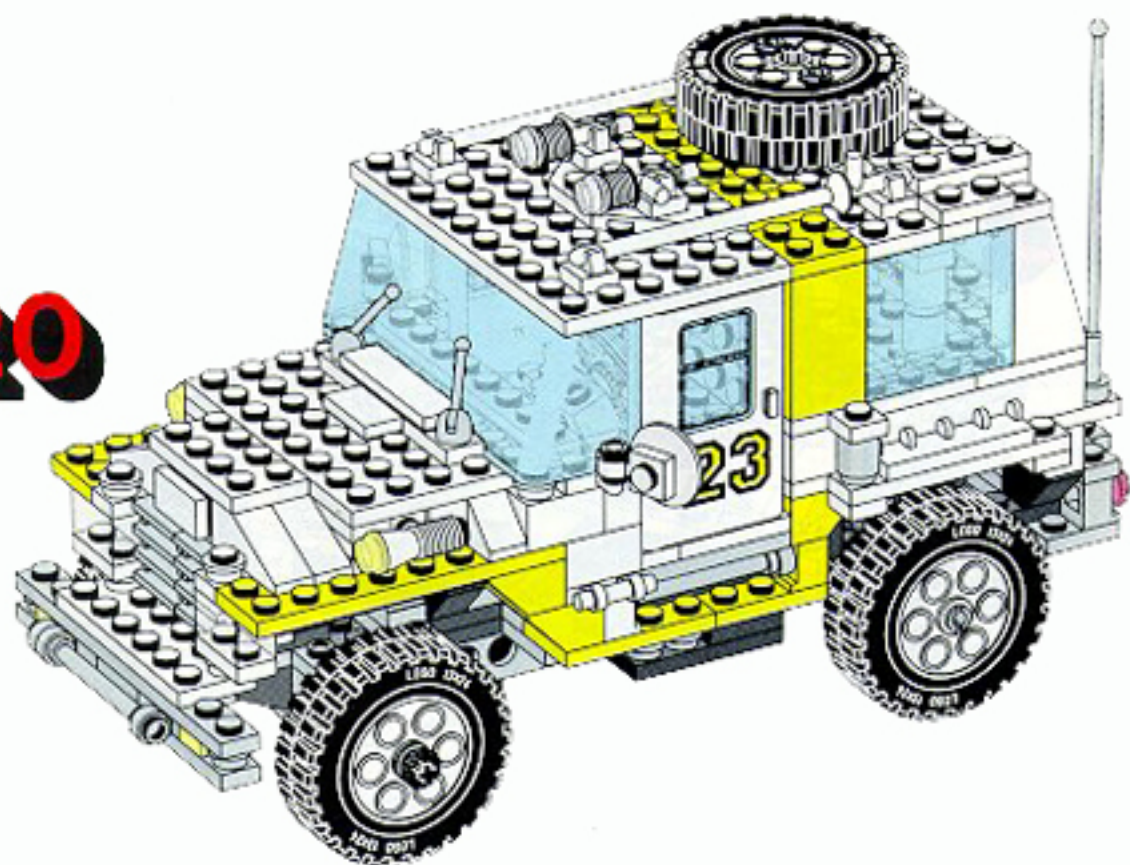



**CUSTOM**  
**CUSTOM**

**RALLY VAN**  
**RALLY VAN**











MT  
5550

**CUSTOM**  
RALLY VAN  
**CUSTOM**  
RALLY VAN

MT 5550

**23 23 23**



Image	Qty	Item No	Description	MID
<b>Regular Items:</b>				
<b>Parts:</b>				
+		4	<a href="#">3957</a> <b>Light Gray Antenna 1 x 4</b> <a href="#">Catalog:</a> <a href="#">Parts:</a> <a href="#">Antenna</a>	<a href="#">PG</a>
	*			
+		1	<a href="#">2569</a> <b>Light Gray Antenna Whip 8H</b> <a href="#">Catalog:</a> <a href="#">Parts:</a> <a href="#">Antenna</a>	<a href="#">PG</a>
	*			
+		1	<a href="#">2486</a> <b>White Bar 1 x 8 x 2</b> <a href="#">Catalog:</a> <a href="#">Parts:</a> <a href="#">Bar</a>	<a href="#">PG</a>
	*			
+		8	<a href="#">3005</a> <b>Black Brick 1 x 1</b> <a href="#">Catalog:</a> <a href="#">Parts:</a> <a href="#">Brick</a>	<a href="#">PG</a>
	*			
+		16	<a href="#">3005</a> <b>White Brick 1 x 1</b> <a href="#">Catalog:</a> <a href="#">Parts:</a> <a href="#">Brick</a>	<a href="#">PG</a>
	*			
+		10	<a href="#">3004</a> <b>Black Brick 1 x 2</b> <a href="#">Catalog:</a> <a href="#">Parts:</a> <a href="#">Brick</a>	<a href="#">PG</a>
	*			
+		4	<a href="#">3004</a> <b>White Brick 1 x 2</b> <a href="#">Catalog:</a> <a href="#">Parts:</a> <a href="#">Brick</a>	<a href="#">PG</a>
	*			
+		2	<a href="#">3004</a> <b>Yellow Brick 1 x 2</b> <a href="#">Catalog:</a> <a href="#">Parts:</a> <a href="#">Brick</a>	<a href="#">PG</a>
	*			
+		2	<a href="#">3065</a> <b>Trans-Clear Brick 1 x 2 without Bottom Tube</b> <a href="#">Catalog:</a> <a href="#">Parts:</a> <a href="#">Brick</a>	<a href="#">PG</a>
	*			
+		4	<a href="#">3009</a> <b>Black Brick 1 x 6</b> <a href="#">Catalog:</a> <a href="#">Parts:</a> <a href="#">Brick</a>	<a href="#">PG</a>
	*			
+		1	<a href="#">3008</a> <b>Black Brick 1 x 8</b> <a href="#">Catalog:</a> <a href="#">Parts:</a> <a href="#">Brick</a>	<a href="#">PG</a>
	*			



+		2	<a href="#">3008</a>	<b>White Brick 1 x 8</b> <a href="#">Catalog:</a> <a href="#">Parts:</a> <a href="#">Brick</a>	<a href="#">PG</a>
---	--	---	----------------------	---	--------------------

+		2	<a href="#">3001</a>	<b>Black Brick 2 x 4</b> <a href="#">Catalog:</a> <a href="#">Parts:</a> <a href="#">Brick</a>	<a href="#">PG</a>
---	---	---	----------------------	---	--------------------

+		2	<a href="#">3007</a>	<b>Black Brick 2 x 8</b> <a href="#">Catalog:</a> <a href="#">Parts:</a> <a href="#">Brick</a>	<a href="#">PG</a>
---	---	---	----------------------	---	--------------------

+		2	<a href="#">3007</a>	<b>Yellow Brick 2 x 8</b> <a href="#">Catalog:</a> <a href="#">Parts:</a> <a href="#">Brick</a>	<a href="#">PG</a>
---	---	---	----------------------	--	--------------------

+		8	<a href="#">4070</a>	<b>Light Gray Brick, Modified 1 x 1 with Headlight</b> <a href="#">Catalog:</a> <a href="#">Parts:</a> <a href="#">Brick, Modified</a>	<a href="#">PG</a>
---	---	---	----------------------	---	--------------------

+		4	<a href="#">4070</a>	<b>White Brick, Modified 1 x 1 with Headlight</b> <a href="#">Catalog:</a> <a href="#">Parts:</a> <a href="#">Brick, Modified</a>	<a href="#">PG</a>
---	--	---	----------------------	--	--------------------

+		4	<a href="#">4070</a>	<b>Yellow Brick, Modified 1 x 1 with Headlight</b> <a href="#">Catalog:</a> <a href="#">Parts:</a> <a href="#">Brick, Modified</a>	<a href="#">PG</a>
---	---	---	----------------------	---	--------------------

+		2	<a href="#">4730</a>	<b>Light Gray Brick, Modified 2 x 2 with Pin and No Axle Hole</b> <a href="#">Catalog:</a> <a href="#">Parts:</a> <a href="#">Brick, Modified</a>	<a href="#">PG</a>
---	---	---	----------------------	--	--------------------

+		14	<a href="#">3062b</a>	<b>Light Gray Brick, Round 1 x 1 Open Stud</b> <a href="#">Catalog:</a> <a href="#">Parts:</a> <a href="#">Brick, Round</a>	<a href="#">PG</a>
---	---	----	-----------------------	--	--------------------

+		4	<a href="#">3063</a>	<b>Light Gray Brick, Round Corner 2 x 2 Macaroni with Stud Notch</b> <a href="#">Catalog:</a> <a href="#">Parts:</a> <a href="#">Brick, Round</a>	<a href="#">PG</a>
---	---	---	----------------------	--	--------------------

+		2	<a href="#">3063</a>	<b>White Brick, Round Corner 2 x 2 Macaroni with Stud Notch</b> <a href="#">Catalog:</a> <a href="#">Parts:</a> <a href="#">Brick, Round</a>	<a href="#">PG</a>
---	---	---	----------------------	---	--------------------

+		2	<a href="#">4740</a>	<b>White Dish 2 x 2 Inverted (Radar)</b> <a href="#">Catalog:</a> <a href="#">Parts:</a> <a href="#">Dish</a>	<a href="#">PG</a>
---	---	---	----------------------	--	--------------------



+



2

[4181](#)

**White Door 1 x 4 x 5 Train Left**

[Catalog](#): [Parts](#): [Door](#)

[PG](#)

\*

+



2

[4182](#)

**White Door 1 x 4 x 5 Train Right**

[Catalog](#): [Parts](#): [Door](#)

[PG](#)

\*

+



4

[4183](#)

**Trans-Light Blue Glass for Train Door with Lip on Top and Bottom**

[Catalog](#): [Parts](#): [Glass](#)

[PG](#)

\*

+



3

[3937](#)

**Light Gray Hinge Brick 1 x 2 Base**

[Catalog](#): [Parts](#): [Hinge](#)

[PG](#)

\*

+



3

[3938](#)

**Light Gray Hinge Brick 1 x 2 Top**

[Catalog](#): [Parts](#): [Hinge](#)

[PG](#)

\*

+

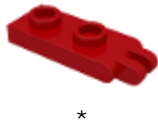

6

[4276](#)

**Red Hinge Plate 1 x 2 with 2 Fingers**

[Catalog](#): [Parts](#): [Hinge](#)

[PG](#)

\*

+

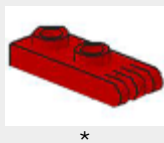

6

[4275](#)

**Red Hinge Plate 1 x 2 with 3 Fingers**

[Catalog](#): [Parts](#): [Hinge](#)

[PG](#)

\*

+

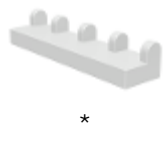

2

[4625](#)

**White Hinge Tile 1 x 4**

[Catalog](#): [Parts](#): [Hinge](#)

[PG](#)

\*

+



2

[4213](#)

**White Hinge Vehicle Roof 4 x 4**

[Catalog](#): [Parts](#): [Hinge](#)

[PG](#)

\*

+



2

[4592c03](#) (inv)

**Light Gray Lever Small Base with Light Gray Lever**

[Catalog](#): [Parts](#): [Lever](#)

[PG](#)

\*

+



2

[4349](#)

**White Minifigure, Utensil Loudhailer / Megaphone / SW Blaster**

[Catalog](#): [Parts](#): [Minifigure](#), [Utensil](#)

[PG](#)

\*

+



2

[3959](#)













**White Minifigure, Utensil Space Gun / Torch**

[Catalog](#): [Parts](#): [Minifigure](#), [Utensil](#)

[PG](#)

\*



+	 *	2	<a href="#">3849</a>	<b>White Minifigure, Weapon Lance</b> <a href="#">Catalog:</a> <a href="#">Parts:</a> <a href="#">Minifigure:</a> <a href="#">Weapon</a>	<a href="#">PG</a>
+	 *	4	<a href="#">4215a</a>	<b>Trans-Light Blue Panel 1 x 4 x 3 - Solid Studs</b> <a href="#">Catalog:</a> <a href="#">Parts:</a> <a href="#">Panel</a>	<a href="#">PG</a>
+	 *	10	<a href="#">3024</a>	<b>Black Plate 1 x 1</b> <a href="#">Catalog:</a> <a href="#">Parts:</a> <a href="#">Plate</a>	<a href="#">PG</a>
+	 *	6	<a href="#">3024</a>	<b>Trans-Yellow Plate 1 x 1</b> <a href="#">Catalog:</a> <a href="#">Parts:</a> <a href="#">Plate</a>	<a href="#">PG</a>
+	 *	14	<a href="#">3024</a>	<b>White Plate 1 x 1</b> <a href="#">Catalog:</a> <a href="#">Parts:</a> <a href="#">Plate</a>	<a href="#">PG</a>
+	 *	10	<a href="#">3023</a>	<b>Black Plate 1 x 2</b> <a href="#">Catalog:</a> <a href="#">Parts:</a> <a href="#">Plate</a>	<a href="#">PG</a>
+	 *	9	<a href="#">3023</a>	<b>Light Gray Plate 1 x 2</b> <a href="#">Catalog:</a> <a href="#">Parts:</a> <a href="#">Plate</a>	<a href="#">PG</a>
+	 *	4	<a href="#">3023</a>	<b>Red Plate 1 x 2</b> <a href="#">Catalog:</a> <a href="#">Parts:</a> <a href="#">Plate</a>	<a href="#">PG</a>
+	 *	15	<a href="#">3023</a>	<b>White Plate 1 x 2</b> <a href="#">Catalog:</a> <a href="#">Parts:</a> <a href="#">Plate</a>	<a href="#">PG</a>
+	 *	10	<a href="#">3023</a>	<b>Yellow Plate 1 x 2</b> <a href="#">Catalog:</a> <a href="#">Parts:</a> <a href="#">Plate</a>	<a href="#">PG</a>
+	 *	6	<a href="#">3623</a>	<b>Black Plate 1 x 3</b> <a href="#">Catalog:</a> <a href="#">Parts:</a> <a href="#">Plate</a>	<a href="#">PG</a>
+	 *	2	<a href="#">3623</a>	<b>Light Gray Plate 1 x 3</b> <a href="#">Catalog:</a> <a href="#">Parts:</a> <a href="#">Plate</a>	<a href="#">PG</a>





+		6	<a href="#">3623</a>	<b>Red Plate 1 x 3</b> <a href="#">Catalog:</a> <a href="#">Parts:</a> <a href="#">Plate</a>	<a href="#">PG</a>
---	--	---	----------------------	---	--------------------

+		13	<a href="#">3623</a>	<b>White Plate 1 x 3</b> <a href="#">Catalog:</a> <a href="#">Parts:</a> <a href="#">Plate</a>	<a href="#">PG</a>
---	---	----	----------------------	---	--------------------

+		9	<a href="#">3710</a>	<b>Black Plate 1 x 4</b> <a href="#">Catalog:</a> <a href="#">Parts:</a> <a href="#">Plate</a>	<a href="#">PG</a>
---	---	---	----------------------	---	--------------------

+		4	<a href="#">3710</a>	<b>Light Gray Plate 1 x 4</b> <a href="#">Catalog:</a> <a href="#">Parts:</a> <a href="#">Plate</a>	<a href="#">PG</a>
---	---	---	----------------------	--	--------------------

+		1	<a href="#">3710</a>	<b>White Plate 1 x 4</b> <a href="#">Catalog:</a> <a href="#">Parts:</a> <a href="#">Plate</a>	<a href="#">PG</a>
---	---	---	----------------------	---	--------------------

+		5	<a href="#">3666</a>	<b>Black Plate 1 x 6</b> <a href="#">Catalog:</a> <a href="#">Parts:</a> <a href="#">Plate</a>	<a href="#">PG</a>
---	--	---	----------------------	---	--------------------

+		5	<a href="#">3666</a>	<b>Light Gray Plate 1 x 6</b> <a href="#">Catalog:</a> <a href="#">Parts:</a> <a href="#">Plate</a>	<a href="#">PG</a>
---	---	---	----------------------	--	--------------------

+		7	<a href="#">3666</a>	<b>White Plate 1 x 6</b> <a href="#">Catalog:</a> <a href="#">Parts:</a> <a href="#">Plate</a>	<a href="#">PG</a>
---	---	---	----------------------	---	--------------------

+		2	<a href="#">3666</a>	<b>Yellow Plate 1 x 6</b> <a href="#">Catalog:</a> <a href="#">Parts:</a> <a href="#">Plate</a>	<a href="#">PG</a>
---	---	---	----------------------	--	--------------------

+		7	<a href="#">3460</a>	<b>Black Plate 1 x 8</b> <a href="#">Catalog:</a> <a href="#">Parts:</a> <a href="#">Plate</a>	<a href="#">PG</a>
---	---	---	----------------------	---	--------------------

+		1	<a href="#">3460</a>	<b>Red Plate 1 x 8</b> <a href="#">Catalog:</a> <a href="#">Parts:</a> <a href="#">Plate</a>	<a href="#">PG</a>
---	---	---	----------------------	---	--------------------

+		8	<a href="#">3460</a>	<b>White Plate 1 x 8</b> <a href="#">Catalog:</a> <a href="#">Parts:</a> <a href="#">Plate</a>	<a href="#">PG</a>
---	---	---	----------------------	---	--------------------



+



\*

6

[4477](#)

**Black Plate 1 x 10**

[Catalog:](#) [Parts:](#) [Plate](#)

[PG](#)

+



\*

2

[4477](#)

**Light Gray Plate 1 x 10**

[Catalog:](#) [Parts:](#) [Plate](#)

[PG](#)

+



\*

1

[4477](#)

**White Plate 1 x 10**

[Catalog:](#) [Parts:](#) [Plate](#)

[PG](#)

+



\*

3

[3022](#)

**Black Plate 2 x 2**

[Catalog:](#) [Parts:](#) [Plate](#)

[PG](#)

+

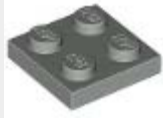

\*

3

[3022](#)

**Light Gray Plate 2 x 2**

[Catalog:](#) [Parts:](#) [Plate](#)

[PG](#)

+



\*

2

[3022](#)

**Red Plate 2 x 2**

[Catalog:](#) [Parts:](#) [Plate](#)

[PG](#)

+



\*

2

[3022](#)

**Yellow Plate 2 x 2**

[Catalog:](#) [Parts:](#) [Plate](#)

[PG](#)

+



\*

4

[2420](#)

**Light Gray Plate 2 x 2 Corner**

[Catalog:](#) [Parts:](#) [Plate](#)

[PG](#)

+



\*

4

[2420](#)

**Yellow Plate 2 x 2 Corner**

[Catalog:](#) [Parts:](#) [Plate](#)

[PG](#)

+



\*

2

[3021](#)

**Black Plate 2 x 3**

[Catalog:](#) [Parts:](#) [Plate](#)

[PG](#)

+



\*

2

[3021](#)

**Light Gray Plate 2 x 3**

[Catalog:](#) [Parts:](#) [Plate](#)

[PG](#)

+

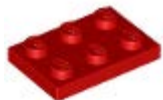

\*

4

[3021](#)

**Red Plate 2 x 3**

[Catalog:](#) [Parts:](#) [Plate](#)

[PG](#)



+



\*

2

[3021](#)

**Yellow Plate 2 x 3**

[Catalog:](#) [Parts:](#) [Plate](#)

[PG](#)

+



\*

5

[3020](#)

**Black Plate 2 x 4**

[Catalog:](#) [Parts:](#) [Plate](#)

[PG](#)

+



\*

3

[3020](#)

**Light Gray Plate 2 x 4**

[Catalog:](#) [Parts:](#) [Plate](#)

[PG](#)

+



\*

1

[3020](#)

**White Plate 2 x 4**

[Catalog:](#) [Parts:](#) [Plate](#)

[PG](#)

+



\*

2

[3020](#)

**Yellow Plate 2 x 4**

[Catalog:](#) [Parts:](#) [Plate](#)

[PG](#)

+



\*

1

[3795](#)

**Black Plate 2 x 6**

[Catalog:](#) [Parts:](#) [Plate](#)

[PG](#)

+



\*

3

[3795](#)

**White Plate 2 x 6**

[Catalog:](#) [Parts:](#) [Plate](#)

[PG](#)

+



\*

5

[3034](#)

**Light Gray Plate 2 x 8**

[Catalog:](#) [Parts:](#) [Plate](#)

[PG](#)

+



\*

2

[3034](#)

**Red Plate 2 x 8**

[Catalog:](#) [Parts:](#) [Plate](#)

[PG](#)

+



\*

3

[3034](#)

**Yellow Plate 2 x 8**

[Catalog:](#) [Parts:](#) [Plate](#)

[PG](#)

+



\*

3

[3832](#)

**Black Plate 2 x 10**

[Catalog:](#) [Parts:](#) [Plate](#)

[PG](#)

+



\*

2

[3832](#)

**Light Gray Plate 2 x 10**

[Catalog:](#) [Parts:](#) [Plate](#)

[PG](#)



+		2	<a href="#">3832</a>	<b>White Plate 2 x 10</b> <a href="#">Catalog: Parts: Plate</a>	<a href="#">PG</a>
---	--	---	----------------------	--	--------------------

\*

+		3	<a href="#">3832</a>	<b>Yellow Plate 2 x 10</b> <a href="#">Catalog: Parts: Plate</a>	<a href="#">PG</a>
---	---	---	----------------------	---	--------------------

\*

+		1	<a href="#">3031</a>	<b>Black Plate 4 x 4</b> <a href="#">Catalog: Parts: Plate</a>	<a href="#">PG</a>
---	---	---	----------------------	---	--------------------

\*

+		1	<a href="#">3032</a>	<b>Black Plate 4 x 6</b> <a href="#">Catalog: Parts: Plate</a>	<a href="#">PG</a>
---	---	---	----------------------	---	--------------------

\*

+		2	<a href="#">3035</a>	<b>Light Gray Plate 4 x 8</b> <a href="#">Catalog: Parts: Plate</a>	<a href="#">PG</a>
---	---	---	----------------------	--	--------------------

\*

+		1	<a href="#">3036</a>	<b>Light Gray Plate 6 x 8</b> <a href="#">Catalog: Parts: Plate</a>	<a href="#">PG</a>
---	--	---	----------------------	--	--------------------

\*

+		1	<a href="#">3036</a>	<b>White Plate 6 x 8</b> <a href="#">Catalog: Parts: Plate</a>	<a href="#">PG</a>
---	---	---	----------------------	---	--------------------

\*

+		1	<a href="#">3033</a>	<b>White Plate 6 x 10</b> <a href="#">Catalog: Parts: Plate</a>	<a href="#">PG</a>
---	---	---	----------------------	--	--------------------

\*

+		2	<a href="#">4081b</a>	<b>Black Plate, Modified 1 x 1 with Clip Light - Thick Ring</b> <a href="#">Catalog: Parts: Plate, Modified</a>	<a href="#">PG</a>
---	---	---	-----------------------	--	--------------------

\*

+		4	<a href="#">4081b</a>	<b>Light Gray Plate, Modified 1 x 1 with Clip Light - Thick Ring</b> <a href="#">Catalog: Parts: Plate, Modified</a>	<a href="#">PG</a>
---	---	---	-----------------------	---	--------------------

\*

+		2	<a href="#">4081b</a>	<b>White Plate, Modified 1 x 1 with Clip Light - Thick Ring</b> <a href="#">Catalog: Parts: Plate, Modified</a>	<a href="#">PG</a>
---	---	---	-----------------------	--	--------------------

\*

+		3	<a href="#">4085b</a>	<b>White Plate, Modified 1 x 1 with Clip Vertical - Type 2 (thin U clip)</b> <a href="#">Catalog: Parts: Plate, Modified</a>	<a href="#">PG</a>
---	---	---	-----------------------	---	--------------------

\*

+	 *	2	<a href="#">3794a</a>	<b>Light Gray Plate, Modified 1 x 2 with 1 Stud without Groove (Jumper)</b> <a href="#">Catalog:</a> <a href="#">Parts:</a> <a href="#">Plate:</a> <a href="#">Modified</a>	<a href="#">PG</a>
---	-------	---	-----------------------	--	--------------------

+	 *	2	<a href="#">4623</a>	<b>White Plate, Modified 1 x 2 with Arm Up (Horizontal Arm Length 6mm)</b> <a href="#">Catalog:</a> <a href="#">Parts:</a> <a href="#">Plate:</a> <a href="#">Modified</a>	<a href="#">PG</a>
---	-------	---	----------------------	---	--------------------

+	 *	2	<a href="#">2540</a>	<b>White Plate, Modified 1 x 2 with Handle on Side - Free Ends</b> <a href="#">Catalog:</a> <a href="#">Parts:</a> <a href="#">Plate:</a> <a href="#">Modified</a>	<a href="#">PG</a>
---	-------	---	----------------------	---	--------------------

+	 *	5	<a href="#">4175</a>	<b>Light Gray Plate, Modified 1 x 2 with Ladder</b> <a href="#">Catalog:</a> <a href="#">Parts:</a> <a href="#">Plate:</a> <a href="#">Modified</a>	<a href="#">PG</a>
---	-------	---	----------------------	--	--------------------

+	 *	1	<a href="#">4073c01</a> (inv)	<b>Light Gray Plate, Round 1 x 1, 2 on Sprue</b> <a href="#">Catalog:</a> <a href="#">Parts:</a> <a href="#">Plate:</a> <a href="#">Round</a>	<a href="#">PG</a>
---	-------	---	-------------------------------	--	--------------------

+	 *	2	<a href="#">4073c01</a> (inv)	<b>Trans-Clear Plate, Round 1 x 1, 2 on Sprue</b> <a href="#">Catalog:</a> <a href="#">Parts:</a> <a href="#">Plate:</a> <a href="#">Round</a>	<a href="#">PG</a>
---	-------	---	-------------------------------	---	--------------------

+	 *	2	<a href="#">4073c01</a> (inv)	<b>Trans-Red Plate, Round 1 x 1, 2 on Sprue</b> <a href="#">Catalog:</a> <a href="#">Parts:</a> <a href="#">Plate:</a> <a href="#">Round</a>	<a href="#">PG</a>
---	-------	---	-------------------------------	---	--------------------

+	 *	1	<a href="#">4073c01</a> (inv)	<b>Trans-Yellow Plate, Round 1 x 1, 2 on Sprue</b> <a href="#">Catalog:</a> <a href="#">Parts:</a> <a href="#">Plate:</a> <a href="#">Round</a>	<a href="#">PG</a>
---	-------	---	-------------------------------	--	--------------------













+	 *	3	<a href="#">4073c01</a> (inv)	<b>White Plate, Round 1 x 1, 2 on Sprue</b> <a href="#">Catalog:</a> <a href="#">Parts:</a> <a href="#">Plate:</a> <a href="#">Round</a>	<a href="#">PG</a>
---	-------	---	-------------------------------	---	--------------------













+	 *	2	<a href="#">4286</a>	<b>Light Gray Slope 33 3 x 1</b> <a href="#">Catalog:</a> <a href="#">Parts:</a> <a href="#">Slope</a>	<a href="#">PG</a>
---	-------	---	----------------------	---	--------------------

+	 *	4	<a href="#">4286</a>	<b>White Slope 33 3 x 1</b> <a href="#">Catalog:</a> <a href="#">Parts:</a> <a href="#">Slope</a>	<a href="#">PG</a>
---	-------	---	----------------------	--	--------------------

+	 *	1	<a href="#">3297</a>	<b>White Slope 33 3 x 4</b> <a href="#">Catalog:</a> <a href="#">Parts:</a> <a href="#">Slope</a>	<a href="#">PG</a>
---	-------	---	----------------------	--	--------------------



+		2	<a href="#">3040</a>	<b>White Slope 45 2 x 1</b> <a href="#">Catalog:</a> <a href="#">Parts:</a> <a href="#">Slope</a>	<a href="#">PG</a>
	*				
+		2	<a href="#">4460a</a>	<b>White Slope 75 2 x 1 x 3 - Open Stud</b> <a href="#">Catalog:</a> <a href="#">Parts:</a> <a href="#">Slope</a>	<a href="#">PG</a>
	*				
+		2	<a href="#">3684a</a>	<b>Yellow Slope 75 2 x 2 x 3 - Hollow Studs</b> <a href="#">Catalog:</a> <a href="#">Parts:</a> <a href="#">Slope</a>	<a href="#">PG</a>
	*				
+		2	<a href="#">4287</a>	<b>Black Slope, Inverted 33 3 x 1</b> <a href="#">Catalog:</a> <a href="#">Parts:</a> <a href="#">Slope,</a> <a href="#">Inverted</a>	<a href="#">PG</a>
	*				
+		2	<a href="#">4287</a>	<b>White Slope, Inverted 33 3 x 1</b> <a href="#">Catalog:</a> <a href="#">Parts:</a> <a href="#">Slope,</a> <a href="#">Inverted</a>	<a href="#">PG</a>
	*				
+		1	<a href="#">3747a</a>	<b>Black Slope, Inverted 33 3 x 2 without Connections between Studs</b> <a href="#">Catalog:</a> <a href="#">Parts:</a> <a href="#">Slope,</a> <a href="#">Inverted</a>	<a href="#">PG</a>
	*				
+		4	<a href="#">3665</a>	<b>Black Slope, Inverted 45 2 x 1</b> <a href="#">Catalog:</a> <a href="#">Parts:</a> <a href="#">Slope,</a> <a href="#">Inverted</a>	<a href="#">PG</a>
	*				
+		2	<a href="#">3665</a>	<b>Yellow Slope, Inverted 45 2 x 1</b> <a href="#">Catalog:</a> <a href="#">Parts:</a> <a href="#">Slope,</a> <a href="#">Inverted</a>	<a href="#">PG</a>
	*				
+		2	<a href="#">3660</a>	<b>White Slope, Inverted 45 2 x 2</b> <a href="#">Catalog:</a> <a href="#">Parts:</a> <a href="#">Slope,</a> <a href="#">Inverted</a>	<a href="#">PG</a>
	*				
+		4	<a href="#">3660</a>	<b>Yellow Slope, Inverted 45 2 x 2</b> <a href="#">Catalog:</a> <a href="#">Parts:</a> <a href="#">Slope,</a> <a href="#">Inverted</a>	<a href="#">PG</a>
	*				
+		2	<a href="#">2341</a>	<b>Black Slope, Inverted 45 3 x 1 Double</b> <a href="#">Catalog:</a> <a href="#">Parts:</a> <a href="#">Slope,</a> <a href="#">Inverted</a>	<a href="#">PG</a>
	*				
+		1	<a href="#">5550stk01</a>	<b>Sticker for Set 5550 - (162275)</b> <a href="#">Catalog:</a> <a href="#">Parts:</a> <a href="#">Sticker</a>	<a href="#">PG</a>
	*				

+	 *	4	<a href="#">3713</a>	<b>Light Gray Technic Bush</b> <a href="#">Catalog:</a> <a href="#">Parts:</a> <a href="#">Technic</a>	<a href="#">PG</a>
+	 *	7	<a href="#">4265a</a>	<b>Light Gray Technic Bush 1/2 Toothed Type I</b> <a href="#">Catalog:</a> <a href="#">Parts:</a> <a href="#">Technic</a>	<a href="#">PG</a>
+	 *	2	<a href="#">4185</a>	<b>Light Gray Technic Wedge Belt Wheel (Pulley)</b> <a href="#">Catalog:</a> <a href="#">Parts:</a> <a href="#">Technic</a>	<a href="#">PG</a>
+	 *	2	<a href="#">3705</a>	<b>Black Technic, Axle 4</b> <a href="#">Catalog:</a> <a href="#">Parts:</a> <a href="#">Technic,</a> <a href="#">Axle</a>	<a href="#">PG</a>
+	 *	2	<a href="#">3708</a>	<b>Black Technic, Axle 12</b> <a href="#">Catalog:</a> <a href="#">Parts:</a> <a href="#">Technic,</a> <a href="#">Axle</a>	<a href="#">PG</a>
+	 *	3	<a href="#">3749</a>	<b>Light Gray Technic, Axle Pin without Friction Ridges Lengthwise</b> <a href="#">Catalog:</a> <a href="#">Parts:</a> <a href="#">Technic,</a> <a href="#">Axle</a>	<a href="#">PG</a>
+	 *	3	<a href="#">3700</a>	<b>Black Technic, Brick 1 x 2 with Hole</b> <a href="#">Catalog:</a> <a href="#">Parts:</a> <a href="#">Technic,</a> <a href="#">Brick</a>	<a href="#">PG</a>
+	 *	2	<a href="#">3894</a>	<b>Black Technic, Brick 1 x 6 with Holes</b> <a href="#">Catalog:</a> <a href="#">Parts:</a> <a href="#">Technic,</a> <a href="#">Brick</a>	<a href="#">PG</a>
+	 *	2	<a href="#">3703</a>	<b>Light Gray Technic, Brick 1 x 16 with Holes</b> <a href="#">Catalog:</a> <a href="#">Parts:</a> <a href="#">Technic,</a> <a href="#">Brick</a>	<a href="#">PG</a>
+	 *	1	<a href="#">3647</a>	<b>Light Gray Technic, Gear 8 Tooth Type 1</b> <a href="#">Catalog:</a> <a href="#">Parts:</a> <a href="#">Technic,</a> <a href="#">Gear</a>	<a href="#">PG</a>
+	 *	2	<a href="#">4143</a>	<b>Light Gray Technic, Gear 14 Tooth Bevel</b> <a href="#">Catalog:</a> <a href="#">Parts:</a> <a href="#">Technic,</a> <a href="#">Gear</a>	<a href="#">PG</a>
+	 *	1	<a href="#">3743</a>	<b>Light Gray Technic, Gear Rack 1 x 4</b> <a href="#">Catalog:</a> <a href="#">Parts:</a> <a href="#">Technic,</a> <a href="#">Gear</a>	<a href="#">PG</a>



+		6	<a href="#">4274</a>	<b>Light Gray Technic, Pin 1/2</b> <a href="#">Catalog: Parts: Technic, Pin</a>	<a href="#">PG</a>
---	--	---	----------------------	--	--------------------

\*

+		3	<a href="#">4442</a>	<b>Light Gray Technic, Plate 1 x 8 with Toothed Ends</b> <a href="#">Catalog: Parts: Technic, Plate</a>	<a href="#">PG</a>
---	---	---	----------------------	--	--------------------

\*

+		1	<a href="#">3709b</a>	<b>Light Gray Technic, Plate 2 x 4 with 3 Holes</b> <a href="#">Catalog: Parts: Technic, Plate</a>	<a href="#">PG</a>
---	---	---	-----------------------	---	--------------------

\*

+		1	<a href="#">3738</a>	<b>Black Technic, Plate 2 x 8 with 7 Holes</b> <a href="#">Catalog: Parts: Technic, Plate</a>	<a href="#">PG</a>
---	---	---	----------------------	--	--------------------

\*

+		1	<a href="#">3738</a>	<b>White Technic, Plate 2 x 8 with 7 Holes</b> <a href="#">Catalog: Parts: Technic, Plate</a>	<a href="#">PG</a>
---	---	---	----------------------	--	--------------------

\*

+		2	<a href="#">4261</a>	<b>Light Gray Technic, Steering Arm</b> <a href="#">Catalog: Parts: Technic, Steering</a>	<a href="#">PG</a>
---	---	---	----------------------	--	--------------------

\*

+		2	<a href="#">3070b</a>	<b>Light Gray Tile 1 x 1 with Groove (3070)</b> <a href="#">Catalog: Parts: Tile</a>	<a href="#">PG</a>
---	---	---	-----------------------	---	--------------------

\*

+		1	<a href="#">3069b</a>	<b>Black Tile 1 x 2 with Groove</b> <a href="#">Catalog: Parts: Tile</a>	<a href="#">PG</a>
---	---	---	-----------------------	---	--------------------

\*

+		2	<a href="#">3069b</a>	<b>White Tile 1 x 2 with Groove</b> <a href="#">Catalog: Parts: Tile</a>	<a href="#">PG</a>
---	---	---	-----------------------	---	--------------------

\*

+		2	<a href="#">3069b</a>	<b>Yellow Tile 1 x 2 with Groove</b> <a href="#">Catalog: Parts: Tile</a>	<a href="#">PG</a>
---	---	---	-----------------------	--	--------------------

\*

+		1	<a href="#">2431</a>	<b>Light Gray Tile 1 x 4</b> <a href="#">Catalog: Parts: Tile</a>	<a href="#">PG</a>
---	---	---	----------------------	--	--------------------

\*

+		1	<a href="#">2431</a>	<b>White Tile 1 x 4</b> <a href="#">Catalog: Parts: Tile</a>	<a href="#">PG</a>
---	---	---	----------------------	---	--------------------

\*

+		2	<a href="#">4162</a>	<b>Yellow Tile 1 x 8</b> <a href="#">Catalog:</a> <a href="#">Parts:</a> <a href="#">Tile</a>	<a href="#">PG</a>
---	--	---	----------------------	--	--------------------

+		8	<a href="#">2555</a>	<b>White Tile, Modified 1 x 1 with Clip</b> <a href="#">Catalog:</a> <a href="#">Parts:</a> <a href="#">Tile, Modified</a>	<a href="#">PG</a>
---	---	---	----------------------	---	--------------------

+		1	<a href="#">2419</a>	<b>White Wedge, Plate 3 x 6 Cut Corners</b> <a href="#">Catalog:</a> <a href="#">Parts:</a> <a href="#">Wedge, Plate</a>	<a href="#">PG</a>
---	---	---	----------------------	---	--------------------

+		5	<a href="#">2695c01</a> (inv)	<b>White Wheel 30mm D. x 13mm (13 x 24 Model Team), with Black Tire 13 x 24 Model Team (2695 / 2696)</b> <a href="#">Catalog:</a> <a href="#">Parts:</a> <a href="#">Wheel &amp; Tire Assembly</a>	<a href="#">PG</a>
---	---	---	-------------------------------	---	--------------------

+		1	<a href="#">2694</a>	<b>Trans-Light Blue Windscreen 3 x 10 x 3</b> <a href="#">Catalog:</a> <a href="#">Parts:</a> <a href="#">Windscreen</a>	<a href="#">PG</a>
---	---	---	----------------------	---	--------------------

**Extra Items:**

+		1	<a href="#">4592c03</a> (inv)	<b>Light Gray Lever Small Base with Light Gray Lever</b> <a href="#">Catalog:</a> <a href="#">Parts:</a> <a href="#">Lever</a>	<a href="#">PG</a>
---	--	---	-------------------------------	---	--------------------

+		1	<a href="#">3713</a>	<b>Light Gray Technic Bush</b> <a href="#">Catalog:</a> <a href="#">Parts:</a> <a href="#">Technic</a>	<a href="#">PG</a>
---	---	---	----------------------	---	--------------------

+		1	<a href="#">4265a</a>	<b>Light Gray Technic Bush 1/2 Toothed Type I</b> <a href="#">Catalog:</a> <a href="#">Parts:</a> <a href="#">Technic</a>	<a href="#">PG</a>
---	---	---	-----------------------	--	--------------------

+		1	<a href="#">4274</a>	<b>Light Gray Technic, Pin 1/2</b> <a href="#">Catalog:</a> <a href="#">Parts:</a> <a href="#">Technic, Pin</a>	<a href="#">PG</a>
---	---	---	----------------------	--	--------------------

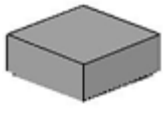





+		1	<a href="#">3070b</a>	<b>Light Gray Tile 1 x 1 with Groove (3070)</b> <a href="#">Catalog:</a> <a href="#">Parts:</a> <a href="#">Tile</a>	<a href="#">PG</a>
---	---	---	-----------------------	---	--------------------

**Counterparts:**

+		2	<a href="#">3065pb02</a>	<b>Trans-Clear Brick 1 x 2 without Bottom Tube with Completely White Pattern (Sticker)</b> <a href="#">Catalog:</a> <a href="#">Parts:</a> <a href="#">Brick, Decorated</a>	<a href="#">PG</a>
---	---	---	--------------------------	--	--------------------

**Yellow Brick 2 x 8 with 'RALLY VAN' Pattern (Sticker) - Set**



+	 *	2	<a href="#">3007pb03</a>	<b>5550</b> <a href="#">Catalog:</a> <a href="#">Parts:</a> <a href="#">Brick, Decorated</a>	<a href="#">PG</a>
+	 *	2	<a href="#">4181pb014</a>	<b>White Door 1 x 4 x 5 Train Left with Yellow '23' Pattern (Sticker) - Set 5550</b> <a href="#">Catalog:</a> <a href="#">Parts:</a> <a href="#">Door, Decorated</a>	<a href="#">PG</a>
+	 *	1	<a href="#">4182pb013</a>	<b>White Door 1 x 4 x 5 Train Right with Black 'CUSTOM RALLY VAN' Pattern (Sticker) - Set 5550</b> <a href="#">Catalog:</a> <a href="#">Parts:</a> <a href="#">Door, Decorated</a>	<a href="#">PG</a>
+	 *	1	<a href="#">4182pb014</a>	<b>White Door 1 x 4 x 5 Train Right with Yellow '23' Pattern (Sticker) - Set 5550</b> <a href="#">Catalog:</a> <a href="#">Parts:</a> <a href="#">Door, Decorated</a>	<a href="#">PG</a>
+	 *	3	<a href="#">3937c01(inv)</a>	<b>Light Gray Hinge Brick 1 x 2 Base with Same Color Hinge Brick 1 x 2 Top (3937 / 3938)</b> <a href="#">Catalog:</a> <a href="#">Parts:</a> <a href="#">Hinge</a>	<a href="#">PG</a>
+	 *	1	<a href="#">3297pb038</a>	<b>White Slope 33 3 x 4 with Black 'CUSTOM RALLY VAN' Pattern (Sticker) - Set 5550</b> <a href="#">Catalog:</a> <a href="#">Parts:</a> <a href="#">Slope, Decorated</a>	<a href="#">PG</a>
+	 *	2	<a href="#">BA61pb01</a>	<b>White Stickered Assembly 8 x 1 x 1 2/3 with Black 'CUSTOM' Pattern (Sticker) - Set 5550 - 1 Brick 1 x 8, 2 Plates 1 x 8</b> <a href="#">Catalog:</a> <a href="#">Parts:</a> <a href="#">Sticker Over Assembly</a>	<a href="#">PG</a>

**Summary:**

Type	Unique Lots	Total Qty
<b>Regular Items:</b>		
Parts	148	511
<b>Extra Items:</b>		
Parts	5	5
<b>Counterparts:</b>		
Parts	8	14

**Source:**  
Instructions

[Francois. \(313\)](#)  inventoried this Set on Nov 16, 2006, inventory last updated on Jan 7, 2019.