

**MODEL TEAM**

**5540**

**LEGO**

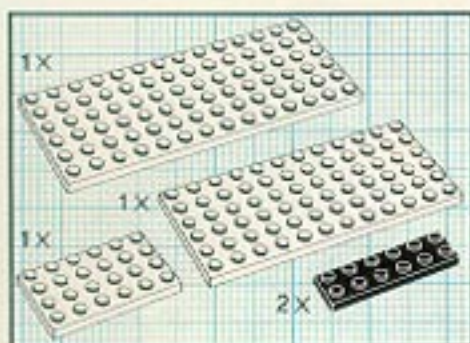

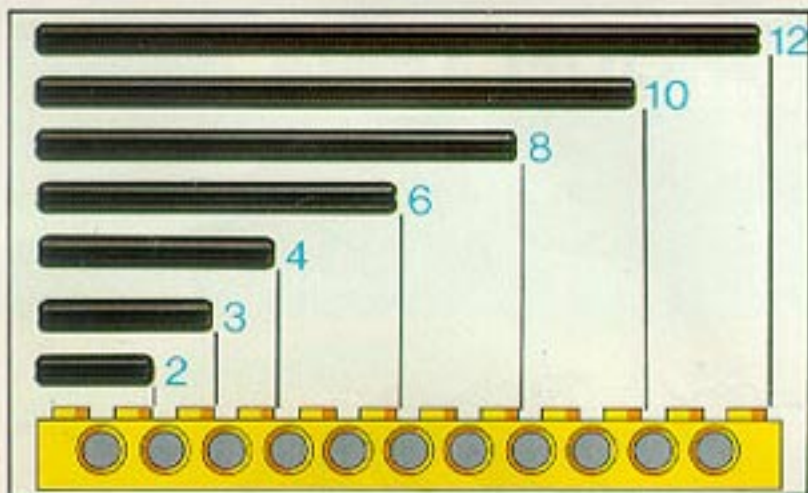

1

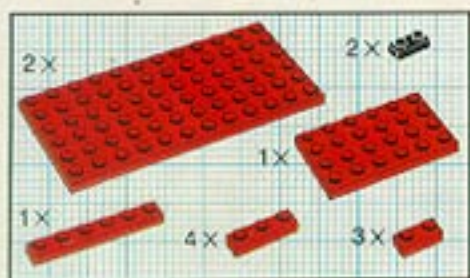
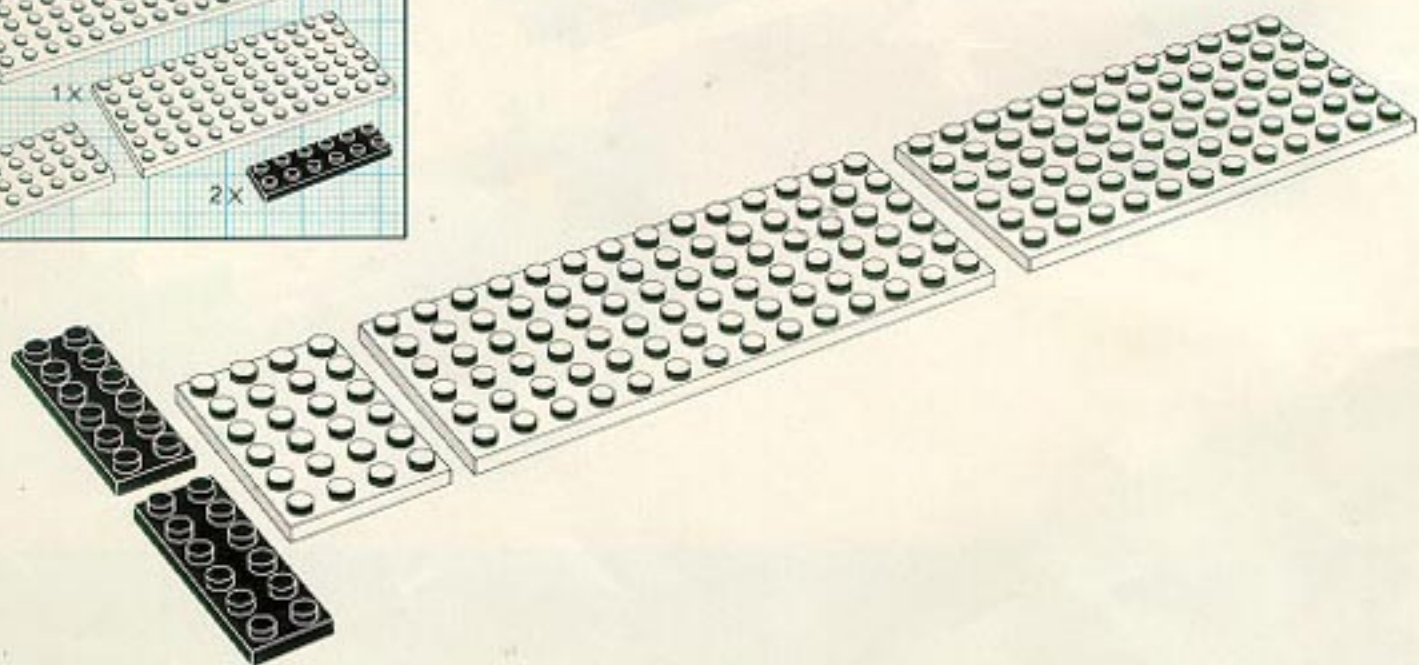

2

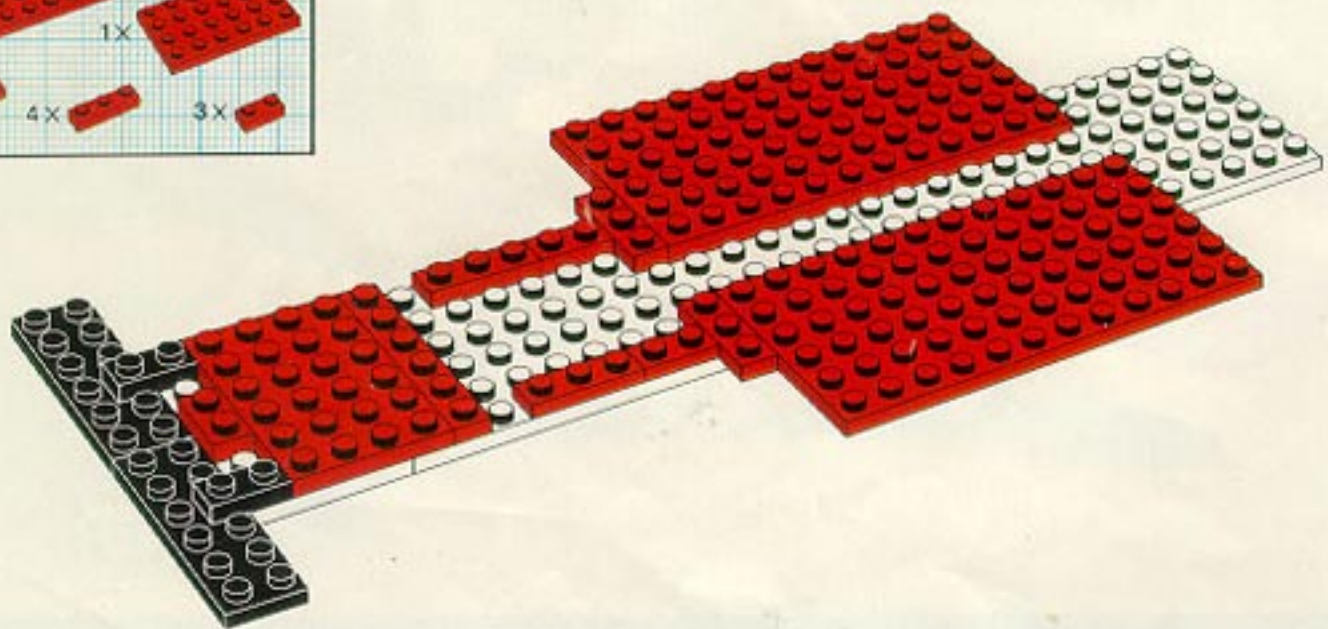

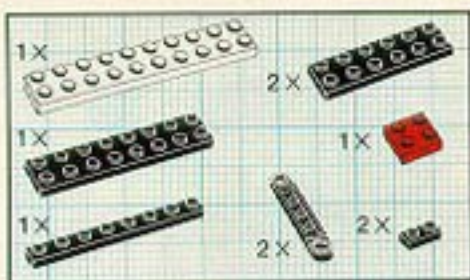

### 3

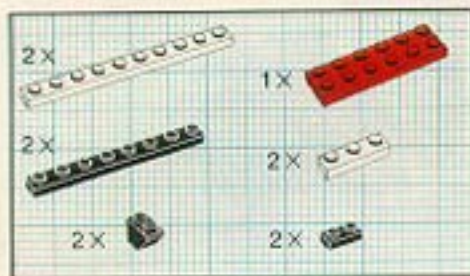
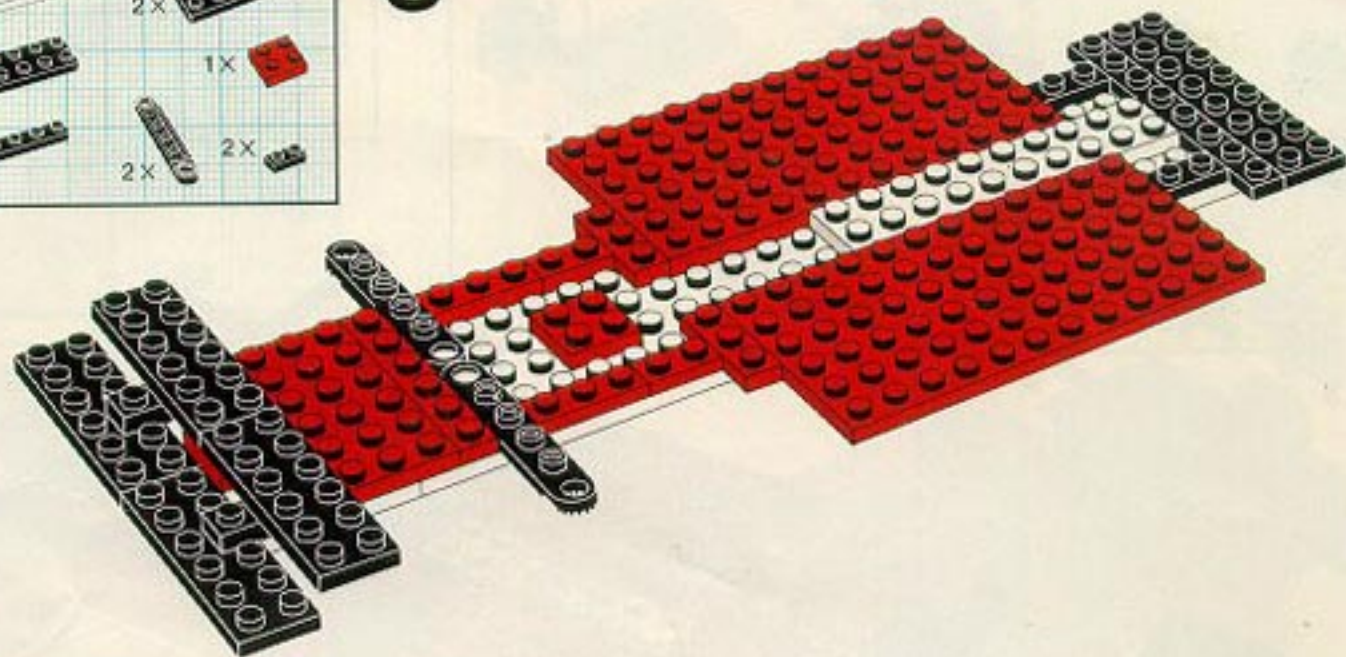

### 4

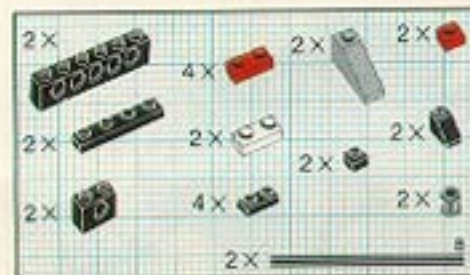
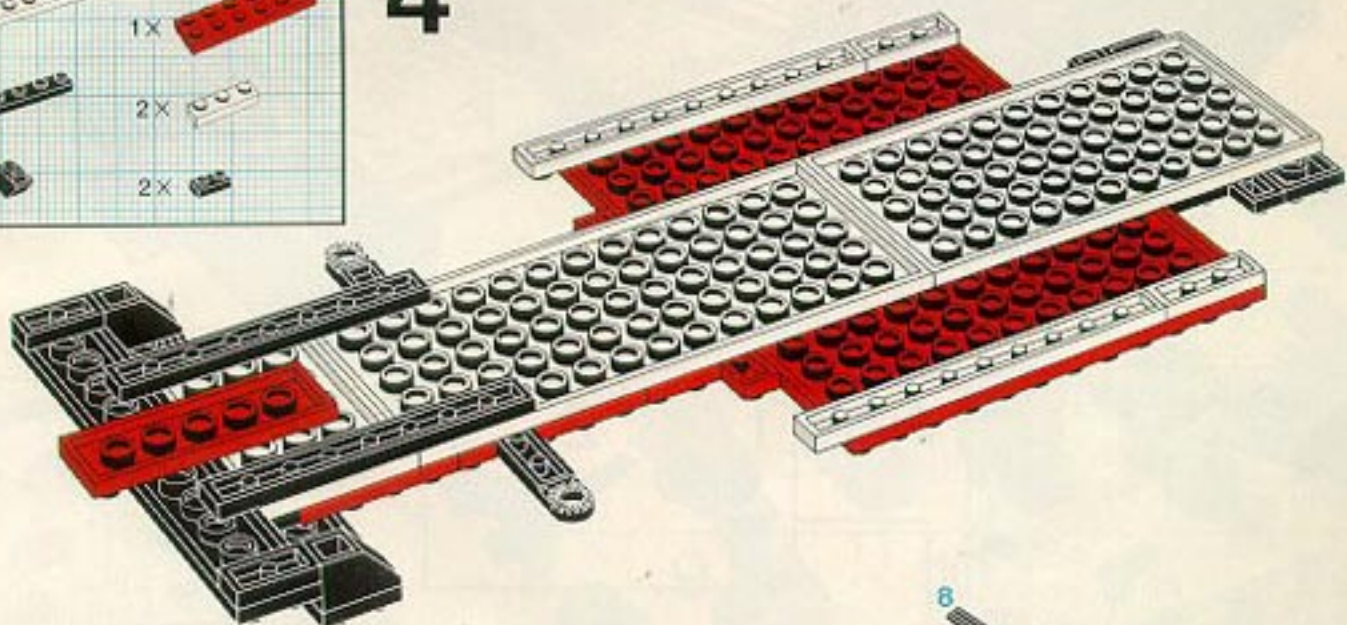

### 5

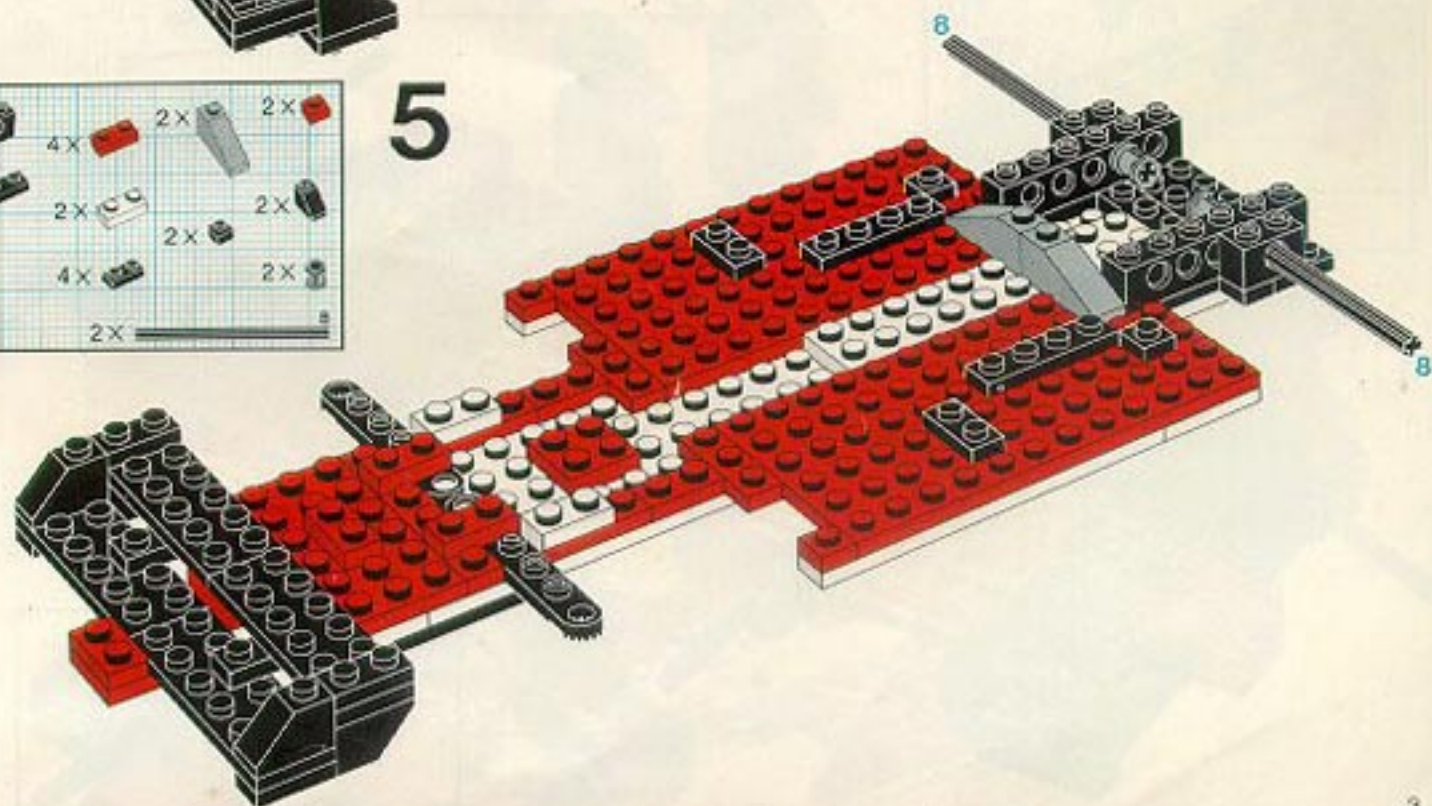

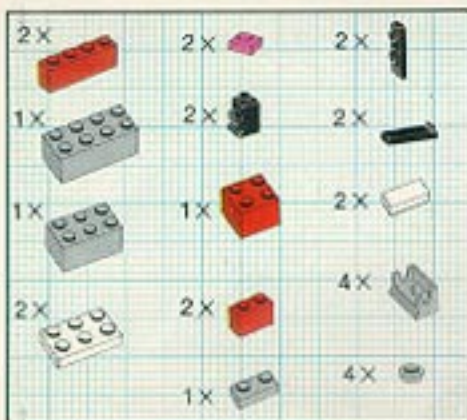

# 6

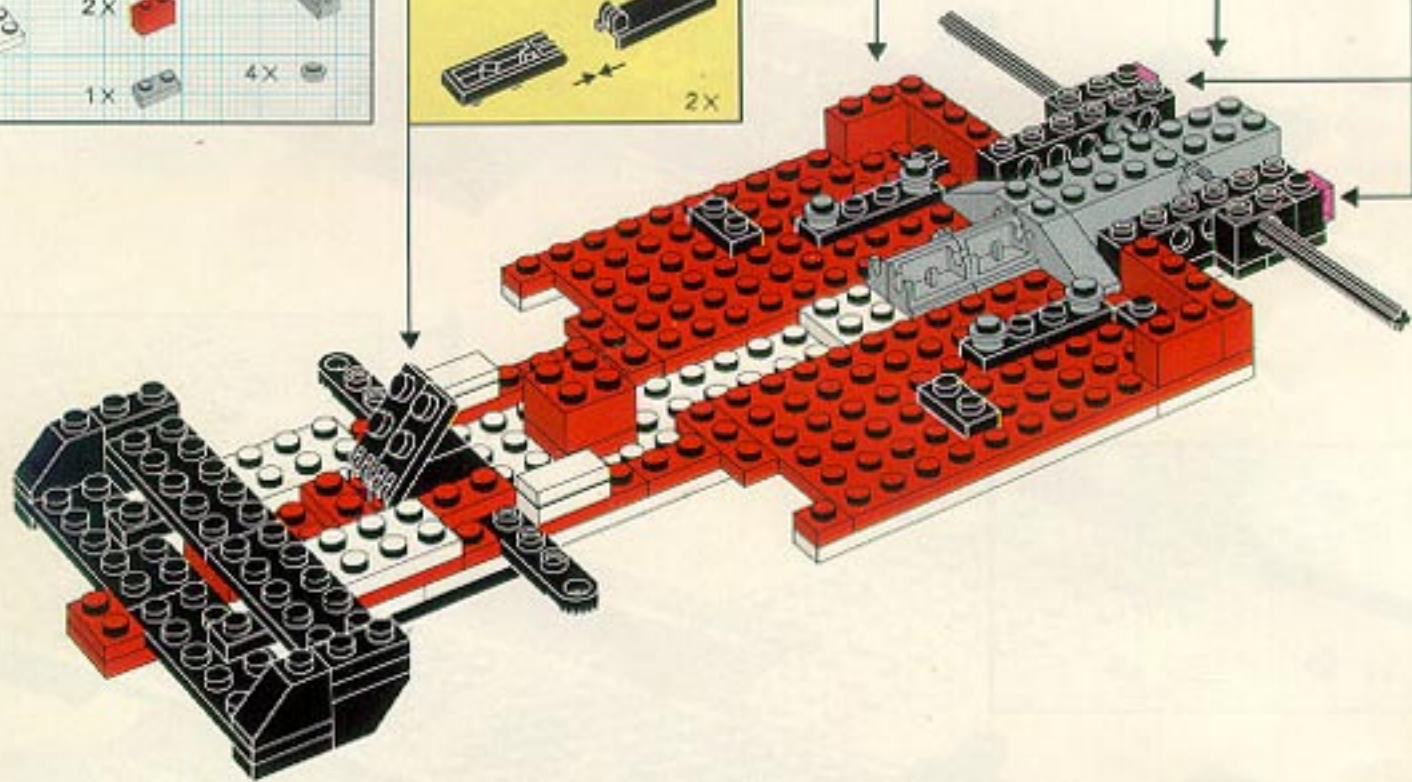
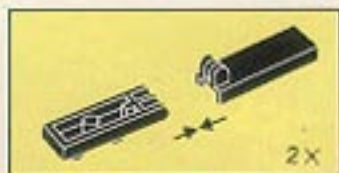
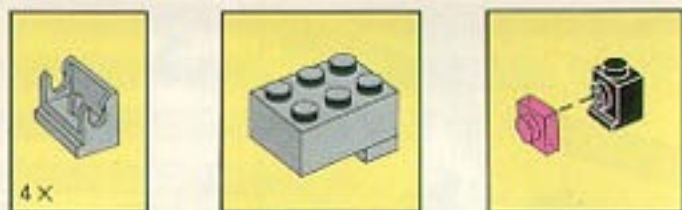

# 7

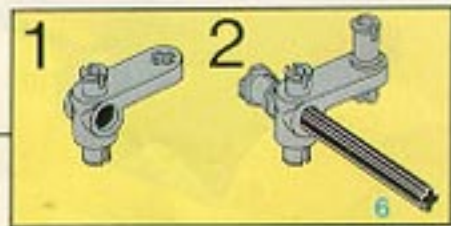
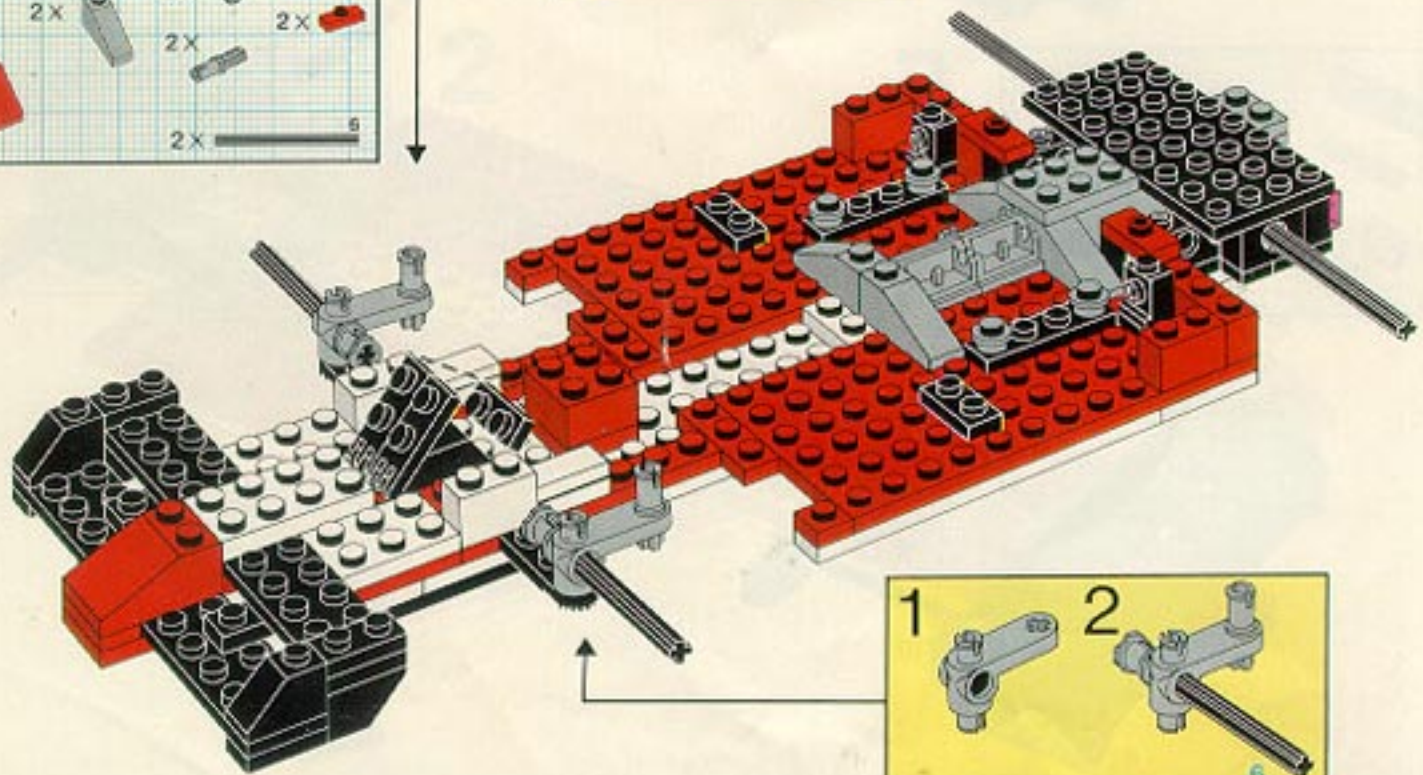
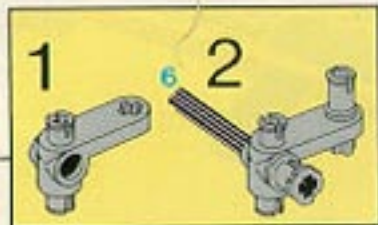

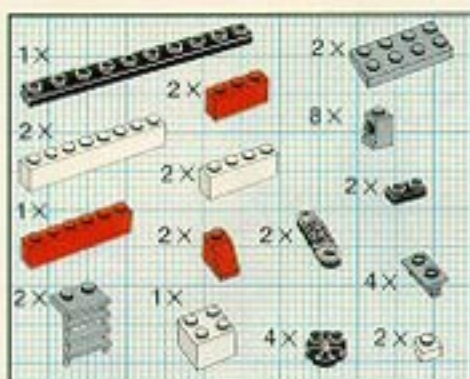

8

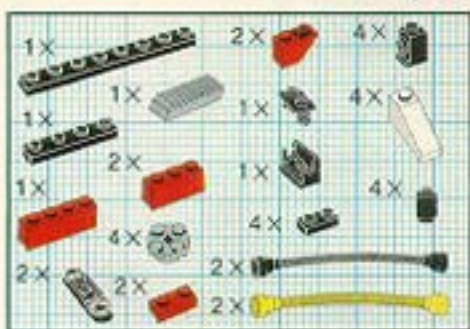
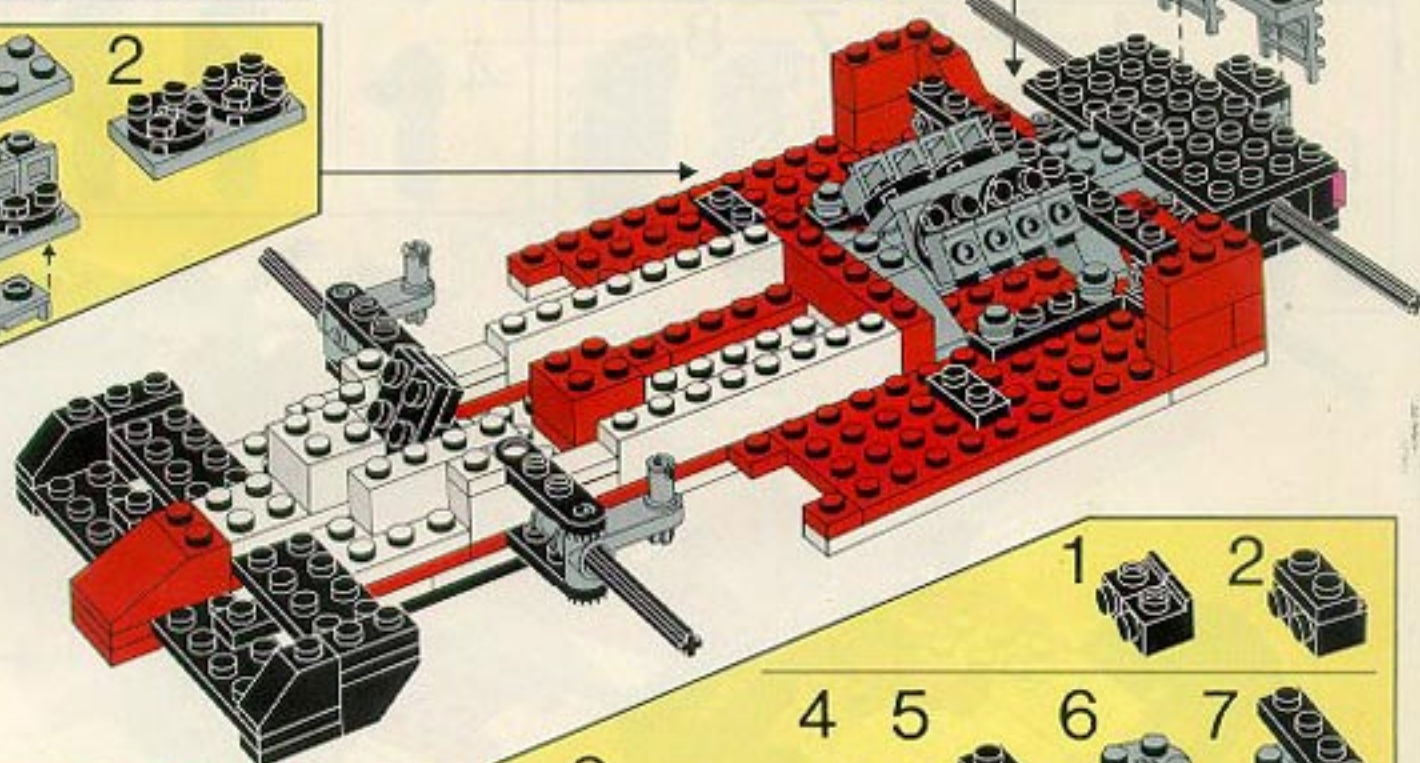
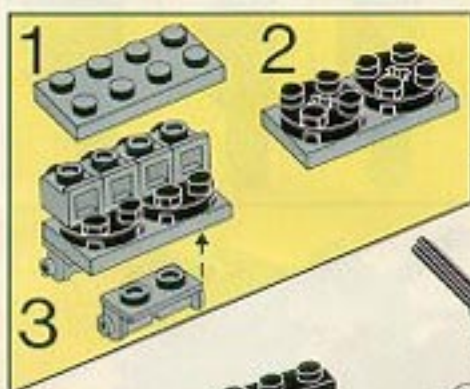
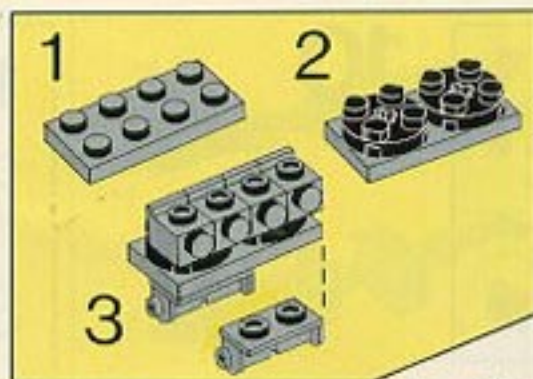

9

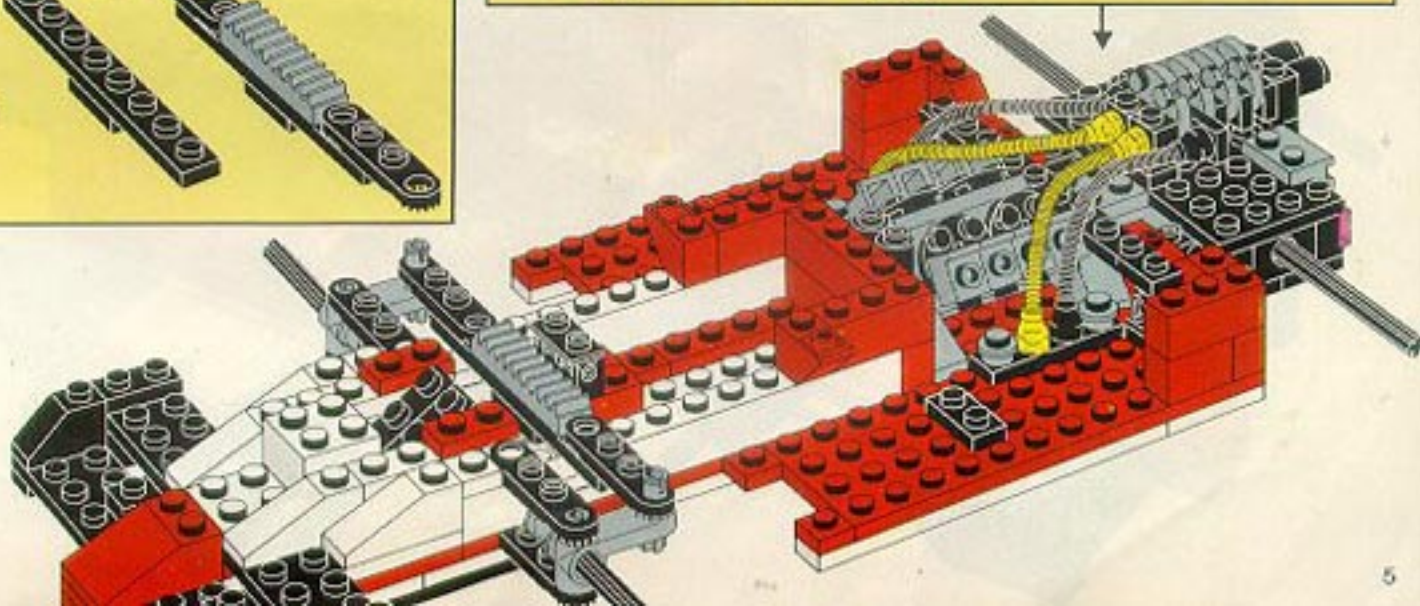
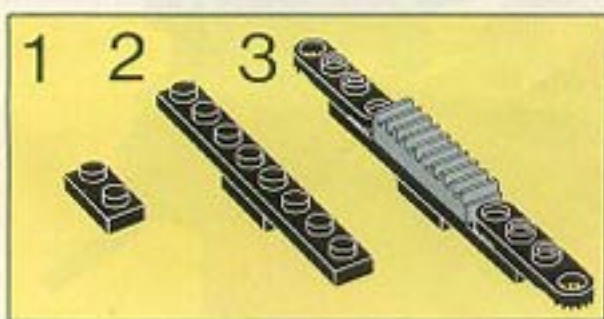
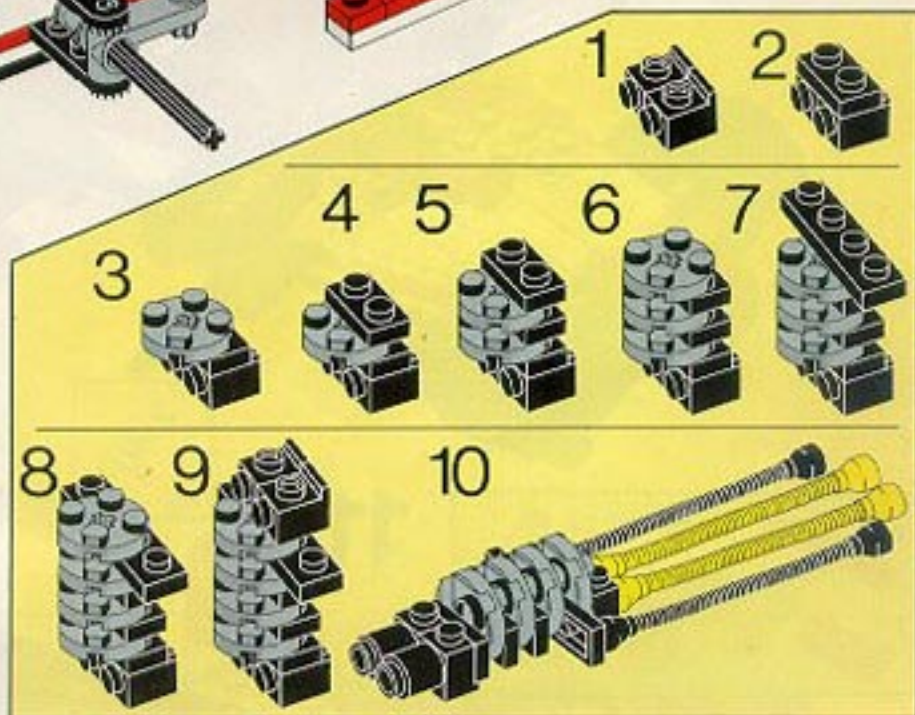

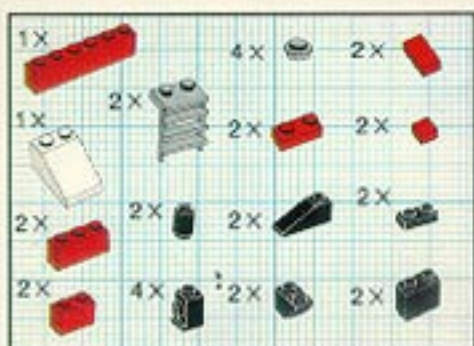

# 10

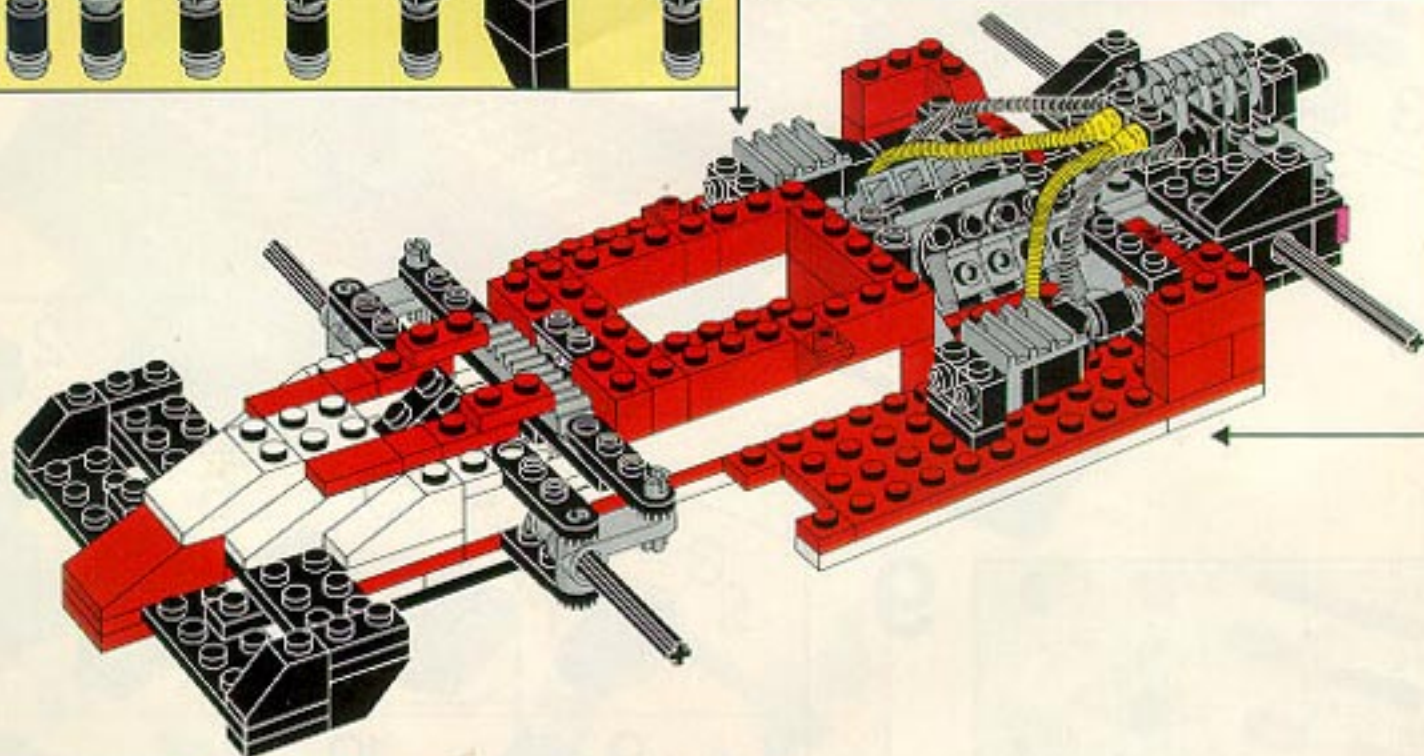
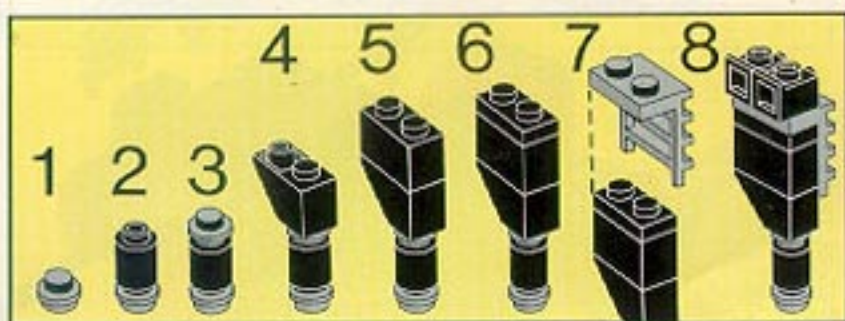
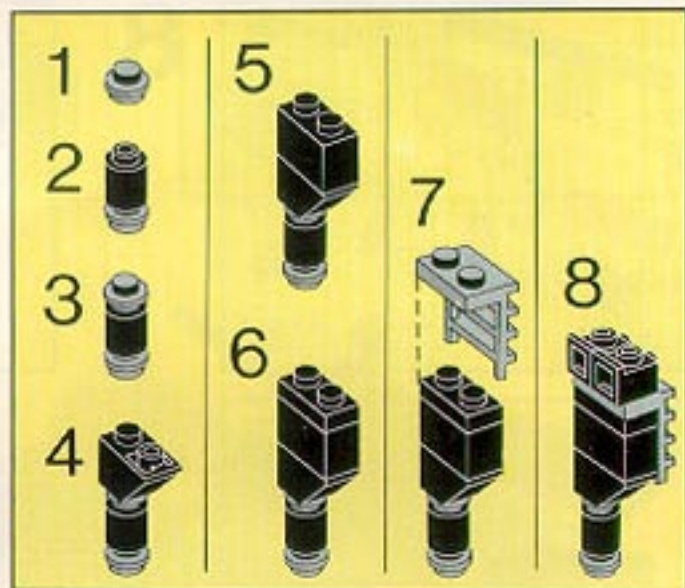

# 11

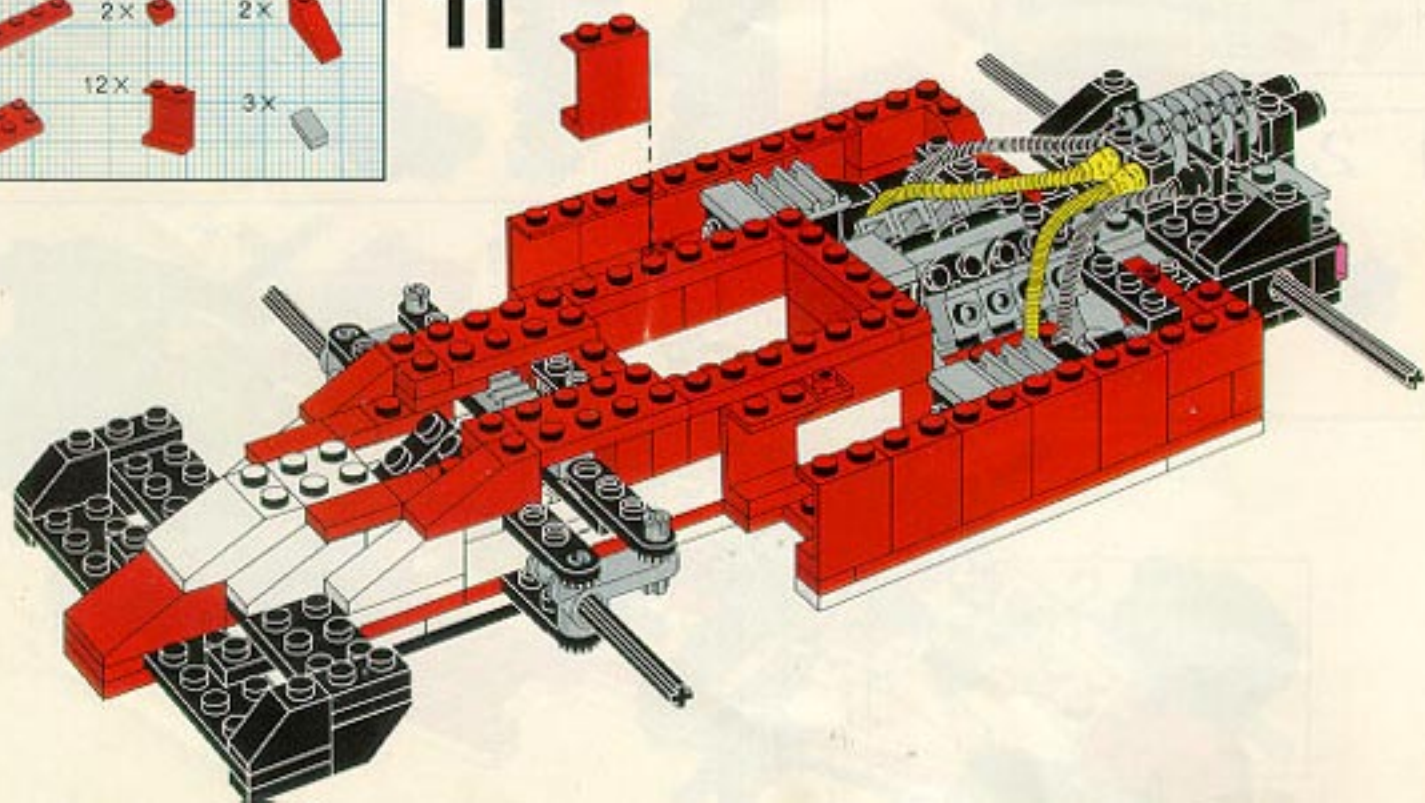

# 12

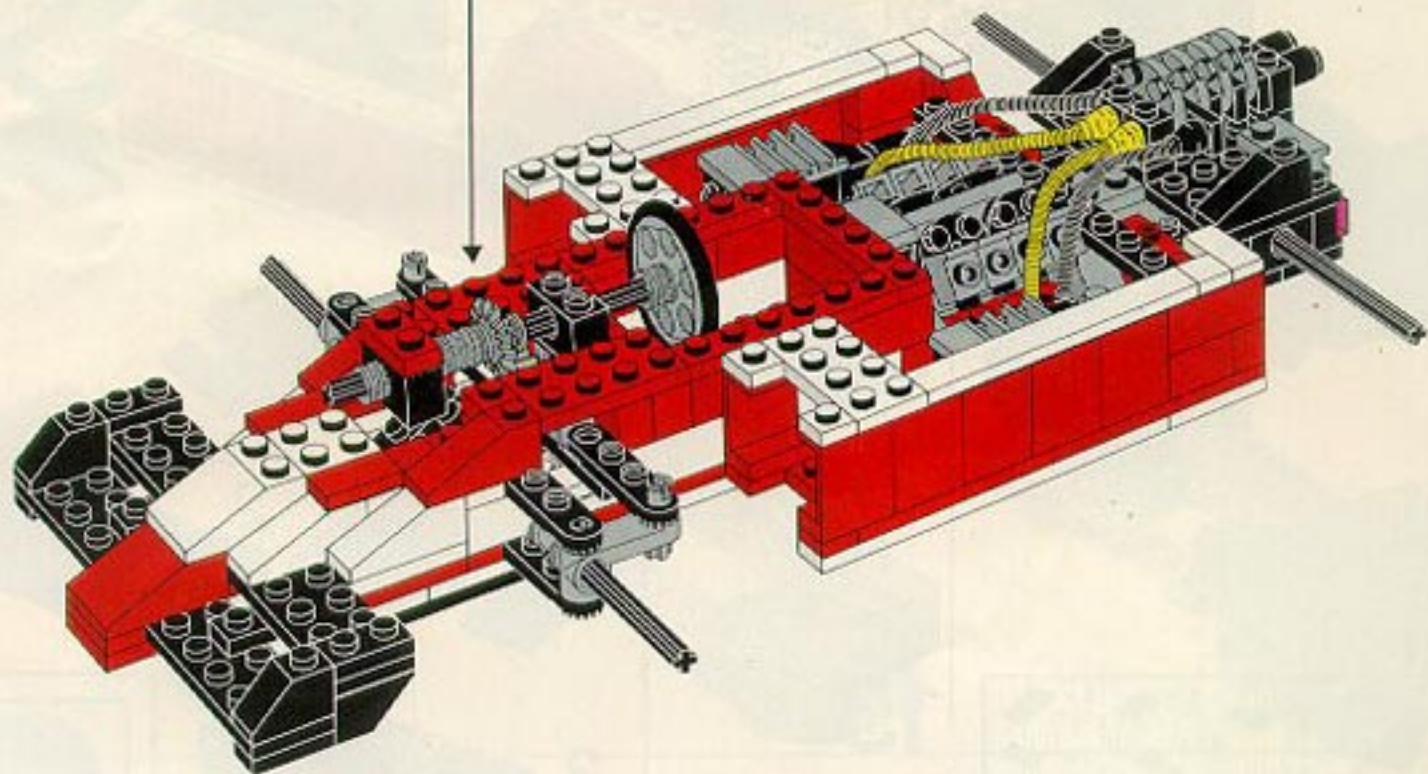
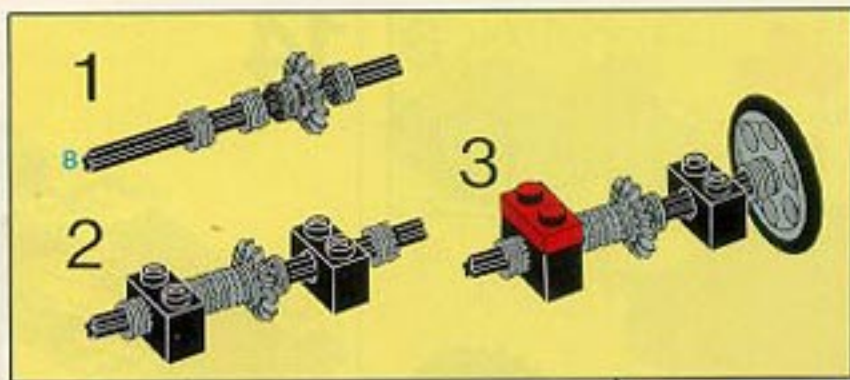
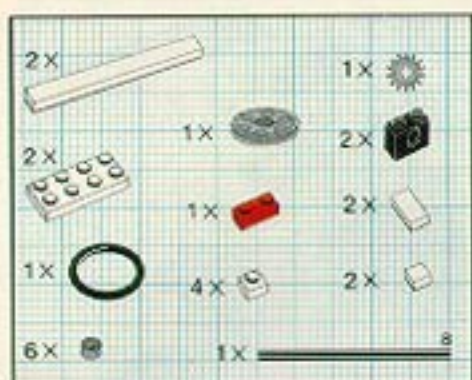

# 13

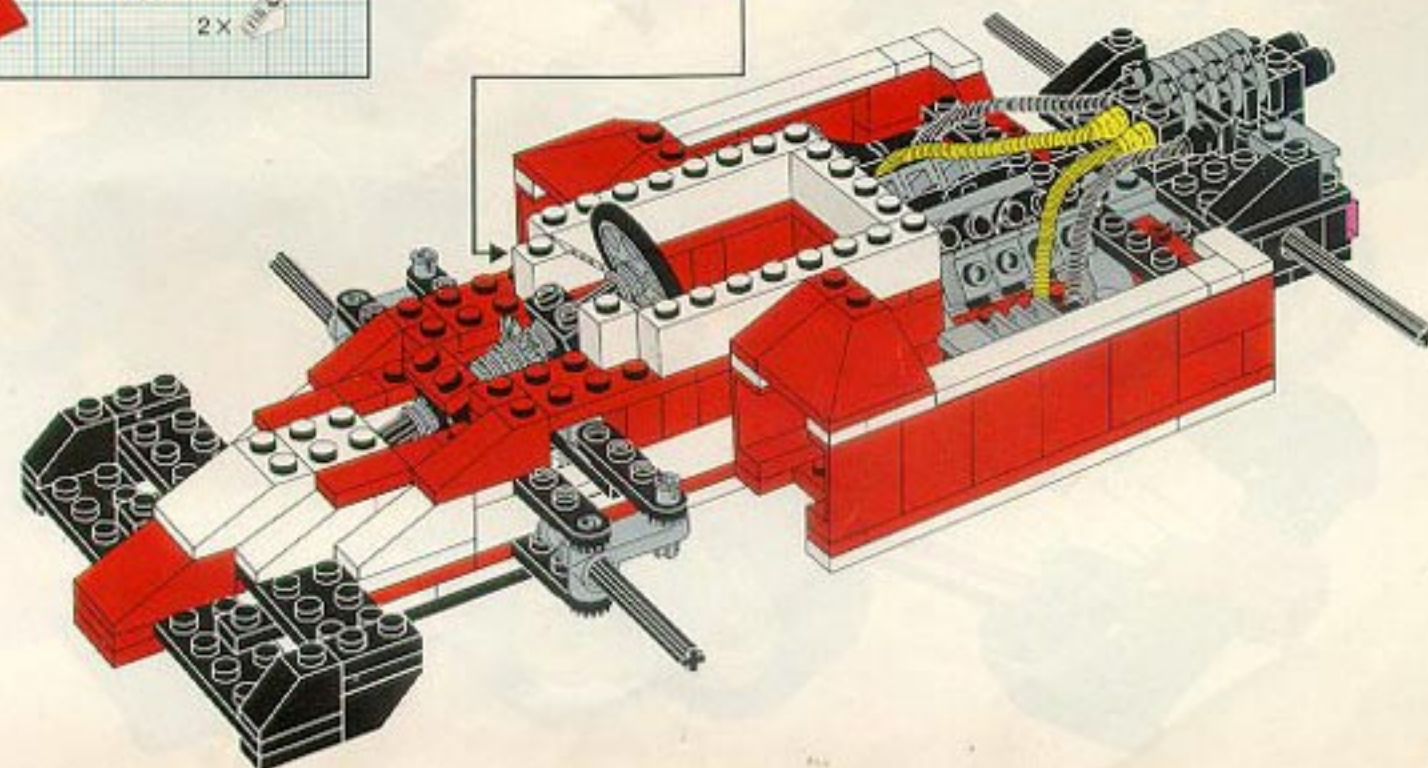
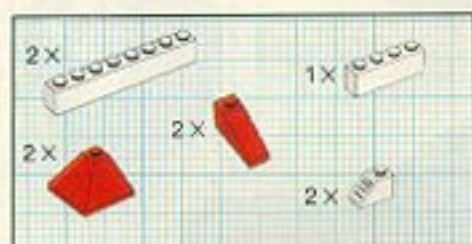



# 14

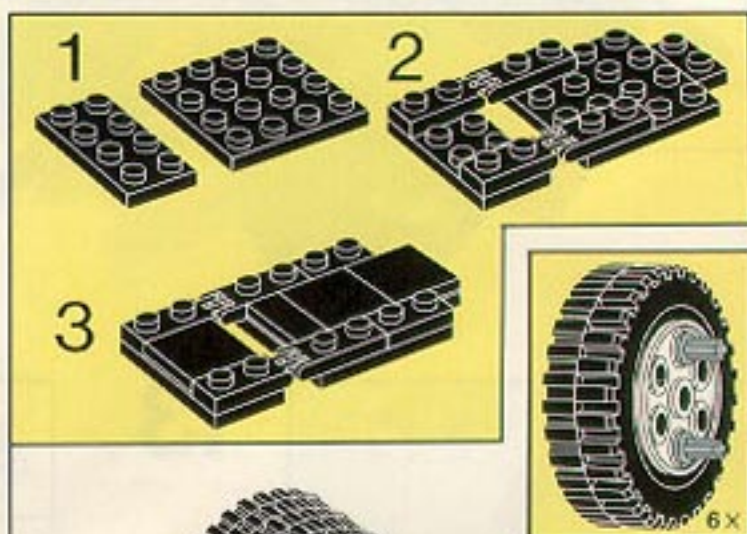
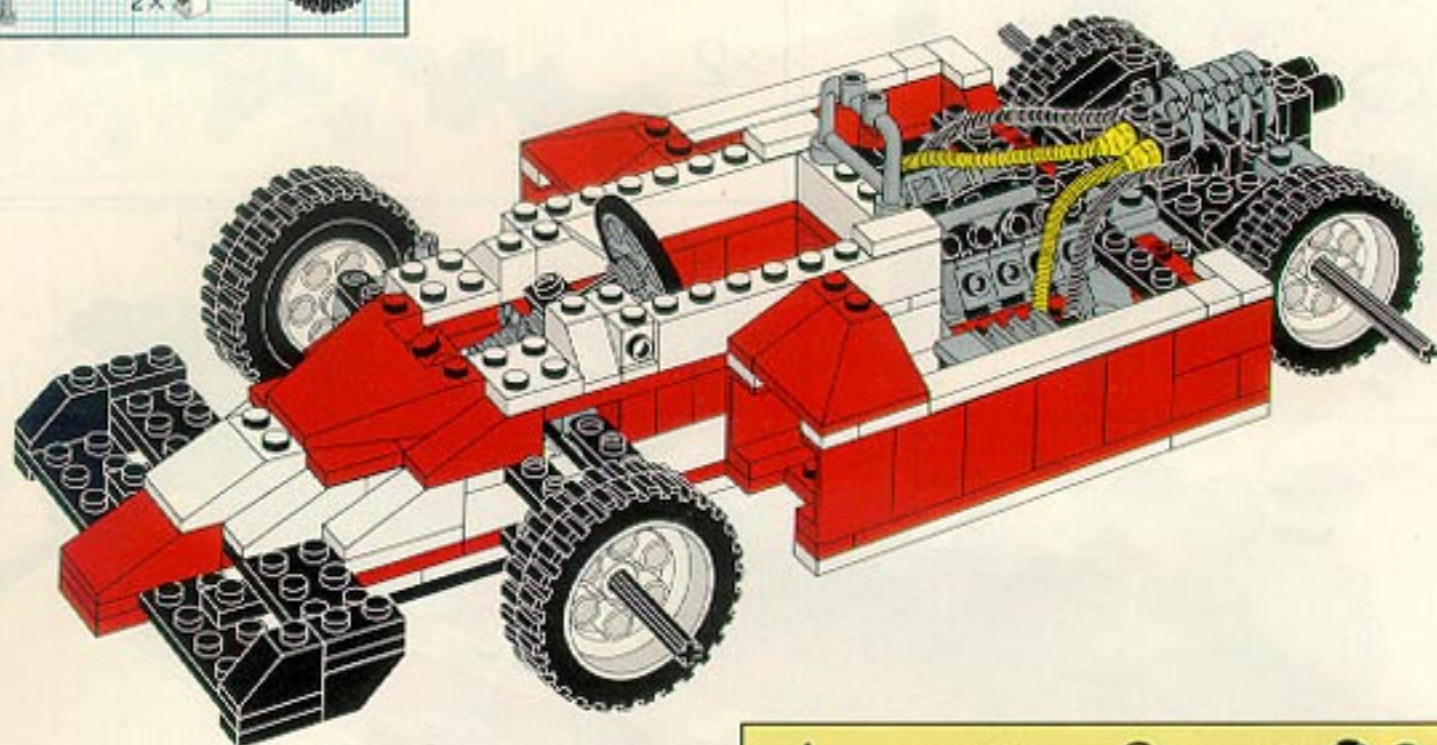

# 15

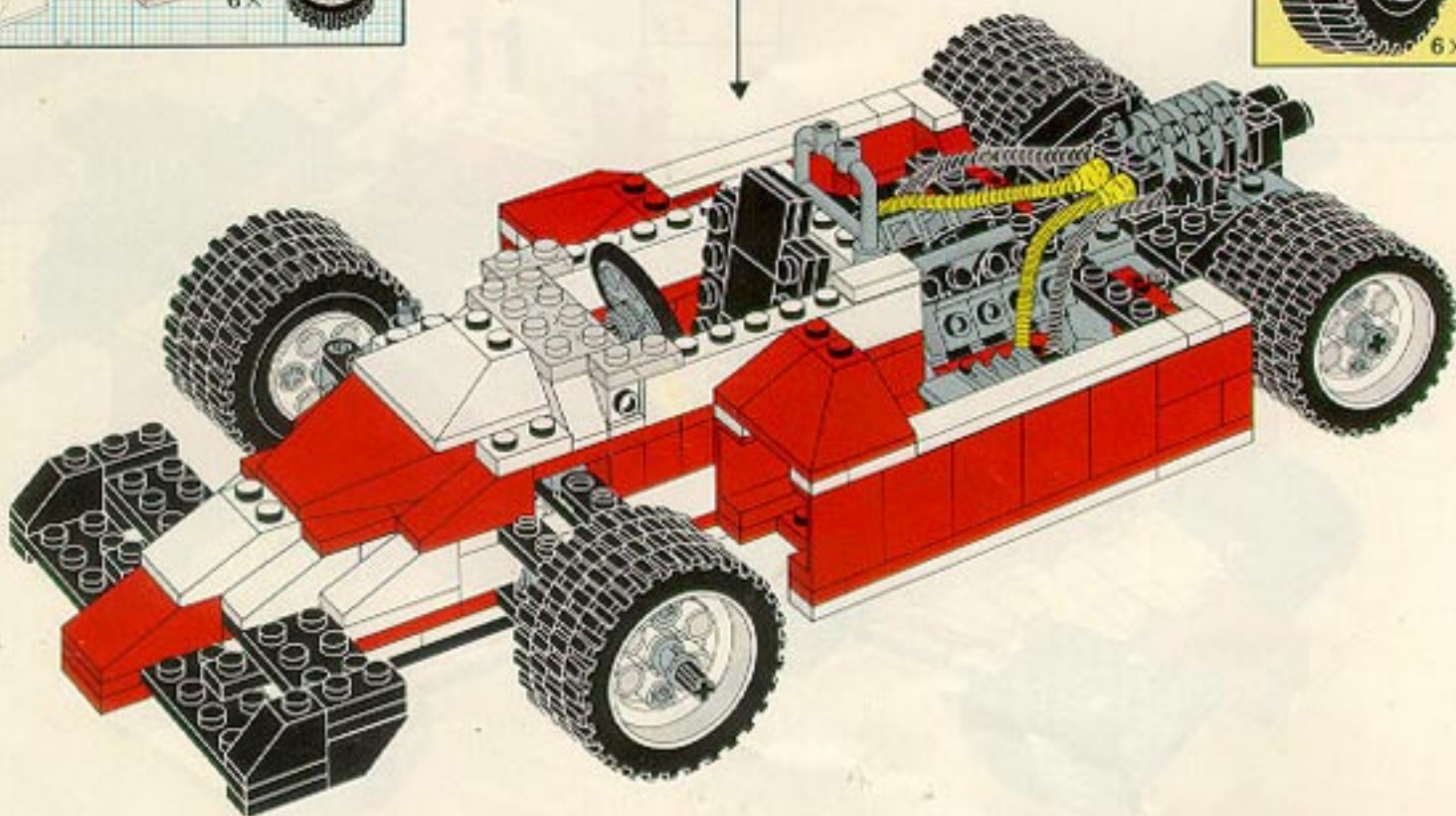





# 16

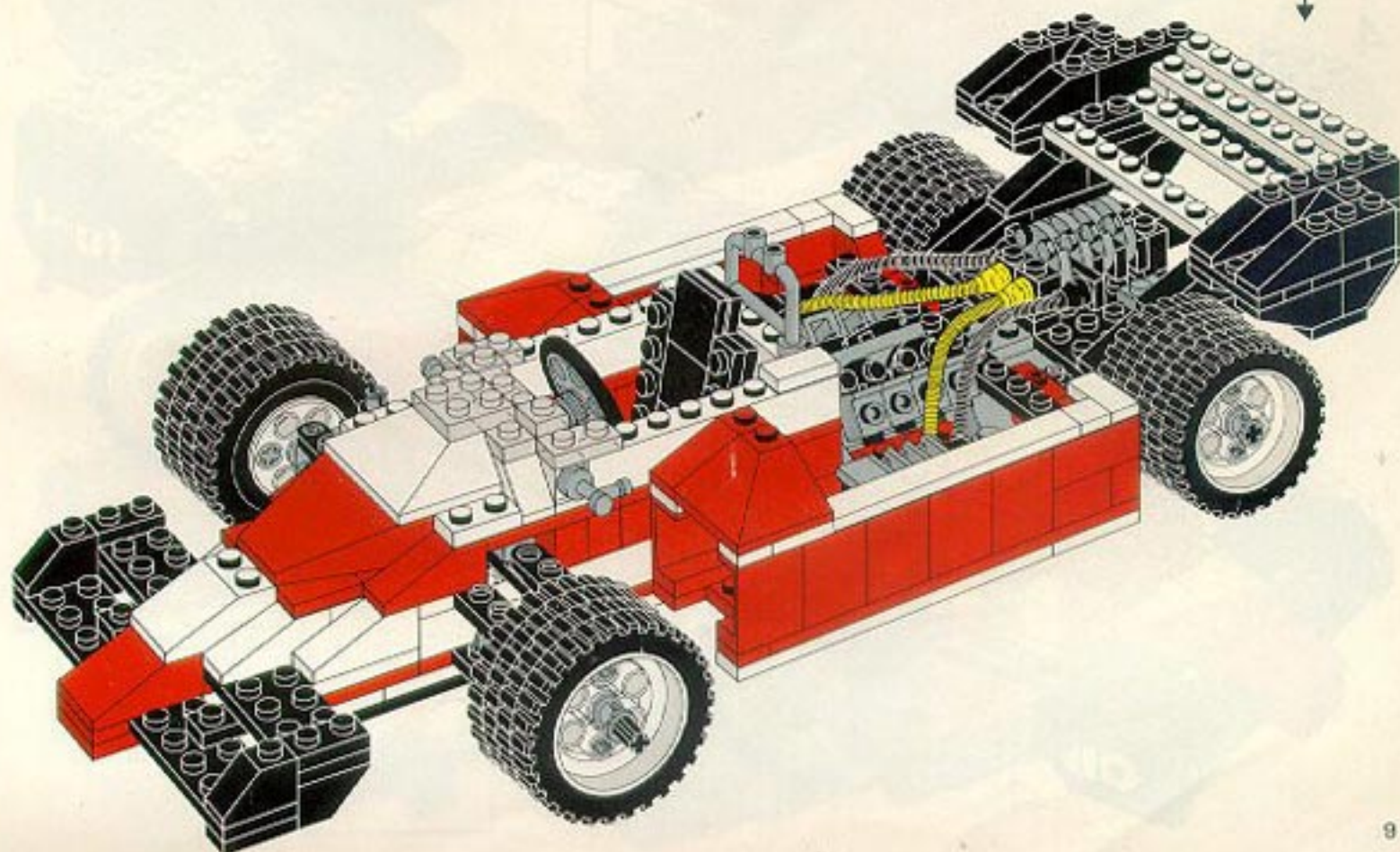
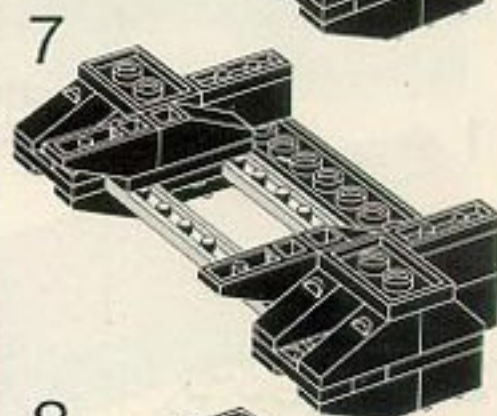
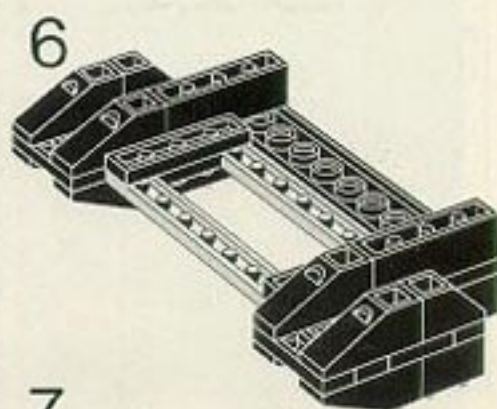
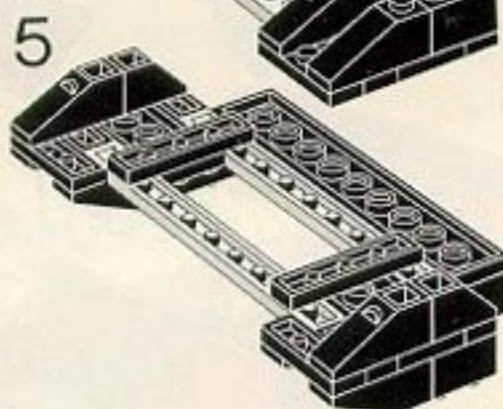
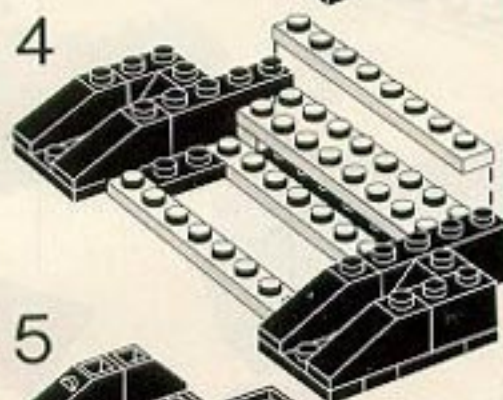
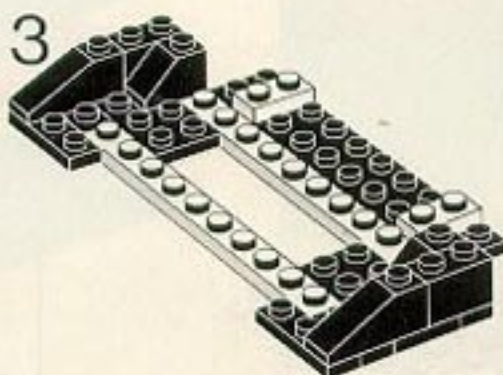
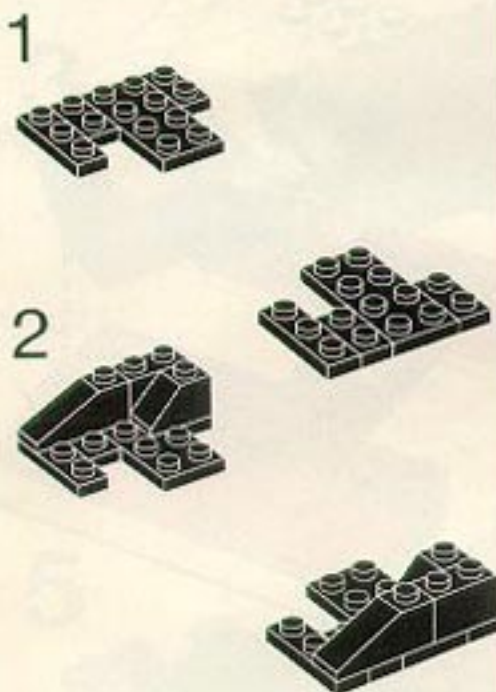

# 17

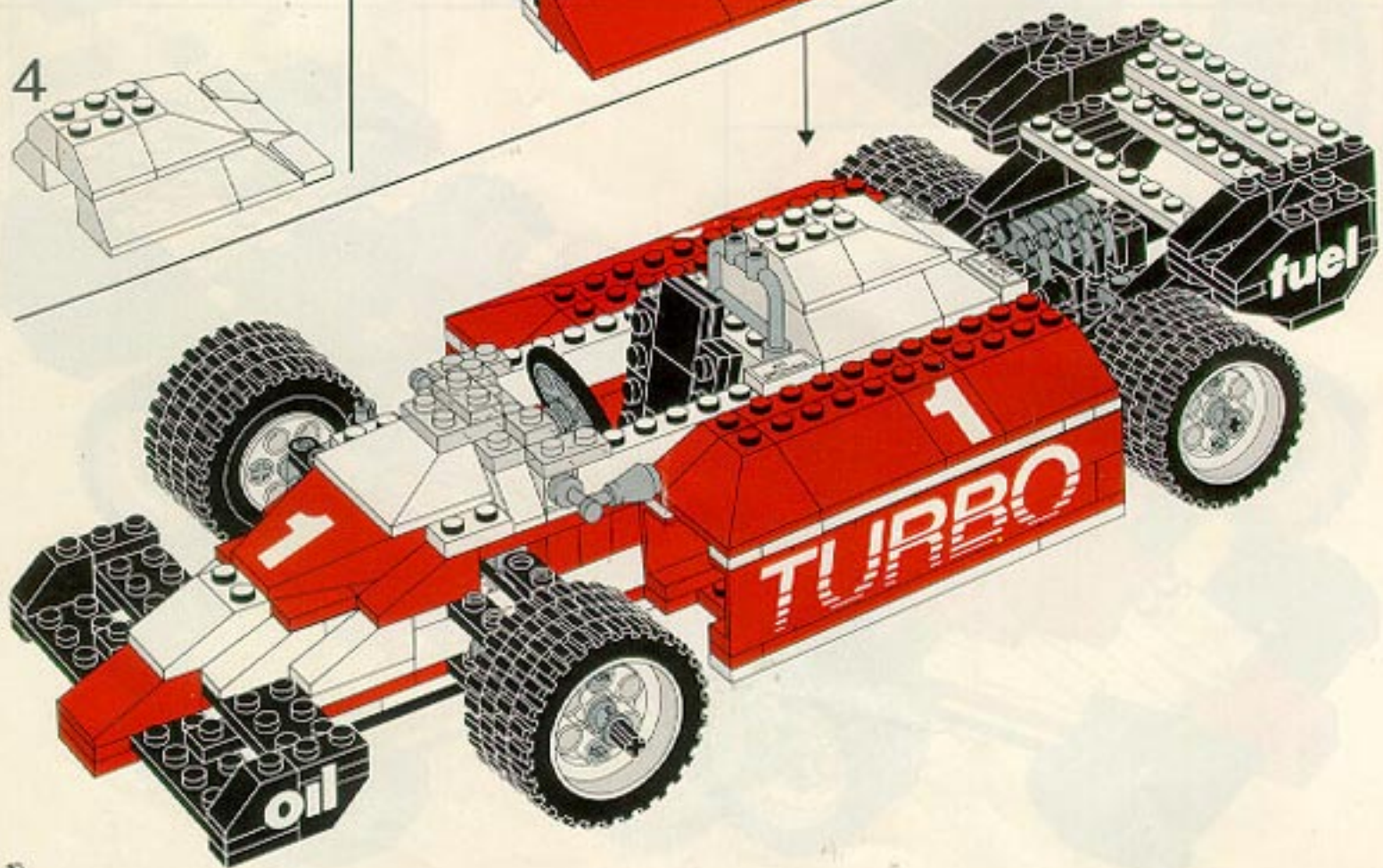
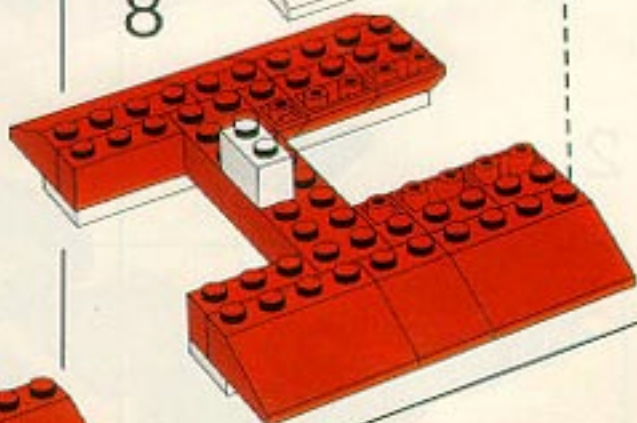
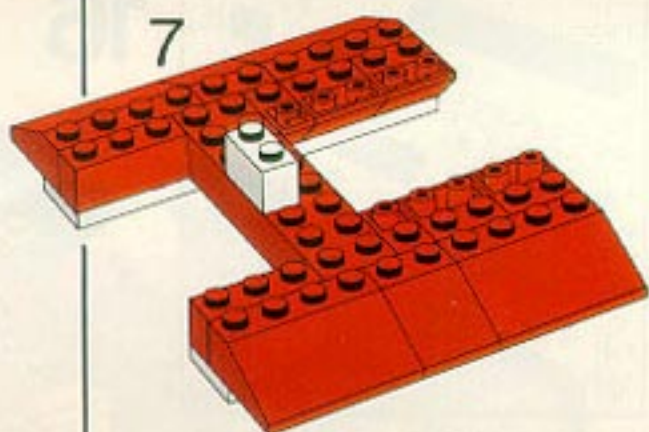
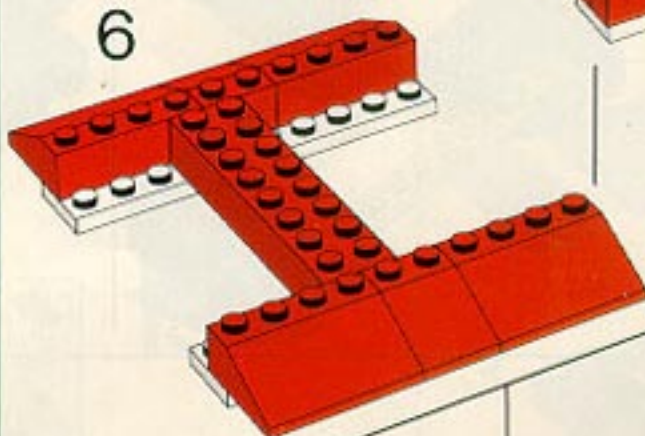
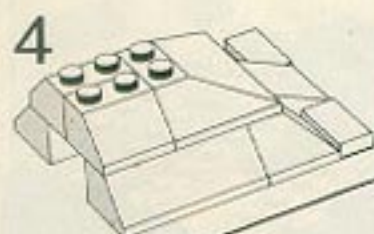
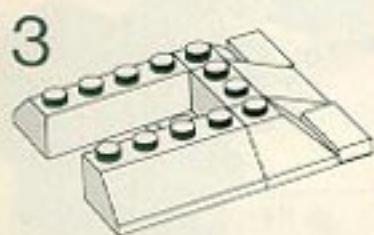
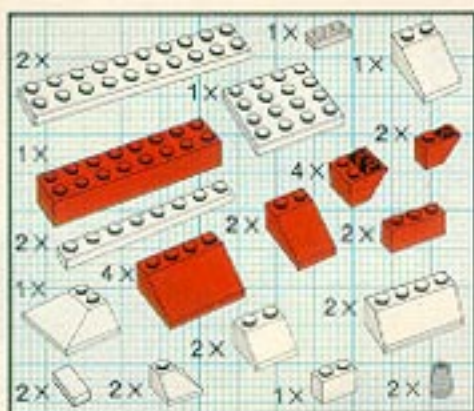

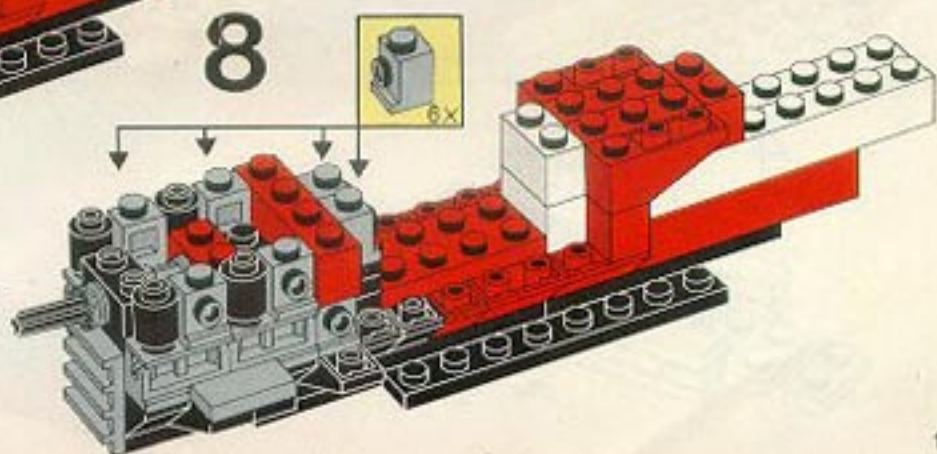
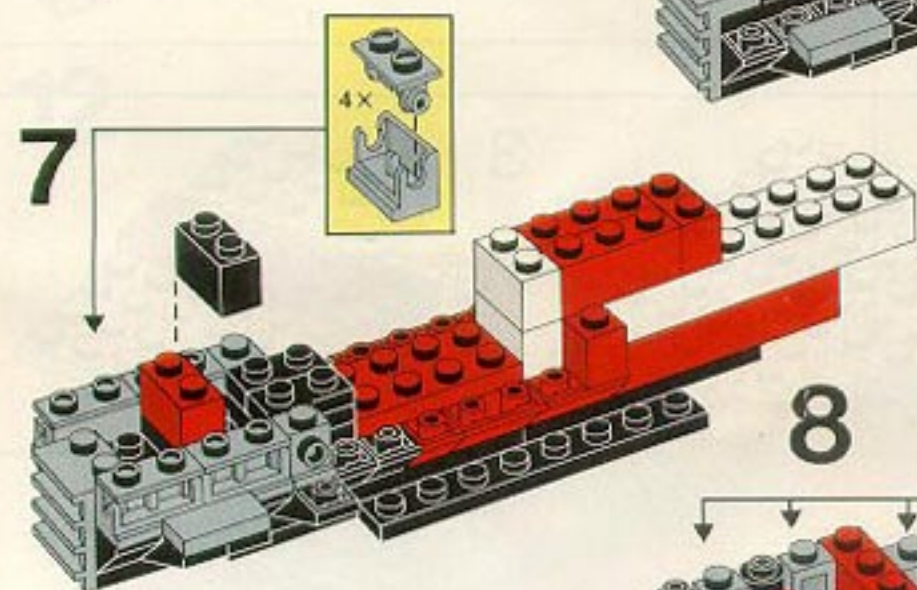
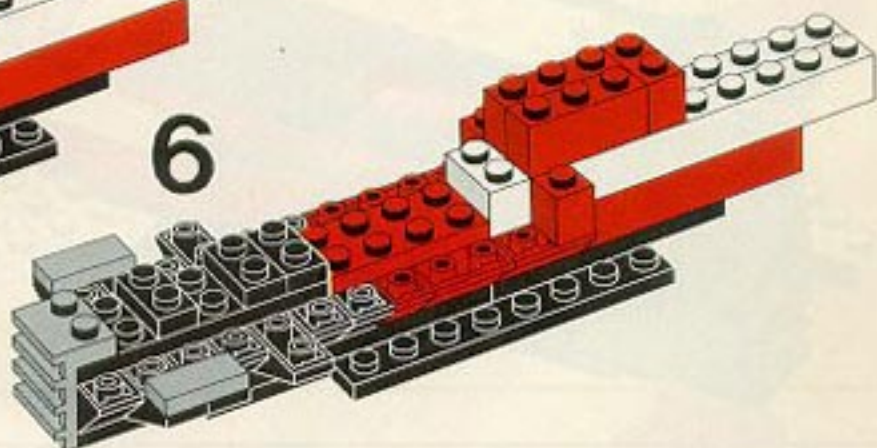
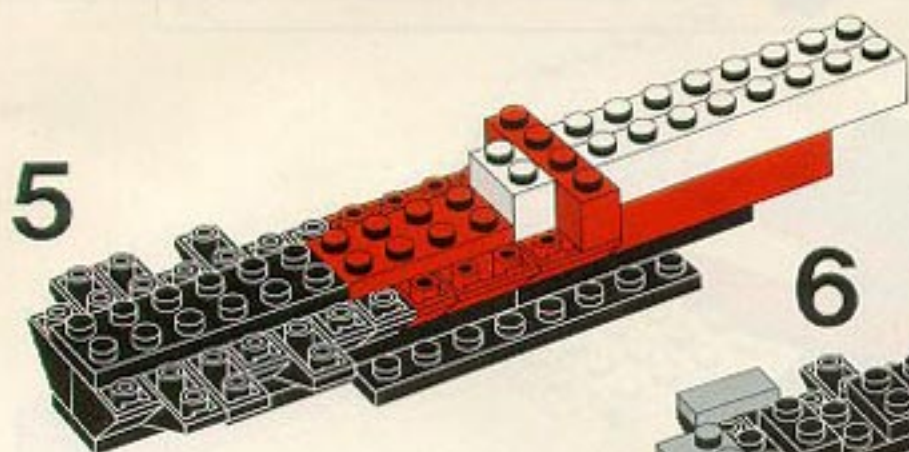
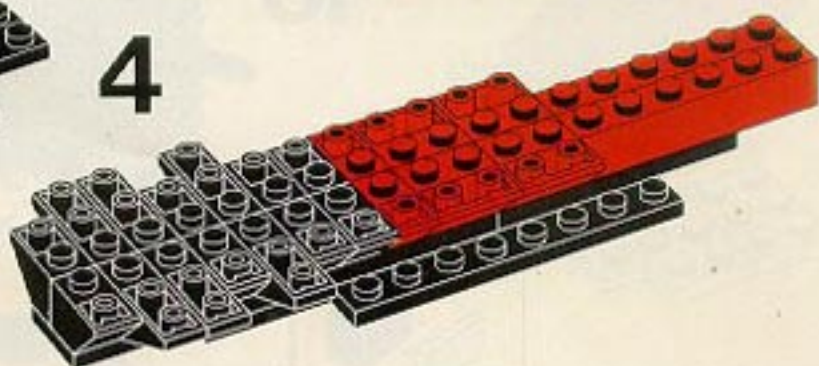

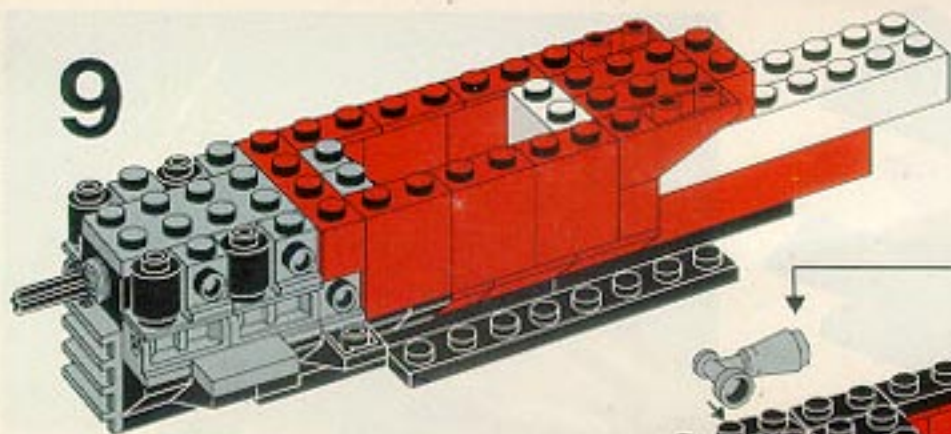

10

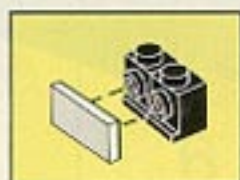
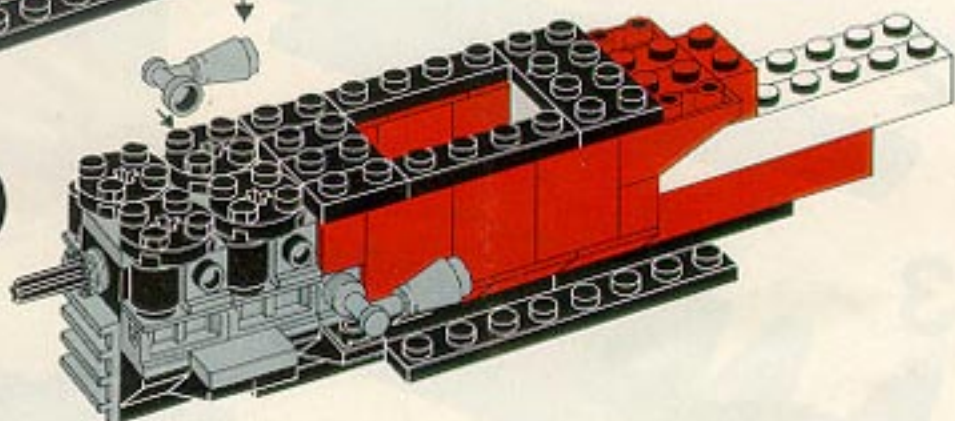

11

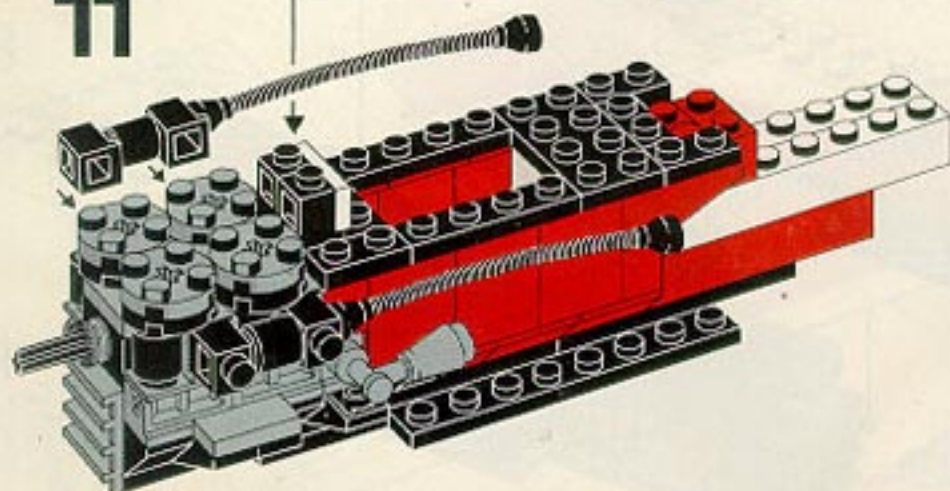

1



2

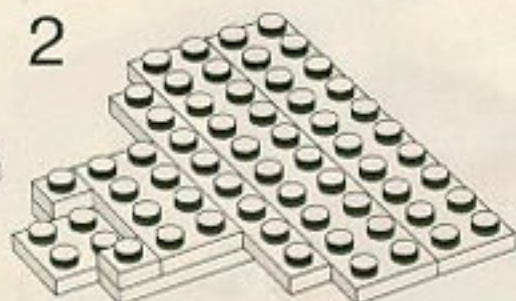

3

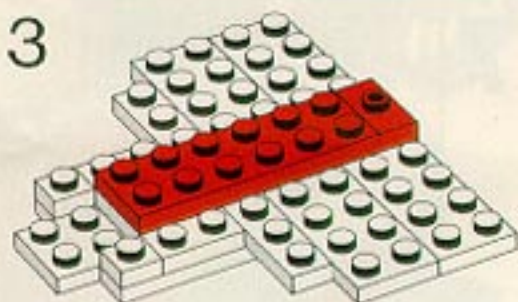

4

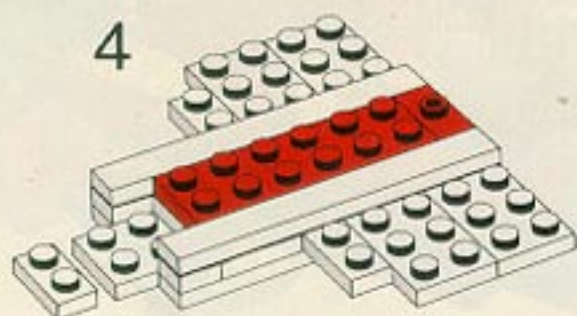

5

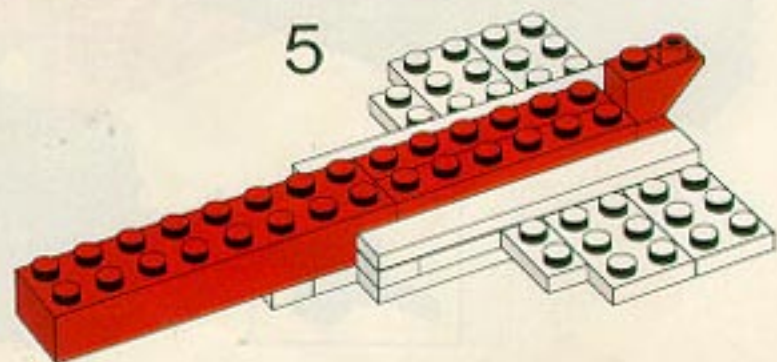

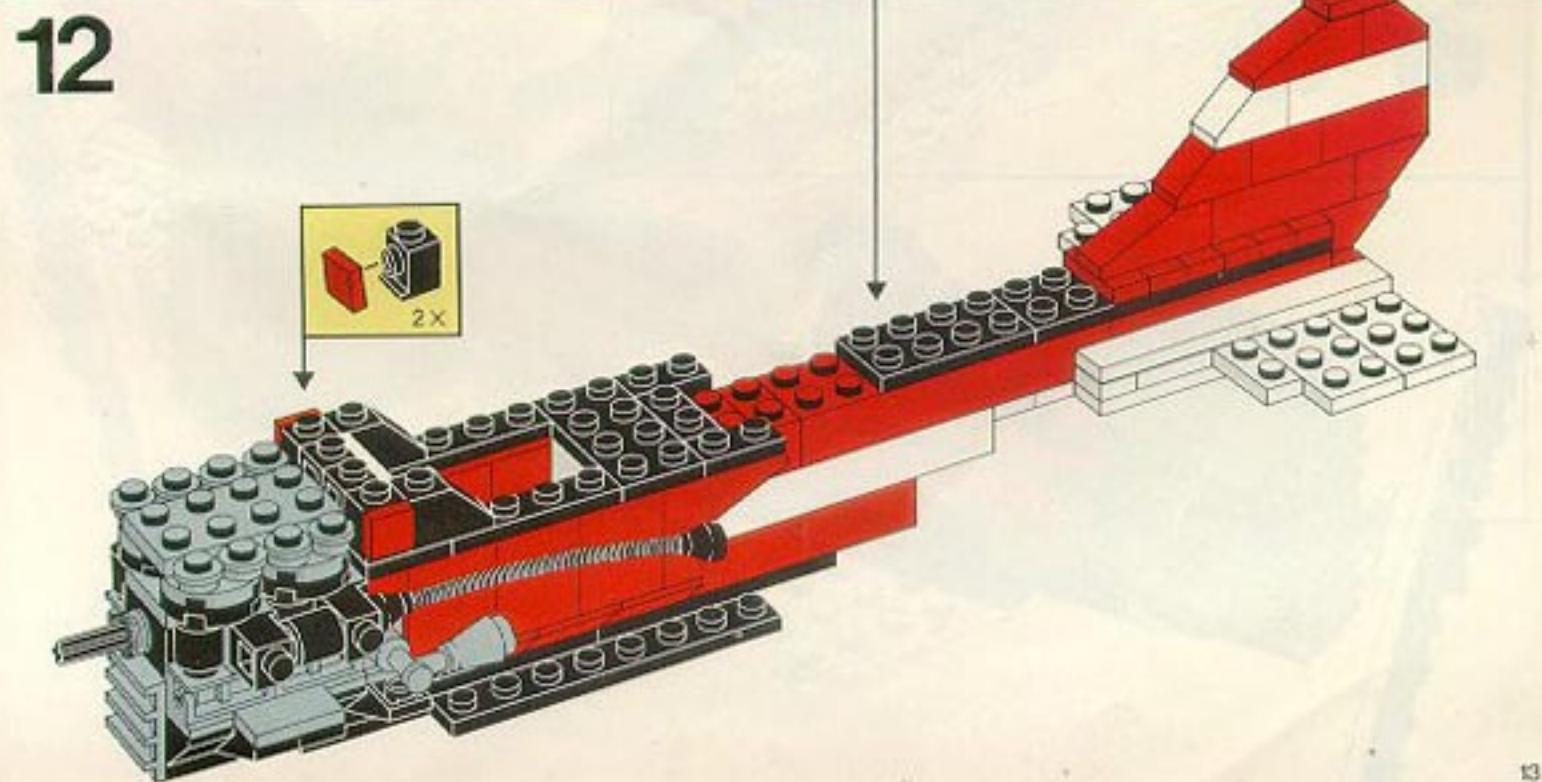
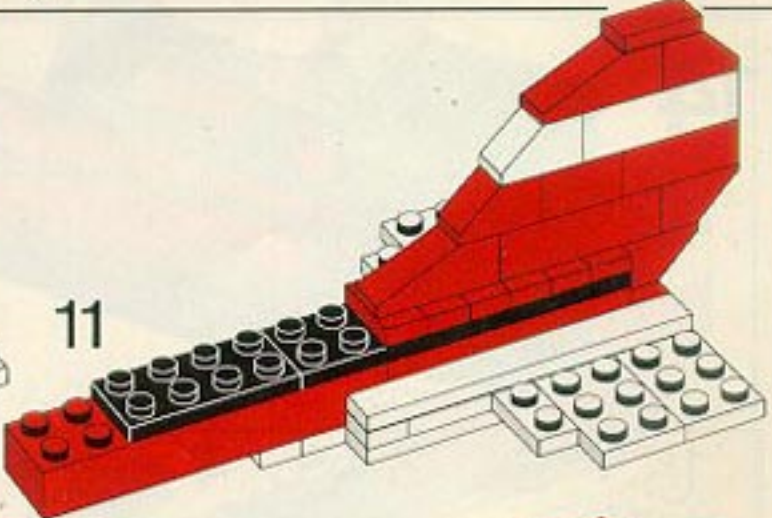
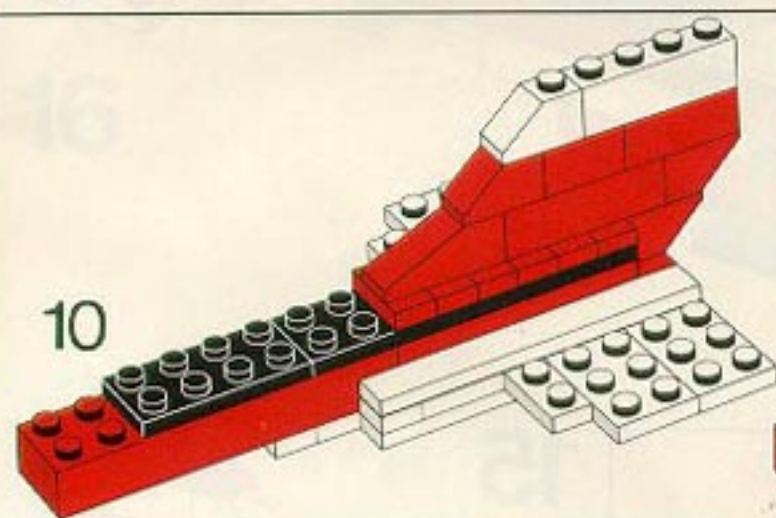
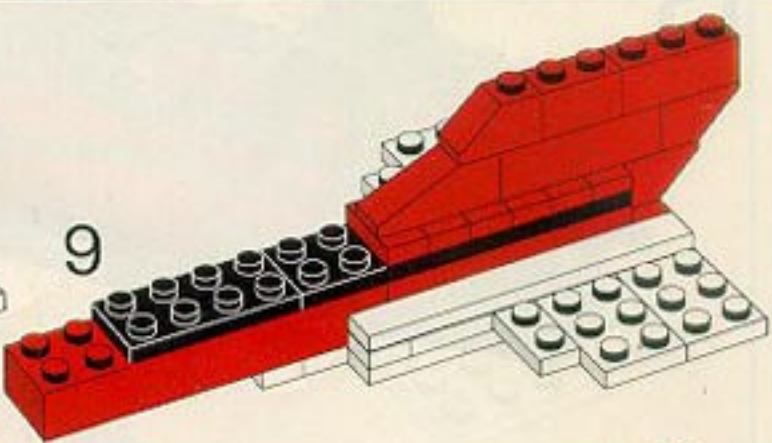
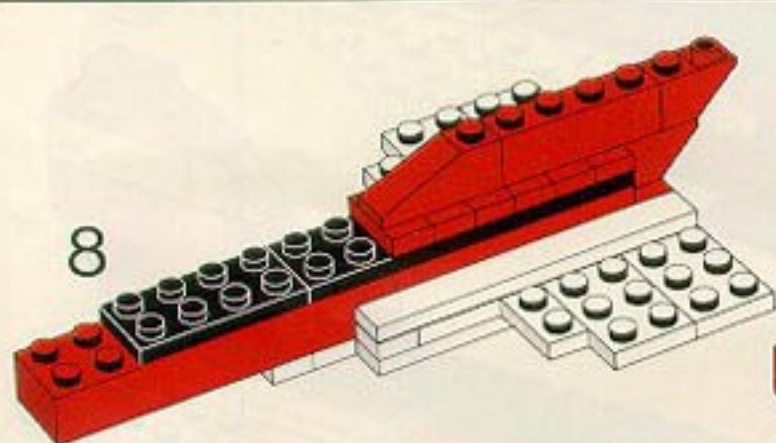
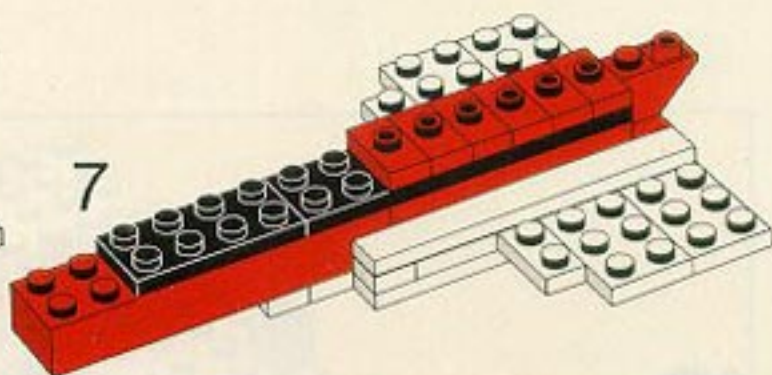
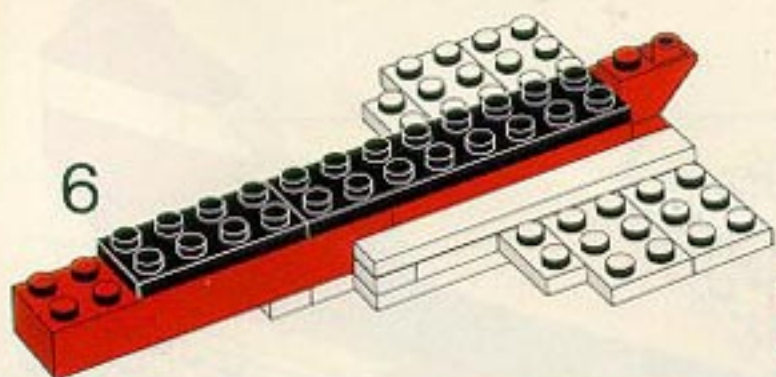

13

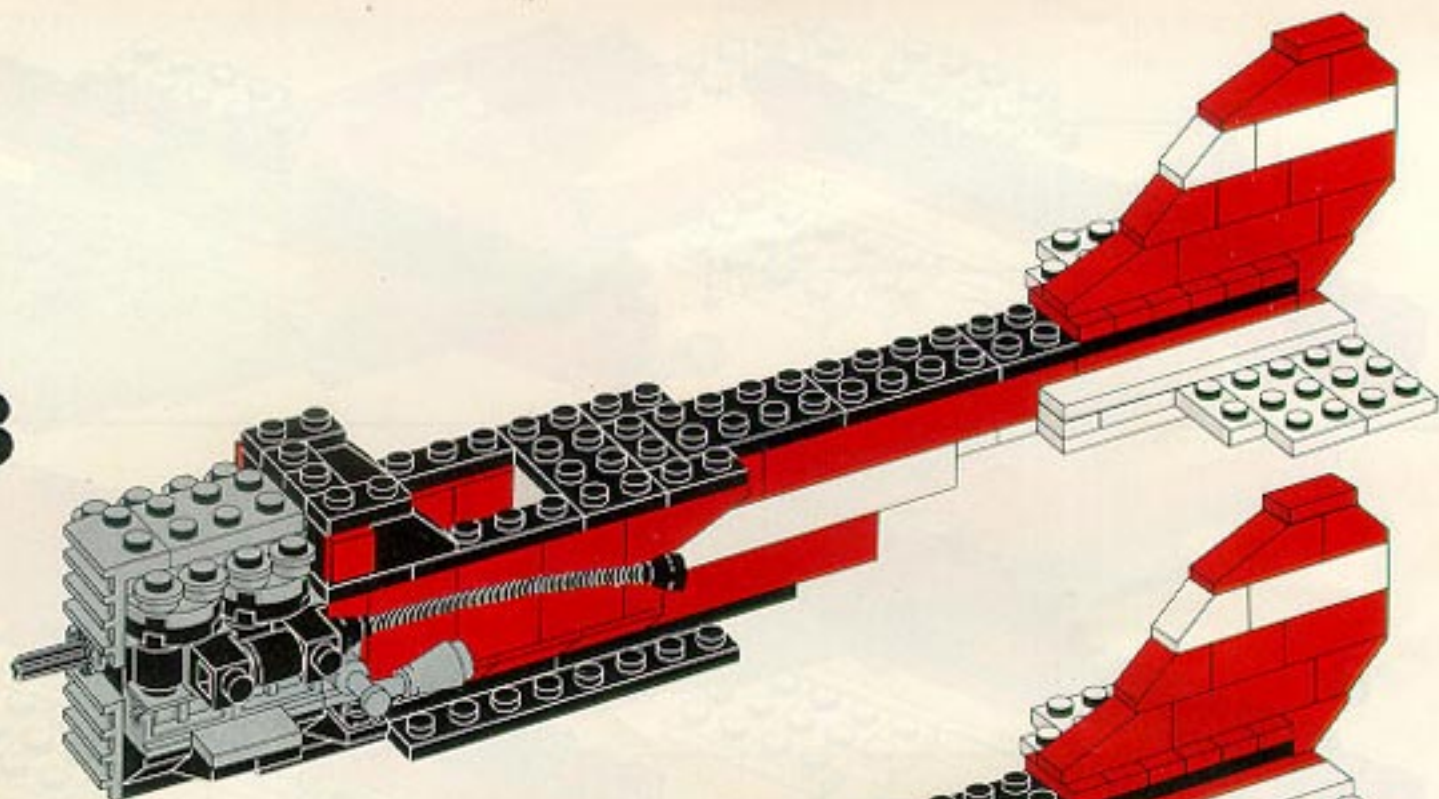

14

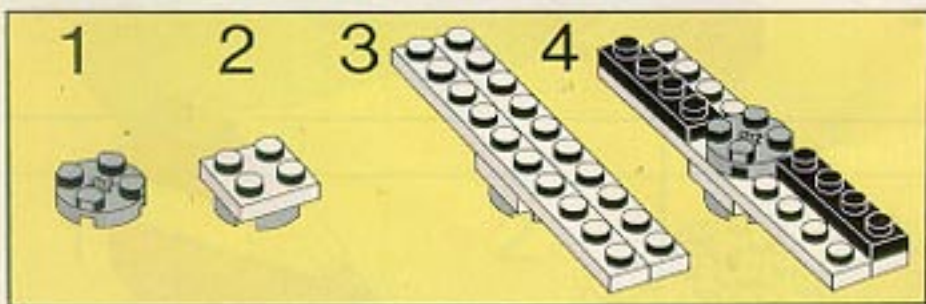
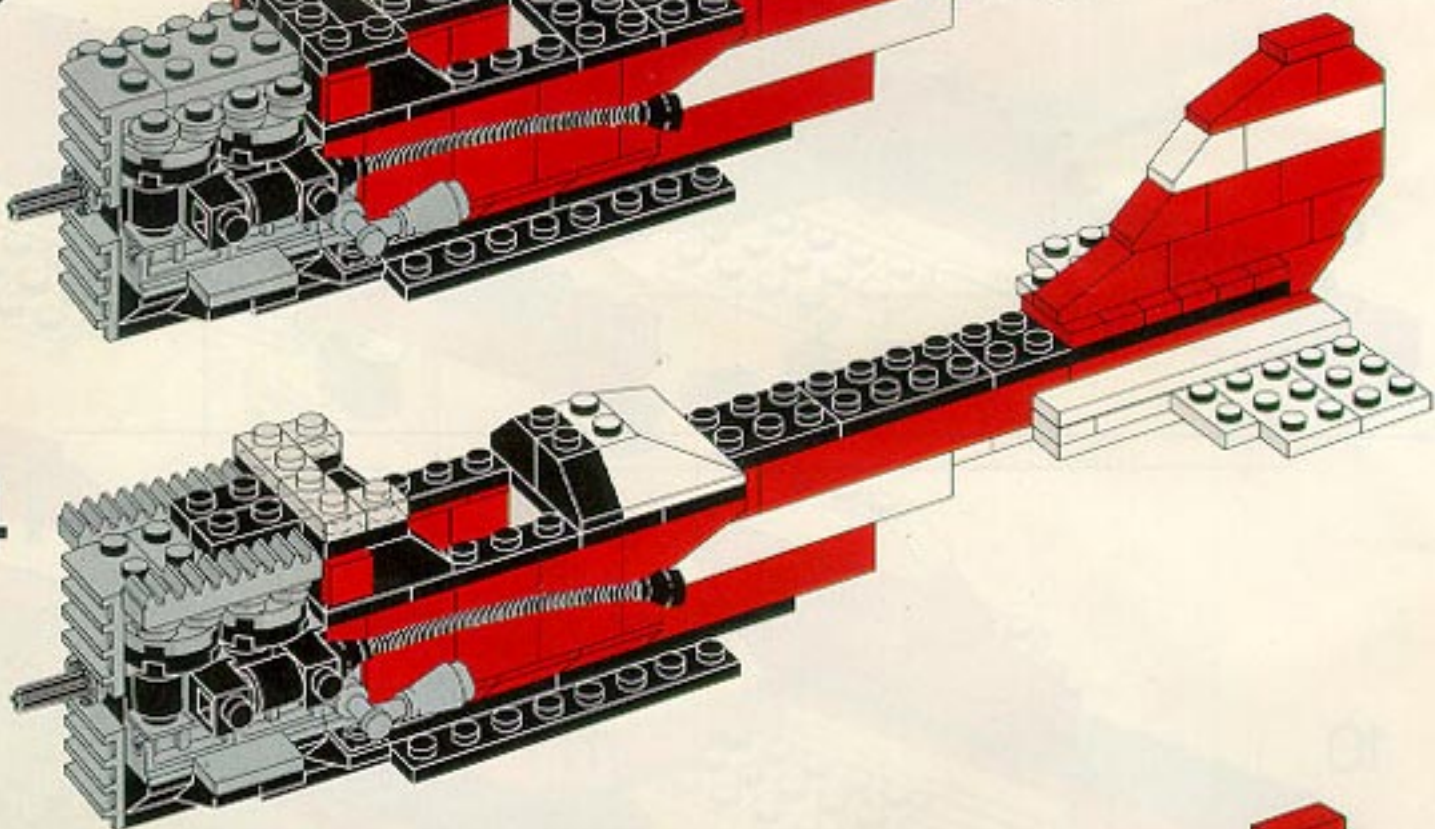

15

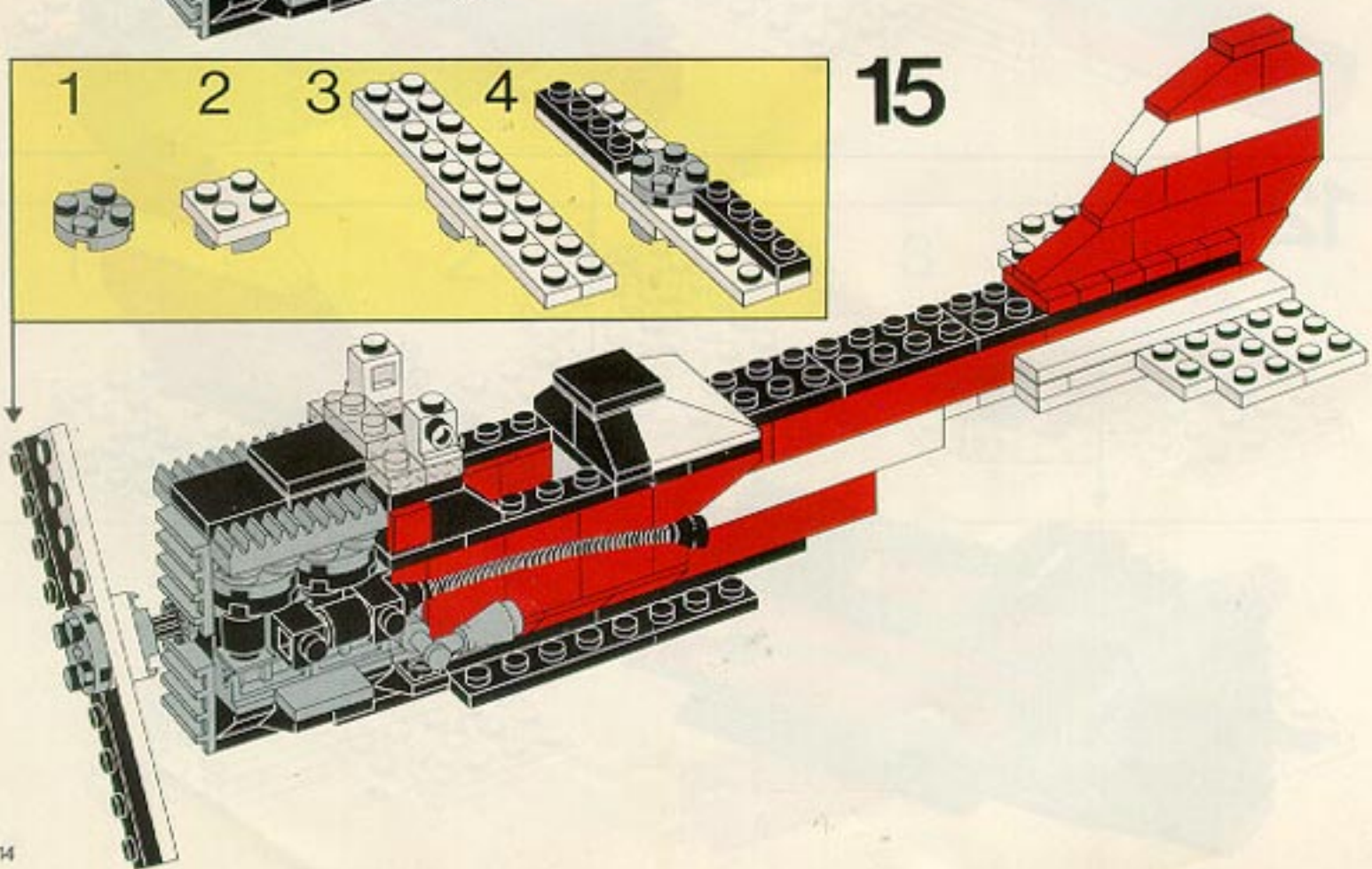

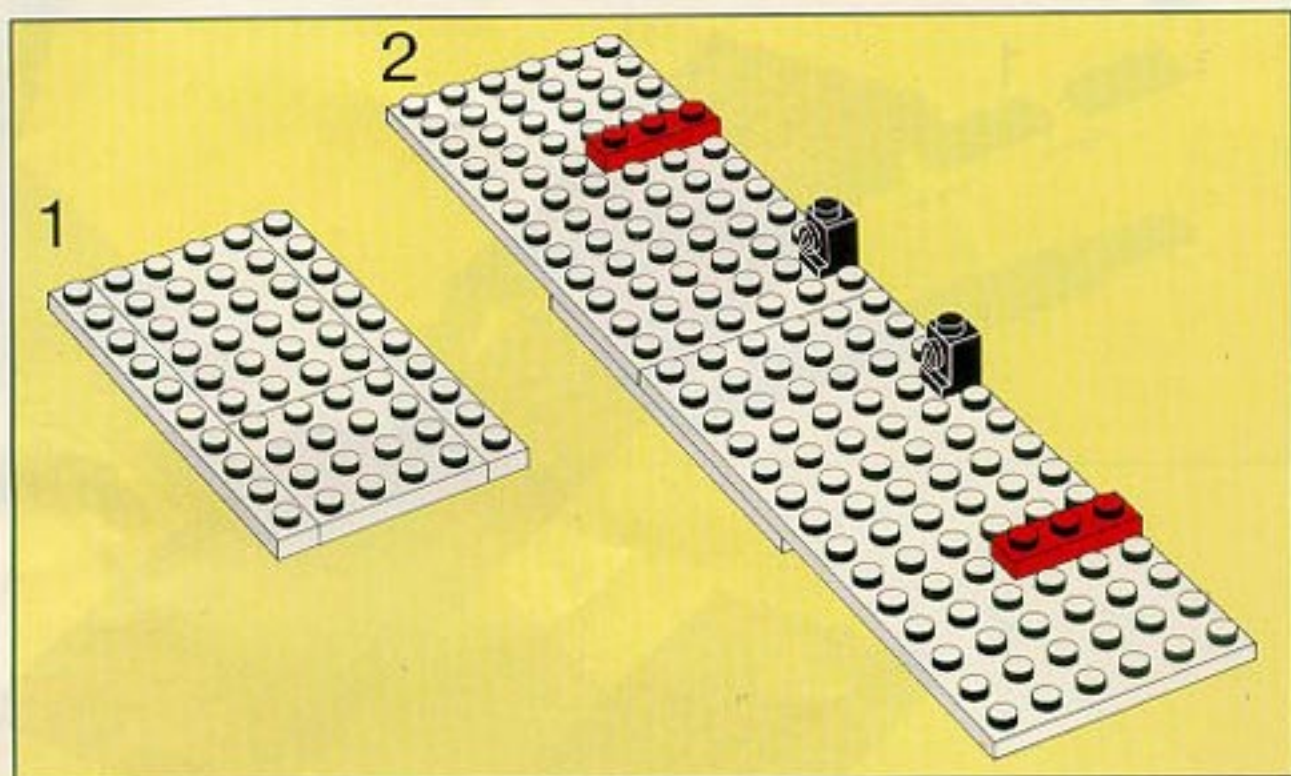

16

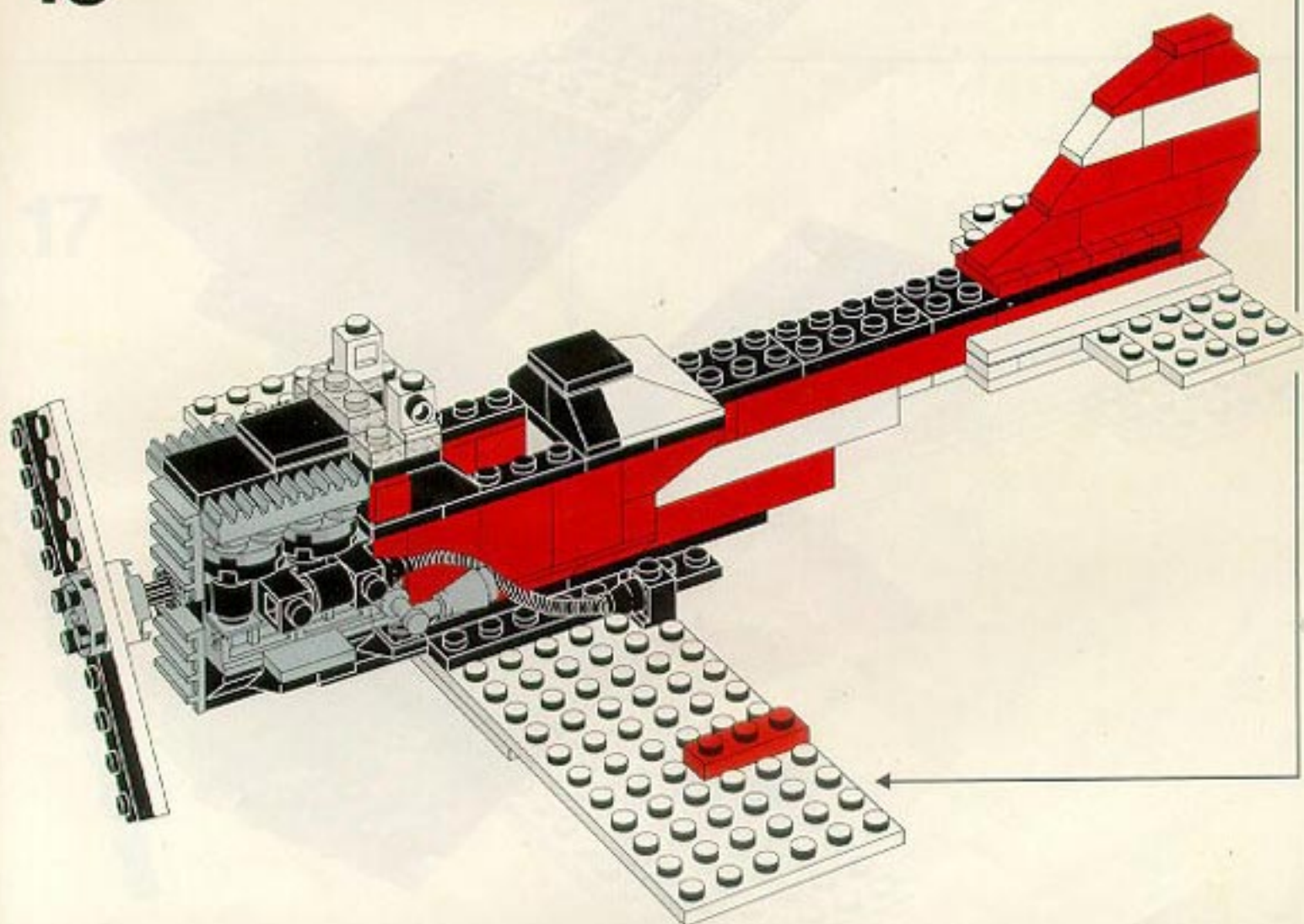

1

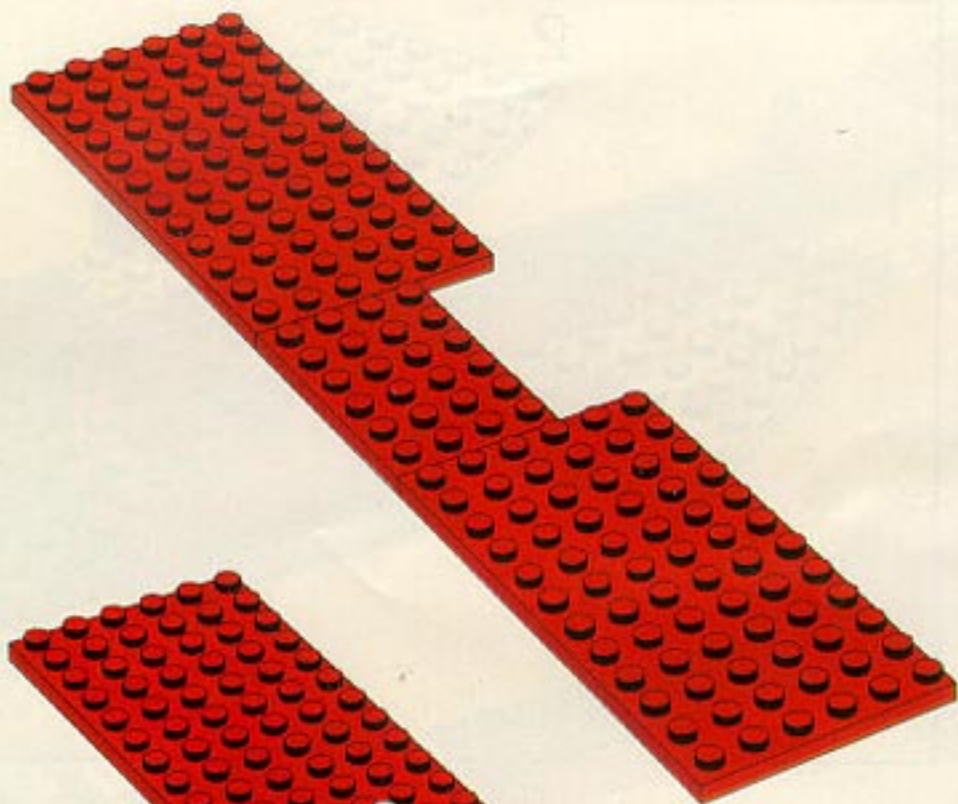

2

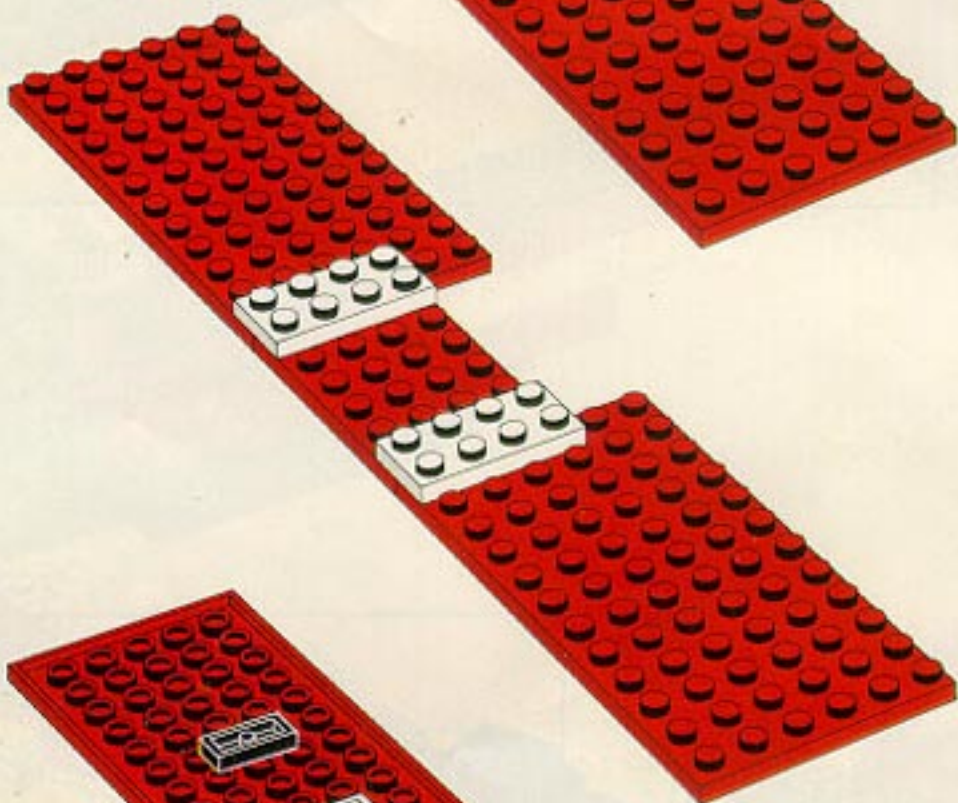

3

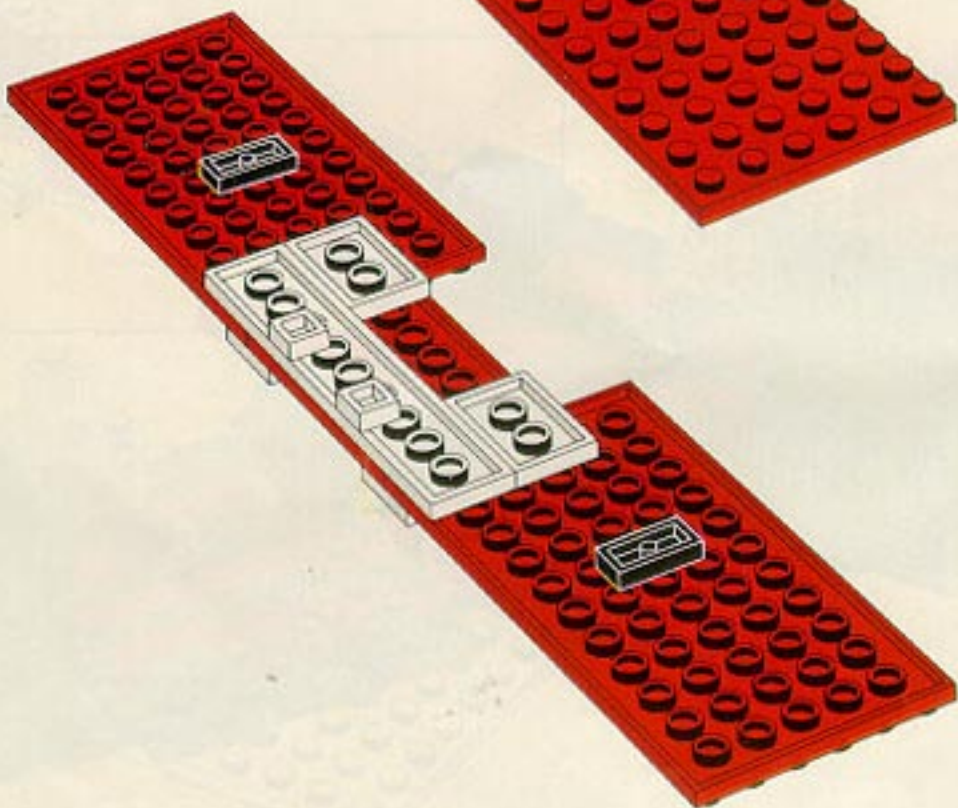



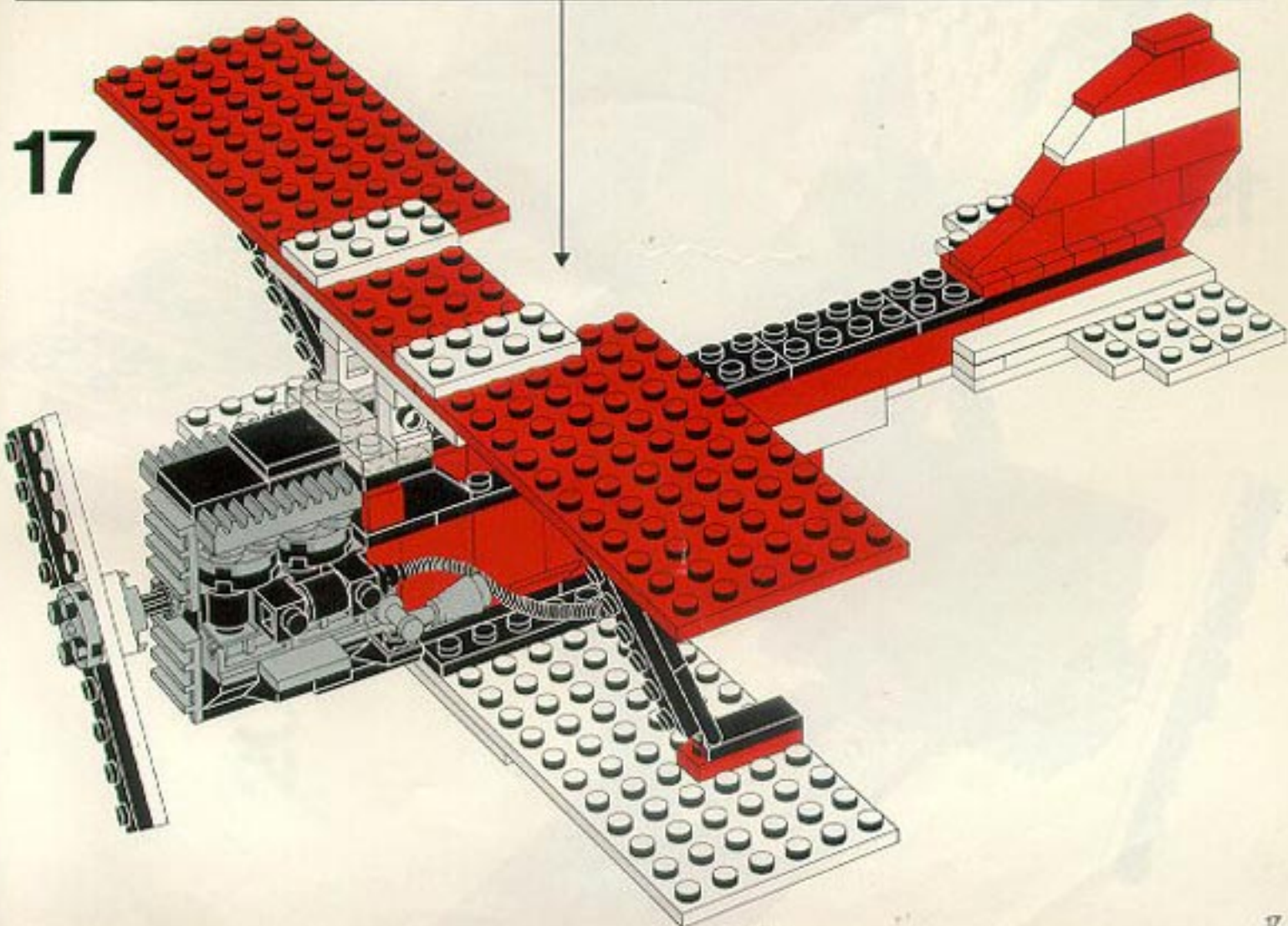
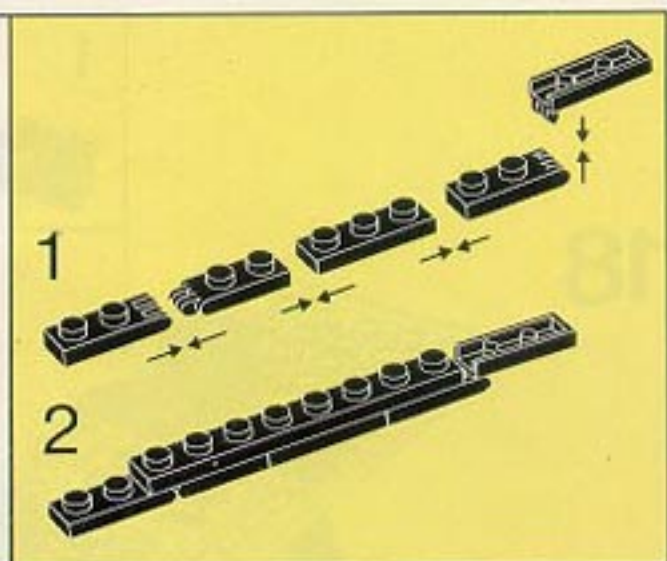
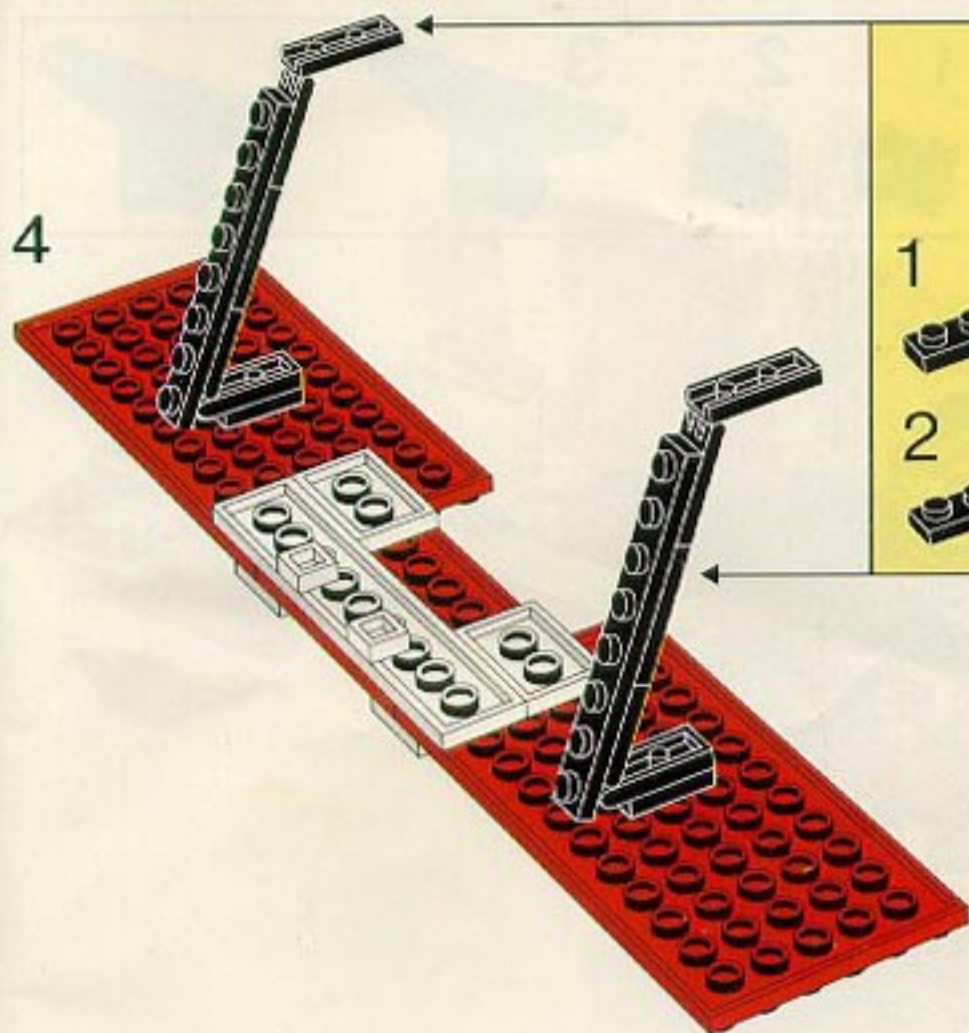



18

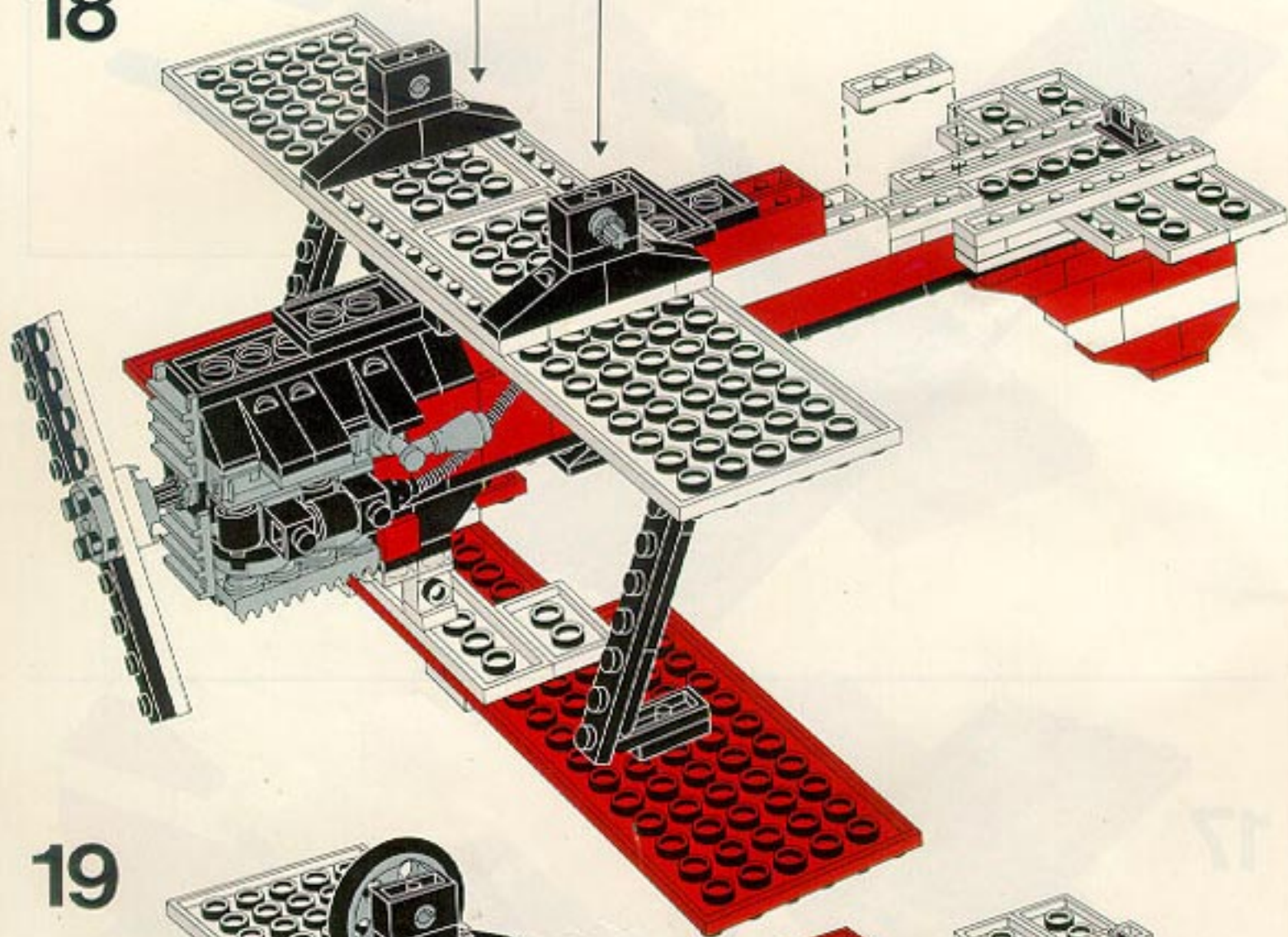



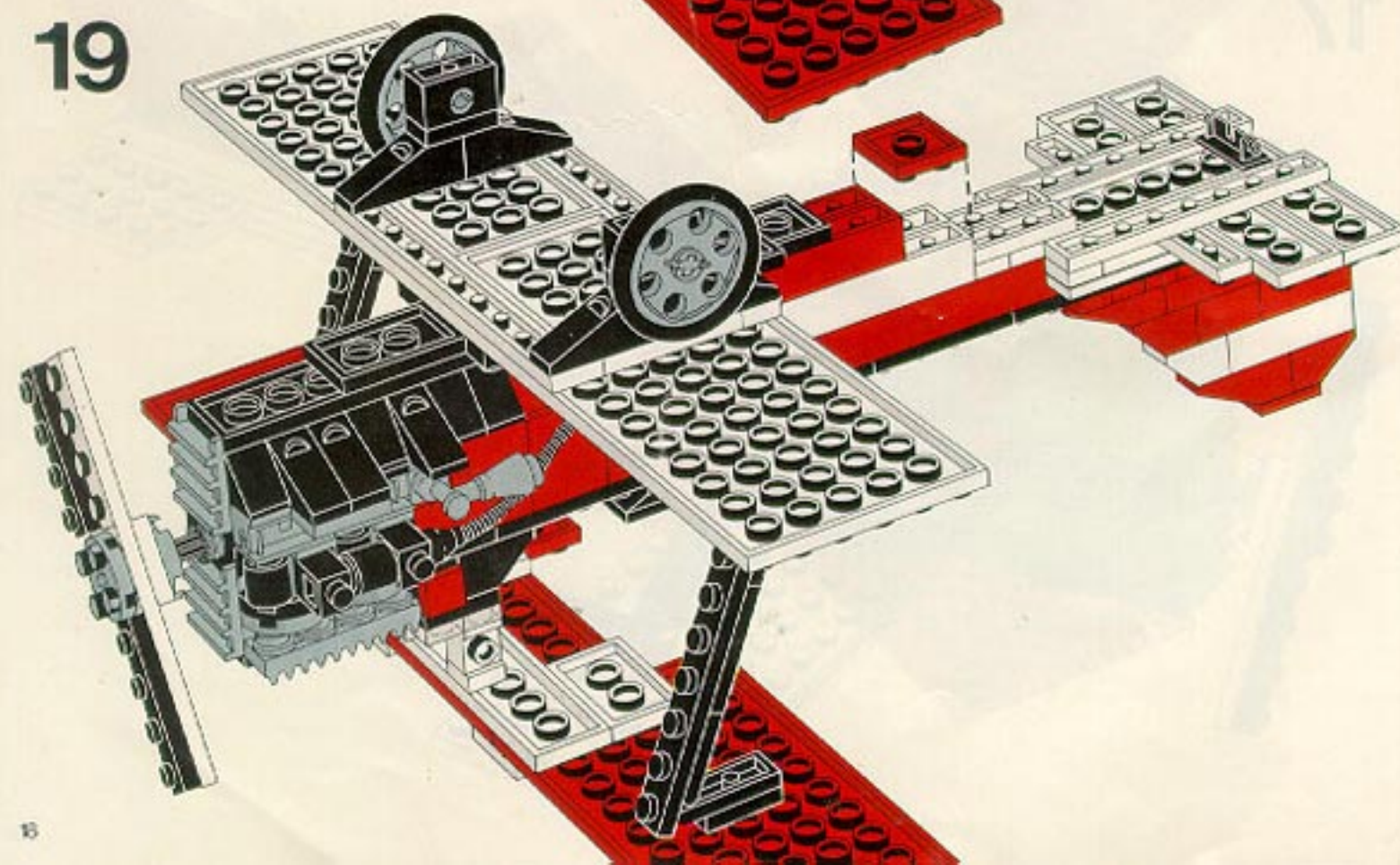

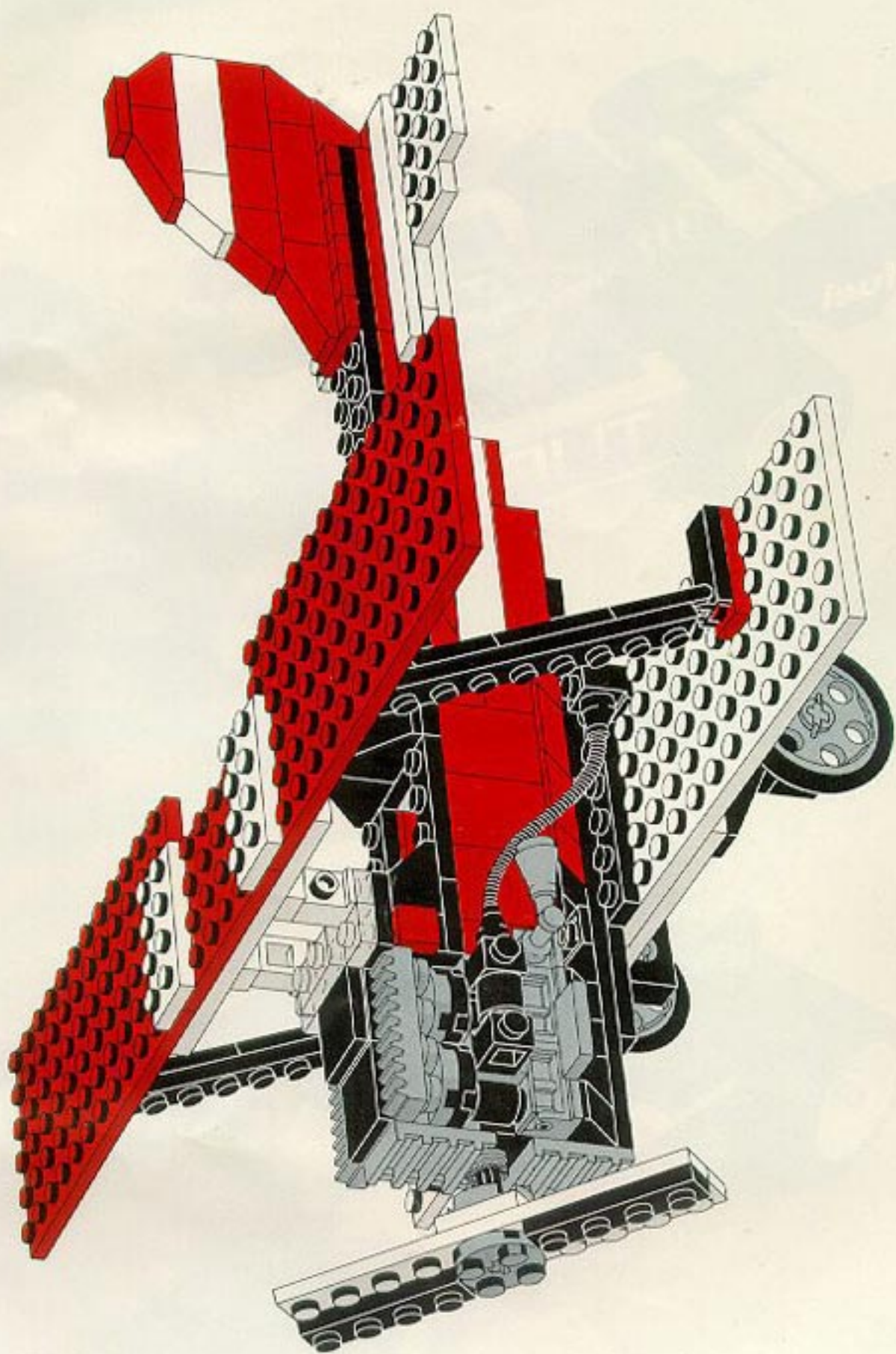



19





20

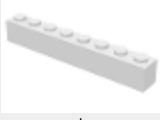

Image	Qty	Item No	Description	MID
<b>Regular Items:</b>				
<b>Parts:</b>				
+ 	1	<a href="#">4083</a>	<b>Light Gray Bar 1 x 4 x 2 with Studs</b> <a href="#">Catalog: Parts: Bar</a>	<a href="#">PG</a>
* 	4	<a href="#">3004</a>	<b>Black Brick 1 x 2</b> <a href="#">Catalog: Parts: Brick</a>	<a href="#">PG</a>
* 	5	<a href="#">3004</a>	<b>Red Brick 1 x 2</b> <a href="#">Catalog: Parts: Brick</a>	<a href="#">PG</a>
+ 	3	<a href="#">3004</a>	<b>White Brick 1 x 2</b> <a href="#">Catalog: Parts: Brick</a>	<a href="#">PG</a>
* 	10	<a href="#">3622</a>	<b>Red Brick 1 x 3</b> <a href="#">Catalog: Parts: Brick</a>	<a href="#">PG</a>
+ 	4	<a href="#">3010</a>	<b>Black Brick 1 x 4</b> <a href="#">Catalog: Parts: Brick</a>	<a href="#">PG</a>
* 	3	<a href="#">3010</a>	<b>Red Brick 1 x 4</b> <a href="#">Catalog: Parts: Brick</a>	<a href="#">PG</a>
+ 	3	<a href="#">3010</a>	<b>White Brick 1 x 4</b> <a href="#">Catalog: Parts: Brick</a>	<a href="#">PG</a>
* 	2	<a href="#">3009</a>	<b>Red Brick 1 x 6</b> <a href="#">Catalog: Parts: Brick</a>	<a href="#">PG</a>
+ 	4	<a href="#">3008</a>	<b>White Brick 1 x 8</b> <a href="#">Catalog: Parts: Brick</a>	<a href="#">PG</a>
* 	1	<a href="#">3003</a>	<b>Red Brick 2 x 2</b> <a href="#">Catalog: Parts: Brick</a>	<a href="#">PG</a>

+		1	<a href="#">3003</a>	<b>White Brick 2 x 2</b> <a href="#">Catalog:</a> <a href="#">Parts:</a> <a href="#">Brick</a>	<a href="#">PG</a>
---	--	---	----------------------	---	--------------------

+		1	<a href="#">3002</a>	<b>Light Gray Brick 2 x 3</b> <a href="#">Catalog:</a> <a href="#">Parts:</a> <a href="#">Brick</a>	<a href="#">PG</a>
---	---	---	----------------------	--	--------------------

+		1	<a href="#">3001</a>	<b>Light Gray Brick 2 x 4</b> <a href="#">Catalog:</a> <a href="#">Parts:</a> <a href="#">Brick</a>	<a href="#">PG</a>
---	---	---	----------------------	--	--------------------

+		1	<a href="#">3007</a>	<b>Red Brick 2 x 8</b> <a href="#">Catalog:</a> <a href="#">Parts:</a> <a href="#">Brick</a>	<a href="#">PG</a>
---	---	---	----------------------	---	--------------------

+		12	<a href="#">4070</a>	<b>Black Brick, Modified 1 x 1 with Headlight</b> <a href="#">Catalog:</a> <a href="#">Parts:</a> <a href="#">Brick, Modified</a>	<a href="#">PG</a>
---	---	----	----------------------	--	--------------------

+		8	<a href="#">4070</a>	<b>Light Gray Brick, Modified 1 x 1 with Headlight</b> <a href="#">Catalog:</a> <a href="#">Parts:</a> <a href="#">Brick, Modified</a>	<a href="#">PG</a>
---	--	---	----------------------	---	--------------------

+		2	<a href="#">4070</a>	<b>White Brick, Modified 1 x 1 with Headlight</b> <a href="#">Catalog:</a> <a href="#">Parts:</a> <a href="#">Brick, Modified</a>	<a href="#">PG</a>
---	---	---	----------------------	--	--------------------

+		6	<a href="#">3062b</a>	<b>Black Brick, Round 1 x 1 Open Stud</b> <a href="#">Catalog:</a> <a href="#">Parts:</a> <a href="#">Brick, Round</a>	<a href="#">PG</a>
---	---	---	-----------------------	---	--------------------

+		2	<a href="#">4589</a>	<b>Light Gray Cone 1 x 1 without Top Groove</b> <a href="#">Catalog:</a> <a href="#">Parts:</a> <a href="#">Cone</a>	<a href="#">PG</a>
---	---	---	----------------------	---	--------------------

+		1	<a href="#">3937</a>	<b>Black Hinge Brick 1 x 2 Base</b> <a href="#">Catalog:</a> <a href="#">Parts:</a> <a href="#">Hinge</a>	<a href="#">PG</a>
---	---	---	----------------------	--	--------------------

+		4	<a href="#">3937</a>	<b>Light Gray Hinge Brick 1 x 2 Base</b> <a href="#">Catalog:</a> <a href="#">Parts:</a> <a href="#">Hinge</a>	<a href="#">PG</a>
---	---	---	----------------------	---	--------------------

+		1	<a href="#">3938</a>	<b>Black Hinge Brick 1 x 2 Top</b> <a href="#">Catalog:</a> <a href="#">Parts:</a> <a href="#">Hinge</a>	<a href="#">PG</a>
---	---	---	----------------------	---	--------------------

+	 *	4	<a href="#">3938</a>	<b>Light Gray Hinge Brick 1 x 2 Top</b> <a href="#">Catalog:</a> <a href="#">Parts:</a> <a href="#">Hinge</a>	<a href="#">PG</a>
---	---	---	----------------------	--	--------------------

+	 *	2	<a href="#">4276a</a>	<b>Black Hinge Plate 1 x 2 with 2 Fingers and Solid Studs</b> <a href="#">Catalog:</a> <a href="#">Parts:</a> <a href="#">Hinge</a>	<a href="#">PG</a>
---	--	---	-----------------------	--	--------------------

+	 *	4	<a href="#">4275a</a>	<b>Black Hinge Plate 1 x 2 with 3 Fingers and Solid Studs</b> <a href="#">Catalog:</a> <a href="#">Parts:</a> <a href="#">Hinge</a>	<a href="#">PG</a>
---	--	---	-----------------------	--	--------------------

+	 *	2	<a href="#">4531</a>	<b>Black Hinge Tile 1 x 2 1/2 with 2 Fingers on Top</b> <a href="#">Catalog:</a> <a href="#">Parts:</a> <a href="#">Hinge</a>	<a href="#">PG</a>
---	--	---	----------------------	--	--------------------

+	 *	2	<a href="#">73590c01a(inv)</a>	<b>Black Hose, Flexible 8.5L with Tabless Ends (Ends same color as Tube)</b> <a href="#">Catalog:</a> <a href="#">Parts:</a> <a href="#">Hose</a>	<a href="#">PG</a>
---	--	---	--------------------------------	--	--------------------

+	 *	2	<a href="#">73590c01a(inv)</a>	<b>Trans-Yellow Hose, Flexible 8.5L with Tabless Ends (Ends same color as Tube)</b> <a href="#">Catalog:</a> <a href="#">Parts:</a> <a href="#">Hose</a>	<a href="#">PG</a>
---	---	---	--------------------------------	---	--------------------

+	 *	12	<a href="#">4864a</a>	<b>Red Panel 1 x 2 x 2 - Solid Studs</b> <a href="#">Catalog:</a> <a href="#">Parts:</a> <a href="#">Panel</a>	<a href="#">PG</a>
---	--	----	-----------------------	---	--------------------

+	 *	2	<a href="#">3024</a>	<b>Black Plate 1 x 1</b> <a href="#">Catalog:</a> <a href="#">Parts:</a> <a href="#">Plate</a>	<a href="#">PG</a>
---	--	---	----------------------	---	--------------------

+	 *	4	<a href="#">3024</a>	<b>Red Plate 1 x 1</b> <a href="#">Catalog:</a> <a href="#">Parts:</a> <a href="#">Plate</a>	<a href="#">PG</a>
---	--	---	----------------------	---	--------------------

+	 *	2	<a href="#">3024</a>	<b>Trans-Clear Plate 1 x 1</b> <a href="#">Catalog:</a> <a href="#">Parts:</a> <a href="#">Plate</a>	<a href="#">PG</a>
---	--	---	----------------------	---	--------------------

+	 *	2	<a href="#">3024</a>	<b>Trans-Red Plate 1 x 1</b> <a href="#">Catalog:</a> <a href="#">Parts:</a> <a href="#">Plate</a>	<a href="#">PG</a>
---	--	---	----------------------	---	--------------------

+	 *	6	<a href="#">3024</a>	<b>White Plate 1 x 1</b> <a href="#">Catalog:</a> <a href="#">Parts:</a> <a href="#">Plate</a>	<a href="#">PG</a>
---	--	---	----------------------	---	--------------------

+		26	<a href="#">3023</a>	<b>Black Plate 1 x 2</b> <a href="#">Catalog: Parts: Plate</a>	<a href="#">PG</a>
---	--	----	----------------------	---	--------------------

+		2	<a href="#">3023</a>	<b>Light Gray Plate 1 x 2</b> <a href="#">Catalog: Parts: Plate</a>	<a href="#">PG</a>
---	---	---	----------------------	--	--------------------

+		12	<a href="#">3023</a>	<b>Red Plate 1 x 2</b> <a href="#">Catalog: Parts: Plate</a>	<a href="#">PG</a>
---	---	----	----------------------	---	--------------------

+		3	<a href="#">3023</a>	<b>Trans-Clear Plate 1 x 2</b> <a href="#">Catalog: Parts: Plate</a>	<a href="#">PG</a>
---	---	---	----------------------	---	--------------------

+		4	<a href="#">3023</a>	<b>White Plate 1 x 2</b> <a href="#">Catalog: Parts: Plate</a>	<a href="#">PG</a>
---	---	---	----------------------	---	--------------------

+		4	<a href="#">3623</a>	<b>Black Plate 1 x 3</b> <a href="#">Catalog: Parts: Plate</a>	<a href="#">PG</a>
---	--	---	----------------------	---	--------------------

+		4	<a href="#">3623</a>	<b>Red Plate 1 x 3</b> <a href="#">Catalog: Parts: Plate</a>	<a href="#">PG</a>
---	---	---	----------------------	---	--------------------

+		2	<a href="#">3623</a>	<b>White Plate 1 x 3</b> <a href="#">Catalog: Parts: Plate</a>	<a href="#">PG</a>
---	---	---	----------------------	---	--------------------

+		5	<a href="#">3710</a>	<b>Black Plate 1 x 4</b> <a href="#">Catalog: Parts: Plate</a>	<a href="#">PG</a>
---	---	---	----------------------	---	--------------------

+		4	<a href="#">3666</a>	<b>Red Plate 1 x 6</b> <a href="#">Catalog: Parts: Plate</a>	<a href="#">PG</a>
---	---	---	----------------------	---	--------------------

+		4	<a href="#">3460</a>	<b>Black Plate 1 x 8</b> <a href="#">Catalog: Parts: Plate</a>	<a href="#">PG</a>
---	---	---	----------------------	---	--------------------

+		4	<a href="#">3460</a>	<b>White Plate 1 x 8</b> <a href="#">Catalog: Parts: Plate</a>	<a href="#">PG</a>
---	---	---	----------------------	---	--------------------



+	 *	1	<a href="#">4477</a>	<b>Black Plate 1 x 10</b> <a href="#">Catalog: Parts: Plate</a>	<a href="#">PG</a>
---	---	---	----------------------	--	--------------------

+	 *	4	<a href="#">4477</a>	<b>White Plate 1 x 10</b> <a href="#">Catalog: Parts: Plate</a>	<a href="#">PG</a>
---	--	---	----------------------	--	--------------------

+	 *	1	<a href="#">3022</a>	<b>Red Plate 2 x 2</b> <a href="#">Catalog: Parts: Plate</a>	<a href="#">PG</a>
---	--	---	----------------------	---	--------------------

+	 *	1	<a href="#">3022</a>	<b>Trans-Clear Plate 2 x 2</b> <a href="#">Catalog: Parts: Plate</a>	<a href="#">PG</a>
---	--	---	----------------------	---	--------------------

+	 *	2	<a href="#">3022</a>	<b>White Plate 2 x 2</b> <a href="#">Catalog: Parts: Plate</a>	<a href="#">PG</a>
---	--	---	----------------------	---	--------------------

+	 *	2	<a href="#">3021</a>	<b>Black Plate 2 x 3</b> <a href="#">Catalog: Parts: Plate</a>	<a href="#">PG</a>
---	--	---	----------------------	---	--------------------

+	 *	1	<a href="#">3021</a>	<b>Light Gray Plate 2 x 3</b> <a href="#">Catalog: Parts: Plate</a>	<a href="#">PG</a>
---	--	---	----------------------	--	--------------------

+	 *	2	<a href="#">3021</a>	<b>White Plate 2 x 3</b> <a href="#">Catalog: Parts: Plate</a>	<a href="#">PG</a>
---	--	---	----------------------	---	--------------------

+	 *	3	<a href="#">3020</a>	<b>Black Plate 2 x 4</b> <a href="#">Catalog: Parts: Plate</a>	<a href="#">PG</a>
---	--	---	----------------------	---	--------------------

+	 *	2	<a href="#">3020</a>	<b>Light Gray Plate 2 x 4</b> <a href="#">Catalog: Parts: Plate</a>	<a href="#">PG</a>
---	--	---	----------------------	--	--------------------

+	 *	2	<a href="#">3020</a>	<b>Red Plate 2 x 4</b> <a href="#">Catalog: Parts: Plate</a>	<a href="#">PG</a>
---	--	---	----------------------	---	--------------------

+	 *	1	<a href="#">3020</a>	<b>Trans-Clear Plate 2 x 4</b> <a href="#">Catalog: Parts: Plate</a>	<a href="#">PG</a>
---	--	---	----------------------	---	--------------------

+  3 [3020](#) **White Plate 2 x 4** [Catalog: Parts: Plate](#) [PG](#)  
\*

+  4 [3795](#) **Black Plate 2 x 6** [Catalog: Parts: Plate](#) [PG](#)  
\*

+  1 [3795](#) **Red Plate 2 x 6** [Catalog: Parts: Plate](#) [PG](#)  
\*

+  1 [3034](#) **Black Plate 2 x 8** [Catalog: Parts: Plate](#) [PG](#)  
\*

+  1 [3034](#) **White Plate 2 x 8** [Catalog: Parts: Plate](#) [PG](#)  
\*

+  1 [3832](#) **Black Plate 2 x 10** [Catalog: Parts: Plate](#) [PG](#)  
\*

+  3 [3832](#) **White Plate 2 x 10** [Catalog: Parts: Plate](#) [PG](#)  
\*

+  1 [3031](#) **Black Plate 4 x 4** [Catalog: Parts: Plate](#) [PG](#)  
\*

+  1 [3031](#) **White Plate 4 x 4** [Catalog: Parts: Plate](#) [PG](#)  
\*

+  1 [3032](#) **Red Plate 4 x 6** [Catalog: Parts: Plate](#) [PG](#)  
\*

+  1 [3032](#) **White Plate 4 x 6** [Catalog: Parts: Plate](#) [PG](#)  
\*

+  1 [3035](#) **Black Plate 4 x 8** [Catalog: Parts: Plate](#) [PG](#)  
\*

+	 *	2	<a href="#">3028</a>	<b>Red Plate 6 x 12</b> <a href="#">Catalog: Parts: Plate</a>	<a href="#">PG</a>
---	---	---	----------------------	--	--------------------

+	 *	1	<a href="#">3028</a>	<b>White Plate 6 x 12</b> <a href="#">Catalog: Parts: Plate</a>	<a href="#">PG</a>
---	--	---	----------------------	--	--------------------

+	 *	1	<a href="#">3456</a>	<b>White Plate 6 x 14</b> <a href="#">Catalog: Parts: Plate</a>	<a href="#">PG</a>
---	--	---	----------------------	--	--------------------

+	 *	6	<a href="#">3794a</a>	<b>Red Plate, Modified 1 x 2 with 1 Stud without Groove (Jumper)</b> <a href="#">Catalog: Parts: Plate, Modified</a>	<a href="#">PG</a>
---	--	---	-----------------------	---	--------------------

+	 *	4	<a href="#">4175</a>	<b>Light Gray Plate, Modified 1 x 2 with Ladder</b> <a href="#">Catalog: Parts: Plate, Modified</a>	<a href="#">PG</a>
---	--	---	----------------------	--	--------------------

+	 *	8	<a href="#">4073</a>	<b>Light Gray Plate, Round 1 x 1</b> <a href="#">Catalog: Parts: Plate, Round</a>	<a href="#">PG</a>
---	--	---	----------------------	--	--------------------

+	 *	4	<a href="#">4032</a>	<b>Black Plate, Round 2 x 2 with Axle Hole</b> <a href="#">Catalog: Parts: Plate, Round</a>	<a href="#">PG</a>
---	--	---	----------------------	--	--------------------

+	 *	6	<a href="#">4032</a>	<b>Light Gray Plate, Round 2 x 2 with Axle Hole</b> <a href="#">Catalog: Parts: Plate, Round</a>	<a href="#">PG</a>
---	--	---	----------------------	---	--------------------

+	 *	8	<a href="#">4286</a>	<b>Black Slope 33 3 x 1</b> <a href="#">Catalog: Parts: Slope</a>	<a href="#">PG</a>
---	--	---	----------------------	--	--------------------

+	 *	4	<a href="#">4286</a>	<b>Light Gray Slope 33 3 x 1</b> <a href="#">Catalog: Parts: Slope</a>	<a href="#">PG</a>
---	--	---	----------------------	---	--------------------

+	 *	4	<a href="#">4286</a>	<b>Red Slope 33 3 x 1</b> <a href="#">Catalog: Parts: Slope</a>	<a href="#">PG</a>
---	--	---	----------------------	--	--------------------

+	 *	4	<a href="#">4286</a>	<b>White Slope 33 3 x 1</b> <a href="#">Catalog: Parts: Slope</a>	<a href="#">PG</a>
---	--	---	----------------------	--	--------------------

+		3	<a href="#">3298</a>	<b>Red Slope 33 3 x 2</b> <a href="#">Catalog: Parts: Slope</a>	<a href="#">PG</a>
---	--	---	----------------------	--	--------------------

+		2	<a href="#">3298</a>	<b>White Slope 33 3 x 2</b> <a href="#">Catalog: Parts: Slope</a>	<a href="#">PG</a>
---	---	---	----------------------	--	--------------------

+		2	<a href="#">3675</a>	<b>Red Slope 33 3 x 3 Double Convex</b> <a href="#">Catalog: Parts: Slope</a>	<a href="#">PG</a>
---	---	---	----------------------	--	--------------------

+		4	<a href="#">3297</a>	<b>Red Slope 33 3 x 4</b> <a href="#">Catalog: Parts: Slope</a>	<a href="#">PG</a>
---	---	---	----------------------	--	--------------------

+		4	<a href="#">3040</a>	<b>Black Slope 45 2 x 1</b> <a href="#">Catalog: Parts: Slope</a>	<a href="#">PG</a>
---	---	---	----------------------	--	--------------------

+		2	<a href="#">3040</a>	<b>Red Slope 45 2 x 1</b> <a href="#">Catalog: Parts: Slope</a>	<a href="#">PG</a>
---	---	---	----------------------	--	--------------------

+		2	<a href="#">3040</a>	<b>White Slope 45 2 x 1</b> <a href="#">Catalog: Parts: Slope</a>	<a href="#">PG</a>
---	---	---	----------------------	--	--------------------









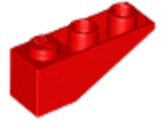

+		2	<a href="#">3040p32</a>	<b>White Slope 45 2 x 1 with 9 Large + 3 Small Black Buttons Pattern</b> <a href="#">Catalog: Parts: Slope, Decorated</a>	<a href="#">PG</a>
---	---	---	-------------------------	--	--------------------

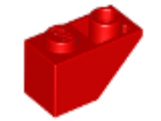
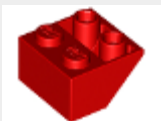
+		2	<a href="#">3039</a>	<b>White Slope 45 2 x 2</b> <a href="#">Catalog: Parts: Slope</a>	<a href="#">PG</a>
---	---	---	----------------------	--	--------------------

+		2	<a href="#">3045</a>	<b>White Slope 45 2 x 2 Double Convex</b> <a href="#">Catalog: Parts: Slope</a>	<a href="#">PG</a>
---	---	---	----------------------	--	--------------------

+		2	<a href="#">3037</a>	<b>White Slope 45 2 x 4</b> <a href="#">Catalog: Parts: Slope</a>	<a href="#">PG</a>
---	---	---	----------------------	--	--------------------

+		2	<a href="#">4861</a>	<b>White Slope 45 3 x 4 Double / 33</b> <a href="#">Catalog: Parts: Slope</a>	<a href="#">PG</a>
---	---	---	----------------------	--	--------------------

+	 *	10	<a href="#">4287</a>	<b>Black Slope, Inverted 33 3 x 1</b> <a href="#">Catalog: Parts: Slope, Inverted</a>	<a href="#">PG</a>
+	 *	2	<a href="#">4287</a>	<b>Red Slope, Inverted 33 3 x 1</b> <a href="#">Catalog: Parts: Slope, Inverted</a>	<a href="#">PG</a>
+	 *	8	<a href="#">3665</a>	<b>Black Slope, Inverted 45 2 x 1</b> <a href="#">Catalog: Parts: Slope, Inverted</a>	<a href="#">PG</a>
+	 *	4	<a href="#">3665</a>	<b>Red Slope, Inverted 45 2 x 1</b> <a href="#">Catalog: Parts: Slope, Inverted</a>	<a href="#">PG</a>
+	 *	4	<a href="#">3660</a>	<b>Red Slope, Inverted 45 2 x 2</b> <a href="#">Catalog: Parts: Slope, Inverted</a>	<a href="#">PG</a>
+	 *	1	<a href="#">5540stk01</a>	<b>Sticker for Set 5540 - (197915)</b> <a href="#">Catalog: Parts: Sticker</a>	<a href="#">PG</a>
+	 *	2	<a href="#">4599a</a>	<b>Light Gray Tap 1 x 1 with Hole in Nozzle End</b> <a href="#">Catalog: Parts: Tap</a>	<a href="#">PG</a>
+	 *	8	<a href="#">3713</a>	<b>Light Gray Technic Bush</b> <a href="#">Catalog: Parts: Technic</a>	<a href="#">PG</a>
+	 *	6	<a href="#">4265a</a>	<b>Light Gray Technic Bush 1/2 Toothed Type I</b> <a href="#">Catalog: Parts: Technic</a>	<a href="#">PG</a>
+	 *	2	<a href="#">4185</a>	<b>Light Gray Technic Wedge Belt Wheel (Pulley)</b> <a href="#">Catalog: Parts: Technic</a>	<a href="#">PG</a>
+	 *	2	<a href="#">2815</a>	<b>Black Technic Wedge Belt Wheel Tire</b> <a href="#">Catalog: Parts: Technic</a>	<a href="#">PG</a>
+	 *	1	<a href="#">3705</a>	<b>Black Technic, Axle 4</b> <a href="#">Catalog: Parts: Technic, Axle</a>	<a href="#">PG</a>

+	 *	2	<a href="#">3706</a>	<b>Black Technic, Axle 6</b> <a href="#">Catalog: Parts: Technic, Axle</a>	<a href="#">PG</a>
---	---	---	----------------------	---	--------------------

+	 *	3	<a href="#">3707</a>	<b>Black Technic, Axle 8</b> <a href="#">Catalog: Parts: Technic, Axle</a>	<a href="#">PG</a>
---	--	---	----------------------	---	--------------------

+	 *	14	<a href="#">3749</a>	<b>Light Gray Technic, Axle Pin without Friction Ridges Lengthwise</b> <a href="#">Catalog: Parts: Technic, Axle</a>	<a href="#">PG</a>
---	--	----	----------------------	---	--------------------

+	 *	4	<a href="#">3700</a>	<b>Black Technic, Brick 1 x 2 with Hole</b> <a href="#">Catalog: Parts: Technic, Brick</a>	<a href="#">PG</a>
---	--	---	----------------------	---	--------------------

+	 *	2	<a href="#">3894</a>	<b>Black Technic, Brick 1 x 6 with Holes</b> <a href="#">Catalog: Parts: Technic, Brick</a>	<a href="#">PG</a>
---	--	---	----------------------	--	--------------------

+	 *	1	<a href="#">4143</a>	<b>Light Gray Technic, Gear 14 Tooth Bevel</b> <a href="#">Catalog: Parts: Technic, Gear</a>	<a href="#">PG</a>
---	--	---	----------------------	---	--------------------

+	 *	2	<a href="#">3743</a>	<b>Light Gray Technic, Gear Rack 1 x 4</b> <a href="#">Catalog: Parts: Technic, Gear</a>	<a href="#">PG</a>
---	--	---	----------------------	---	--------------------

+	 *	4	<a href="#">4263</a>	<b>Black Technic, Plate 1 x 4 with Toothed Ends</b> <a href="#">Catalog: Parts: Technic, Plate</a>	<a href="#">PG</a>
---	--	---	----------------------	---	--------------------

+	 *	2	<a href="#">4262</a>	<b>Black Technic, Plate 1 x 6 with Toothed Ends</b> <a href="#">Catalog: Parts: Technic, Plate</a>	<a href="#">PG</a>
---	--	---	----------------------	---	--------------------

+	 *	2	<a href="#">4261</a>	<b>Light Gray Technic, Steering Arm</b> <a href="#">Catalog: Parts: Technic, Steering</a>	<a href="#">PG</a>
---	--	---	----------------------	--	--------------------

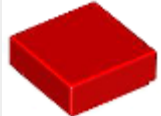
+	 *	2	<a href="#">3070b</a>	<b>Red Tile 1 x 1 with Groove (3070)</b> <a href="#">Catalog: Parts: Tile</a>	<a href="#">PG</a>
---	--	---	-----------------------	--	--------------------

+	 *	2	<a href="#">3070b</a>	<b>White Tile 1 x 1 with Groove (3070)</b> <a href="#">Catalog: Parts: Tile</a>	<a href="#">PG</a>
---	--	---	-----------------------	--	--------------------

+		1	<a href="#">3069b</a>	<b>Black Tile 1 x 2 with Groove</b> <a href="#">Catalog: Parts: Tile</a>	<a href="#">PG</a>
---	--	---	-----------------------	---	--------------------

+		3	<a href="#">3069b</a>	<b>Light Gray Tile 1 x 2 with Groove</b> <a href="#">Catalog: Parts: Tile</a>	<a href="#">PG</a>
---	---	---	-----------------------	--	--------------------

+		2	<a href="#">3069b</a>	<b>Red Tile 1 x 2 with Groove</b> <a href="#">Catalog: Parts: Tile</a>	<a href="#">PG</a>
---	---	---	-----------------------	---	--------------------

+		8	<a href="#">3069b</a>	<b>White Tile 1 x 2 with Groove</b> <a href="#">Catalog: Parts: Tile</a>	<a href="#">PG</a>
---	---	---	-----------------------	---	--------------------

+		2	<a href="#">4162</a>	<b>White Tile 1 x 8</b> <a href="#">Catalog: Parts: Tile</a>	<a href="#">PG</a>
---	---	---	----------------------	---	--------------------

+		3	<a href="#">3068b</a>	<b>Black Tile 2 x 2 with Groove</b> <a href="#">Catalog: Parts: Tile</a>	<a href="#">PG</a>
---	--	---	-----------------------	---	--------------------

+		1	<a href="#">4858</a>	<b>Red Wedge 4 x 4 Taper without Stud Notches</b> <a href="#">Catalog: Parts: Wedge</a>	<a href="#">PG</a>
---	---	---	----------------------	--	--------------------

+		10	<a href="#">2695c01(inv)</a>	<b>White Wheel 30mm D. x 13mm (13 x 24 Model Team), with Black Tire 13 x 24 Model Team (2695 / 2696)</b> <a href="#">Catalog: Parts: Wheel &amp; Tire Assembly</a>	<a href="#">PG</a>
---	---	----	------------------------------	---	--------------------

**Extra Items:**

+		1	<a href="#">3794a</a>	<b>Red Plate, Modified 1 x 2 with 1 Stud without Groove (Jumper)</b> <a href="#">Catalog: Parts: Plate, Modified</a>	<a href="#">PG</a>
---	---	---	-----------------------	---	--------------------

+		1	<a href="#">3713</a>	<b>Light Gray Technic Bush</b> <a href="#">Catalog: Parts: Technic</a>	<a href="#">PG</a>
---	---	---	----------------------	---	--------------------

+		1	<a href="#">4265a</a>	<b>Light Gray Technic Bush 1/2 Toothed Type I</b> <a href="#">Catalog: Parts: Technic</a>	<a href="#">PG</a>
---	---	---	-----------------------	--	--------------------

+		1	<a href="#">3070b</a>	<b>Red Tile 1 x 1 with Groove (3070)</b> <a href="#">Catalog: Parts: Tile</a>	<a href="#">PG</a>
---	--	---	-----------------------	--	--------------------



\*

+



\*

1

[3070b](#)**White Tile 1 x 1 with Groove (3070)**[Catalog:](#) [Parts:](#) [Tile](#)[PG](#)**Counterparts:**

+



\*

1

[3937c01\(inv\)](#)**Black Hinge Brick 1 x 2 Base with Same Color Hinge Brick 1 x 2 Top (3937 / 3938)**[Catalog:](#) [Parts:](#) [Hinge](#)[PG](#)

+



\*

4

[3937c01\(inv\)](#)**Light Gray Hinge Brick 1 x 2 Base with Same Color Hinge Brick 1 x 2 Top (3937 / 3938)**[Catalog:](#) [Parts:](#) [Hinge](#)[PG](#)

+



\*

2

[4185c01\(inv\)](#)**Light Gray Technic Wedge Belt Wheel (Pulley) with Black Technic Wedge Belt Wheel Tire (4185 / 2815)**[Catalog:](#) [Parts:](#) [Wheel & Tire Assembly](#)[PG](#)

+



\*

2

[3069bpb093](#)**White Tile 1 x 2 with Groove with 'NO SMOKING' Pattern (Sticker) - Set 5540**[Catalog:](#) [Parts:](#) [Tile\\_Decorated](#)[PG](#)

+



\*

2

[3069bpb070](#)**White Tile 1 x 2 with Groove with 'TURN OFF ENGINE' Pattern (Sticker) - Set 5540**[Catalog:](#) [Parts:](#) [Tile\\_Decorated](#)[PG](#)

+



\*

1

[4858pb08](#)**Red Wedge 4 x 4 Taper with White Number 1 Pattern (Sticker) - Set 5540**[Catalog:](#) [Parts:](#) [Wedge\\_Decorated](#)[PG](#)**Summary:**

Type	Unique Lots	Total Qty
<b>Regular Items:</b>		
Parts	127	440
<b>Extra Items:</b>		
Parts	5	5
<b>Counterparts:</b>		
Parts	6	12

[bytefox \(4409\)](#)  inventoried this Set on Apr 4, 2005, inventory last updated on May 9, 2019.