

**MODEL TEAM**

**5510**

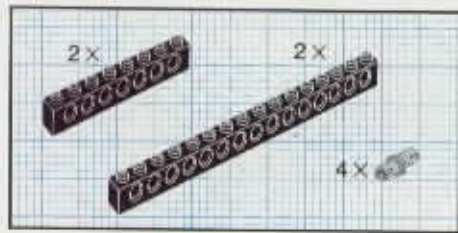

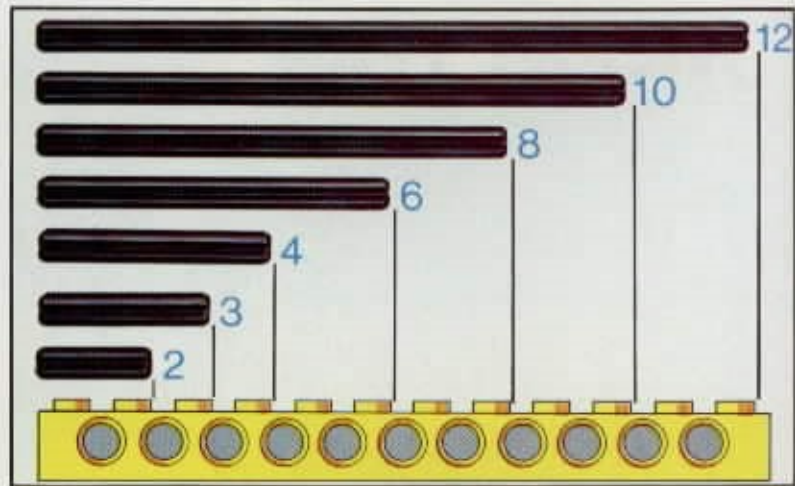



**1**

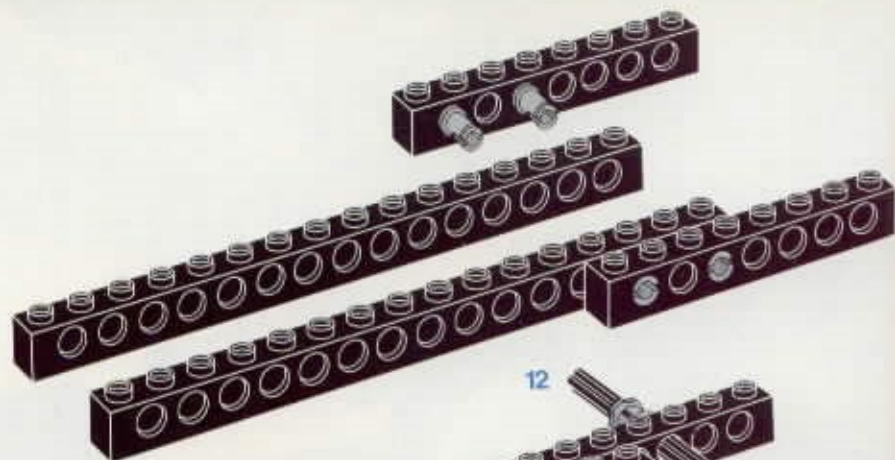

**2**

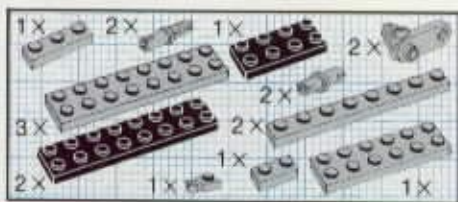
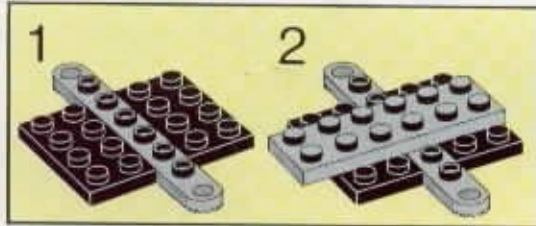

**3**

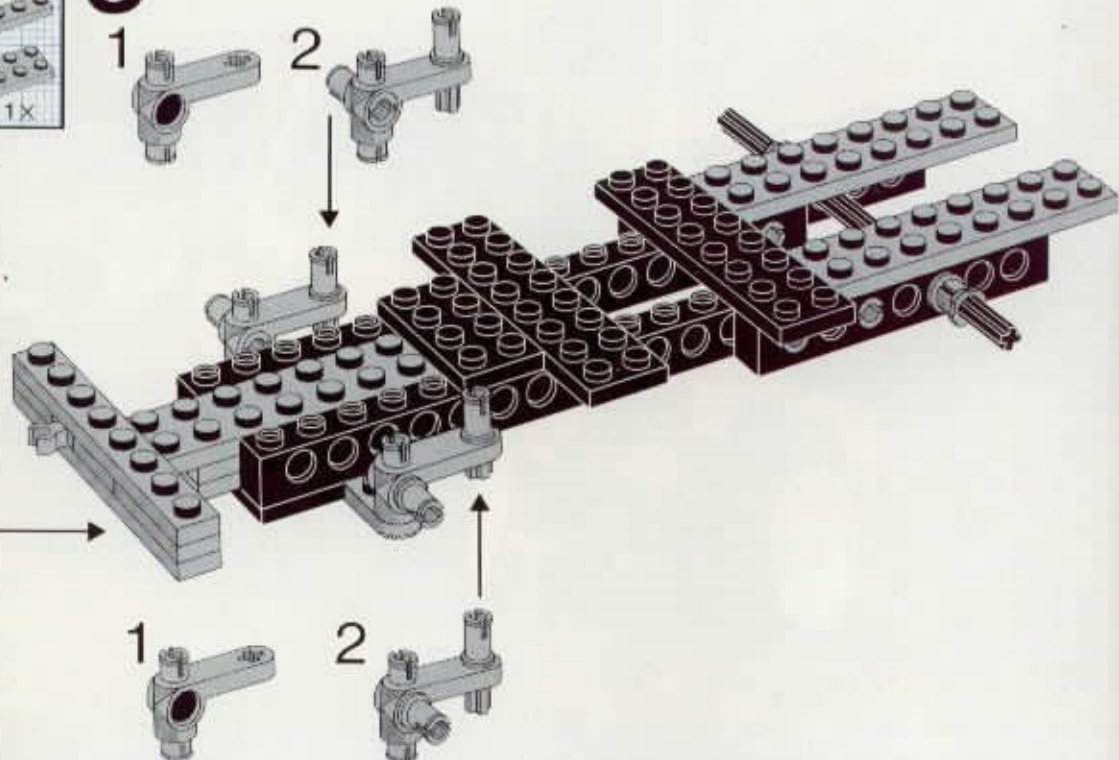
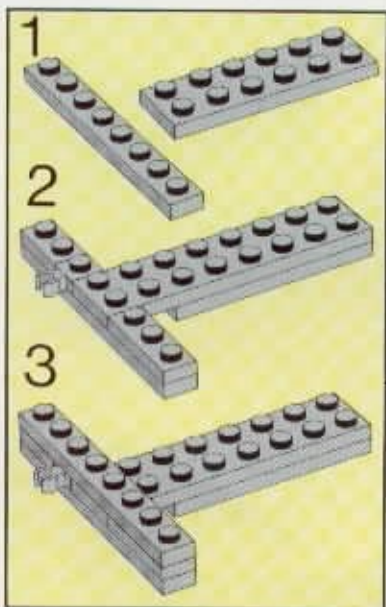



- 1x [dark grey 10-hole plate]
- 1x [grey 1-hole Technic brick]
- 1x [grey 1-hole Technic brick]
- 1x [grey 1-hole Technic brick]
- 1x [grey 1-hole Technic brick]
- 2x [grey 1-hole Technic brick]
- 1x [grey 1-hole Technic brick]
- 2x [grey 1-hole Technic brick]

4

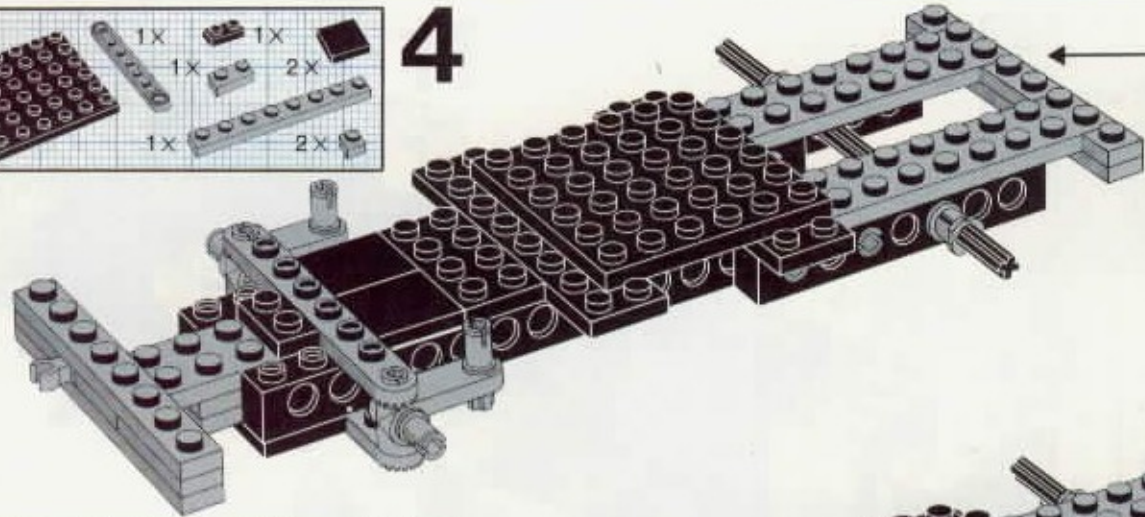

- 1 [grey 1-hole Technic brick]
- 2 [grey 1-hole Technic brick]

- 1x [yellow 1-hole Technic brick]
- 1x [grey 1-hole Technic brick]
- 1x [grey 1-hole Technic brick]
- 2x [dark grey 1-hole Technic brick]
- 2x [dark grey 1-hole Technic brick]

5

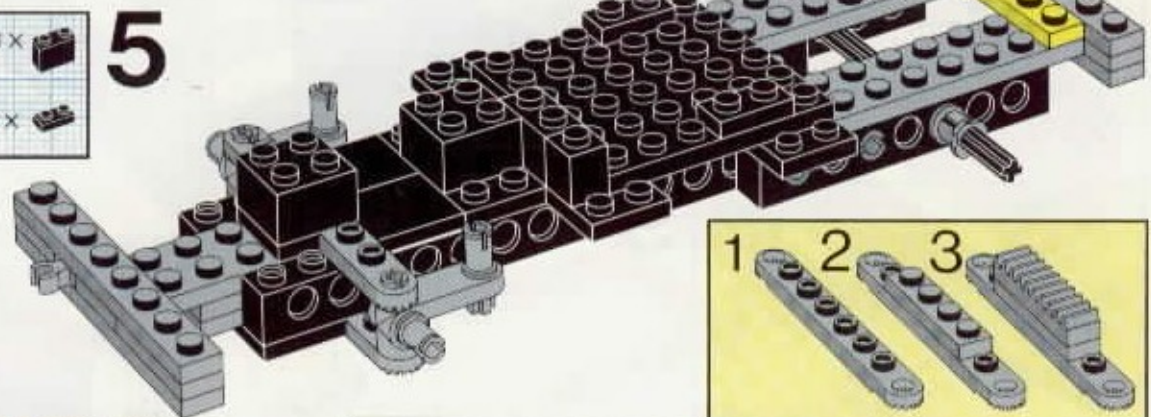

- 1 [grey 1-hole Technic brick]
- 2 [grey 1-hole Technic brick]
- 3 [grey 1-hole Technic brick]

- 1x [grey 1-hole Technic brick]
- 1x [grey 1-hole Technic brick]
- 1x [grey 1-hole Technic brick]
- 2x [yellow 1-hole Technic brick]
- 3x [dark grey 1-hole Technic brick]
- 1x [grey 1-hole Technic brick]
- 1x [grey 1-hole Technic brick]
- 1x [yellow 1-hole Technic brick]
- 4x [dark grey 1-hole Technic brick]

6

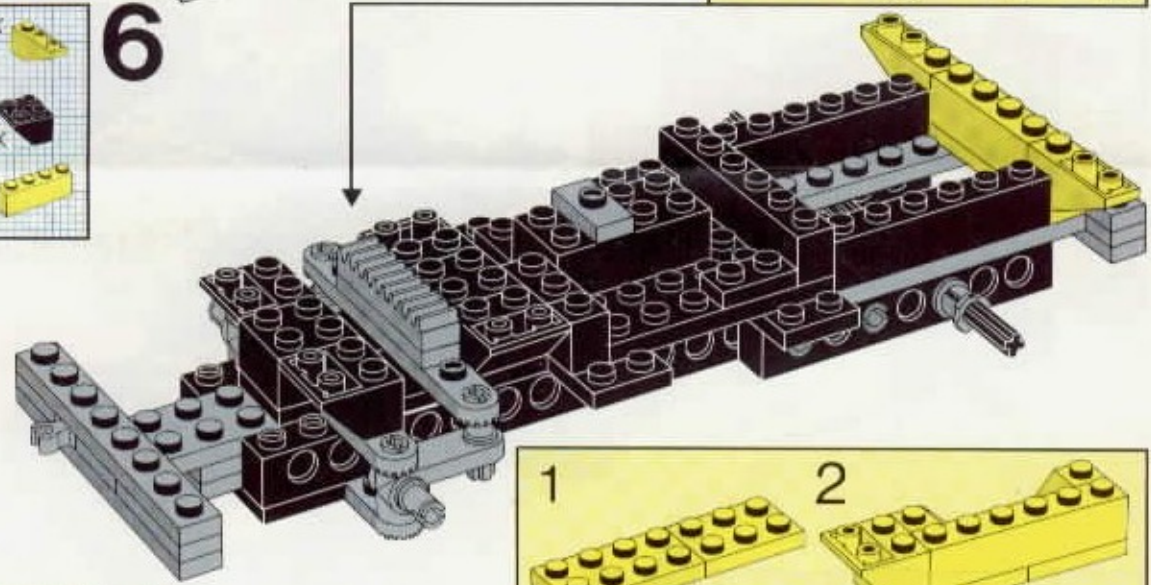

- 1 [yellow 1-hole Technic brick]
- 2 [yellow 1-hole Technic brick]

- 1x [dark grey 1-hole Technic brick]
- 2x [dark grey 1-hole Technic brick]
- 1x [yellow 1-hole Technic brick]
- 1x [dark grey 1-hole Technic brick]
- 1x [grey 1-hole Technic brick]
- 2x [yellow 1-hole Technic brick]
- 1x [dark grey 1-hole Technic brick]
- 3x [yellow 1-hole Technic brick]
- 2x [yellow 1-hole Technic brick]
- 1x [yellow 1-hole Technic brick]
- 4x [yellow 1-hole Technic brick]
- 1x [dark grey 1-hole Technic brick]

7

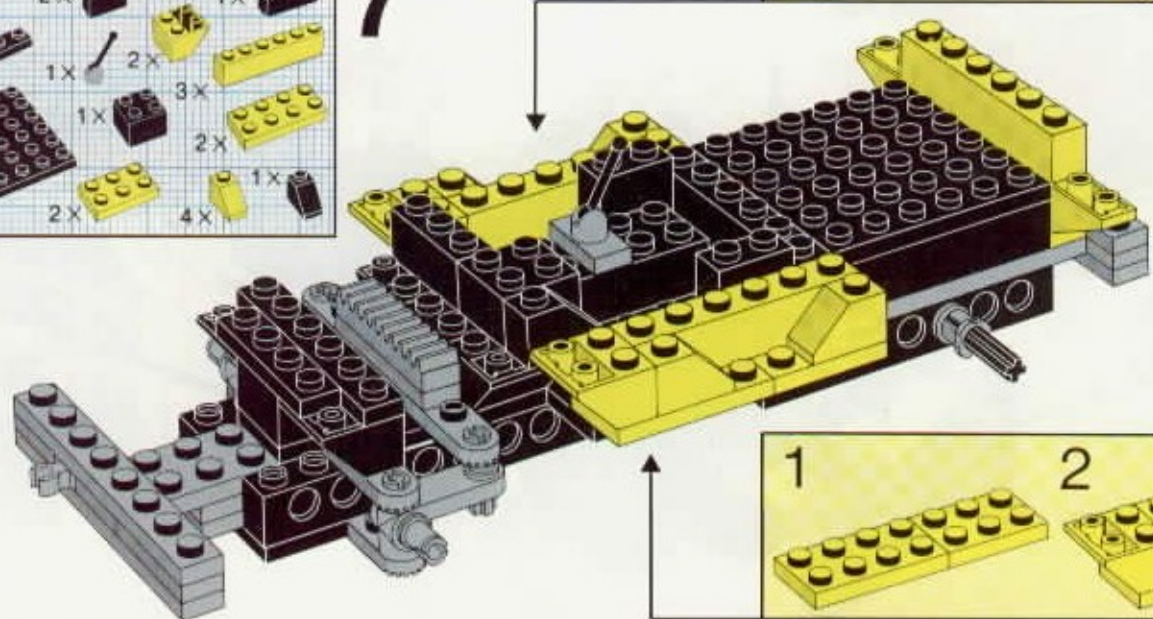

- 1 [yellow 1-hole Technic brick]
- 2 [yellow 1-hole Technic brick]



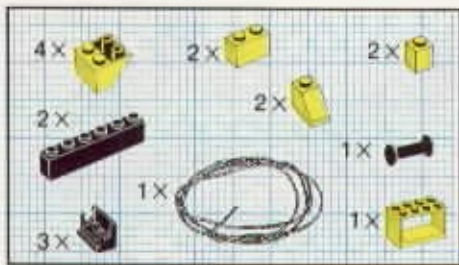

# 8

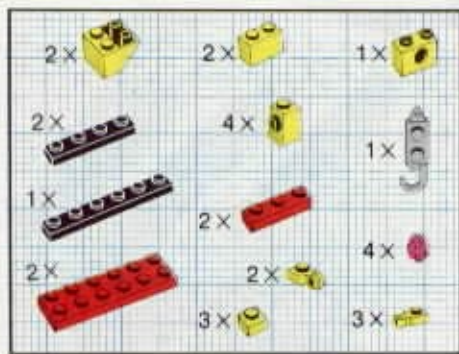
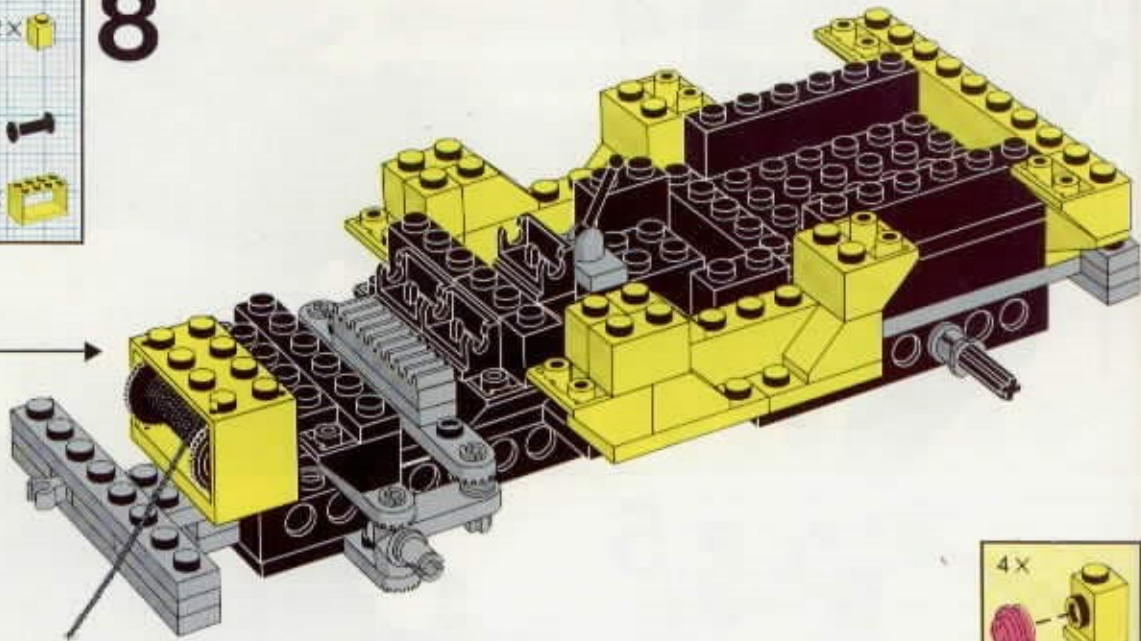
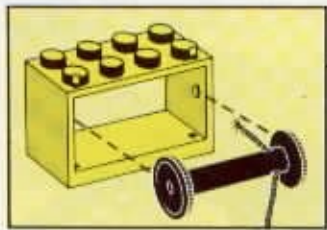

# 9

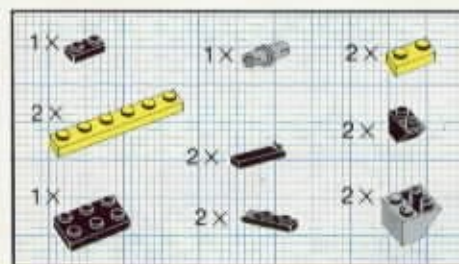
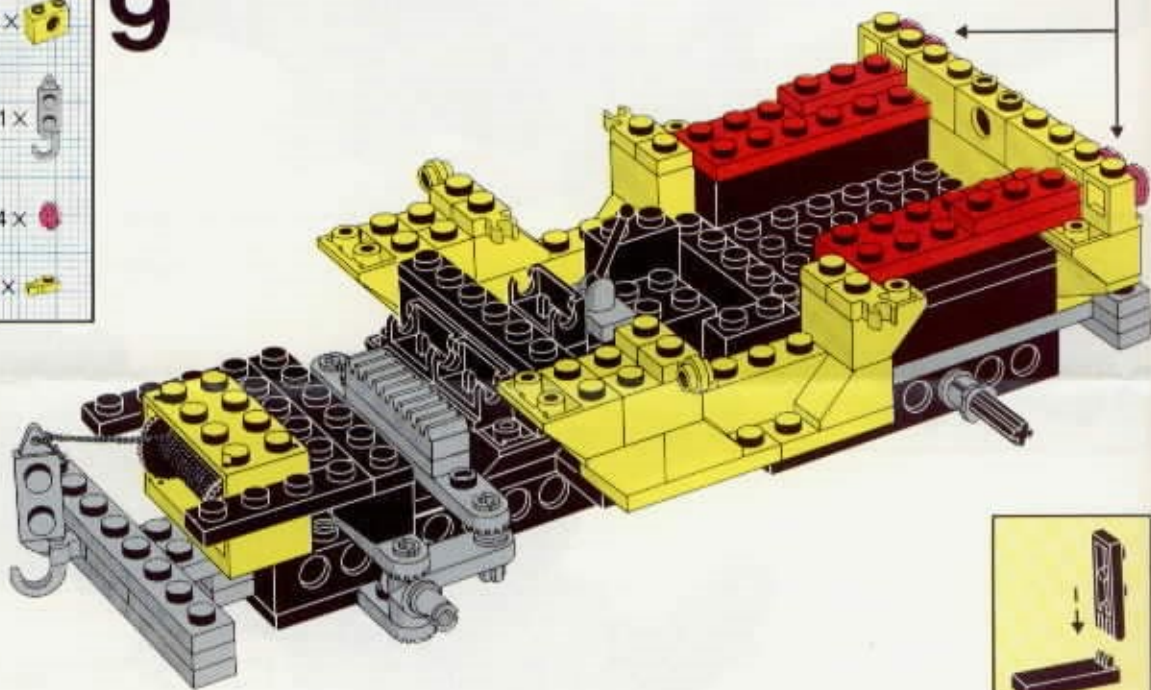
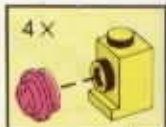

# 10

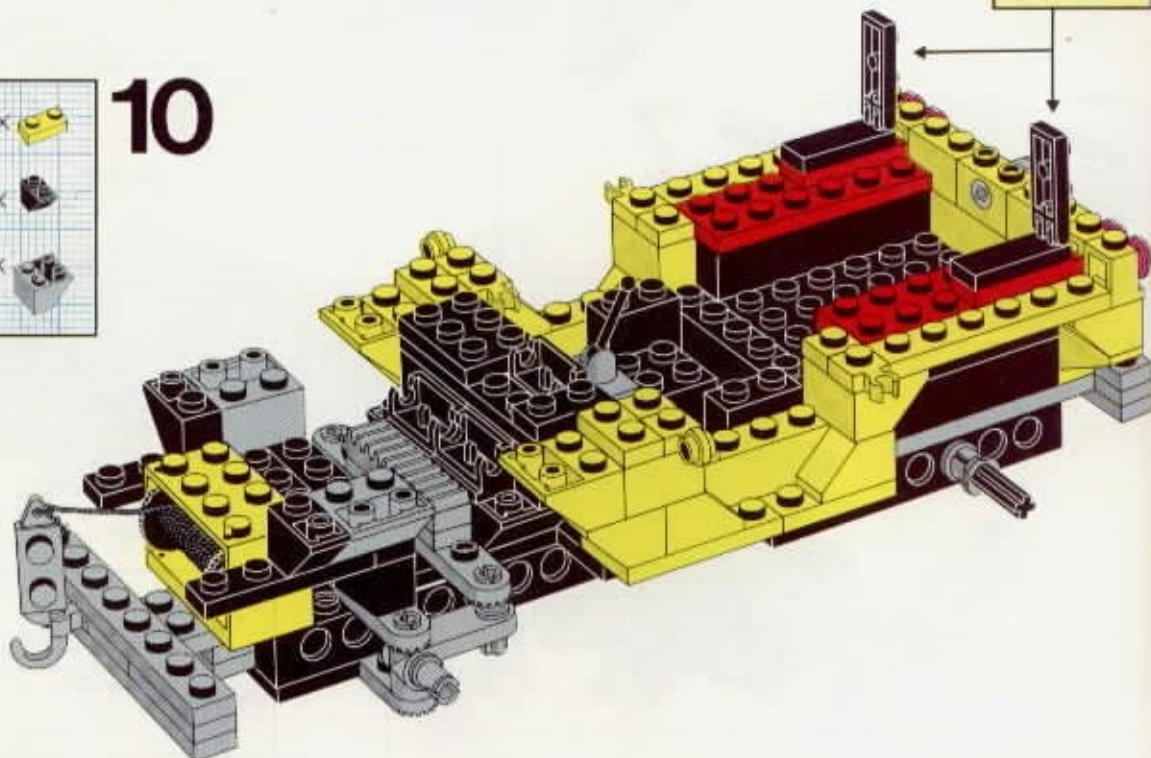







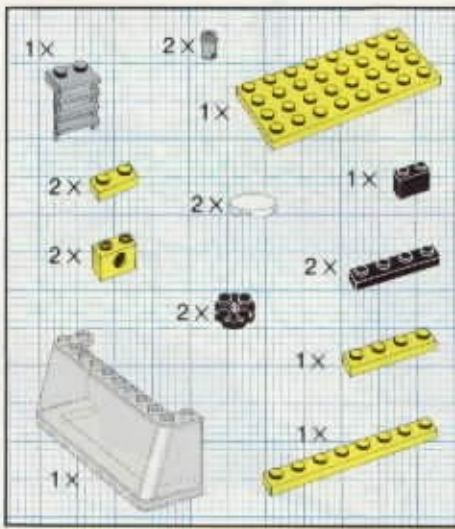

# 14

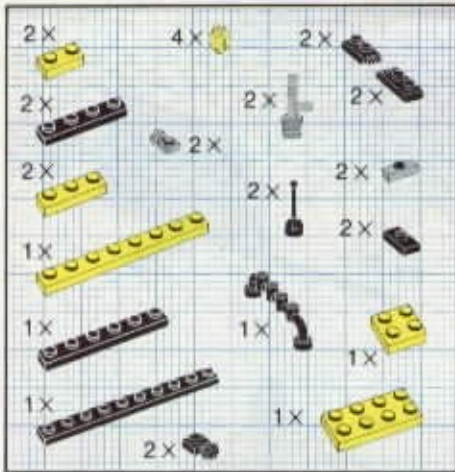
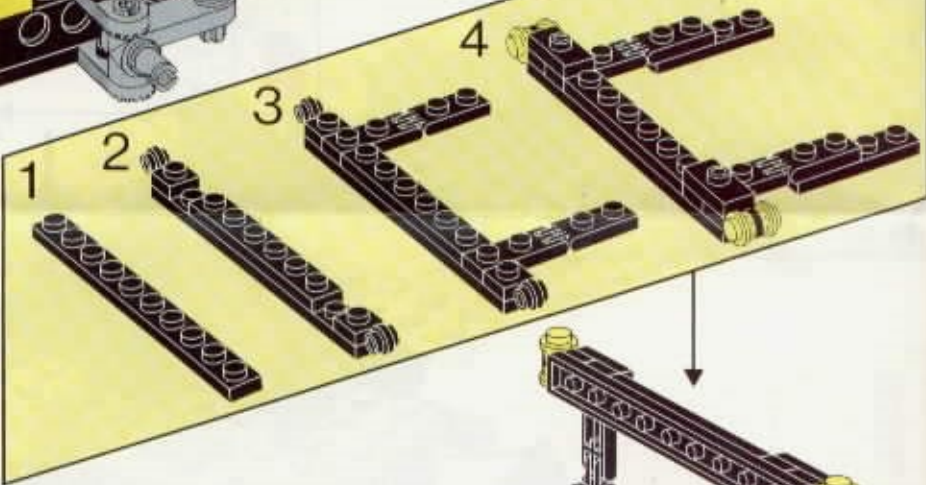
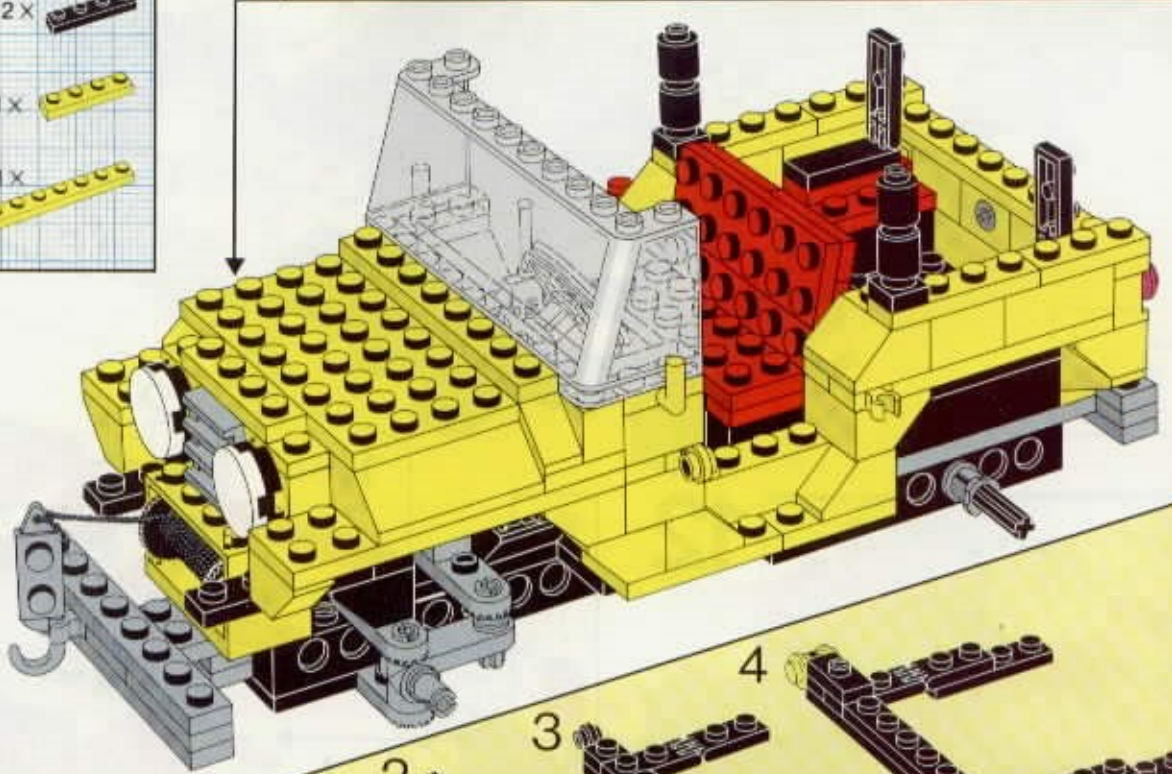
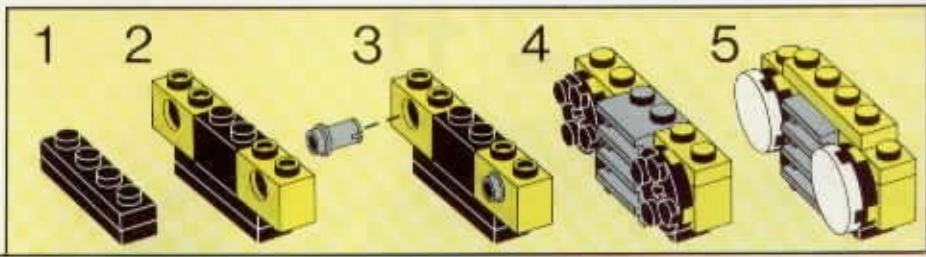

# 15

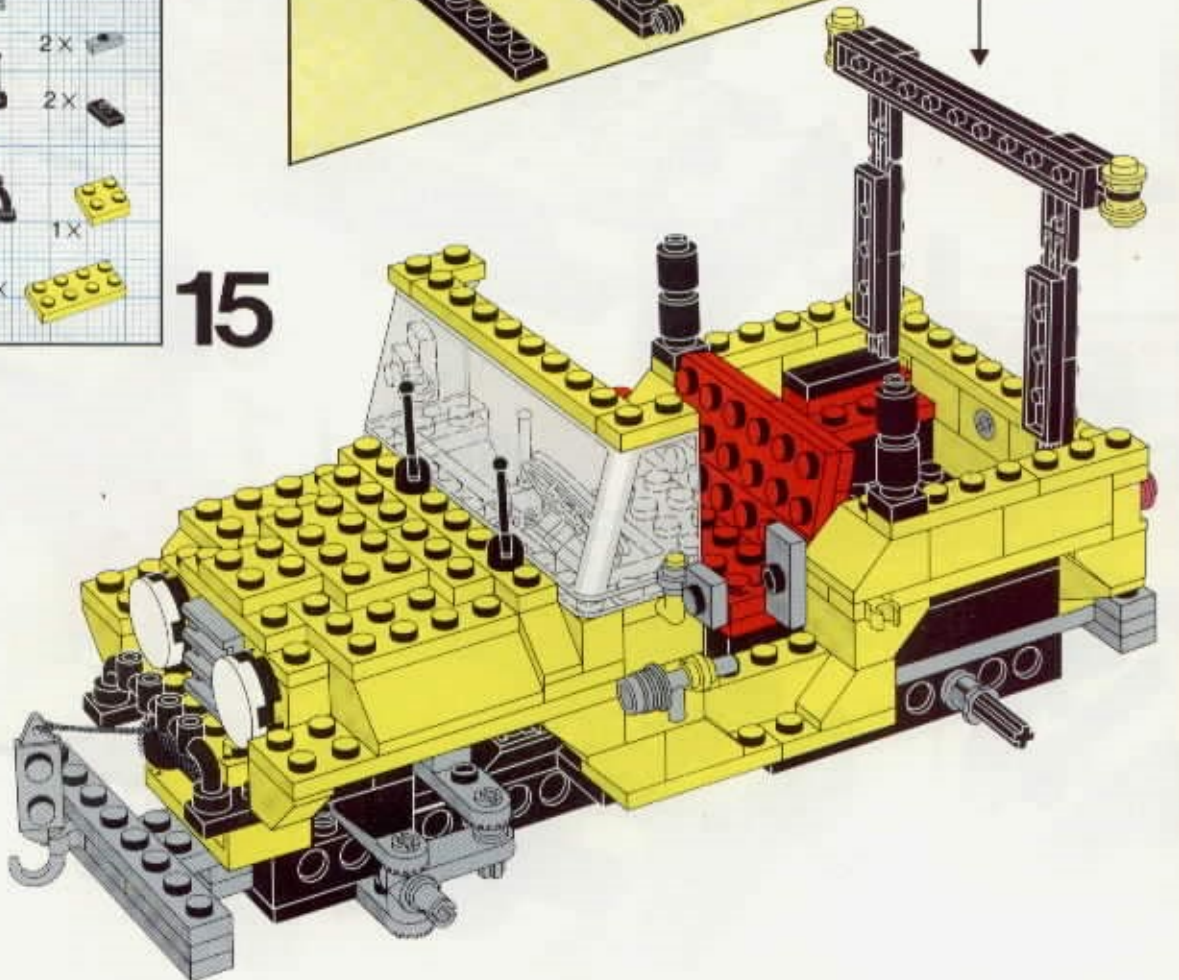



# 16

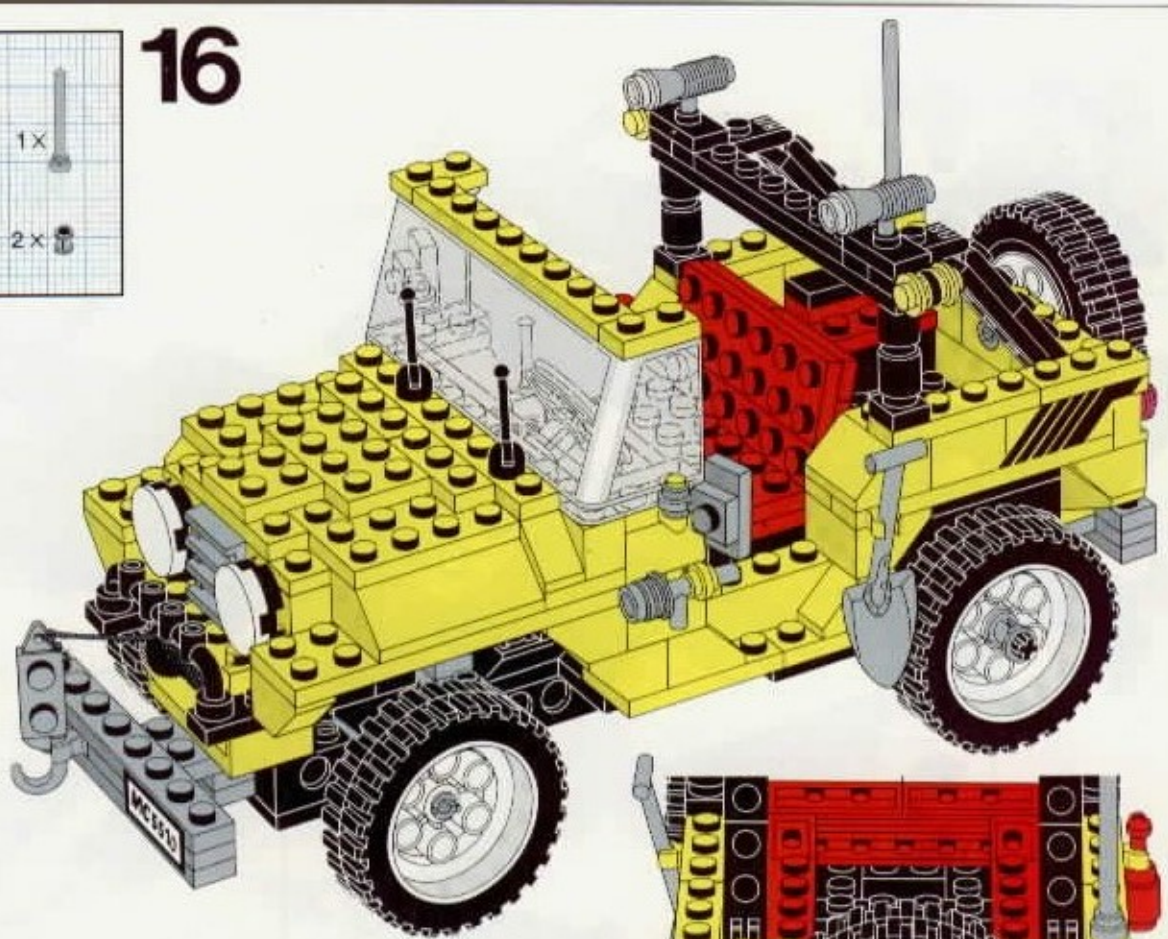
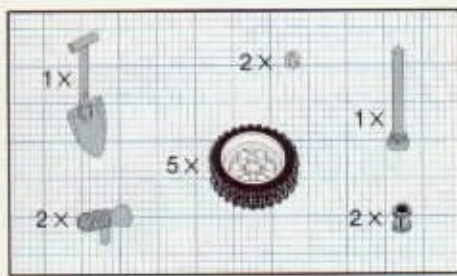

## 1

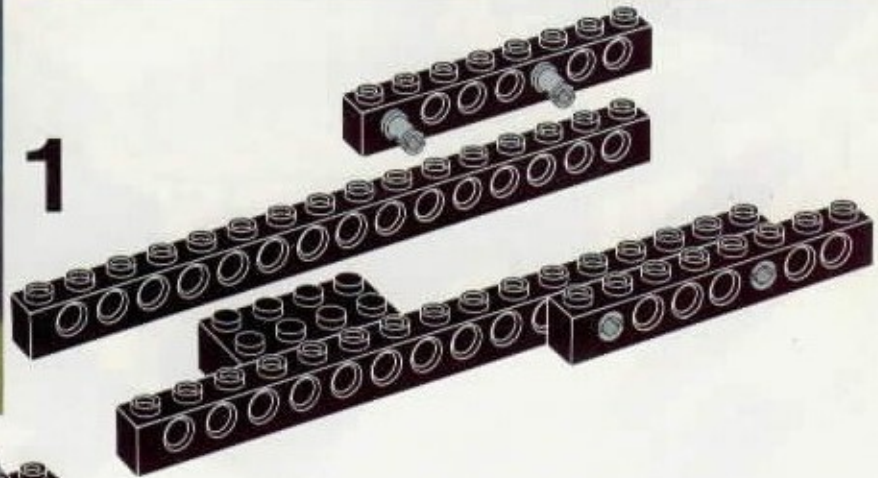

## 2

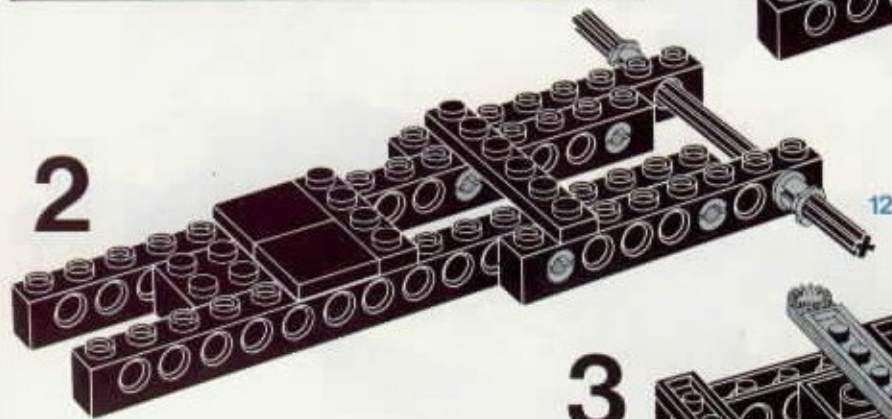

## 3





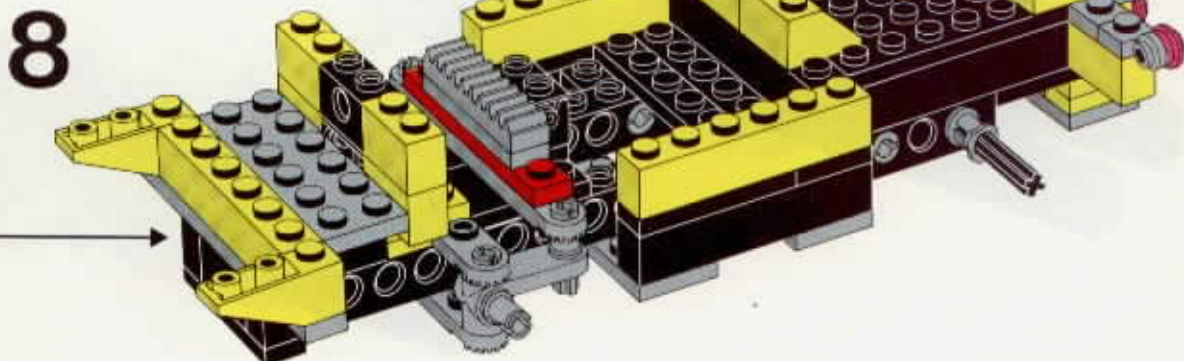
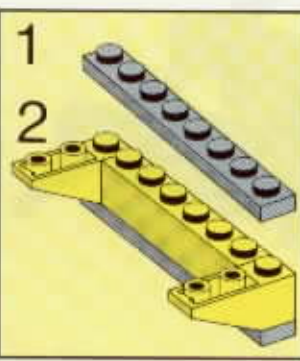
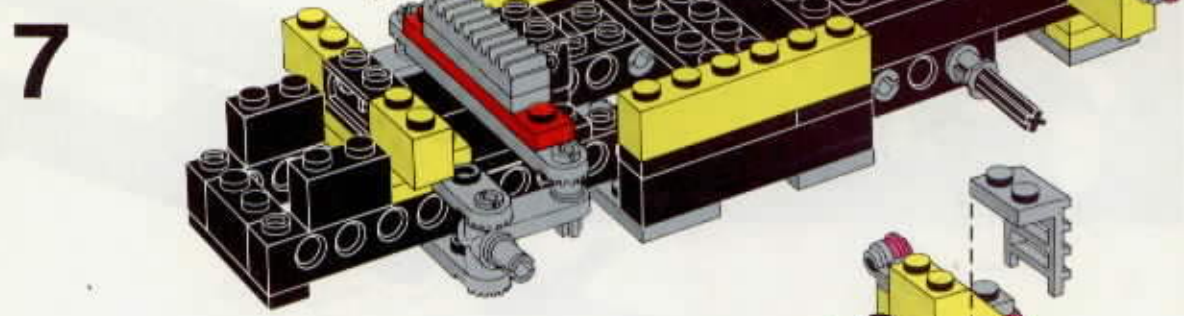
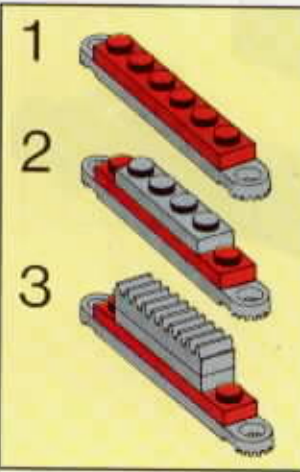
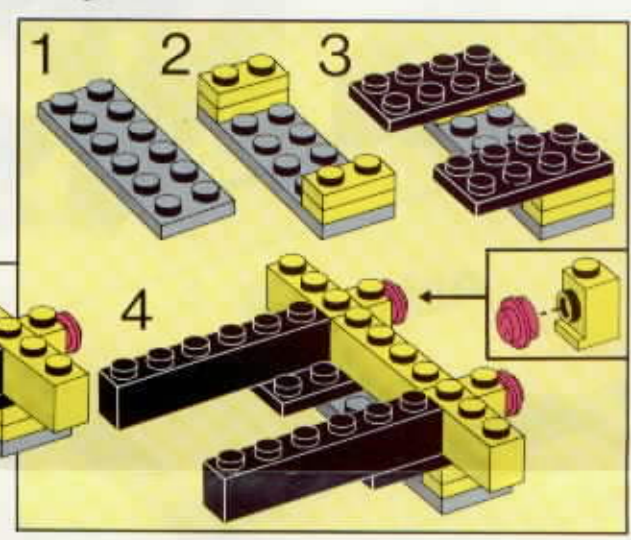
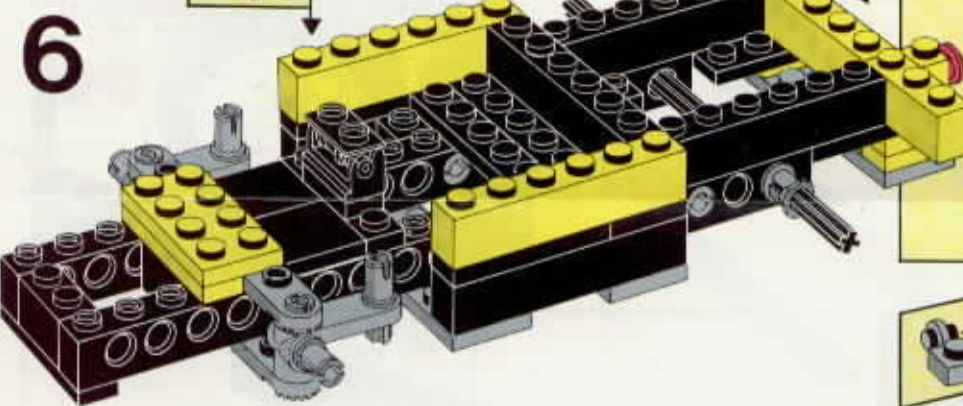
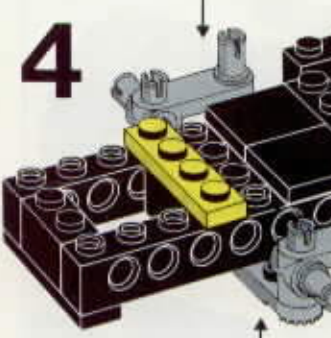
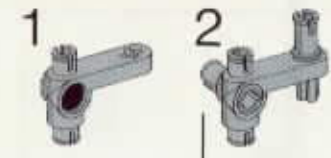



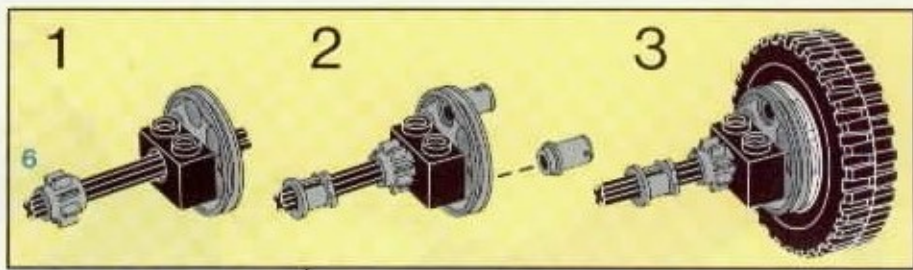
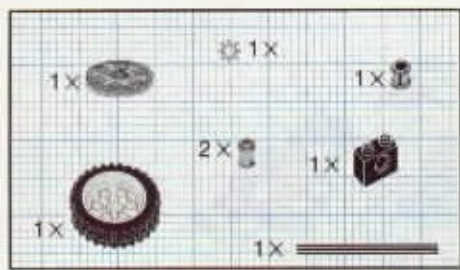

9

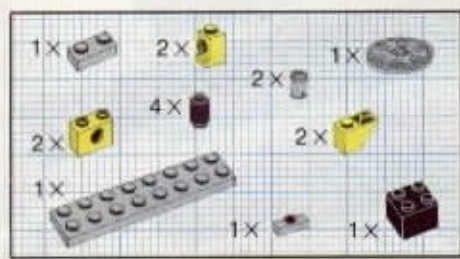
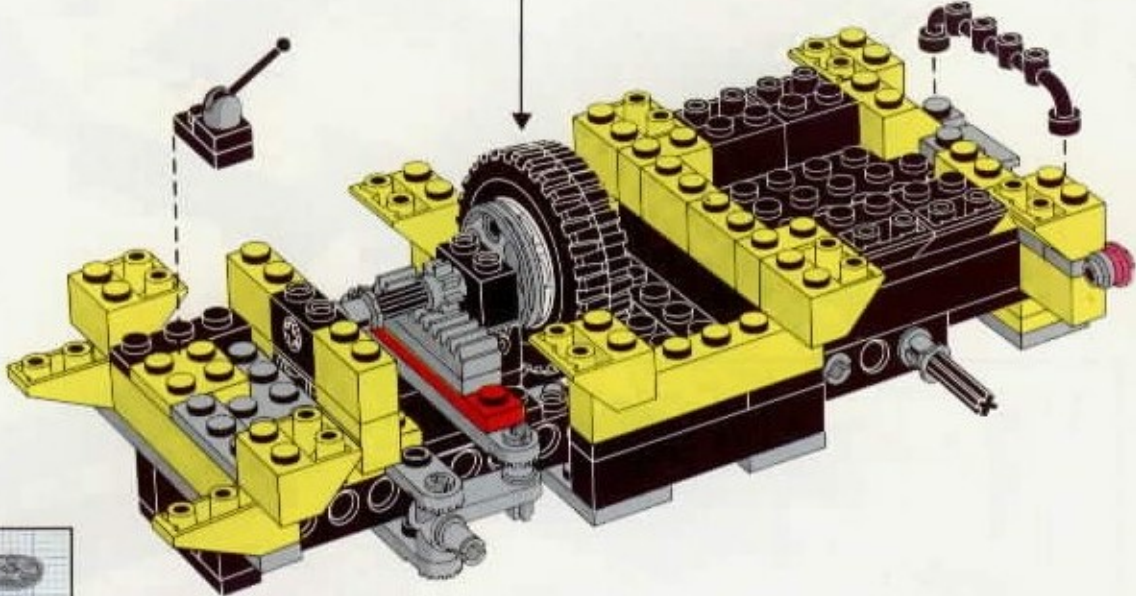

10

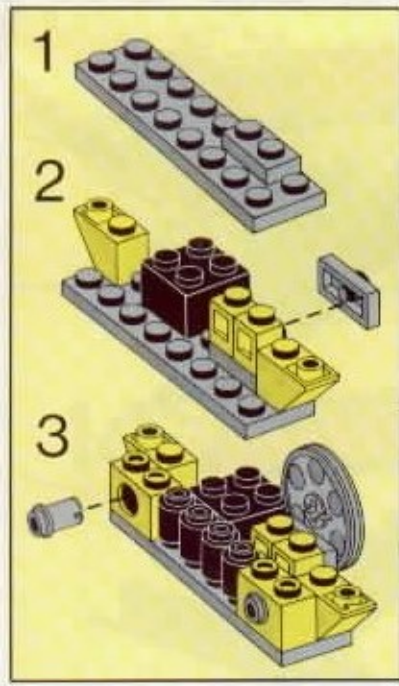
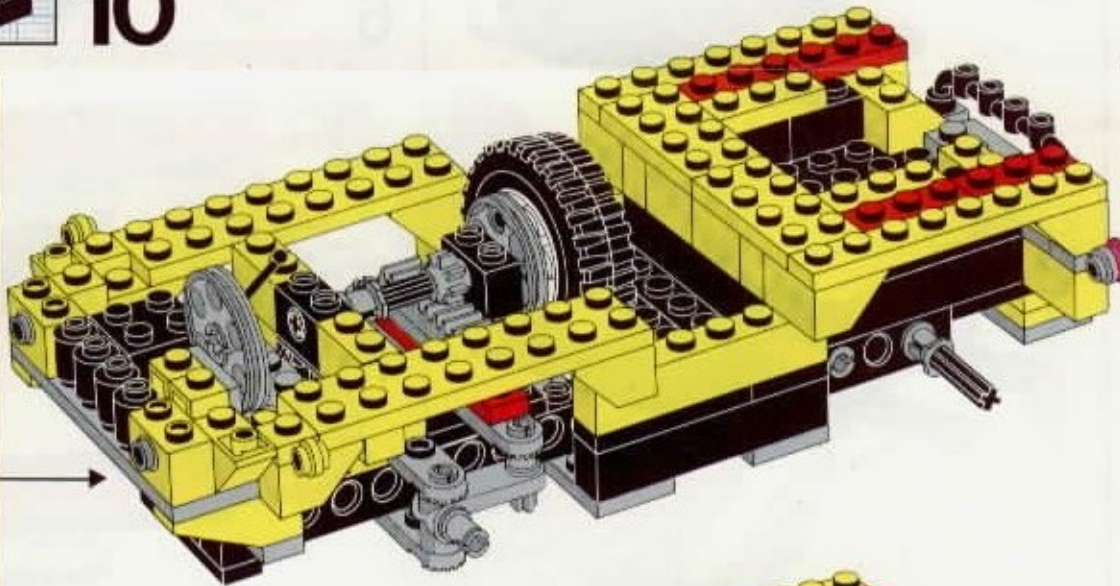

11

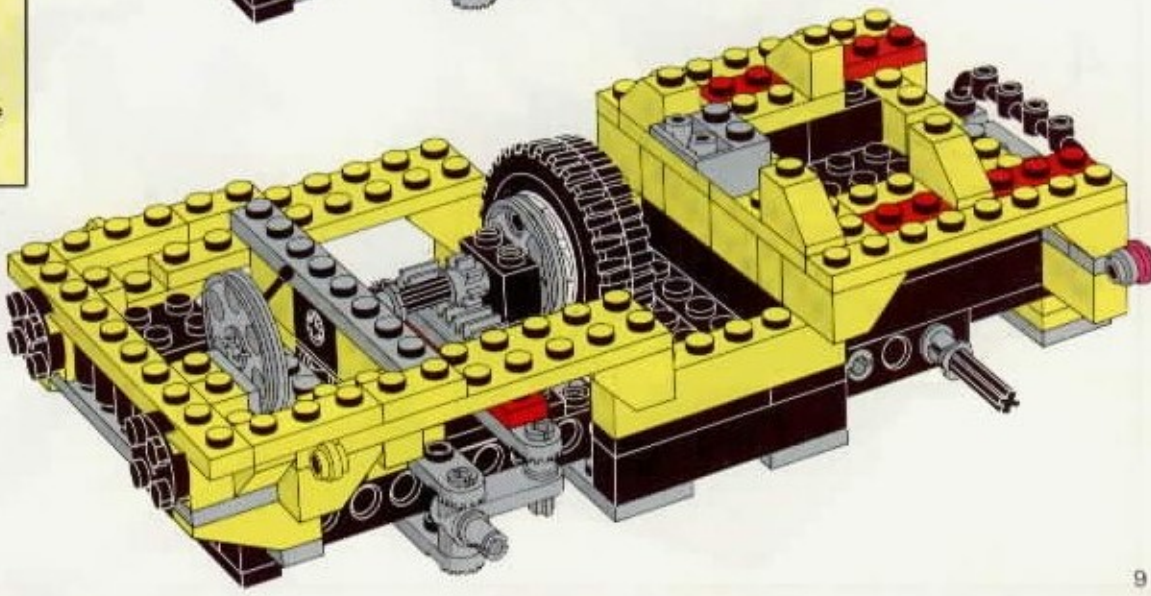



# 12

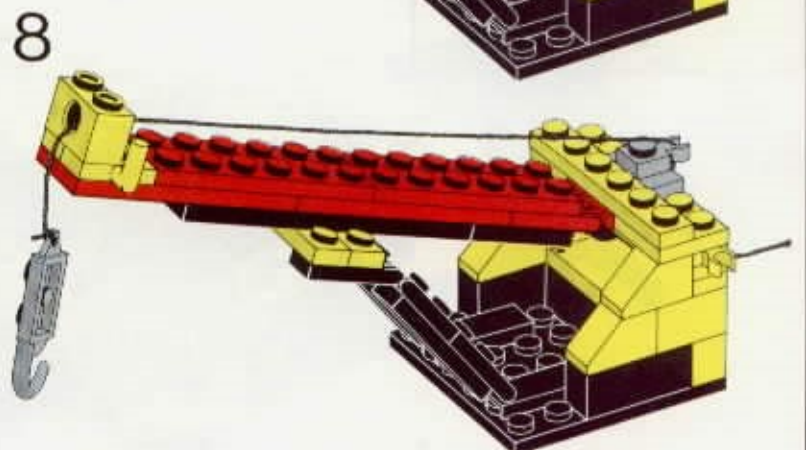
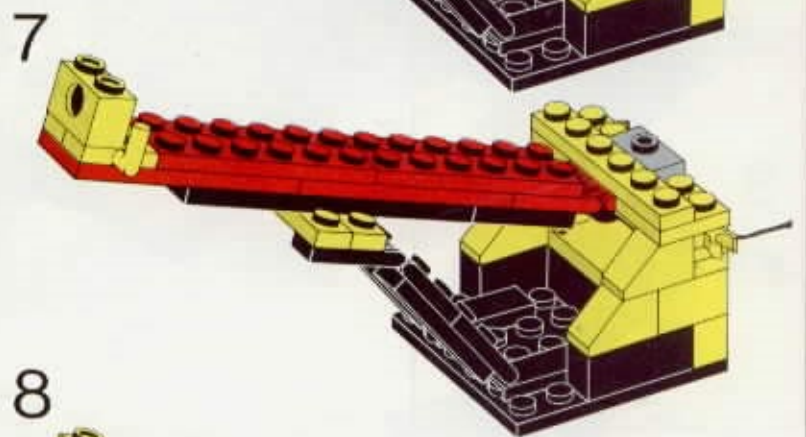
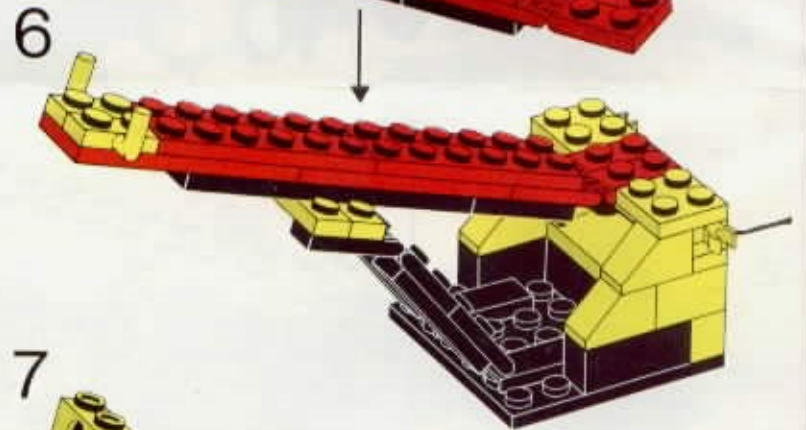
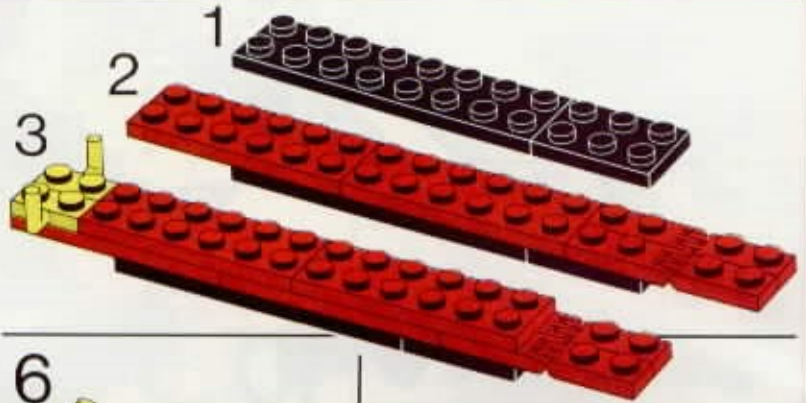
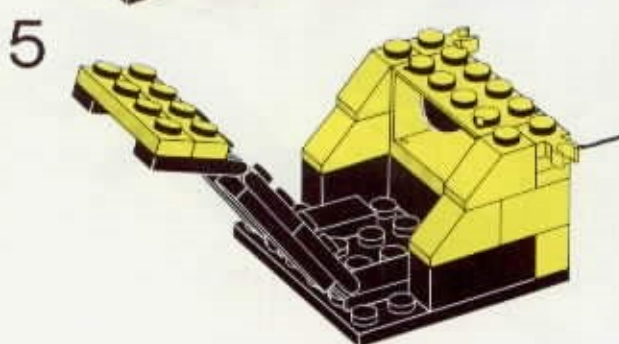
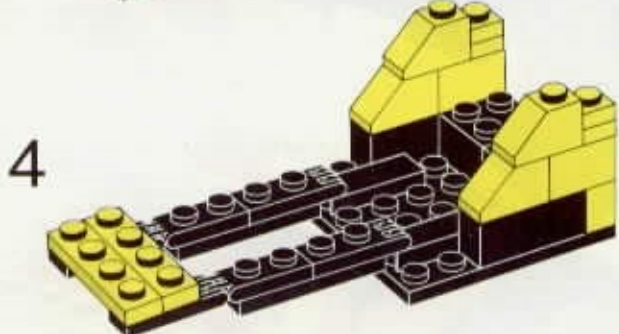
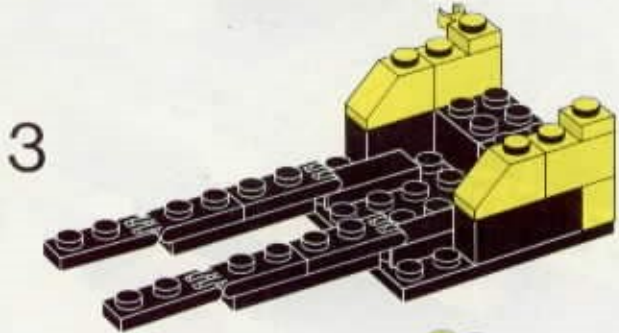
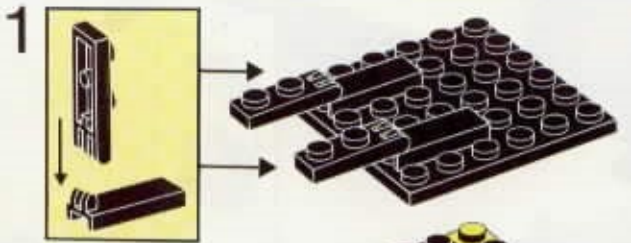
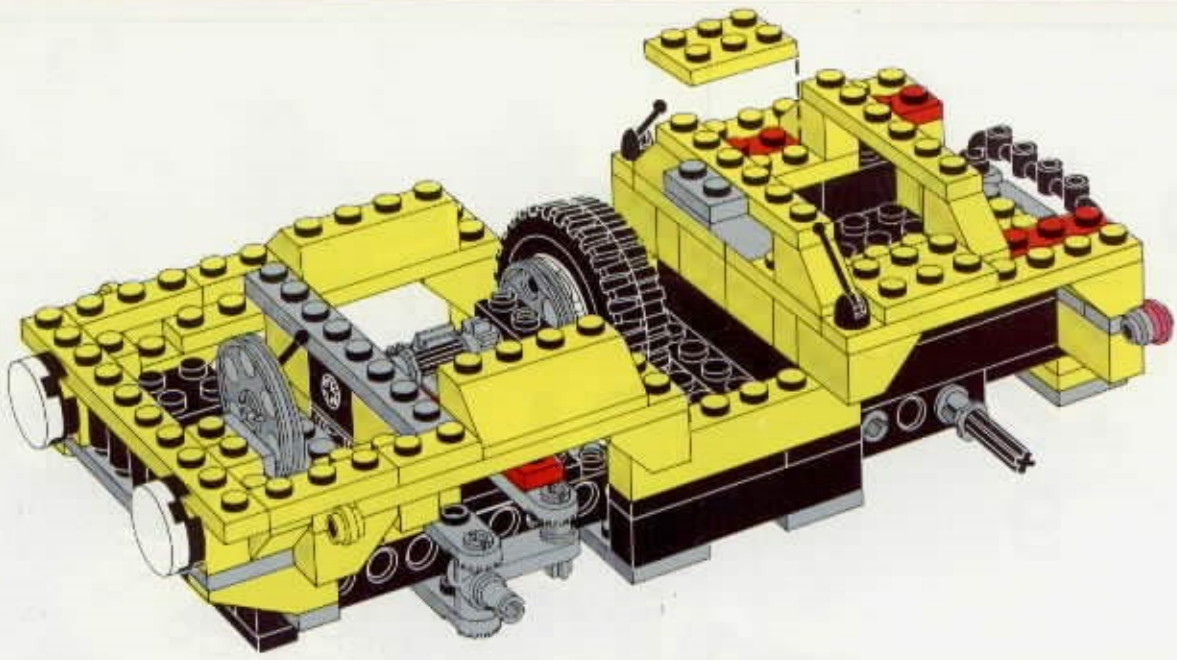



13

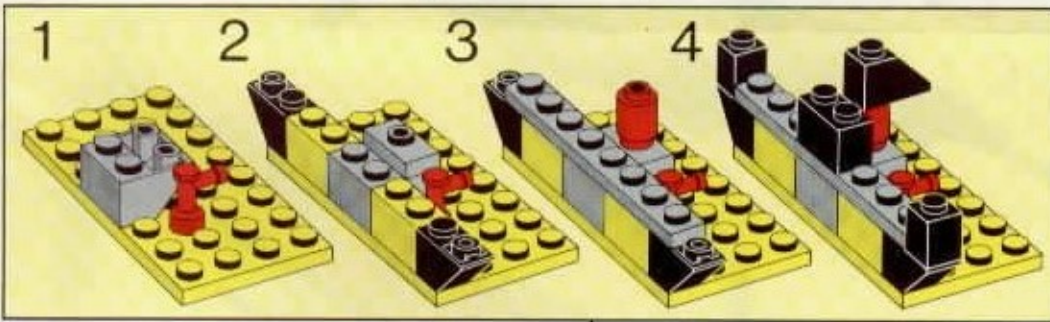

14

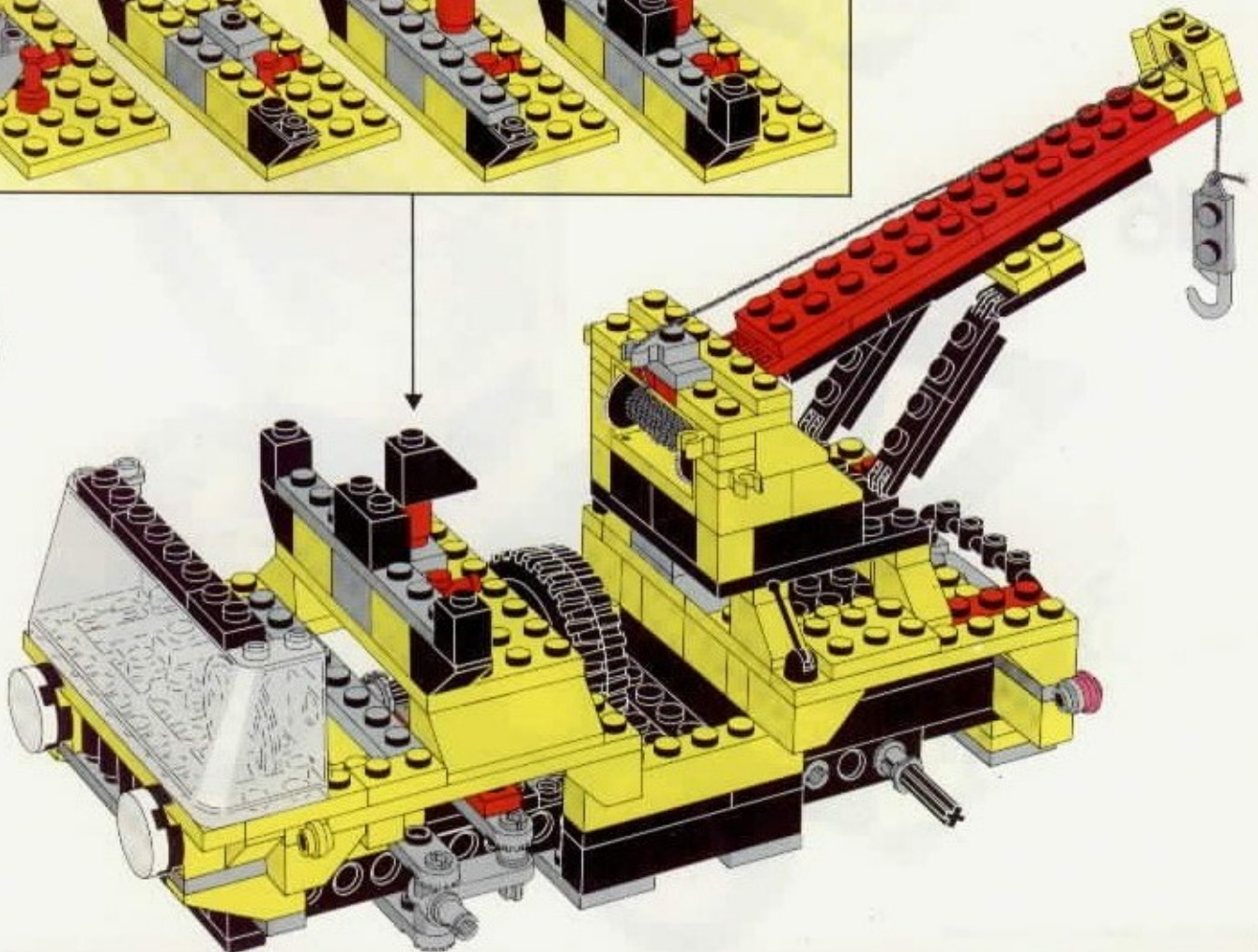



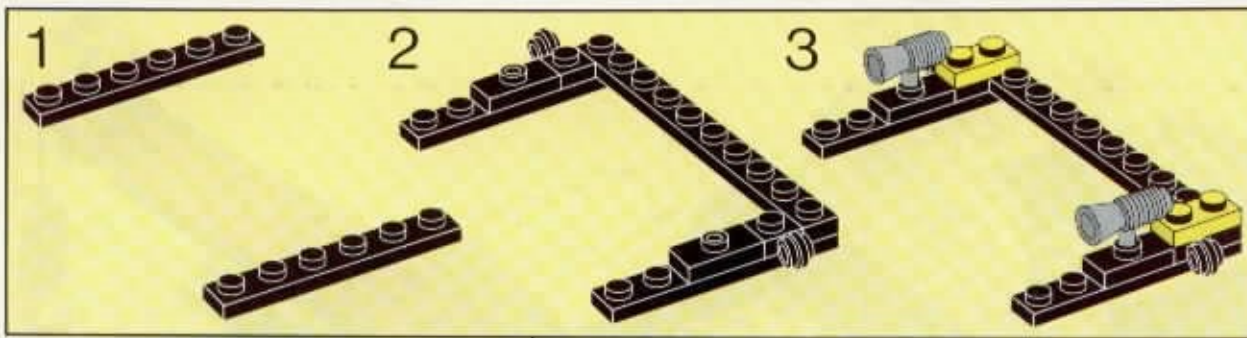

15

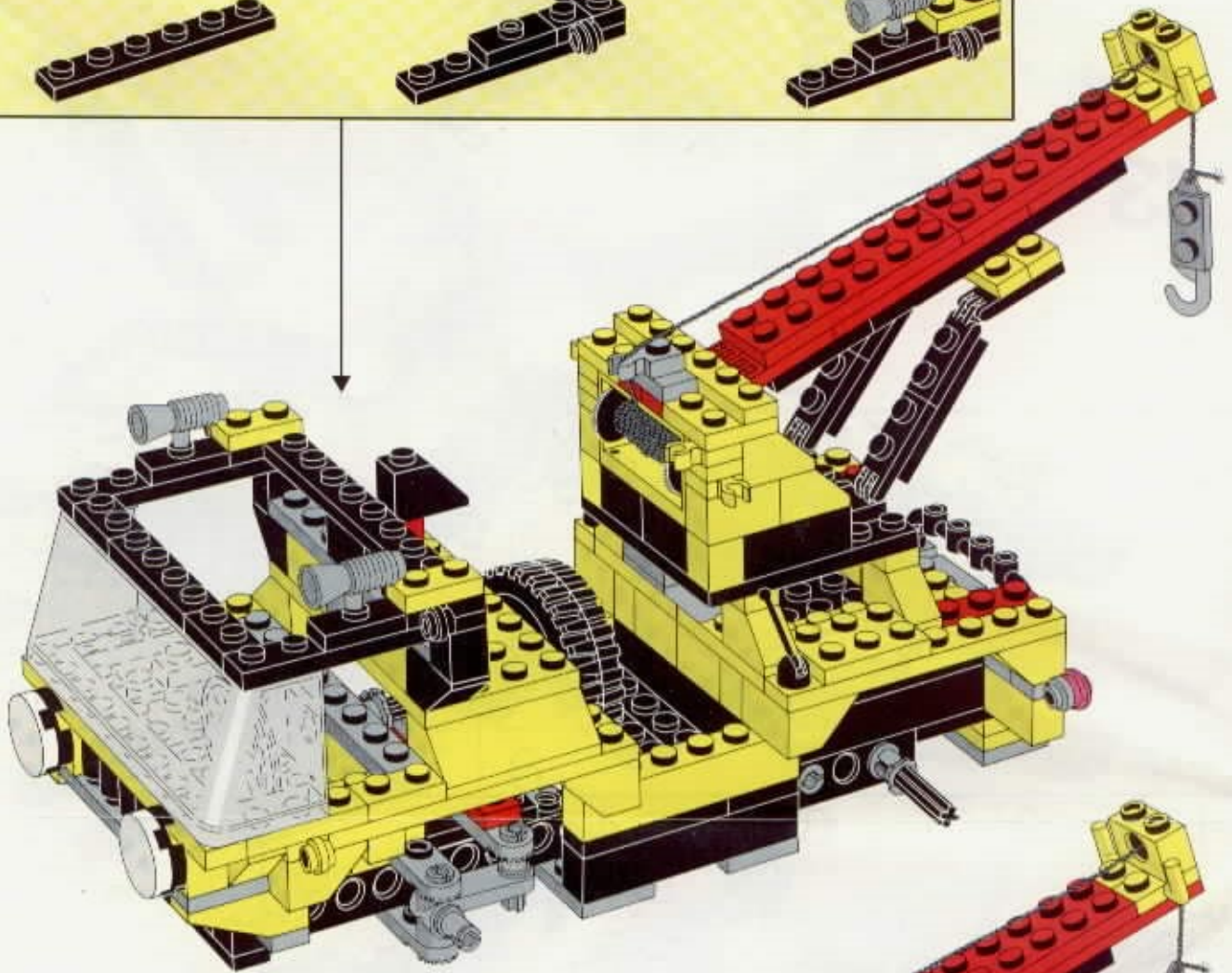

16





**MC 5510**

**MC 5510**















**MC  
5510**





**MC  
5510**



Image	Qty	Item No	Description	MID
<b>Regular Items:</b>				
<b>Parts:</b>				
 *	1	<a href="#">3957</a>	<b>Light Gray Antenna 1 x 4</b> <a href="#">Catalog:</a> <a href="#">Parts:</a> <a href="#">Antenna</a>	<a href="#">PG</a>
 *	1	<a href="#">4873</a>	<b>Black Bar 1 x 6 with Open Studs</b> <a href="#">Catalog:</a> <a href="#">Parts:</a> <a href="#">Bar</a>	<a href="#">PG</a> 1 
 *	2	<a href="#">3005</a>	<b>Black Brick 1 x 1</b> <a href="#">Catalog:</a> <a href="#">Parts:</a> <a href="#">Brick</a>	<a href="#">PG</a>
 *	2	<a href="#">3005</a>	<b>Yellow Brick 1 x 1</b> <a href="#">Catalog:</a> <a href="#">Parts:</a> <a href="#">Brick</a>	<a href="#">PG</a>
 *	4	<a href="#">3004</a>	<b>Black Brick 1 x 2</b> <a href="#">Catalog:</a> <a href="#">Parts:</a> <a href="#">Brick</a>	<a href="#">PG</a>
 *	10	<a href="#">3004</a>	<b>Yellow Brick 1 x 2</b> <a href="#">Catalog:</a> <a href="#">Parts:</a> <a href="#">Brick</a>	<a href="#">PG</a>
 *	2	<a href="#">3622</a>	<b>Black Brick 1 x 3</b> <a href="#">Catalog:</a> <a href="#">Parts:</a> <a href="#">Brick</a>	<a href="#">PG</a>
 *	2	<a href="#">3622</a>	<b>Yellow Brick 1 x 3</b> <a href="#">Catalog:</a> <a href="#">Parts:</a> <a href="#">Brick</a>	<a href="#">PG</a>
 *	1	<a href="#">3010</a>	<b>Yellow Brick 1 x 4</b> <a href="#">Catalog:</a> <a href="#">Parts:</a> <a href="#">Brick</a>	<a href="#">PG</a>
 *	5	<a href="#">3009</a>	<b>Black Brick 1 x 6</b> <a href="#">Catalog:</a> <a href="#">Parts:</a> <a href="#">Brick</a>	<a href="#">PG</a>
 *	3	<a href="#">3009</a>	<b>Yellow Brick 1 x 6</b> <a href="#">Catalog:</a> <a href="#">Parts:</a> <a href="#">Brick</a>	<a href="#">PG</a>





+	 *	3	<a href="#">3003old</a>	<b>Black Brick 2 x 2 without Inside Supports</b> <a href="#">Catalog:</a> <a href="#">Parts:</a> <a href="#">Brick</a>	<a href="#">PG</a>
---	---	---	-------------------------	---	--------------------

+	 *	1	<a href="#">3001</a>	<b>Black Brick 2 x 4</b> <a href="#">Catalog:</a> <a href="#">Parts:</a> <a href="#">Brick</a>	<a href="#">PG</a>
---	--	---	----------------------	---	--------------------

+	 *	4	<a href="#">4070</a>	<b>Yellow Brick, Modified 1 x 1 with Headlight</b> <a href="#">Catalog:</a> <a href="#">Parts:</a> <a href="#">Brick, Modified</a>	<a href="#">PG</a>
---	--	---	----------------------	---	--------------------



+	 *	4	<a href="#">3062b</a>	<b>Black Brick, Round 1 x 1 Open Stud</b> <a href="#">Catalog:</a> <a href="#">Parts:</a> <a href="#">Brick, Round</a>	<a href="#">PG</a>
---	--	---	-----------------------	---	--------------------

+	 *	1	<a href="#">3062b</a>	<b>Red Brick, Round 1 x 1 Open Stud</b> <a href="#">Catalog:</a> <a href="#">Parts:</a> <a href="#">Brick, Round</a>	<a href="#">PG</a>
---	--	---	-----------------------	---	--------------------



+	 *	1	<a href="#">x120a</a>	<b>Light Gray Fabuland Utensil Shovel with raised 'Fabuland'</b> <a href="#">Catalog:</a> <a href="#">Parts:</a> <a href="#">Fabuland</a>	<a href="#">PG</a>
---	---	---	-----------------------	--	--------------------

+	 *	3	<a href="#">3937</a>	<b>Black Hinge Brick 1 x 2 Base</b> <a href="#">Catalog:</a> <a href="#">Parts:</a> <a href="#">Hinge</a>	<a href="#">PG</a>
---	--	---	----------------------	--	--------------------

+	 *	3	<a href="#">3938</a>	<b>Black Hinge Brick 1 x 2 Top</b> <a href="#">Catalog:</a> <a href="#">Parts:</a> <a href="#">Hinge</a>	<a href="#">PG</a>
---	--	---	----------------------	---	--------------------

+	 *	2	<a href="#">4276a</a>	<b>Black Hinge Plate 1 x 2 with 2 Fingers and Solid Studs</b> <a href="#">Catalog:</a> <a href="#">Parts:</a> <a href="#">Hinge</a>	<a href="#">PG</a> 2 
---	--	---	-----------------------	--	--

+	 *	2	<a href="#">4276a</a>	<b>Red Hinge Plate 1 x 2 with 2 Fingers and Solid Studs</b> <a href="#">Catalog:</a> <a href="#">Parts:</a> <a href="#">Hinge</a>	<a href="#">PG</a> 3 
---	--	---	-----------------------	--	--

+	 *	4	<a href="#">4275a</a>	<b>Black Hinge Plate 1 x 2 with 3 Fingers and Solid Studs</b> <a href="#">Catalog:</a> <a href="#">Parts:</a> <a href="#">Hinge</a>	<a href="#">PG</a> 4 
---	--	---	-----------------------	--	--

+	 *	2	<a href="#">4275a</a>	<b>Red Hinge Plate 1 x 2 with 3 Fingers and Solid Studs</b> <a href="#">Catalog:</a> <a href="#">Parts:</a> <a href="#">Hinge</a>	<a href="#">PG</a> 5 
---	--	---	-----------------------	--	--



+



\*

2

[4531](#)

**Black Hinge Tile 1 x 2 1/2 with 2 Fingers on Top**

[Catalog:](#) [Parts:](#) [Hinge](#)

[PG](#)

+



\*

1

[3127](#)

**Light Gray Hook, Plate, Modified 1 x 2 with Crane Hook Left**

[Catalog:](#) [Parts:](#) [Hook](#)

[PG](#)

+



\*

2

[4592c02](#) (inv)

**Black Lever Small Base with Black Lever**

[Catalog:](#) [Parts:](#) [Lever](#)

[PG](#)

+



\*

1

[4592c02](#) (inv)

**Light Gray Lever Small Base with Black Lever**

[Catalog:](#) [Parts:](#) [Lever](#)

[PG](#)

+



\*

2

[4349](#)

**Light Gray Minifigure, Utensil Loudhailer / Megaphone / SW Blaster**

[Catalog:](#) [Parts:](#) [Minifigure, Utensil](#)

[PG](#)

+



\*

1

[3962a](#)

**Black Minifigure, Utensil Radio with Compact Handle**

[Catalog:](#) [Parts:](#) [Minifigure, Utensil](#)

[PG](#)

6

+



\*

2

[3959](#)

**Light Gray Minifigure, Utensil Space Gun / Torch**

[Catalog:](#) [Parts:](#) [Minifigure, Utensil](#)

[PG](#)

+



\*

3

[3024](#)

**Black Plate 1 x 1**

[Catalog:](#) [Parts:](#) [Plate](#)

[PG](#)

+



\*

2

[3024](#)

**Light Gray Plate 1 x 1**

[Catalog:](#) [Parts:](#) [Plate](#)

[PG](#)

+



\*

3

[3024](#)

**Yellow Plate 1 x 1**

[Catalog:](#) [Parts:](#) [Plate](#)

[PG](#)

+



\*

4

[3023](#)

**Black Plate 1 x 2**

[Catalog:](#) [Parts:](#) [Plate](#)

[PG](#)

+



\*

2

[3023](#)

**Light Gray Plate 1 x 2**

[Catalog:](#) [Parts:](#) [Plate](#)

[PG](#)



+		8	<a href="#">3023</a>	<b>Yellow Plate 1 x 2</b> <a href="#">Catalog:</a> <a href="#">Parts:</a> <a href="#">Plate</a>	<a href="#">PG</a>
---	--	---	----------------------	--	--------------------

\*

+		1	<a href="#">3623</a>	<b>Black Plate 1 x 3</b> <a href="#">Catalog:</a> <a href="#">Parts:</a> <a href="#">Plate</a>	<a href="#">PG</a>
---	---	---	----------------------	---	--------------------

\*

+		1	<a href="#">3623</a>	<b>Light Gray Plate 1 x 3</b> <a href="#">Catalog:</a> <a href="#">Parts:</a> <a href="#">Plate</a>	<a href="#">PG</a>
---	---	---	----------------------	--	--------------------

\*

+		4	<a href="#">3623</a>	<b>Red Plate 1 x 3</b> <a href="#">Catalog:</a> <a href="#">Parts:</a> <a href="#">Plate</a>	<a href="#">PG</a>
---	---	---	----------------------	---	--------------------

\*

+		4	<a href="#">3623</a>	<b>Yellow Plate 1 x 3</b> <a href="#">Catalog:</a> <a href="#">Parts:</a> <a href="#">Plate</a>	<a href="#">PG</a>
---	---	---	----------------------	--	--------------------

\*

+		7	<a href="#">3710</a>	<b>Black Plate 1 x 4</b> <a href="#">Catalog:</a> <a href="#">Parts:</a> <a href="#">Plate</a>	<a href="#">PG</a>
---	---	---	----------------------	---	--------------------

\*

+		1	<a href="#">3710</a>	<b>Light Gray Plate 1 x 4</b> <a href="#">Catalog:</a> <a href="#">Parts:</a> <a href="#">Plate</a>	<a href="#">PG</a>
---	---	---	----------------------	--	--------------------

\*

+		3	<a href="#">3710</a>	<b>Yellow Plate 1 x 4</b> <a href="#">Catalog:</a> <a href="#">Parts:</a> <a href="#">Plate</a>	<a href="#">PG</a>
---	---	---	----------------------	--	--------------------

\*

+		3	<a href="#">3666</a>	<b>Black Plate 1 x 6</b> <a href="#">Catalog:</a> <a href="#">Parts:</a> <a href="#">Plate</a>	<a href="#">PG</a>
---	---	---	----------------------	---	--------------------

\*

+		1	<a href="#">3666</a>	<b>Red Plate 1 x 6</b> <a href="#">Catalog:</a> <a href="#">Parts:</a> <a href="#">Plate</a>	<a href="#">PG</a>
---	---	---	----------------------	---	--------------------

\*

+		3	<a href="#">3666</a>	<b>Yellow Plate 1 x 6</b> <a href="#">Catalog:</a> <a href="#">Parts:</a> <a href="#">Plate</a>	<a href="#">PG</a>
---	---	---	----------------------	--	--------------------

\*

+		4	<a href="#">3460</a>	<b>Light Gray Plate 1 x 8</b> <a href="#">Catalog:</a> <a href="#">Parts:</a> <a href="#">Plate</a>	<a href="#">PG</a>
---	---	---	----------------------	--	--------------------

\*



+		2	<a href="#">3460</a>	<b>Yellow Plate 1 x 8</b> <a href="#">Catalog:</a> <a href="#">Parts:</a> <a href="#">Plate</a>	<a href="#">PG</a>
---	--	---	----------------------	--	--------------------

+		1	<a href="#">4477</a>	<b>Black Plate 1 x 10</b> <a href="#">Catalog:</a> <a href="#">Parts:</a> <a href="#">Plate</a>	<a href="#">PG</a>
---	---	---	----------------------	--	--------------------

+		1	<a href="#">4477</a>	<b>Yellow Plate 1 x 10</b> <a href="#">Catalog:</a> <a href="#">Parts:</a> <a href="#">Plate</a>	<a href="#">PG</a>
---	---	---	----------------------	---	--------------------

+		3	<a href="#">3022</a>	<b>Yellow Plate 2 x 2</b> <a href="#">Catalog:</a> <a href="#">Parts:</a> <a href="#">Plate</a>	<a href="#">PG</a>
---	---	---	----------------------	--	--------------------

+		1	<a href="#">3021</a>	<b>Black Plate 2 x 3</b> <a href="#">Catalog:</a> <a href="#">Parts:</a> <a href="#">Plate</a>	<a href="#">PG</a>
---	---	---	----------------------	---	--------------------

+		2	<a href="#">3021</a>	<b>Yellow Plate 2 x 3</b> <a href="#">Catalog:</a> <a href="#">Parts:</a> <a href="#">Plate</a>	<a href="#">PG</a>
---	---	---	----------------------	--	--------------------

+		3	<a href="#">3020</a>	<b>Black Plate 2 x 4</b> <a href="#">Catalog:</a> <a href="#">Parts:</a> <a href="#">Plate</a>	<a href="#">PG</a>
---	---	---	----------------------	---	--------------------

+		3	<a href="#">3020</a>	<b>Yellow Plate 2 x 4</b> <a href="#">Catalog:</a> <a href="#">Parts:</a> <a href="#">Plate</a>	<a href="#">PG</a>
---	---	---	----------------------	--	--------------------



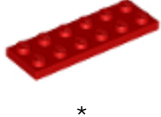













+		2	<a href="#">3795</a>	<b>Light Gray Plate 2 x 6</b> <a href="#">Catalog:</a> <a href="#">Parts:</a> <a href="#">Plate</a>	<a href="#">PG</a>
---	---	---	----------------------	--	--------------------

+		4	<a href="#">3795</a>	<b>Red Plate 2 x 6</b> <a href="#">Catalog:</a> <a href="#">Parts:</a> <a href="#">Plate</a>	<a href="#">PG</a>
---	---	---	----------------------	---	--------------------

+		2	<a href="#">3034</a>	<b>Black Plate 2 x 8</b> <a href="#">Catalog:</a> <a href="#">Parts:</a> <a href="#">Plate</a>	<a href="#">PG</a>
---	---	---	----------------------	---	--------------------

+		3	<a href="#">3034</a>	<b>Light Gray Plate 2 x 8</b> <a href="#">Catalog:</a> <a href="#">Parts:</a> <a href="#">Plate</a>	<a href="#">PG</a>
---	---	---	----------------------	--	--------------------



+		2	<a href="#">3034</a>	<b>Yellow Plate 2 x 8</b> <a href="#">Catalog: Parts: Plate</a>	<a href="#">PG</a>
	*				
+		1	<a href="#">3035</a>	<b>Yellow Plate 4 x 8</b> <a href="#">Catalog: Parts: Plate</a>	<a href="#">PG</a>
	*				
+		2	<a href="#">3958</a>	<b>Black Plate 6 x 6</b> <a href="#">Catalog: Parts: Plate</a>	<a href="#">PG</a>
	*				
+		2	<a href="#">4081a</a>	<b>Black Plate, Modified 1 x 1 with Clip Light - Thin Ring</b> <a href="#">Catalog: Parts: Plate. Modified</a>	<a href="#">PG</a>
	*				7 
+		2	<a href="#">4081a</a>	<b>Light Gray Plate, Modified 1 x 1 with Clip Light - Thin Ring</b> <a href="#">Catalog: Parts: Plate. Modified</a>	<a href="#">PG</a>
	*				8 
+		2	<a href="#">4081a</a>	<b>Yellow Plate, Modified 1 x 1 with Clip Light - Thin Ring</b> <a href="#">Catalog: Parts: Plate. Modified</a>	<a href="#">PG</a>
	*				9 
+		1	<a href="#">4085b</a>	<b>Light Gray Plate, Modified 1 x 1 with Clip Vertical - Type 2 (thin U clip)</b> <a href="#">Catalog: Parts: Plate. Modified</a>	<a href="#">PG</a>
	*				10 
+		3	<a href="#">4085b</a>	<b>Yellow Plate, Modified 1 x 1 with Clip Vertical - Type 2 (thin U clip)</b> <a href="#">Catalog: Parts: Plate. Modified</a>	<a href="#">PG</a>
	*				11 
+		2	<a href="#">3794a</a>	<b>Black Plate, Modified 1 x 2 with 1 Stud without Groove (Jumper)</b> <a href="#">Catalog: Parts: Plate. Modified</a>	<a href="#">PG</a>
	*				
+		3	<a href="#">3794a</a>	<b>Light Gray Plate, Modified 1 x 2 with 1 Stud without Groove (Jumper)</b> <a href="#">Catalog: Parts: Plate. Modified</a>	<a href="#">PG</a>
	*				
+		2	<a href="#">4623</a>	<b>Yellow Plate, Modified 1 x 2 with Arm Up (Horizontal Arm Length 6mm)</b> <a href="#">Catalog: Parts: Plate. Modified</a>	<a href="#">PG</a>
	*				
+		1	<a href="#">4175</a>	<b>Light Gray Plate, Modified 1 x 2 with Ladder</b> <a href="#">Catalog: Parts: Plate. Modified</a>	<a href="#">PG</a>
	*				



+  1 [4073c01](#) (inv) **Trans-Clear Plate, Round 1 x 1, 2 on Sprue**

[Catalog](#): [Parts](#): [Plate](#): [Round](#)

[PG](#)

\*

+  2 [4073c01](#) (inv) **Trans-Red Plate, Round 1 x 1, 2 on Sprue**

[Catalog](#): [Parts](#): [Plate](#): [Round](#)

[PG](#)

\*

+  2 [4073c01](#) (inv) **Trans-Yellow Plate, Round 1 x 1, 2 on Sprue**

[Catalog](#): [Parts](#): [Plate](#): [Round](#)

[PG](#)

\*

+  2 [4032](#) **Black Plate, Round 2 x 2 with Axle Hole**

[Catalog](#): [Parts](#): [Plate](#): [Round](#)

[PG](#)

\*

+  1 [3040](#) **Black Slope 45 2 x 1**

[Catalog](#): [Parts](#): [Slope](#)

[PG](#)

\*

+  8 [3040](#) **Yellow Slope 45 2 x 1**

[Catalog](#): [Parts](#): [Slope](#)

[PG](#)

\*

+  4 [3039](#) **Yellow Slope 45 2 x 2**

[Catalog](#): [Parts](#): [Slope](#)

[PG](#)

\*

+  2 [3037](#) **Yellow Slope 45 2 x 4**

[Catalog](#): [Parts](#): [Slope](#)

[PG](#)

\*

+  2 [4287](#) **Yellow Slope, Inverted 33 3 x 1**

[Catalog](#): [Parts](#): [Slope](#): [Inverted](#)

[PG](#)

\*

+  2 [3665](#) **Black Slope, Inverted 45 2 x 1**

[Catalog](#): [Parts](#): [Slope](#): [Inverted](#)

[PG](#)

\*

+  2 [3665](#) **Yellow Slope, Inverted 45 2 x 1**

[Catalog](#): [Parts](#): [Slope](#): [Inverted](#)

[PG](#)

\*

+  4 [3660](#) **Black Slope, Inverted 45 2 x 2**

[Catalog](#): [Parts](#): [Slope](#): [Inverted](#)

[PG](#)

\*





+		2	<a href="#">3660</a>	<b>Light Gray Slope, Inverted 45 2 x 2</b> <a href="#">Catalog:</a> <a href="#">Parts:</a> <a href="#">Slope, Inverted</a>	<a href="#">PG</a>
	*				

+		8	<a href="#">3660</a>	<b>Yellow Slope, Inverted 45 2 x 2</b> <a href="#">Catalog:</a> <a href="#">Parts:</a> <a href="#">Slope, Inverted</a>	<a href="#">PG</a>
	*				

+		1	<a href="#">5510stk01</a>	<b>Sticker for Set 5510 - (197905)</b> <a href="#">Catalog:</a> <a href="#">Parts:</a> <a href="#">Sticker</a>	<a href="#">PG</a>
	*				

+		1	<a href="#">4210</a>	<b>Black String Reel 2 x 4 x 2 Drum</b> <a href="#">Catalog:</a> <a href="#">Parts:</a> <a href="#">String Reel / Winch</a>	<a href="#">PG</a>
	*				

+		1	<a href="#">4209</a>	<b>Yellow String Reel 2 x 4 x 2 Holder</b> <a href="#">Catalog:</a> <a href="#">Parts:</a> <a href="#">String Reel / Winch</a>	<a href="#">PG</a>
	*				

+		1	<a href="#">x77ac75</a>	<b>Black String, Cord Thin 75cm</b> <a href="#">Catalog:</a> <a href="#">Parts:</a> <a href="#">String</a>	<a href="#">PG</a>
	*				

+		1	<a href="#">4599a</a>	<b>Red Tap 1 x 1 with Hole in Nozzle End</b> <a href="#">Catalog:</a> <a href="#">Parts:</a> <a href="#">Tap</a>	<a href="#">PG</a>
	*				

+		5	<a href="#">3713</a>	<b>Light Gray Technic Bush</b> <a href="#">Catalog:</a> <a href="#">Parts:</a> <a href="#">Technic</a>	<a href="#">PG</a>
	*				













+		2	<a href="#">4185</a>	<b>Light Gray Technic Wedge Belt Wheel (Pulley)</b> <a href="#">Catalog:</a> <a href="#">Parts:</a> <a href="#">Technic</a>	<a href="#">PG</a>
	*				

+		1	<a href="#">3706</a>	<b>Black Technic, Axle 6</b> <a href="#">Catalog:</a> <a href="#">Parts:</a> <a href="#">Technic, Axle</a>	<a href="#">PG</a>
	*				

+		1	<a href="#">3708</a>	<b>Black Technic, Axle 12</b> <a href="#">Catalog:</a> <a href="#">Parts:</a> <a href="#">Technic, Axle</a>	<a href="#">PG</a>
	*				

+		2	<a href="#">3749</a>	<b>Light Gray Technic, Axle Pin without Friction Ridges Lengthwise</b> <a href="#">Catalog:</a> <a href="#">Parts:</a> <a href="#">Technic, Axle</a>	<a href="#">PG</a>
	*				





+	 *	2	<a href="#">3700</a>	<b>Black Technic, Brick 1 x 2 with Hole</b> <a href="#">Catalog:</a> <a href="#">Parts:</a> <a href="#">Technic, Brick</a>	<a href="#">PG</a>
+	 *	3	<a href="#">3700</a>	<b>Yellow Technic, Brick 1 x 2 with Hole</b> <a href="#">Catalog:</a> <a href="#">Parts:</a> <a href="#">Technic, Brick</a>	<a href="#">PG</a>
+	 *	1	<a href="#">3894</a>	<b>Black Technic, Brick 1 x 6 with Holes</b> <a href="#">Catalog:</a> <a href="#">Parts:</a> <a href="#">Technic, Brick</a>	<a href="#">PG</a>
+	 *	2	<a href="#">3702</a>	<b>Black Technic, Brick 1 x 8 with Holes</b> <a href="#">Catalog:</a> <a href="#">Parts:</a> <a href="#">Technic, Brick</a>	<a href="#">PG</a>
+	 *	2	<a href="#">3703</a>	<b>Black Technic, Brick 1 x 16 with Holes</b> <a href="#">Catalog:</a> <a href="#">Parts:</a> <a href="#">Technic, Brick</a>	<a href="#">PG</a>
+	 *	1	<a href="#">3647</a>	<b>Light Gray Technic, Gear 8 Tooth Type 1</b> <a href="#">Catalog:</a> <a href="#">Parts:</a> <a href="#">Technic, Gear</a>	<a href="#">PG</a>
+	 *	1	<a href="#">4019</a>	<b>Light Gray Technic, Gear 16 Tooth (First Version - 4 Round Holes)</b> <a href="#">Catalog:</a> <a href="#">Parts:</a> <a href="#">Technic, Gear</a>	<a href="#">PG</a>
+	 *	1	<a href="#">3743</a>	<b>Light Gray Technic, Gear Rack 1 x 4</b> <a href="#">Catalog:</a> <a href="#">Parts:</a> <a href="#">Technic, Gear</a>	<a href="#">PG</a>
+	 *	4	<a href="#">4274</a>	<b>Light Gray Technic, Pin 1/2</b> <a href="#">Catalog:</a> <a href="#">Parts:</a> <a href="#">Technic, Pin</a>	<a href="#">PG</a>
+	 *	7	<a href="#">3673</a>	<b>Light Gray Technic, Pin without Friction Ridges Lengthwise</b> <a href="#">Catalog:</a> <a href="#">Parts:</a> <a href="#">Technic, Pin</a>	<a href="#">PG</a>
+	 *	3	<a href="#">4442</a>	<b>Light Gray Technic, Plate 1 x 8 with Toothed Ends</b> <a href="#">Catalog:</a> <a href="#">Parts:</a> <a href="#">Technic, Plate</a>	<a href="#">PG</a>
+	 *	2	<a href="#">4261</a>	<b>Light Gray Technic, Steering Arm</b> <a href="#">Catalog:</a> <a href="#">Parts:</a> <a href="#">Technic, Steering</a>	<a href="#">PG</a>

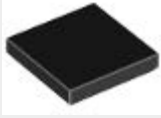

+		2	<a href="#">3068b</a>	<b>Black Tile 2 x 2 with Groove</b> <a href="#">Catalog:</a> <a href="#">Parts:</a> <a href="#">Tile</a>	<a href="#">PG</a>
---	--	---	-----------------------	---	--------------------

+		2	<a href="#">4150</a>	<b>White Tile, Round 2 x 2</b> <a href="#">Catalog:</a> <a href="#">Parts:</a> <a href="#">Tile, Round</a>	<a href="#">PG</a>
---	---	---	----------------------	---	--------------------

+		5	<a href="#">2695c01</a> (inv)	<b>White Wheel 30mm D. x 13mm (13 x 24 Model Team), with Black Tire 13 x 24 Model Team (2695 / 2696)</b> <a href="#">Catalog:</a> <a href="#">Parts:</a> <a href="#">Wheel &amp; Tire Assembly</a>	<a href="#">PG</a>
---	---	---	-------------------------------	---	--------------------

+		1	<a href="#">2694</a>	<b>Trans-Clear Windscreen 3 x 10 x 3</b> <a href="#">Catalog:</a> <a href="#">Parts:</a> <a href="#">Windscreen</a>	<a href="#">PG</a>
---	---	---	----------------------	--	--------------------

**Extra Items:**



+		1	<a href="#">4274</a>	<b>Light Gray Technic, Pin 1/2</b> <a href="#">Catalog:</a> <a href="#">Parts:</a> <a href="#">Technic, Pin</a>	<a href="#">PG</a>
---	---	---	----------------------	--	--------------------

**Counterparts:**

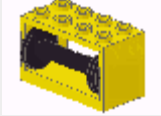
+		3	<a href="#">3937c01</a> (inv)	<b>Black Hinge Brick 1 x 2 Base with Same Color Hinge Brick 1 x 2 Top (3937 / 3938)</b> <a href="#">Catalog:</a> <a href="#">Parts:</a> <a href="#">Hinge</a>	<a href="#">PG</a>
---	--	---	-------------------------------	--	--------------------



+		1	<a href="#">4209c01</a> (inv)	<b>Yellow String Reel 2 x 4 x 2 Complete</b> <a href="#">Catalog:</a> <a href="#">Parts:</a> <a href="#">String Reel / Winch</a>	<a href="#">PG</a>
---	---	---	-------------------------------	---	--------------------













**Alternate Items:**

+		1	<a href="#">6140</a>	<b>Black Bar 1 x 6 with Hollow Studs</b> <a href="#">Catalog:</a> <a href="#">Parts:</a> <a href="#">Bar</a>	<a href="#">PG</a> 1 
---	---	---	----------------------	---	--

+		2	<a href="#">4276</a>	<b>Black Hinge Plate 1 x 2 with 2 Fingers</b> <a href="#">Catalog:</a> <a href="#">Parts:</a> <a href="#">Hinge</a>	<a href="#">PG</a> 2 
---	---	---	----------------------	--	--

+		2	<a href="#">4276</a>	<b>Red Hinge Plate 1 x 2 with 2 Fingers</b> <a href="#">Catalog:</a> <a href="#">Parts:</a> <a href="#">Hinge</a>	<a href="#">PG</a> 3 
---	---	---	----------------------	--	--

+		4	<a href="#">4275</a>	<b>Black Hinge Plate 1 x 2 with 3 Fingers</b> <a href="#">Catalog:</a> <a href="#">Parts:</a> <a href="#">Hinge</a>	<a href="#">PG</a> 4 
---	---	---	----------------------	--	--

- +  2 [4275](#) **Red Hinge Plate 1 x 2 with 3 Fingers** [PG](#) 5   
[Catalog:](#) [Parts:](#) [Hinge](#)
- +  1 [3962b](#) **Black Minifigure, Utensil Radio with Extended Handle** [PG](#) 6   
[Catalog:](#) [Parts:](#) [Minifigure](#), [Utensil](#)
- +  2 [4081b](#) **Black Plate, Modified 1 x 1 with Clip Light - Thick Ring** [PG](#) 7   
[Catalog:](#) [Parts:](#) [Plate](#), [Modified](#)
- +  2 [4081b](#) **Light Gray Plate, Modified 1 x 1 with Clip Light - Thick Ring** [PG](#) 8   
[Catalog:](#) [Parts:](#) [Plate](#), [Modified](#)
- +  2 [4081b](#) **Yellow Plate, Modified 1 x 1 with Clip Light - Thick Ring** [PG](#) 9   
[Catalog:](#) [Parts:](#) [Plate](#), [Modified](#)
- +  1 [4085c](#) **Light Gray Plate, Modified 1 x 1 with Clip Vertical - Type 3 (thick U clip)** [PG](#) 10   
[Catalog:](#) [Parts:](#) [Plate](#), [Modified](#)
- +  3 [4085c](#) **Yellow Plate, Modified 1 x 1 with Clip Vertical - Type 3 (thick U clip)** [PG](#) 11   
[Catalog:](#) [Parts:](#) [Plate](#), [Modified](#)

**Summary:**

Type	Unique Lots	Total Qty
<b>Regular Items:</b>		
Parts	111	275
<b>Extra Items:</b>		
Parts	1	1
<b>Counterparts:</b>		
Parts	2	4
<b>Alternative Items:</b>		
Parts	11	22

[RubenRas \(538\)](#)  inventoried this Set on Aug 28, 2006, inventory last updated on Jan 7, 2019.