

LEGO SYSTEM™

**MODEL
TEAM**

2556



F1 Ferrari



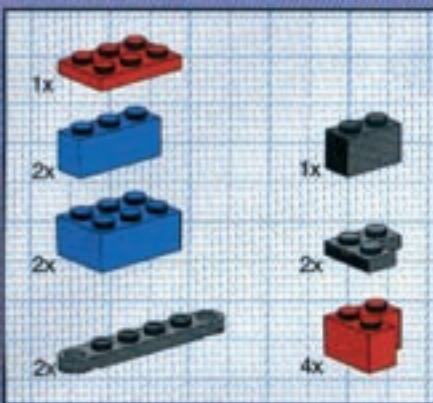

9

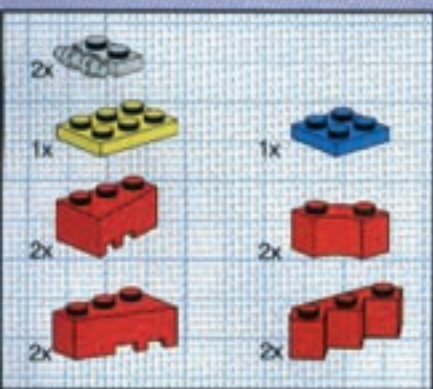
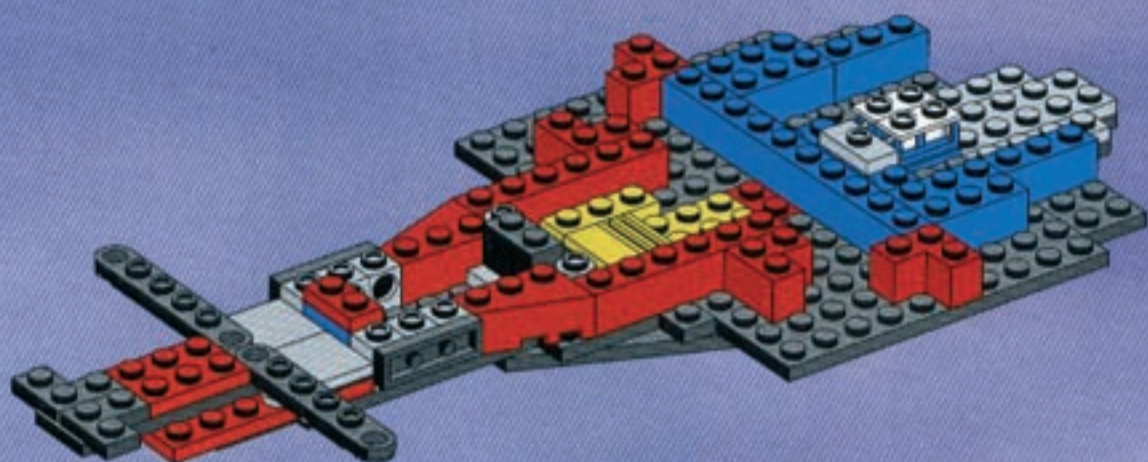

10

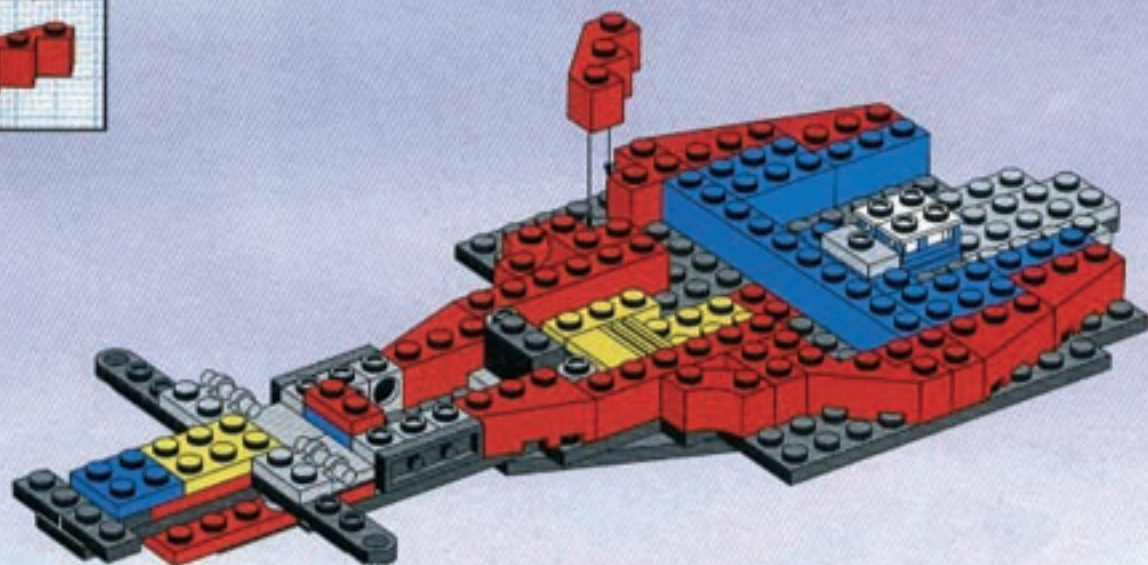

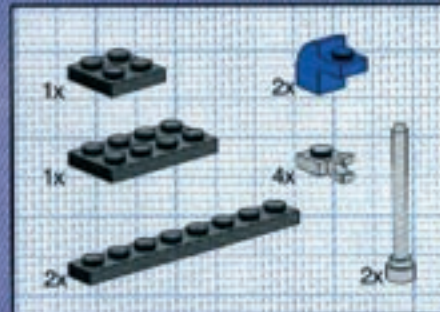
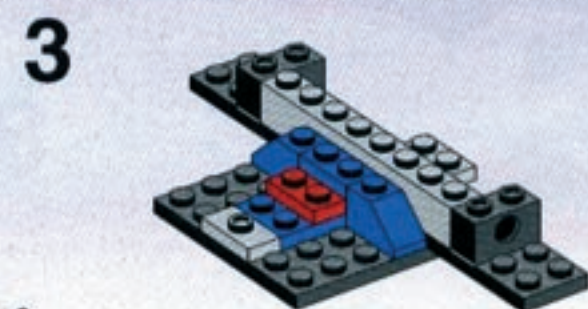
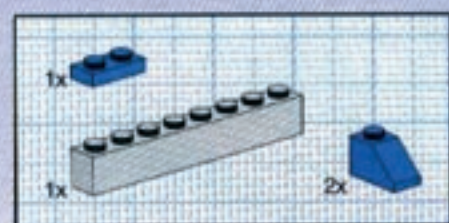
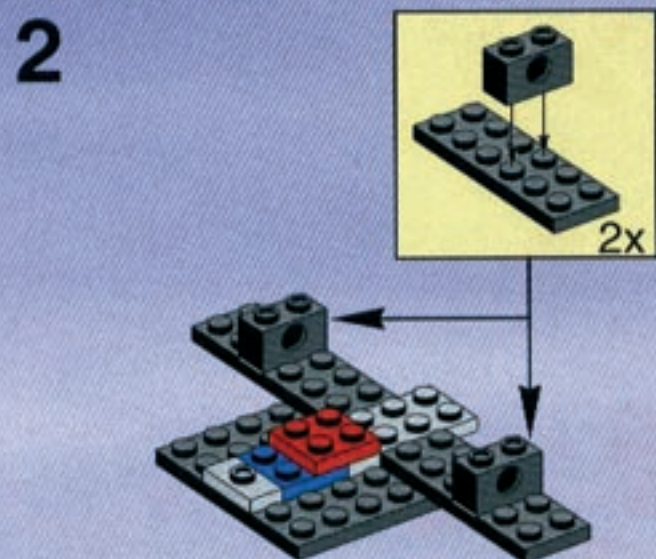
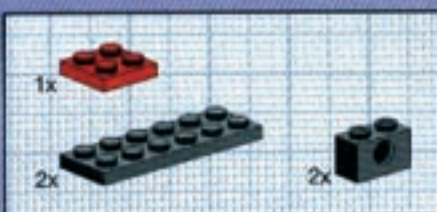
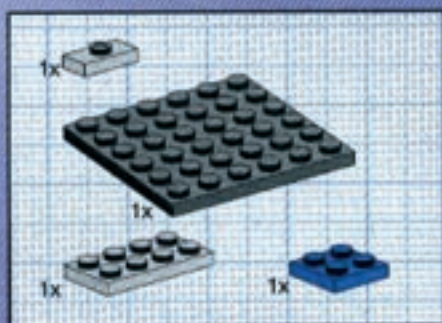

4

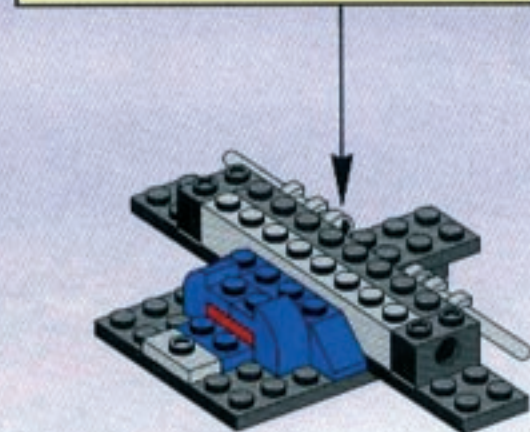
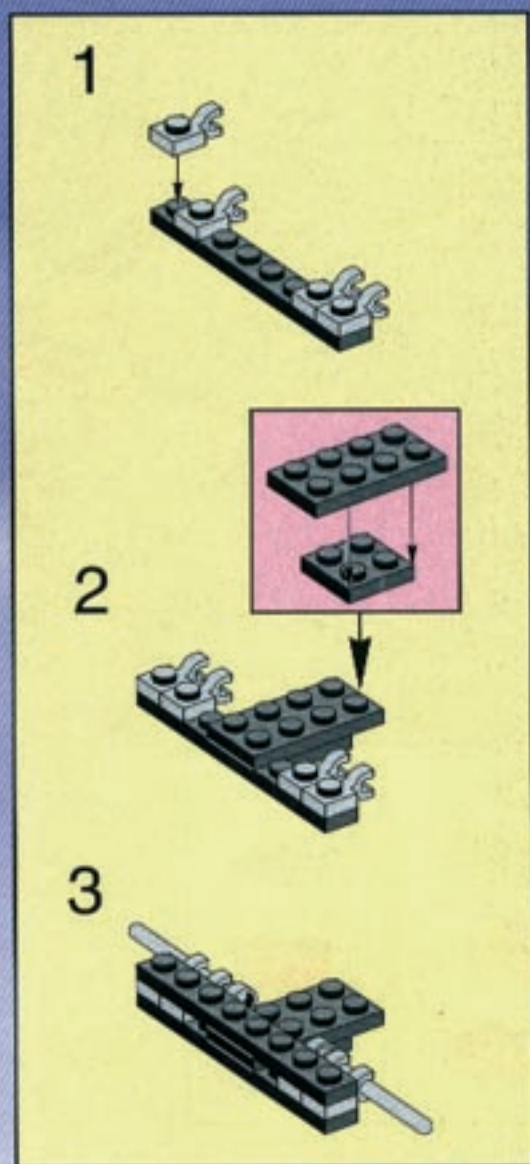

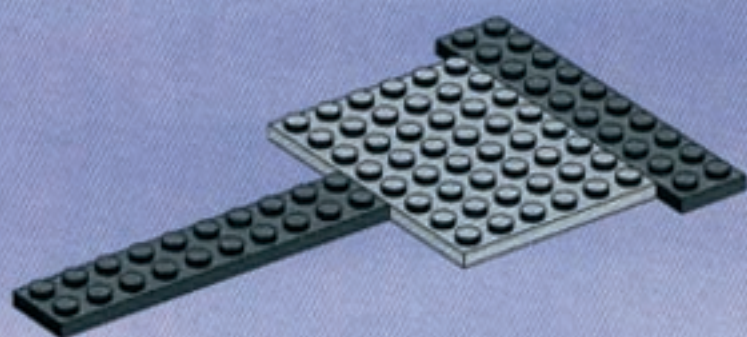
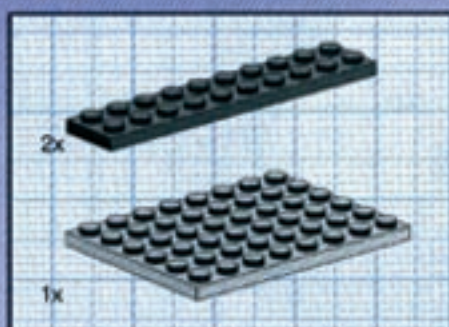
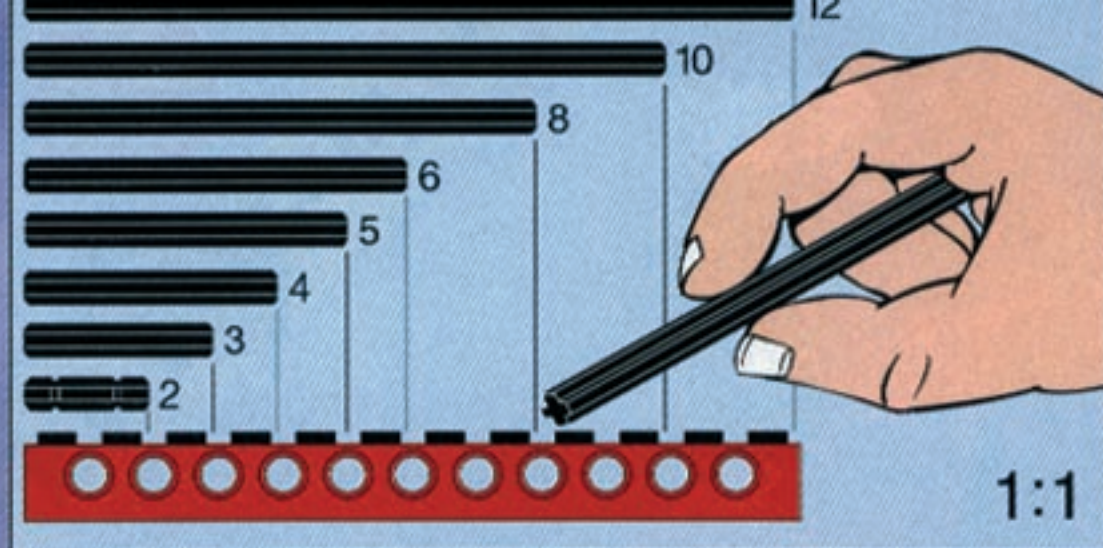

1

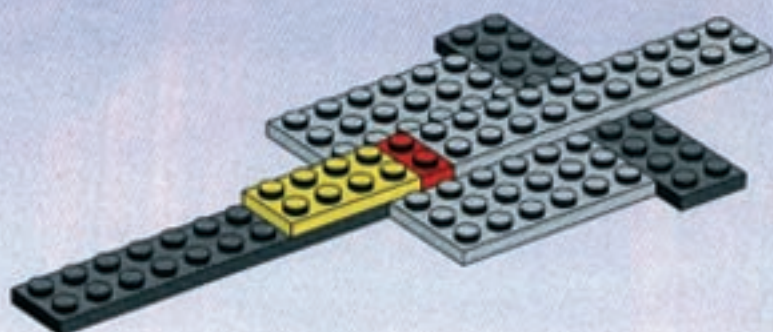
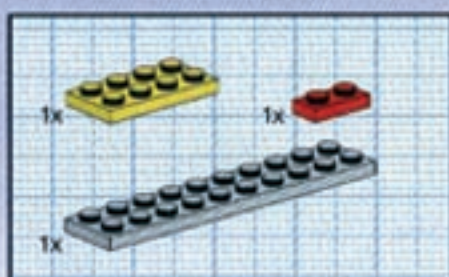

2



3

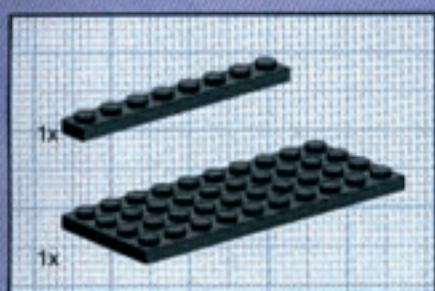
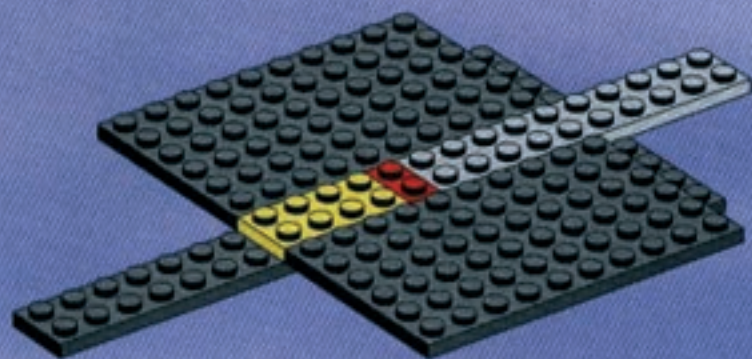

4

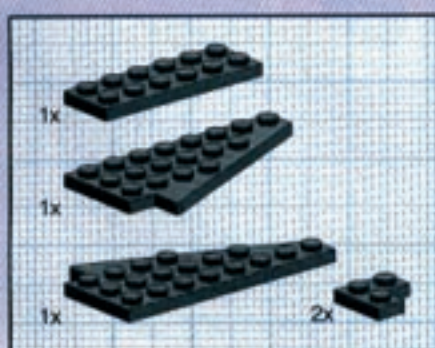
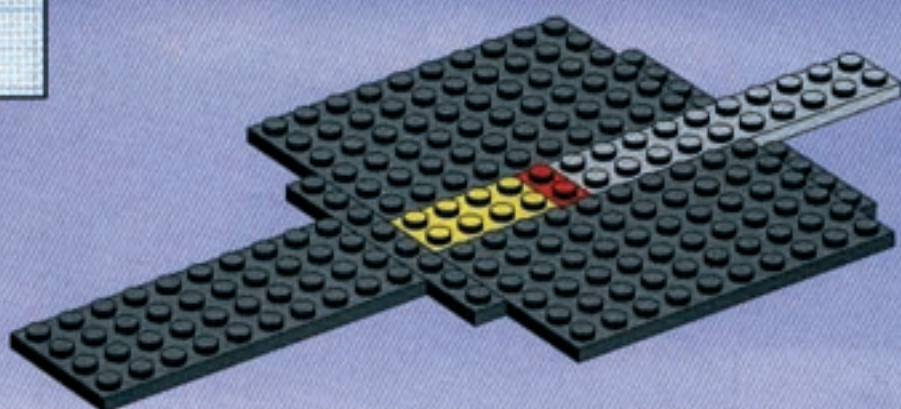

5

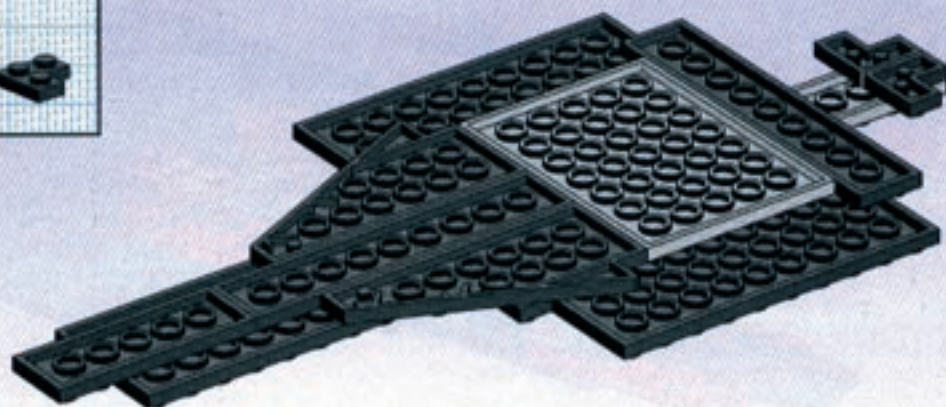

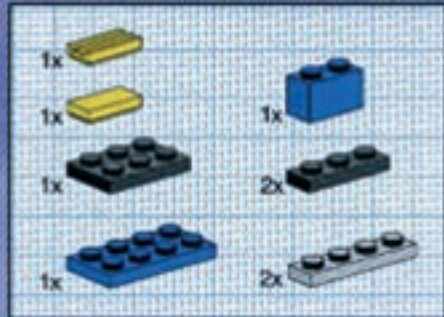

6

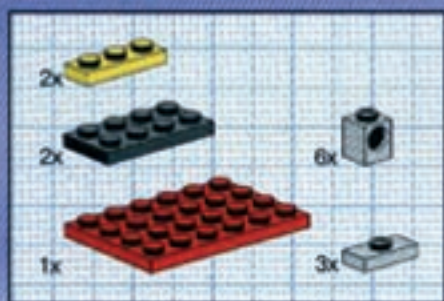
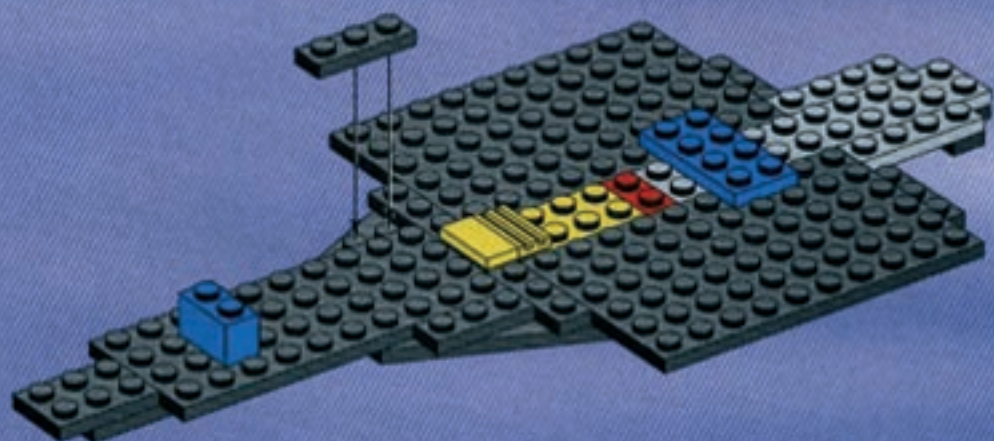

7

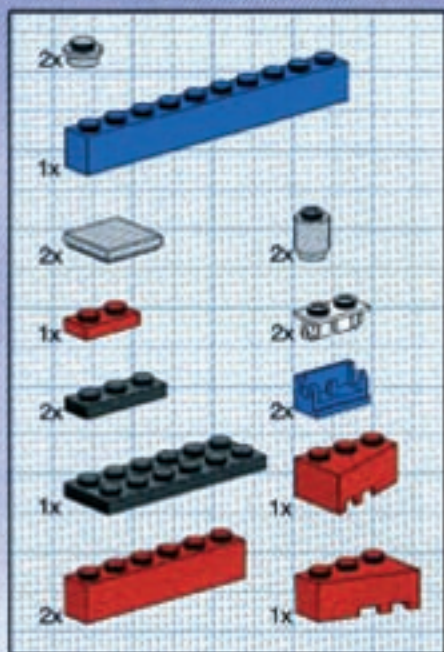
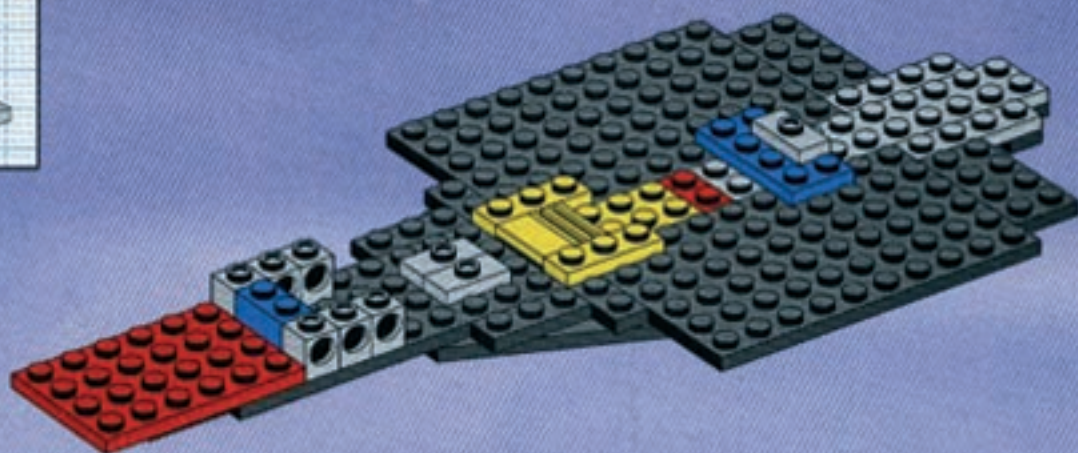

8

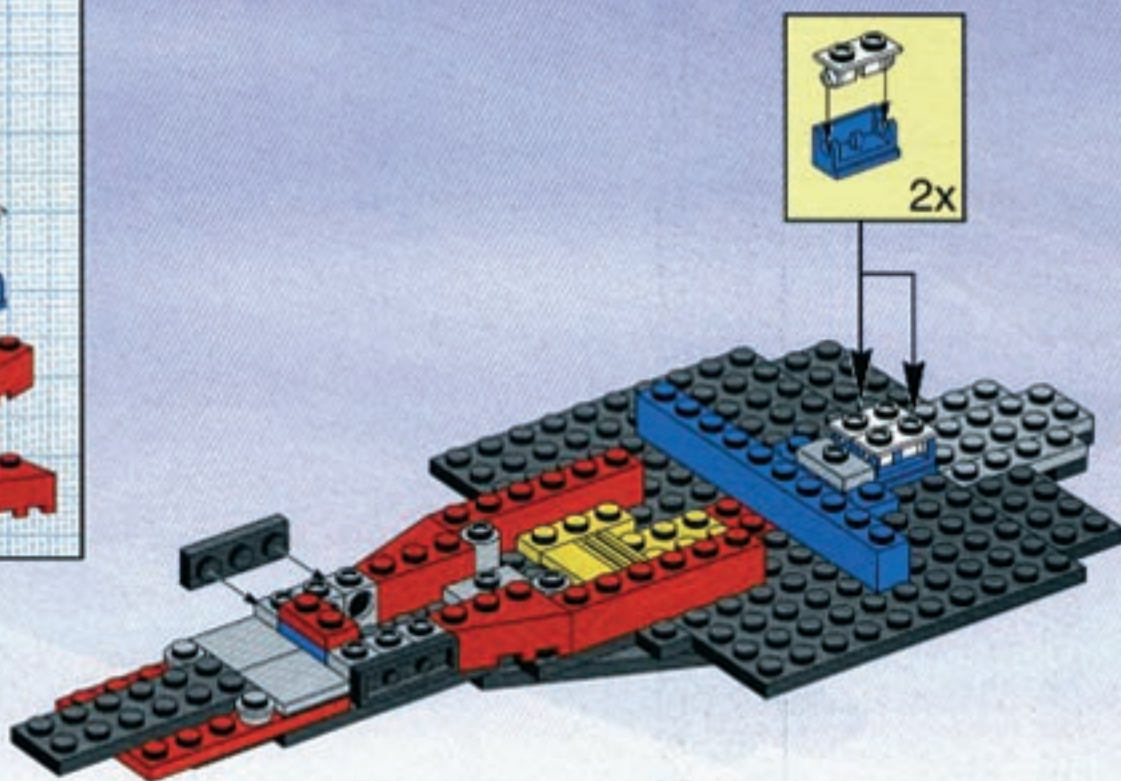

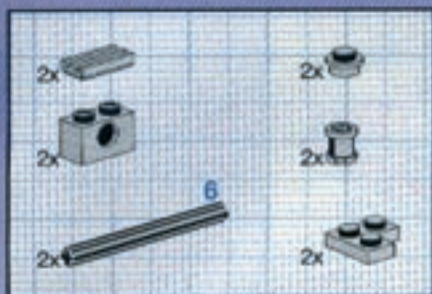

5

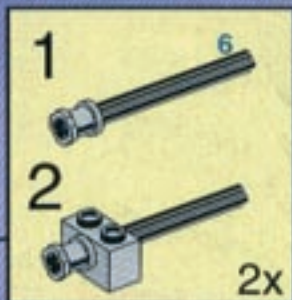
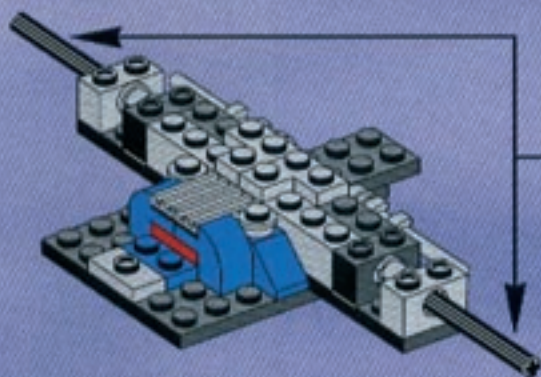

6

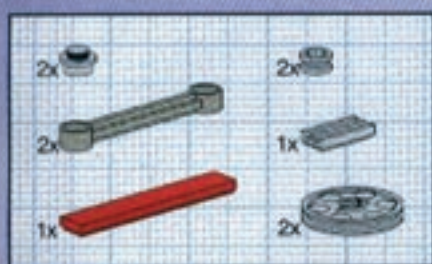
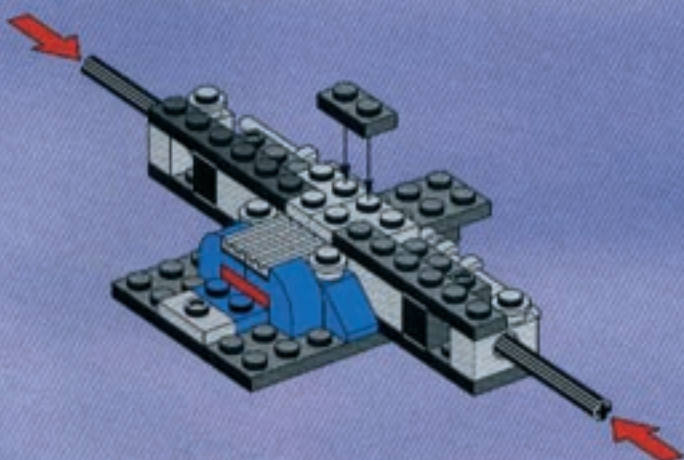

7

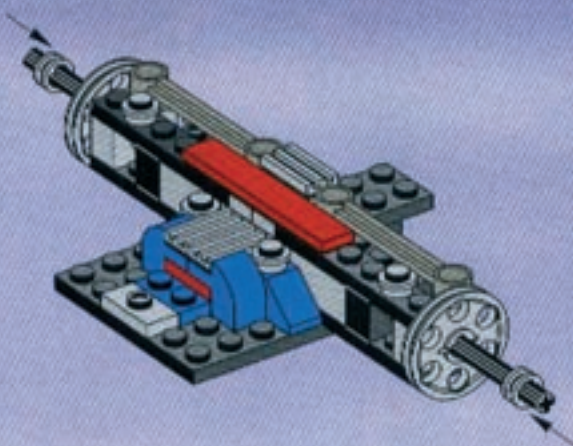

11

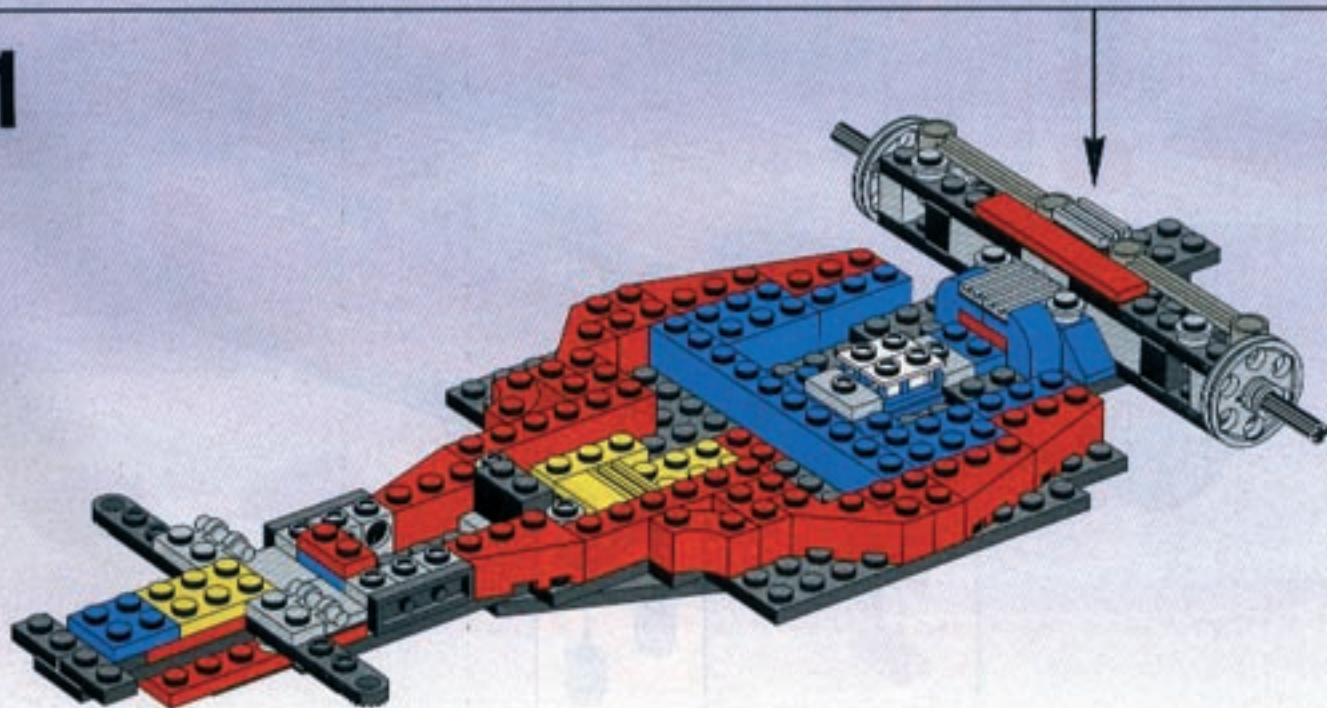

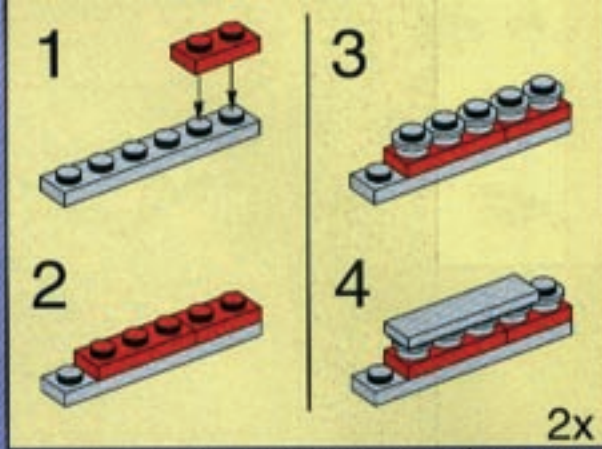
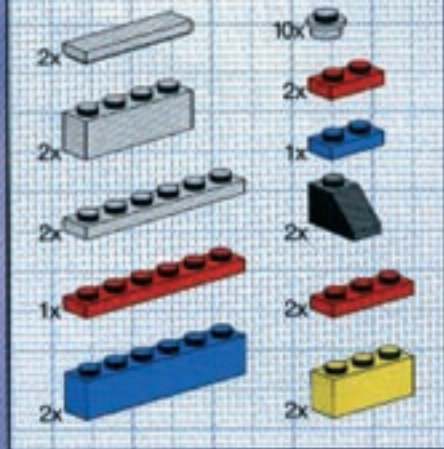

12

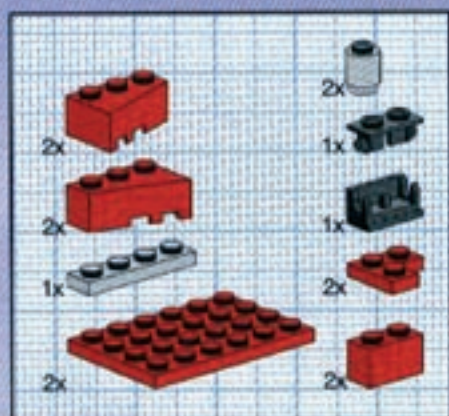
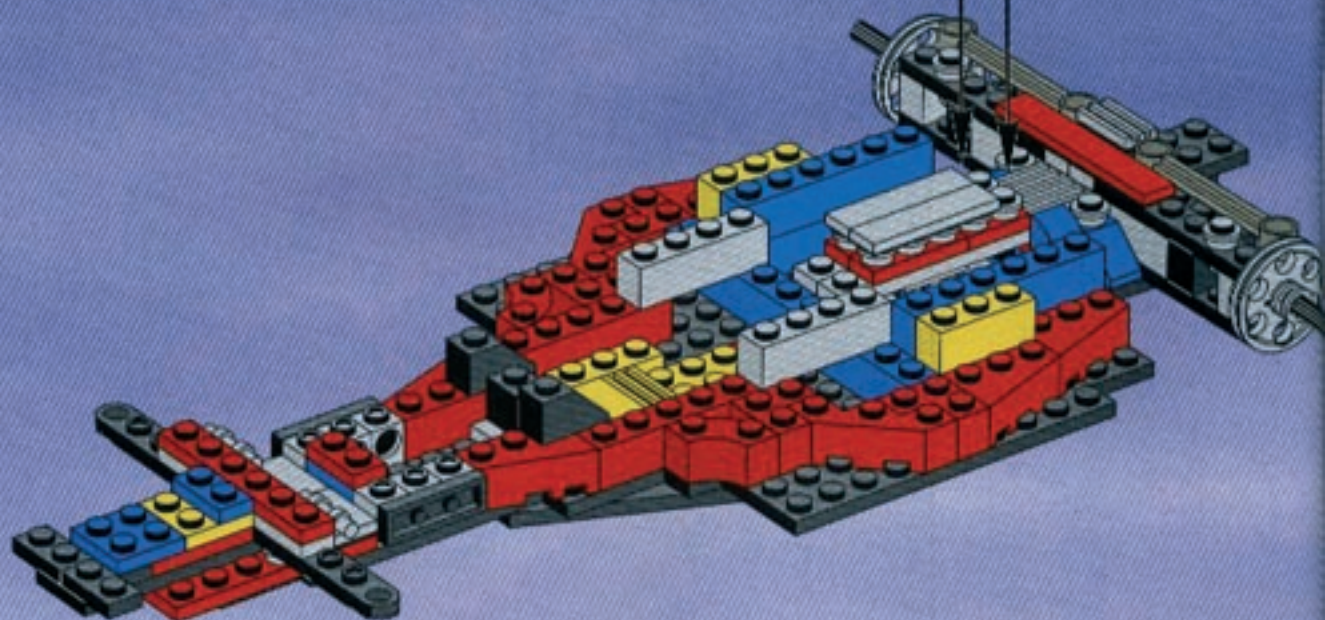

13

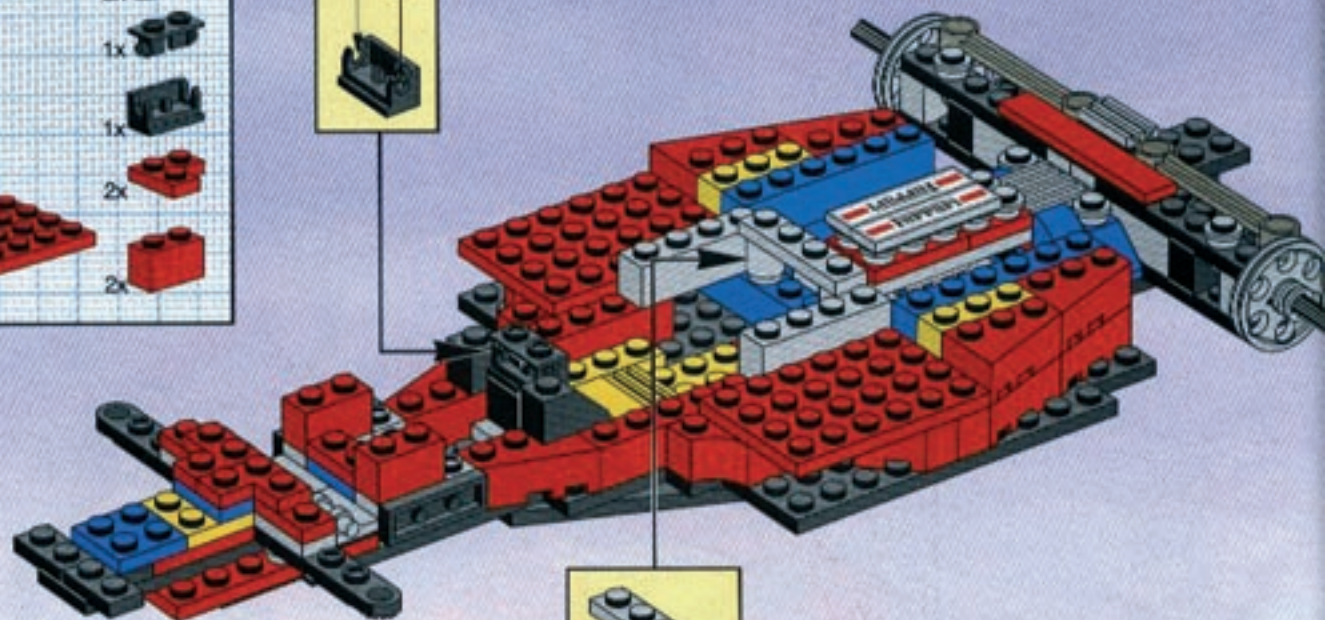

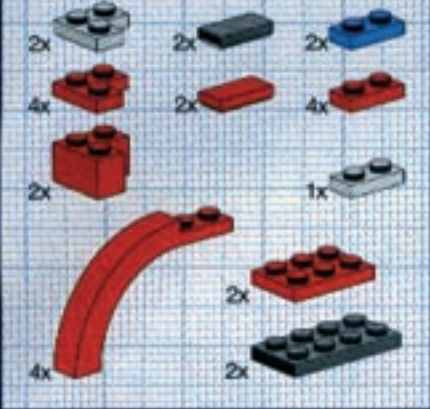

14

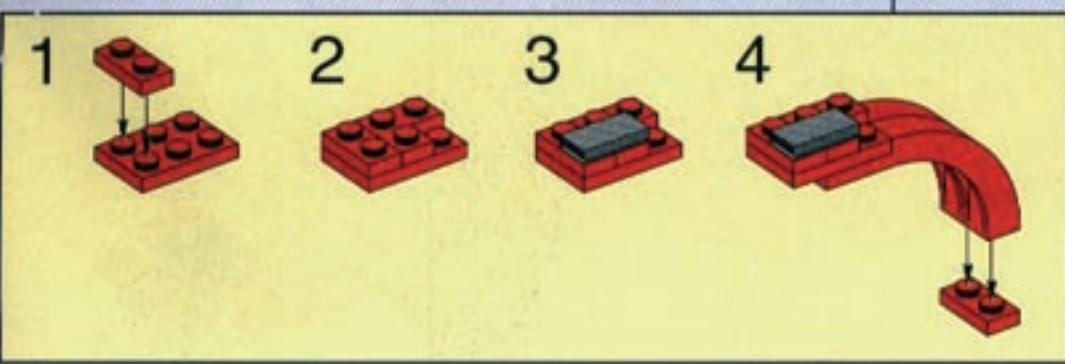
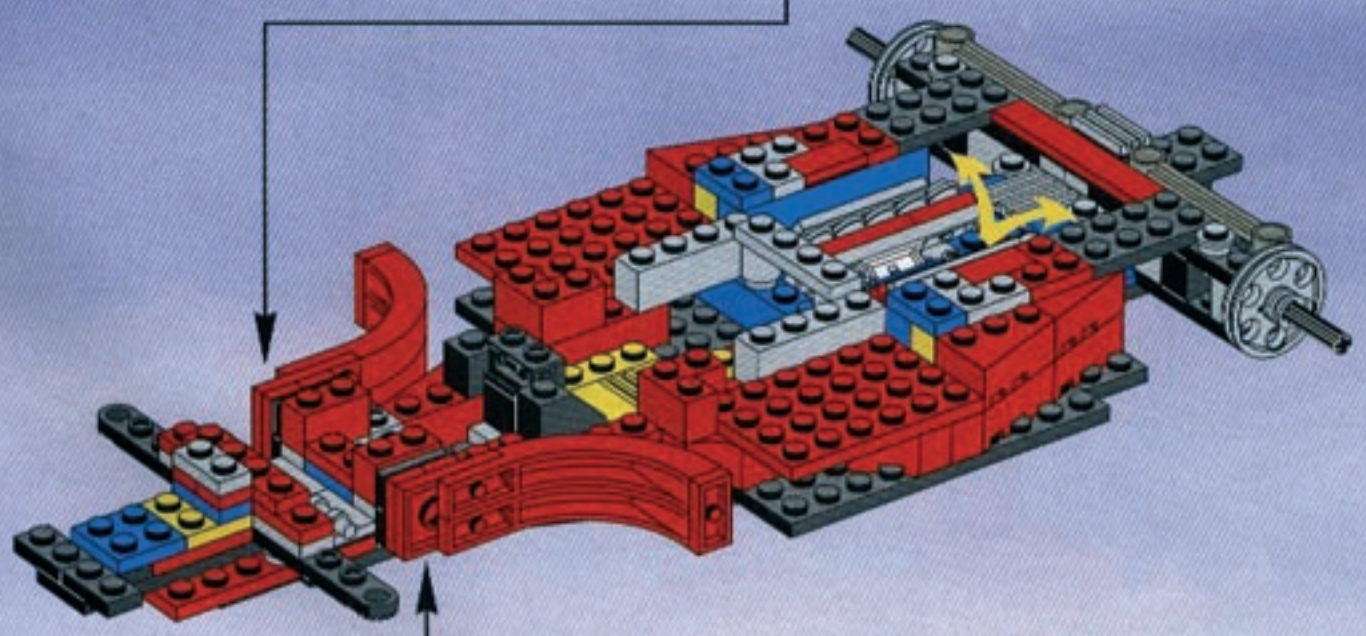
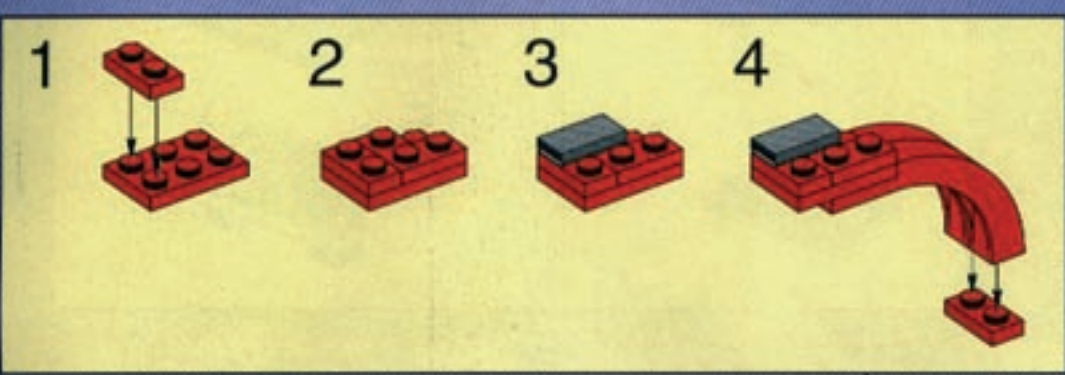

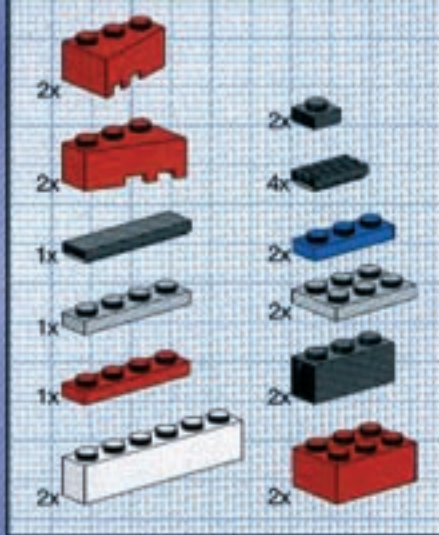

15

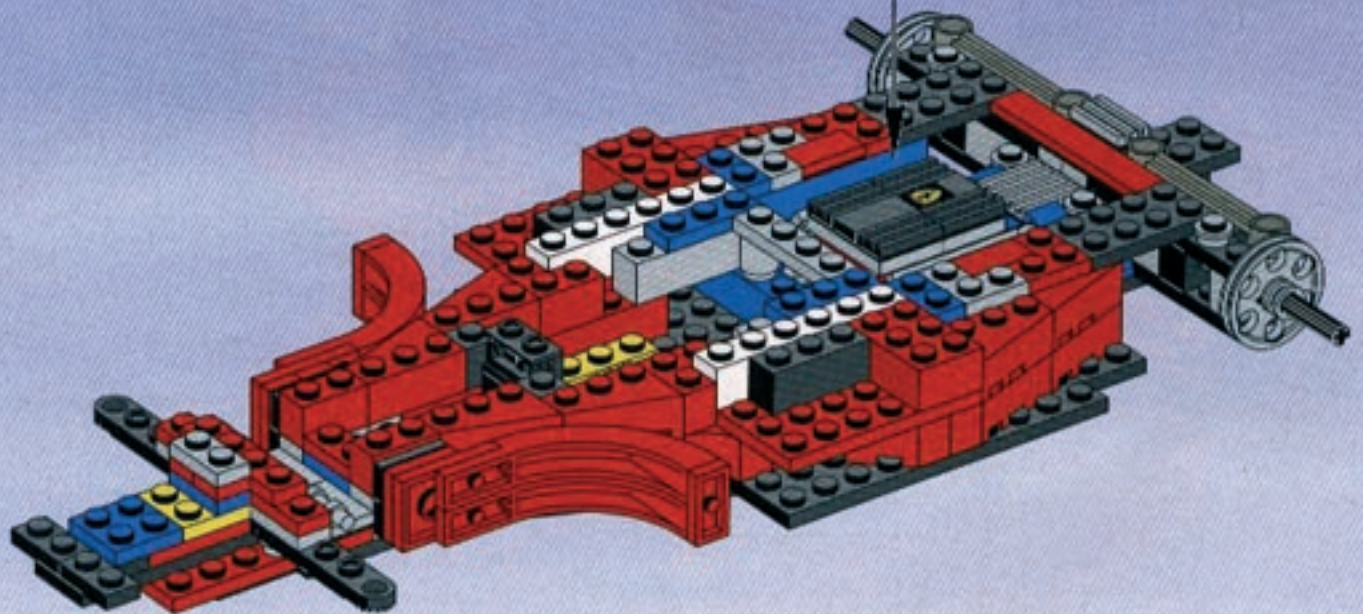
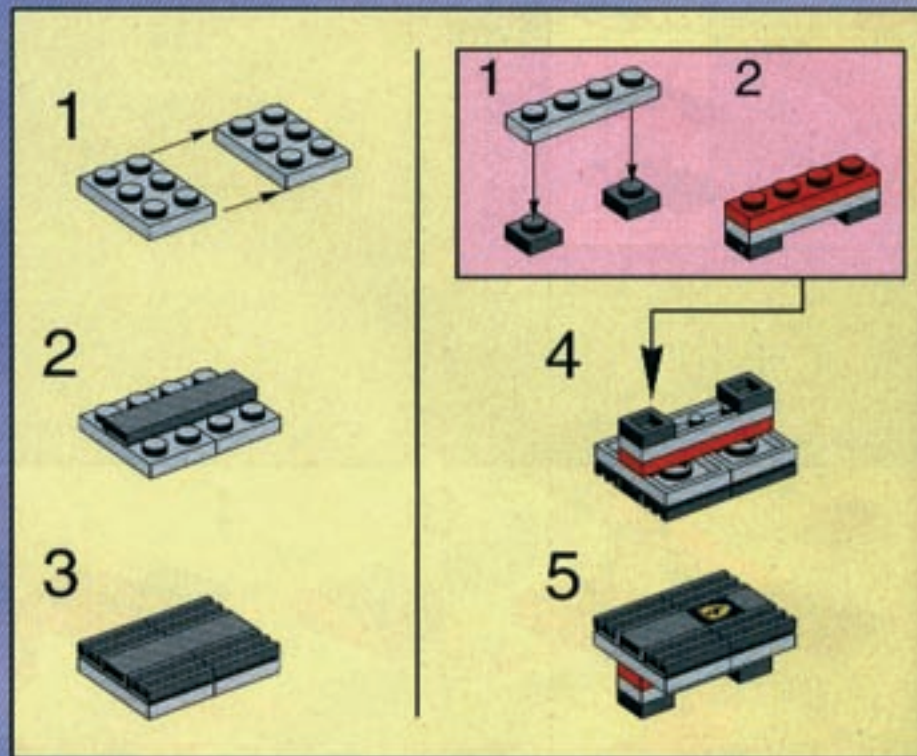

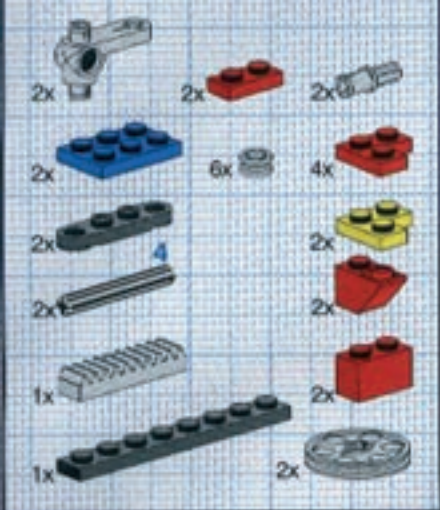

16

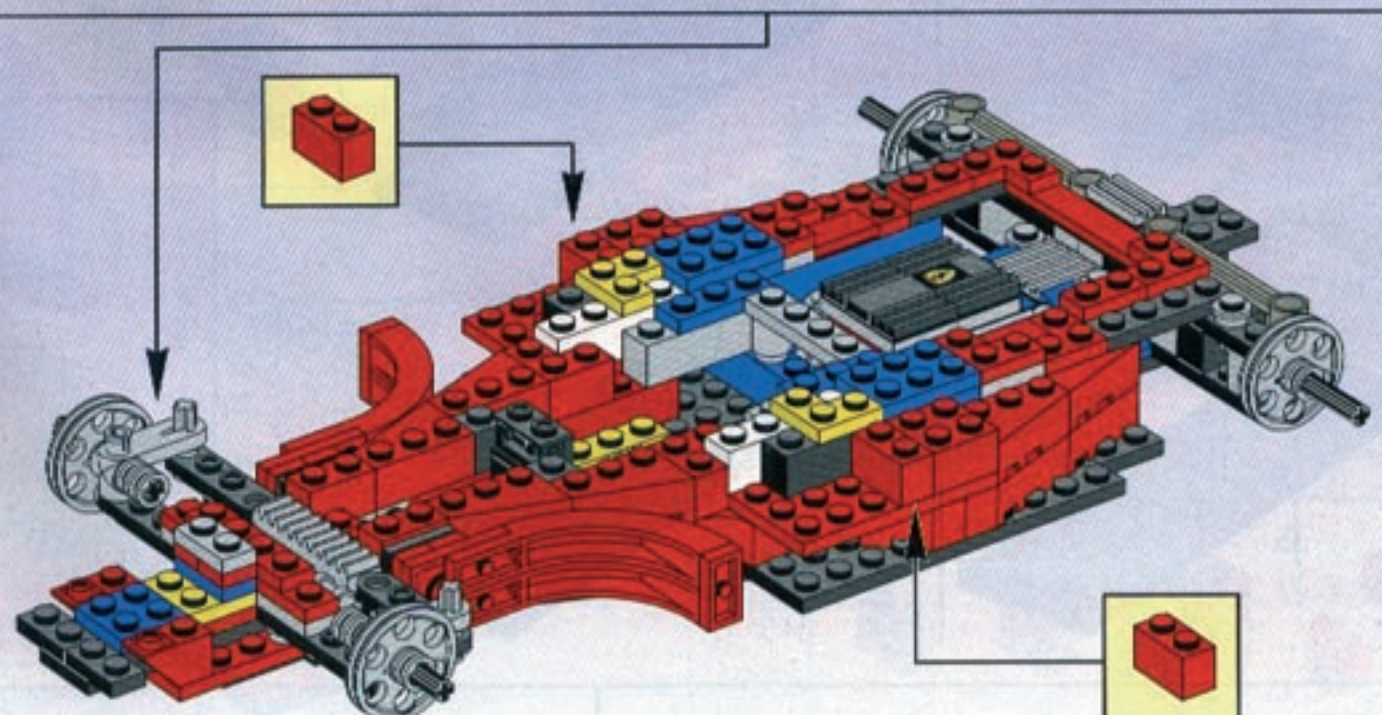
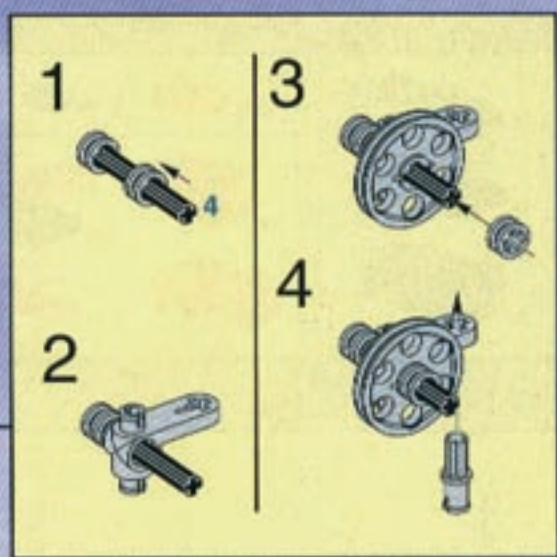
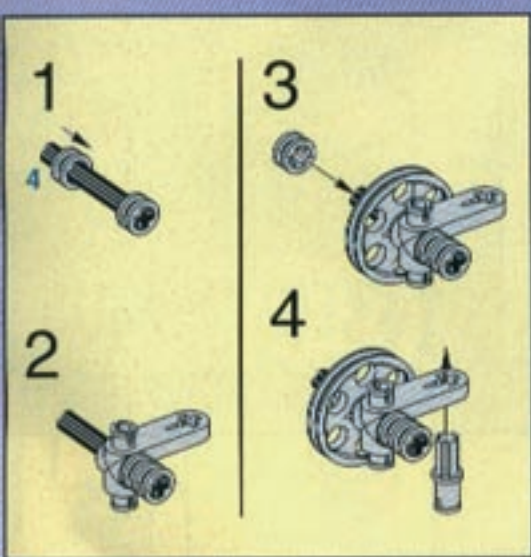
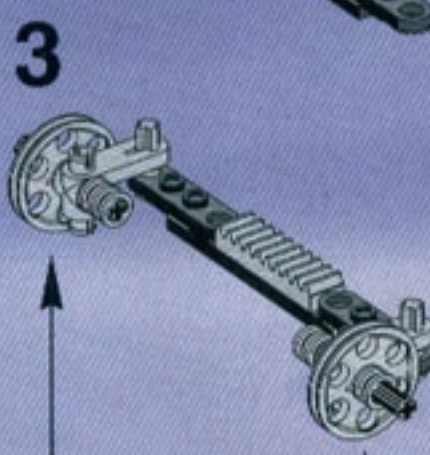
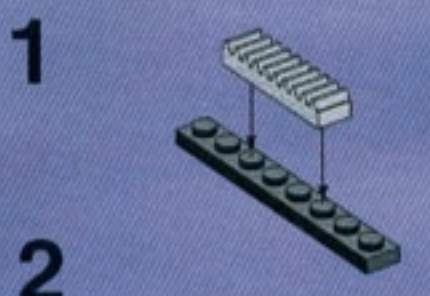

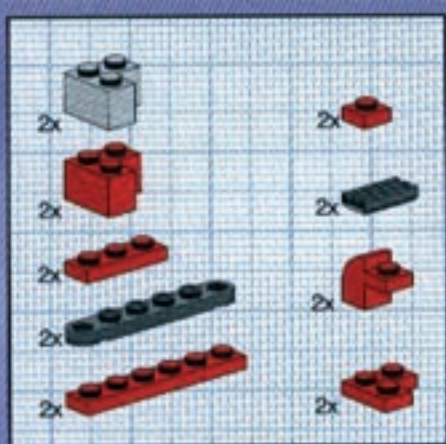

17

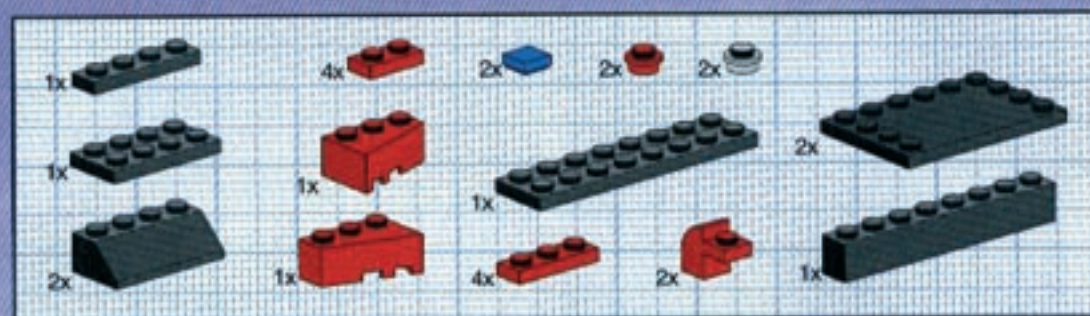
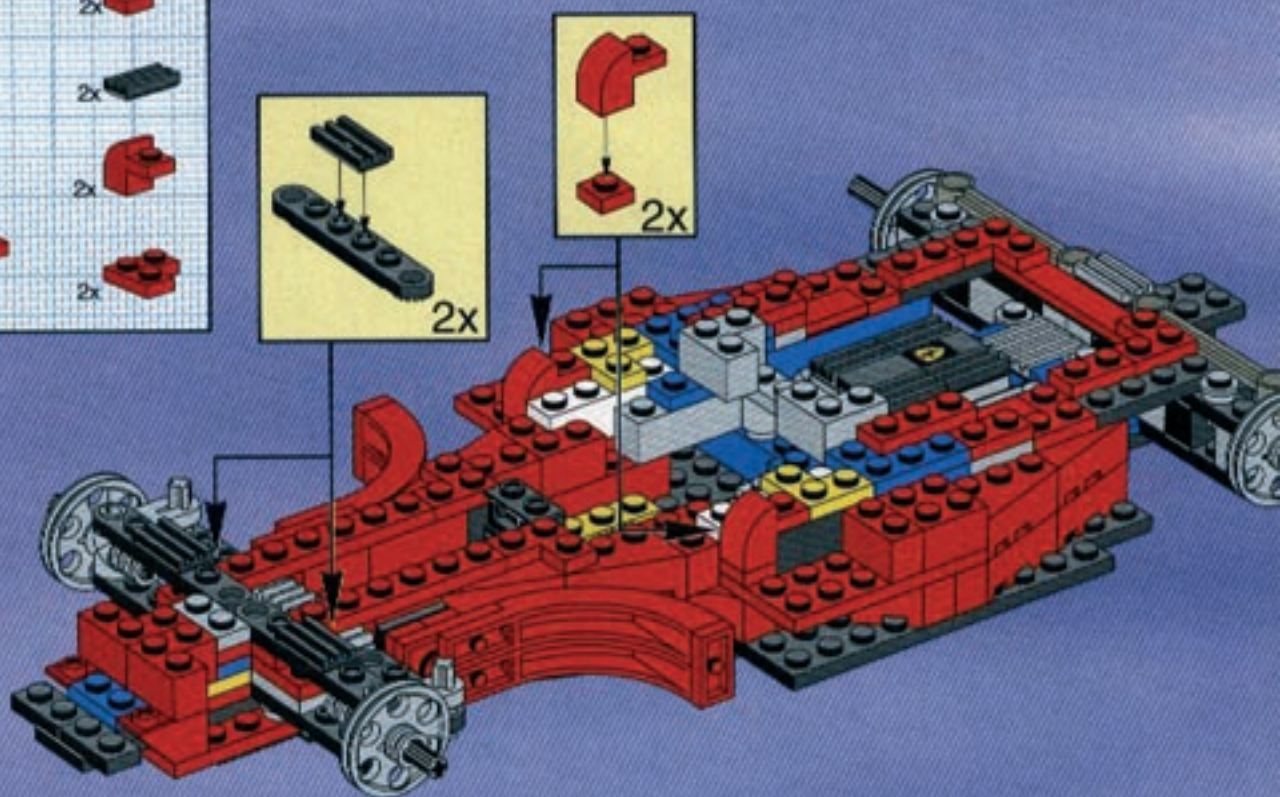

18

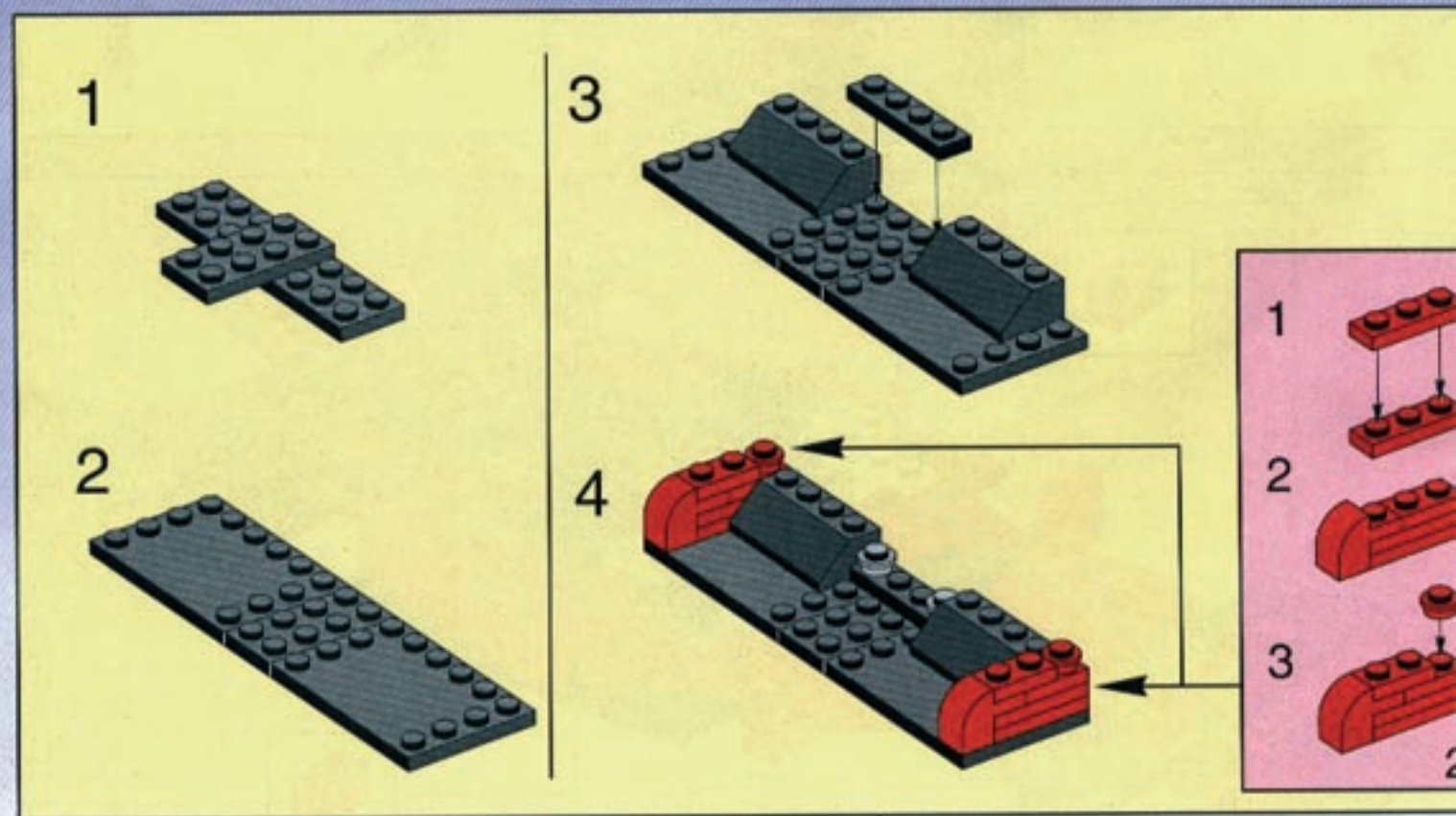

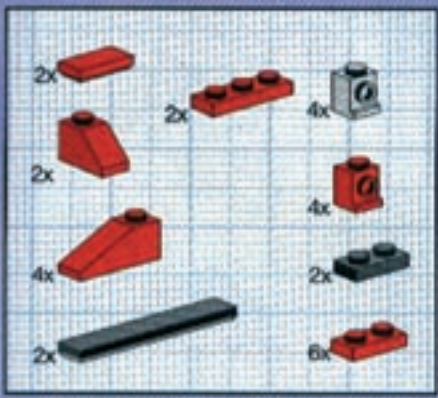
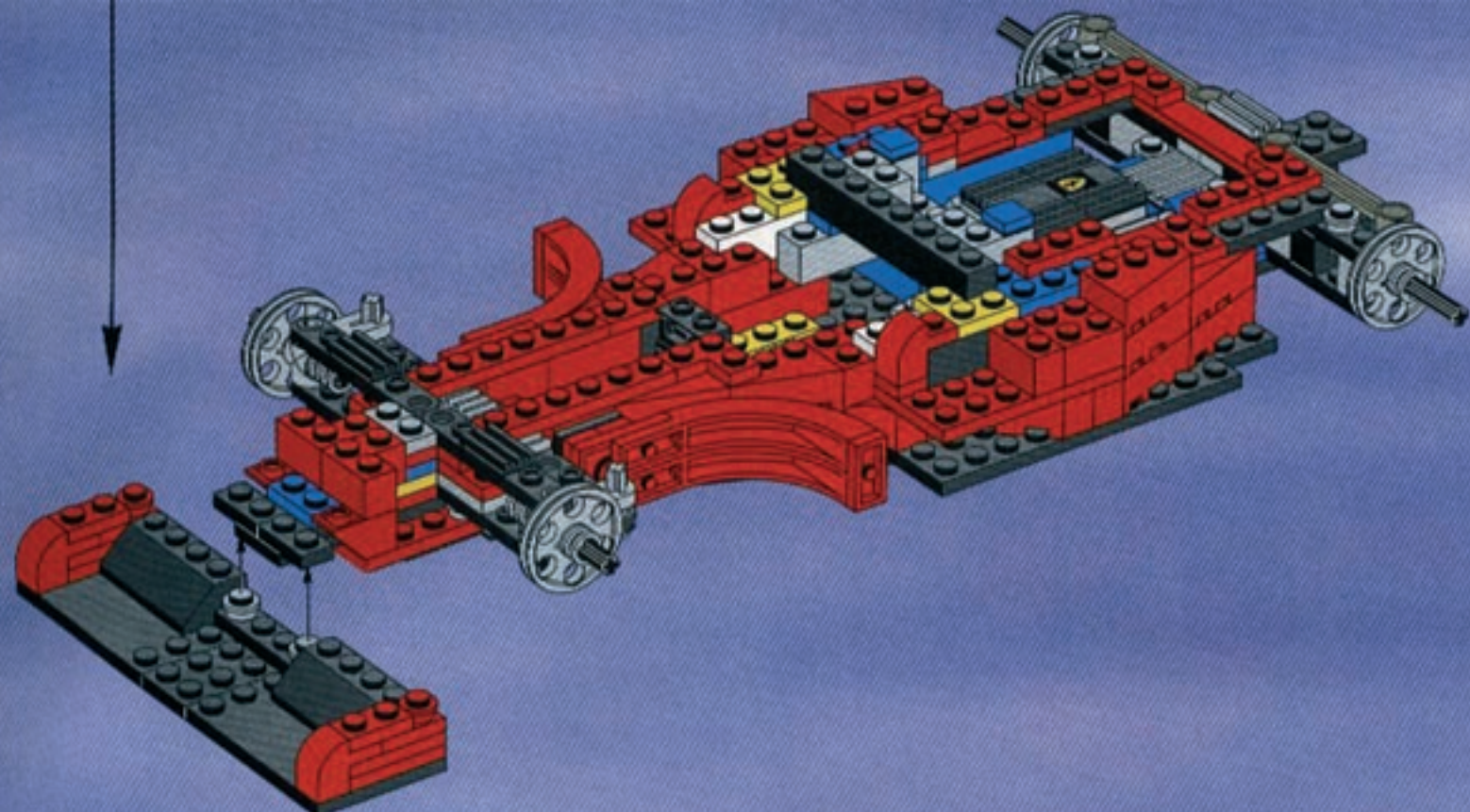

19

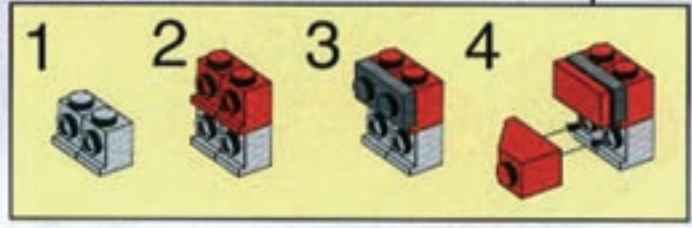
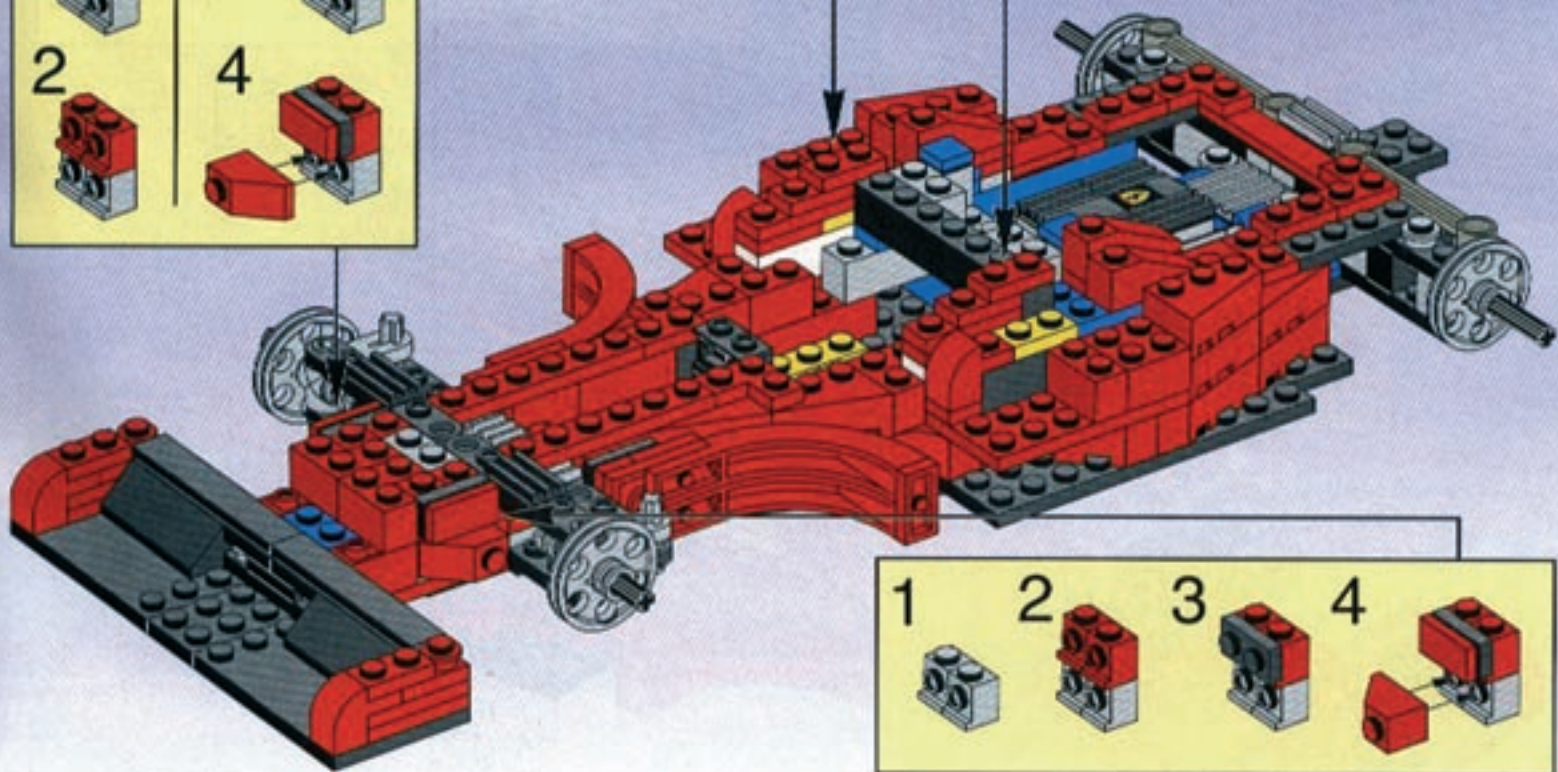
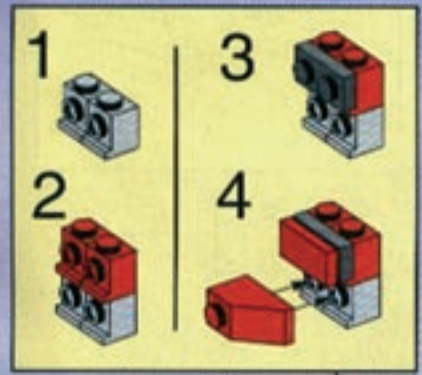
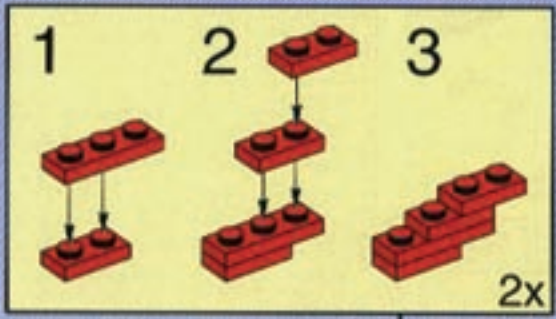

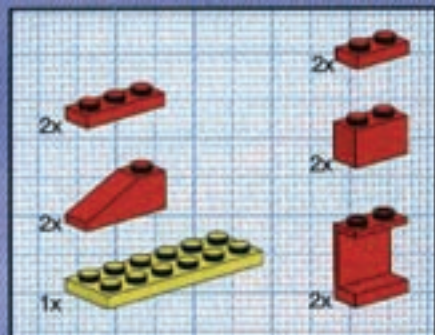

20

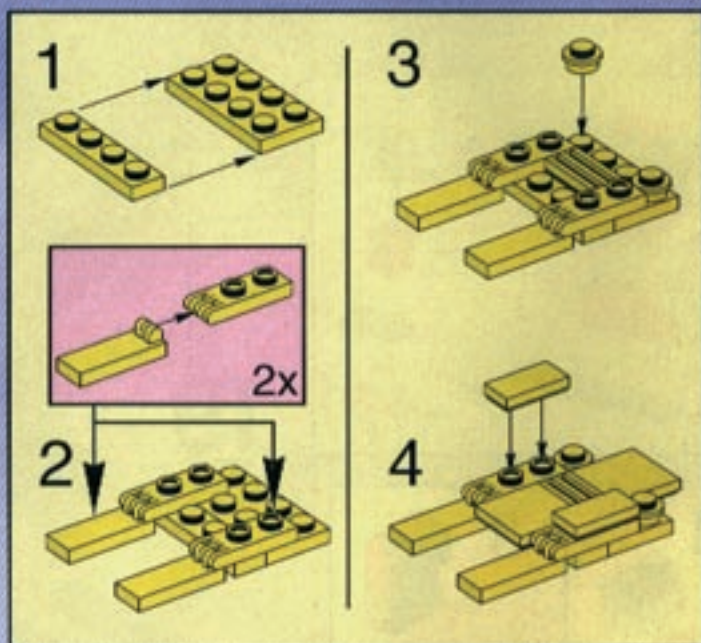
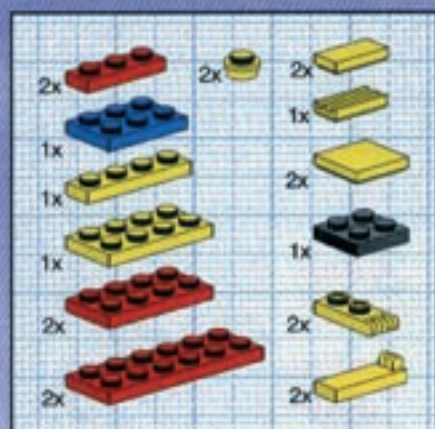
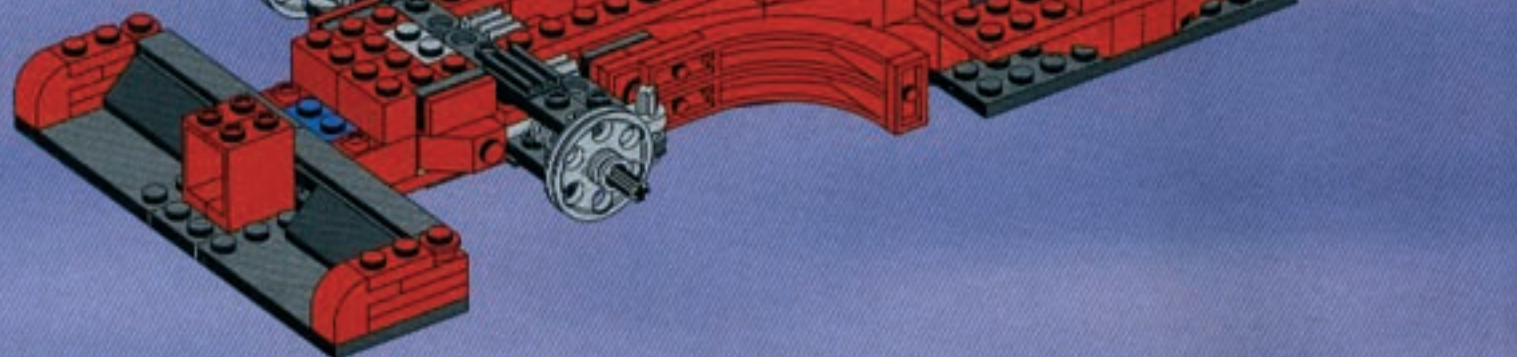

21

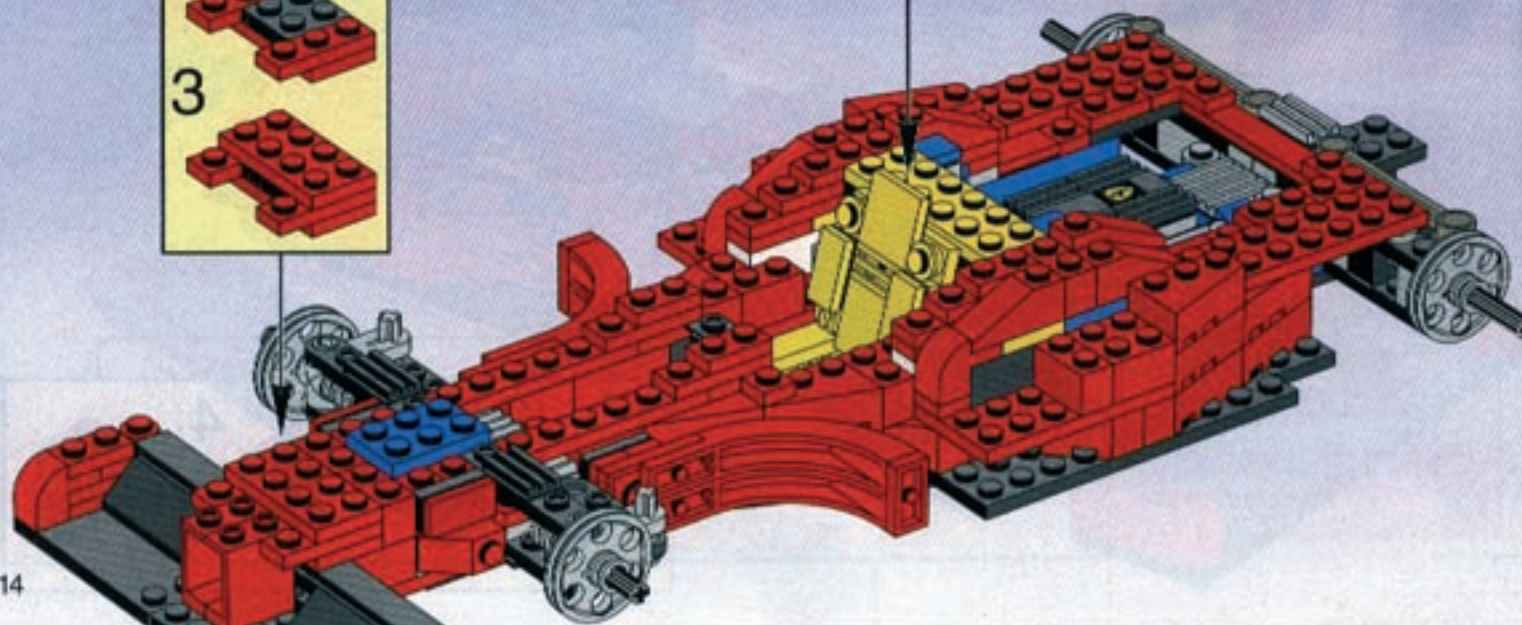
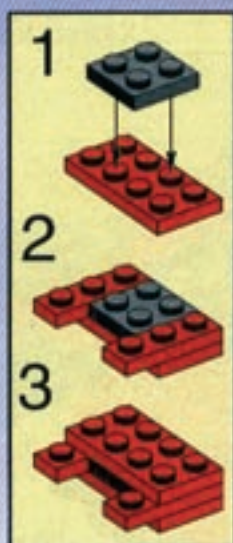

- 1x
- 1x
- 2x
- 1x
- 1x
- 1x
- 1x
- 4x
- 2x
- 1x
- 1x
- 1x
- 1x

22

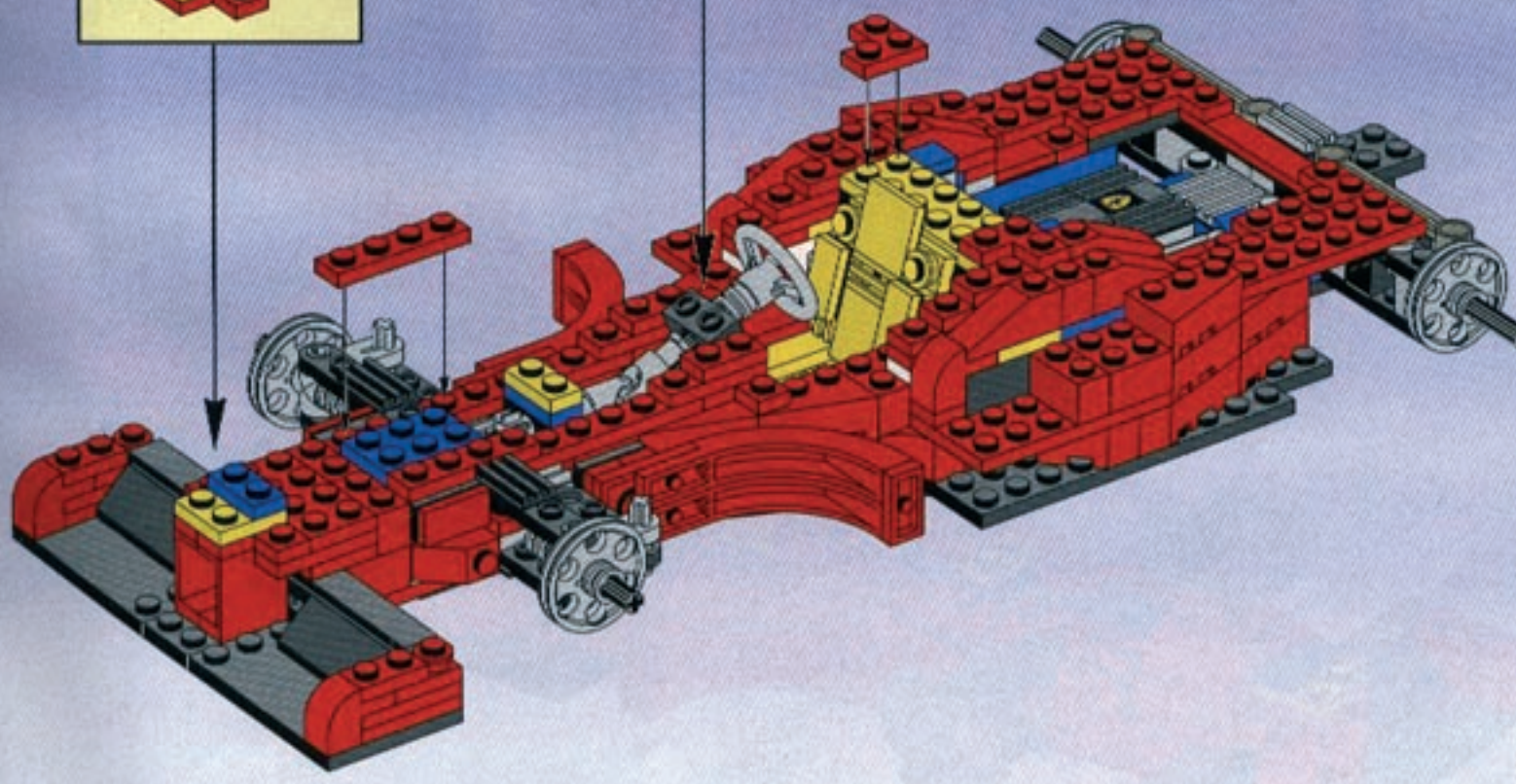
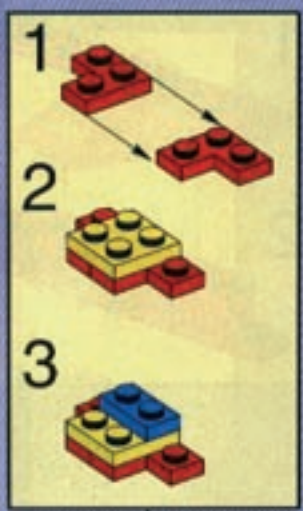
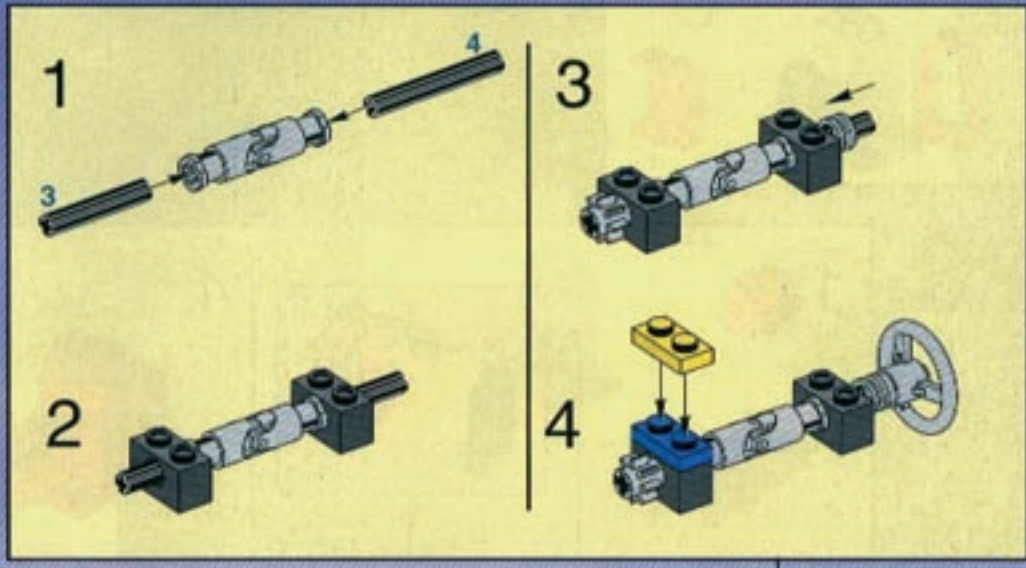

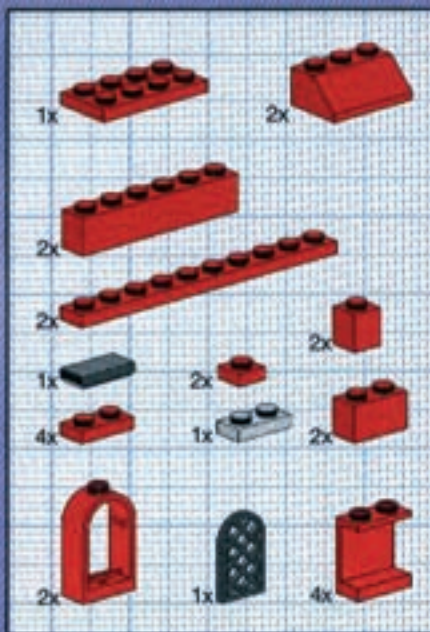

23

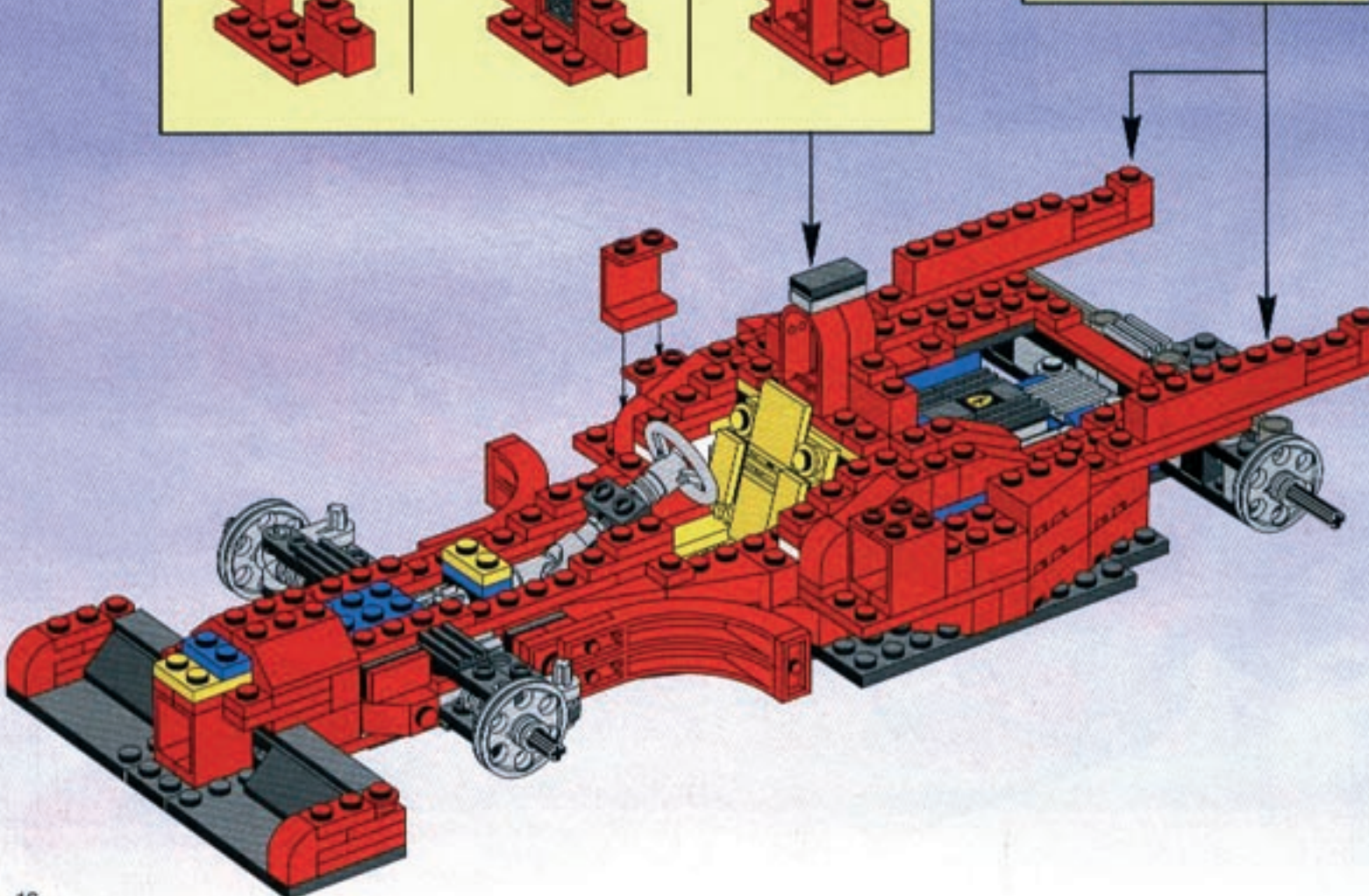
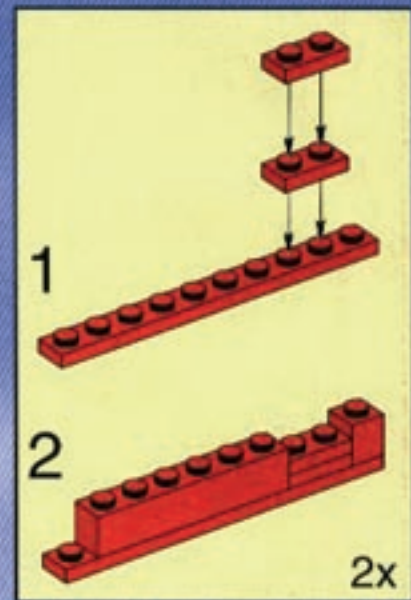
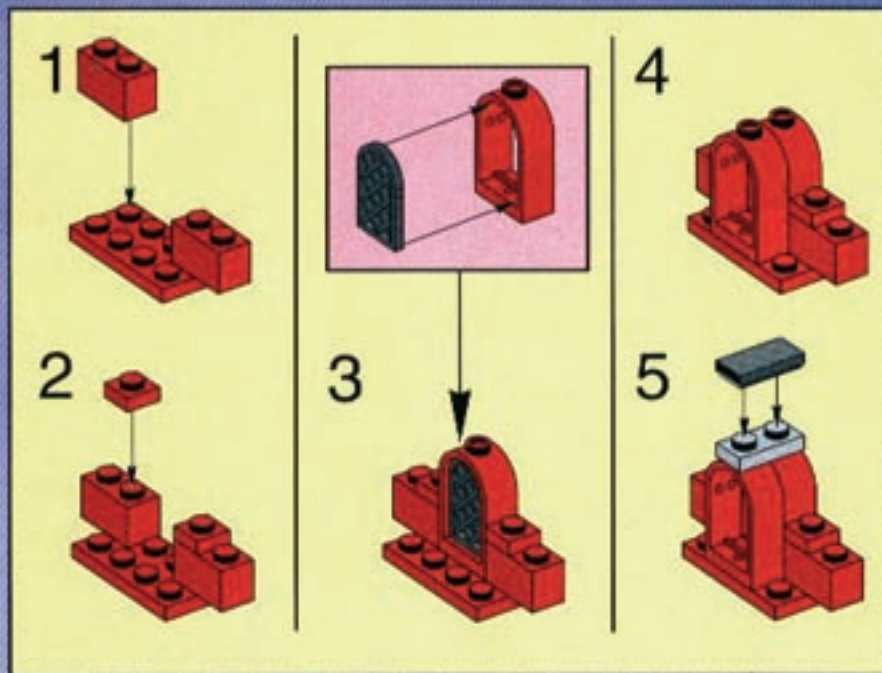

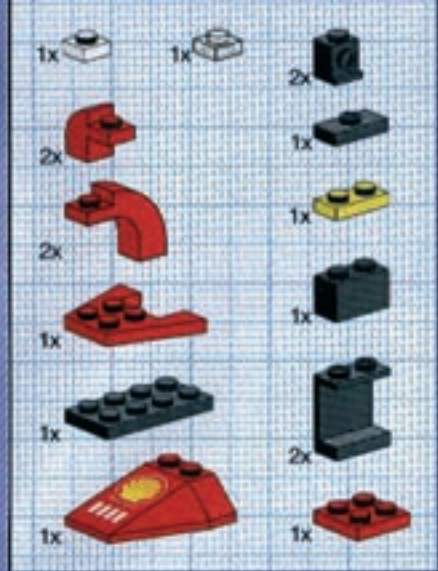

24

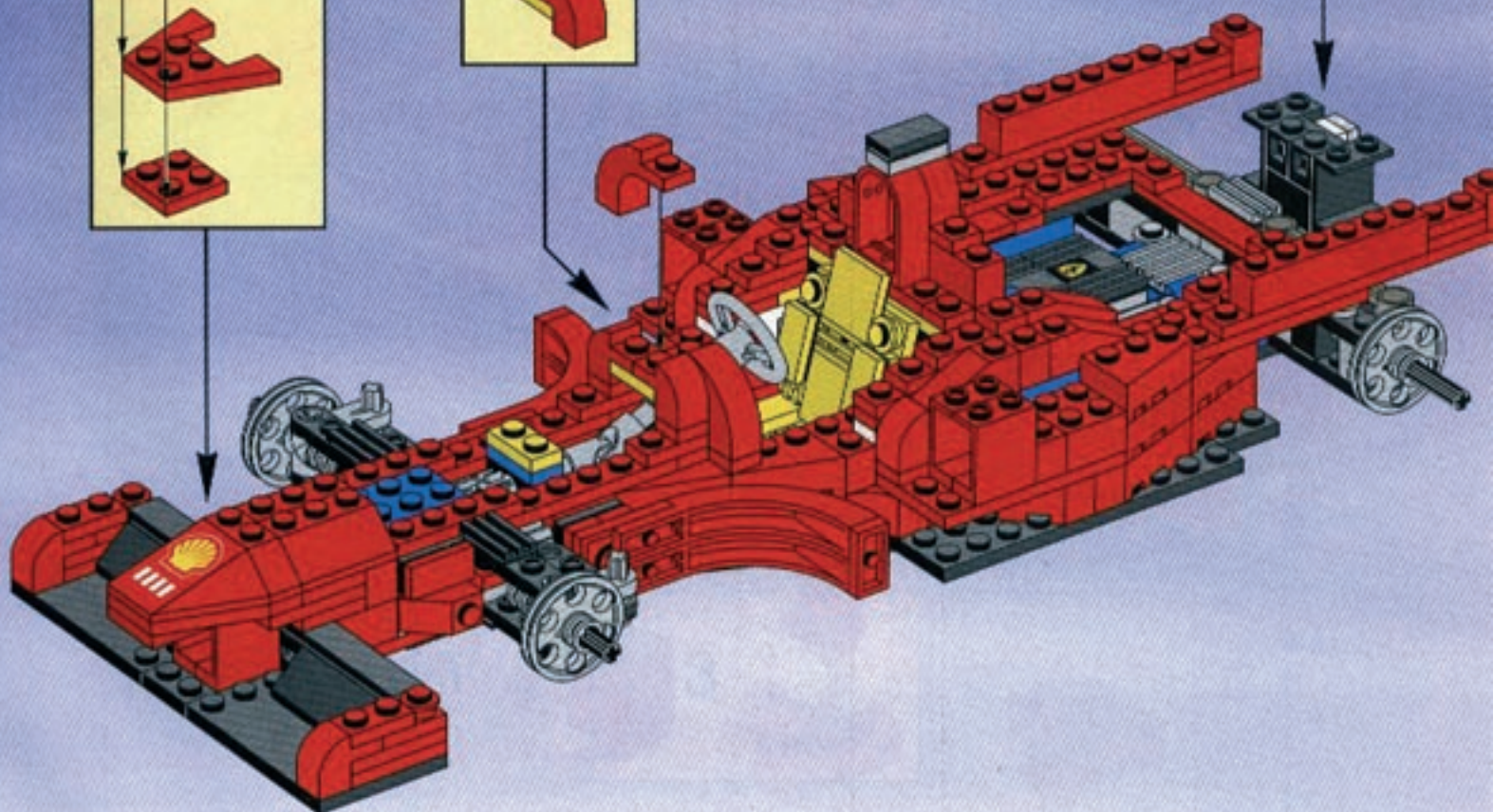
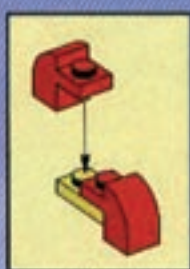
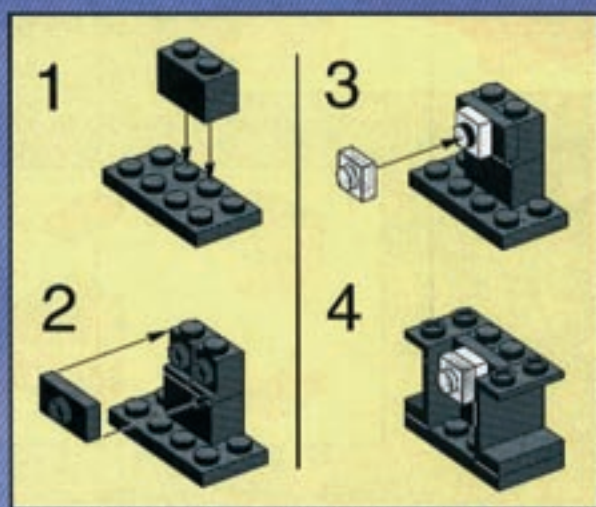

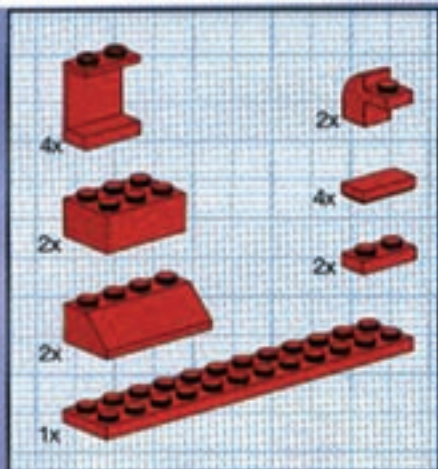

25

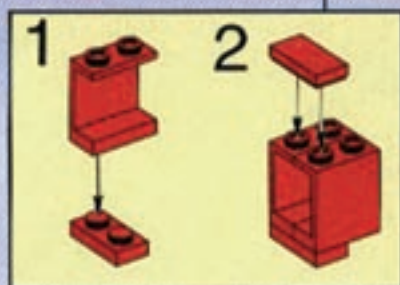
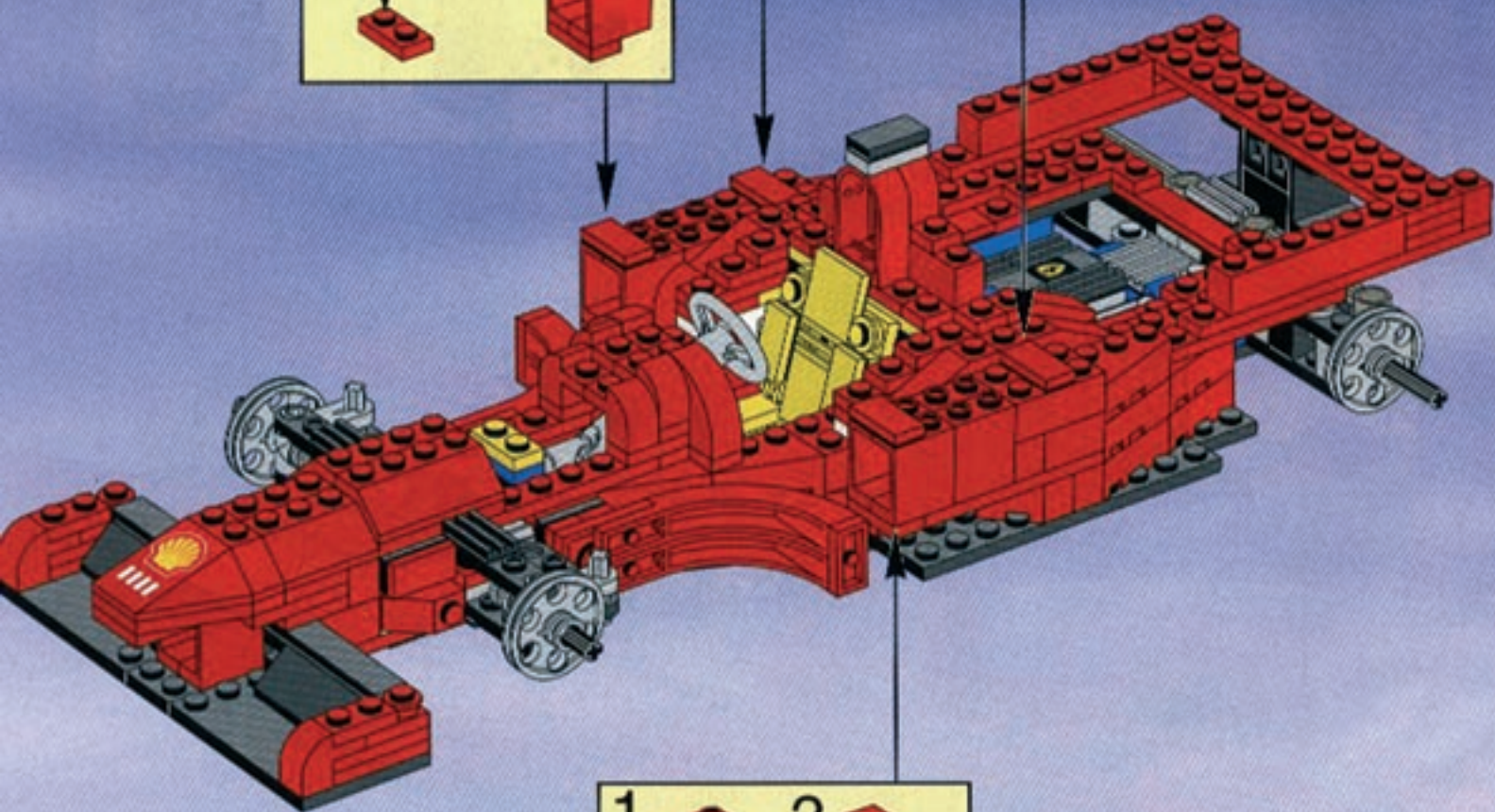
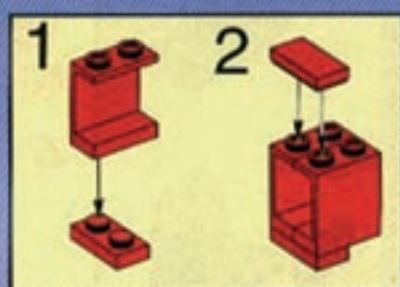

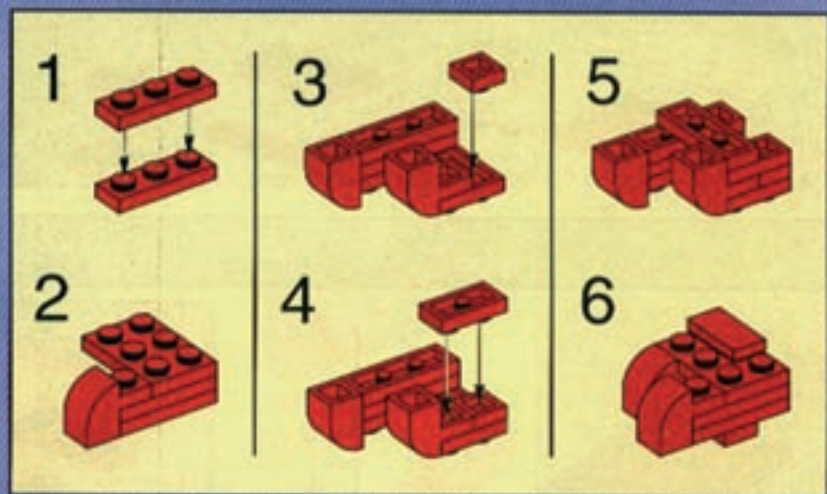
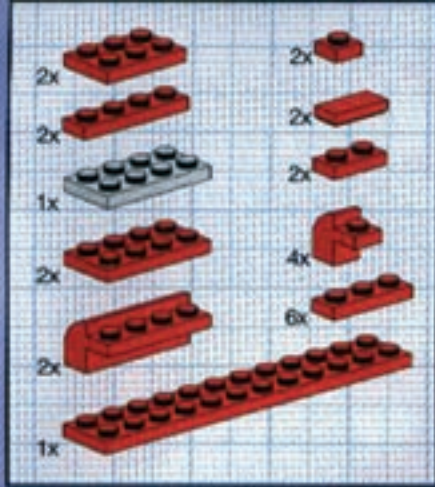

26

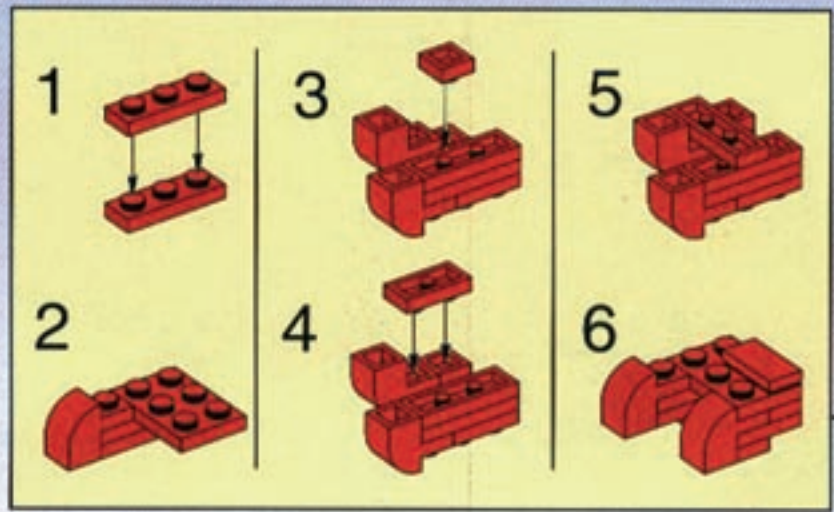
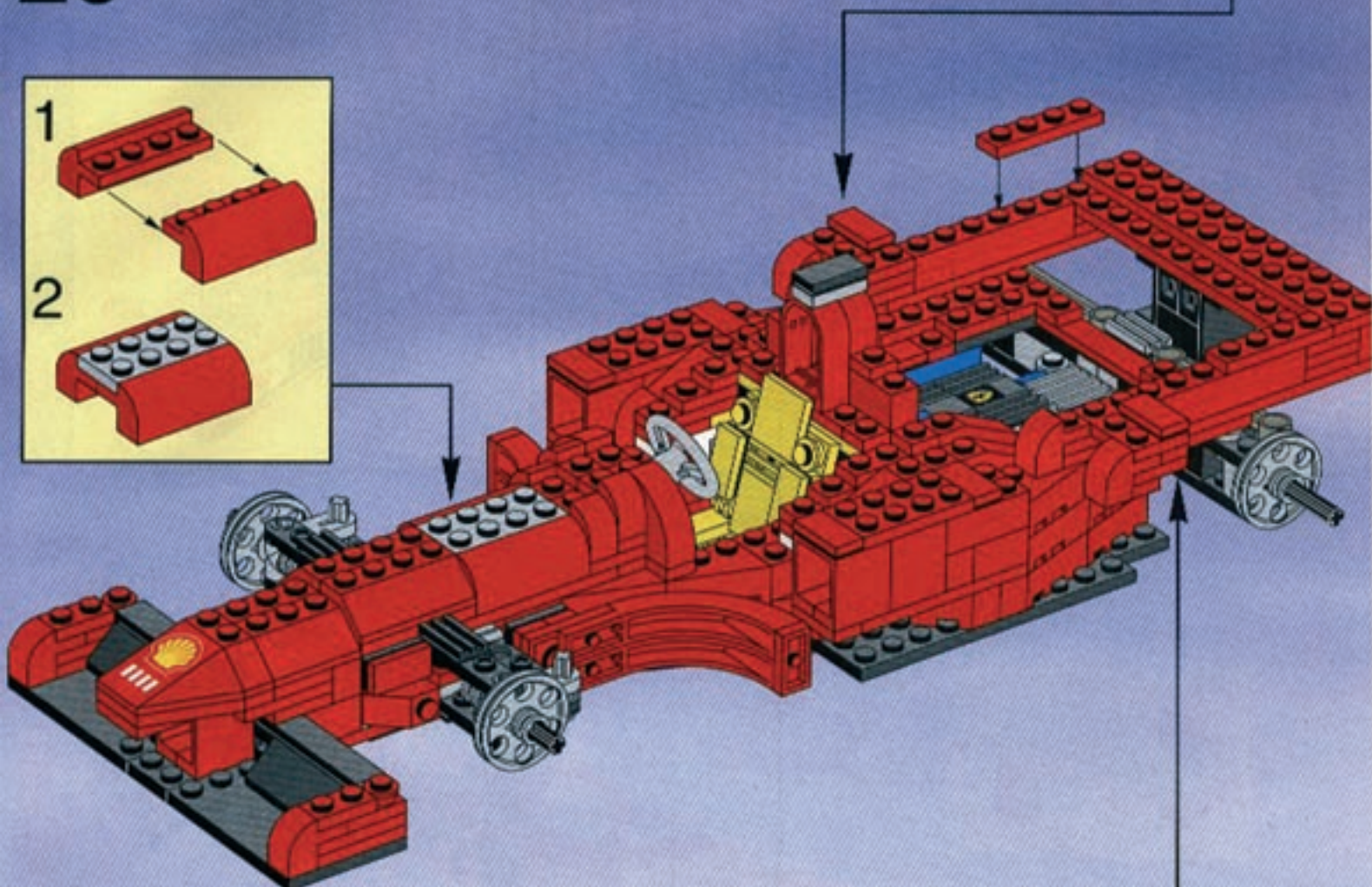
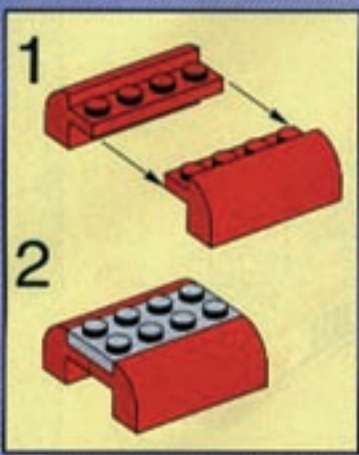

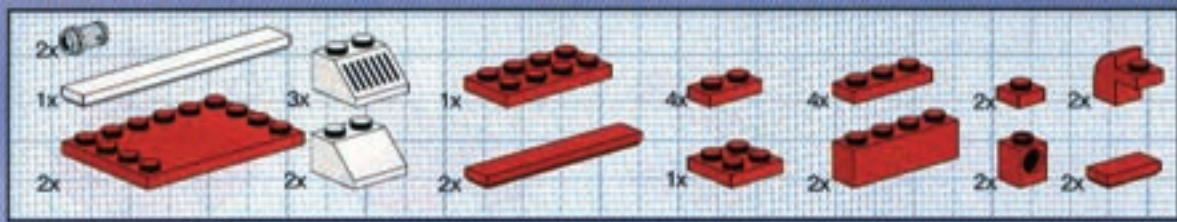

27

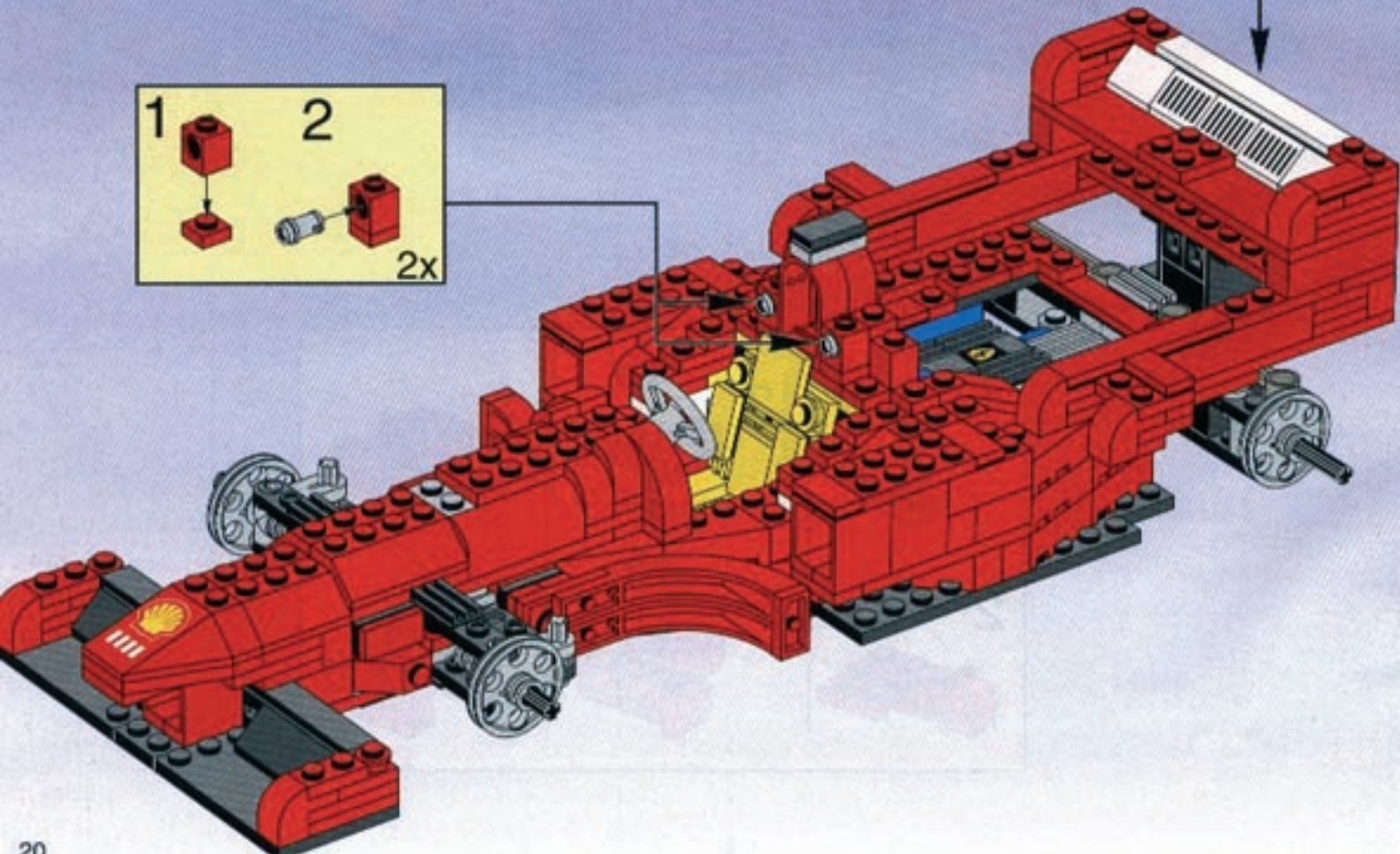
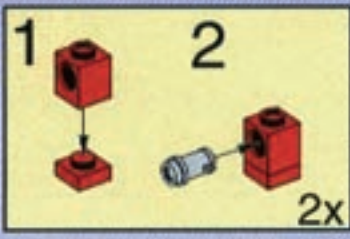
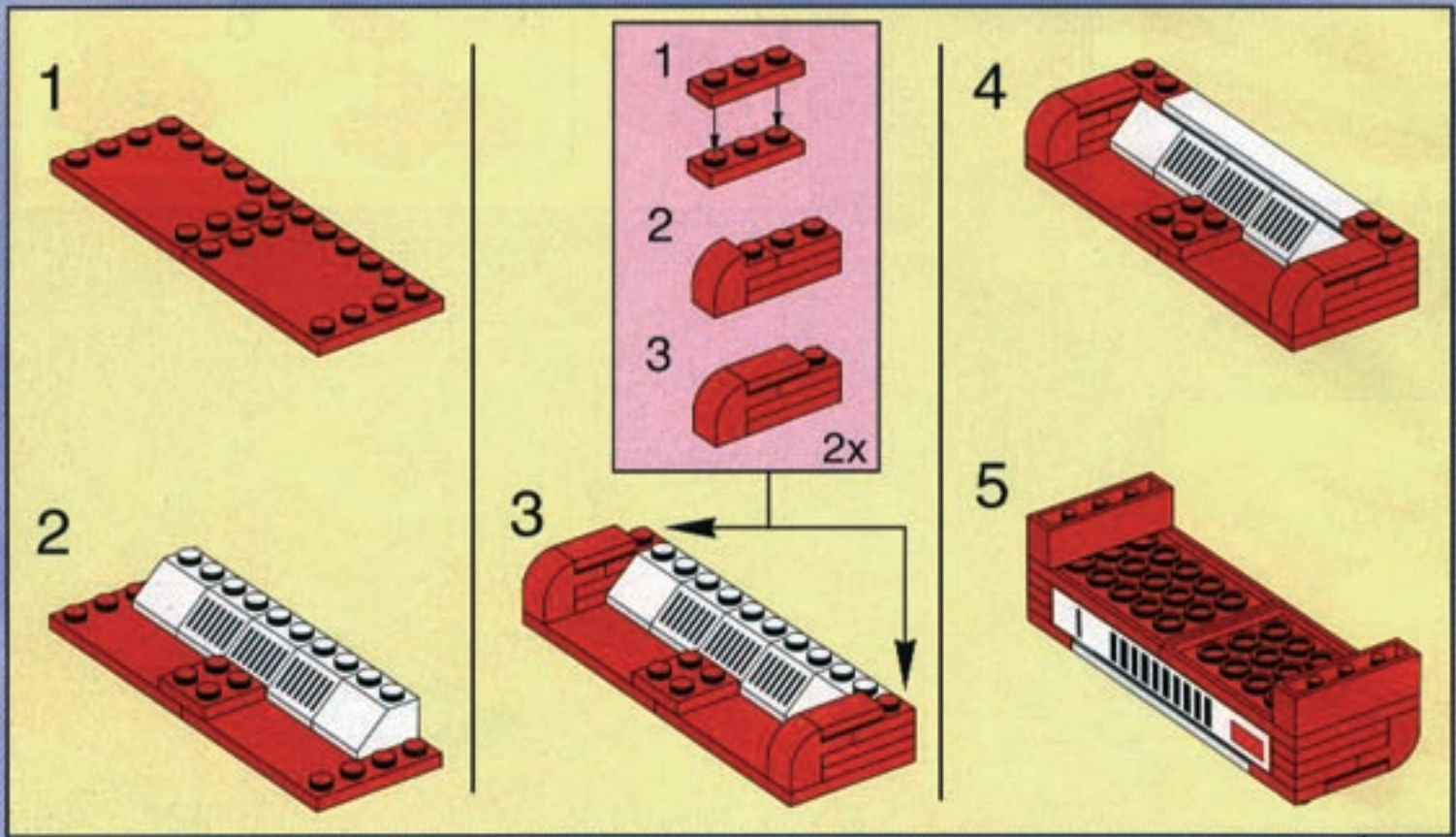

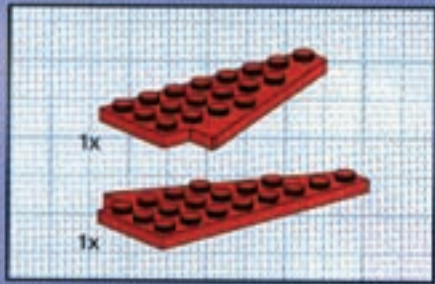
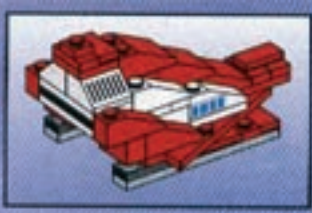

1

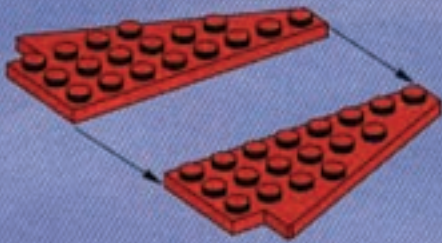

2



3

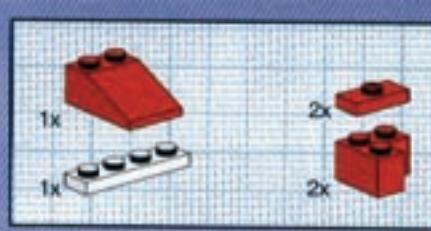
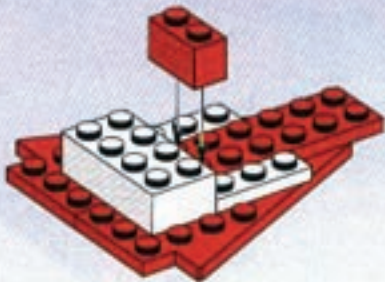

4

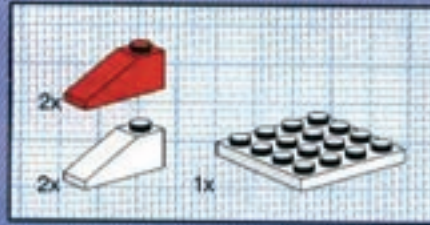
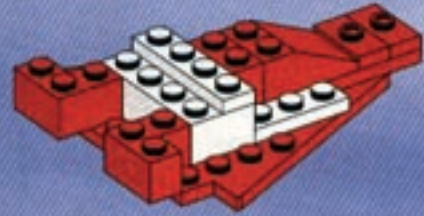

5

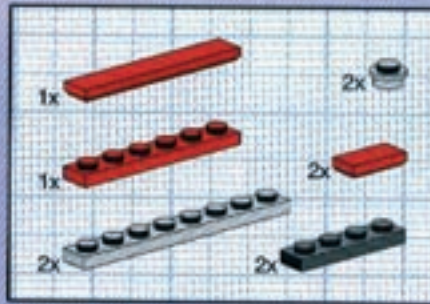
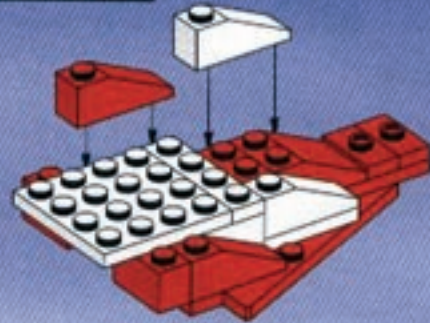

6

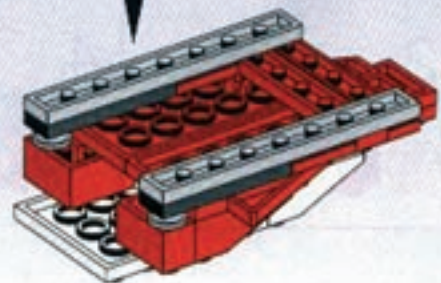
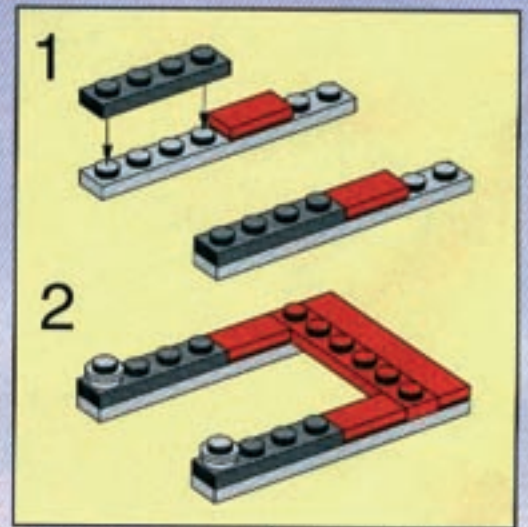

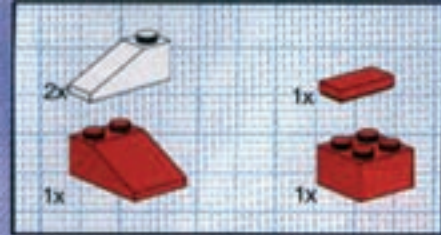

7

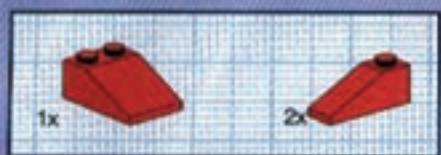

8

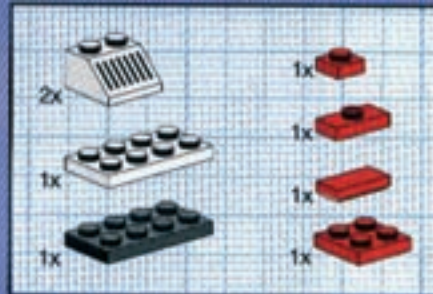
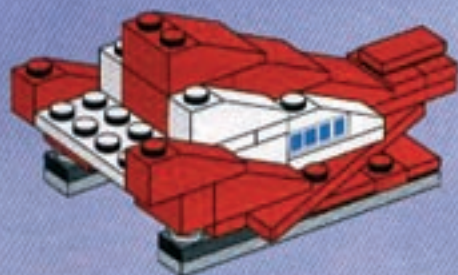

9

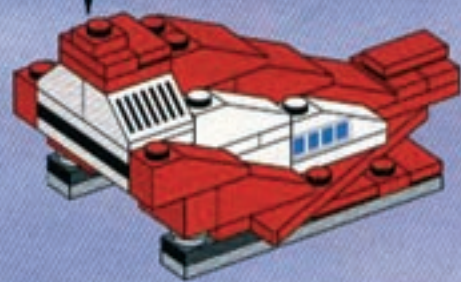
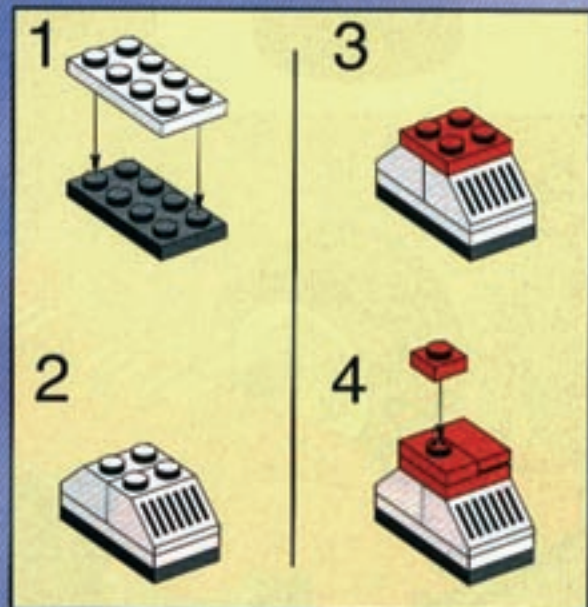

29

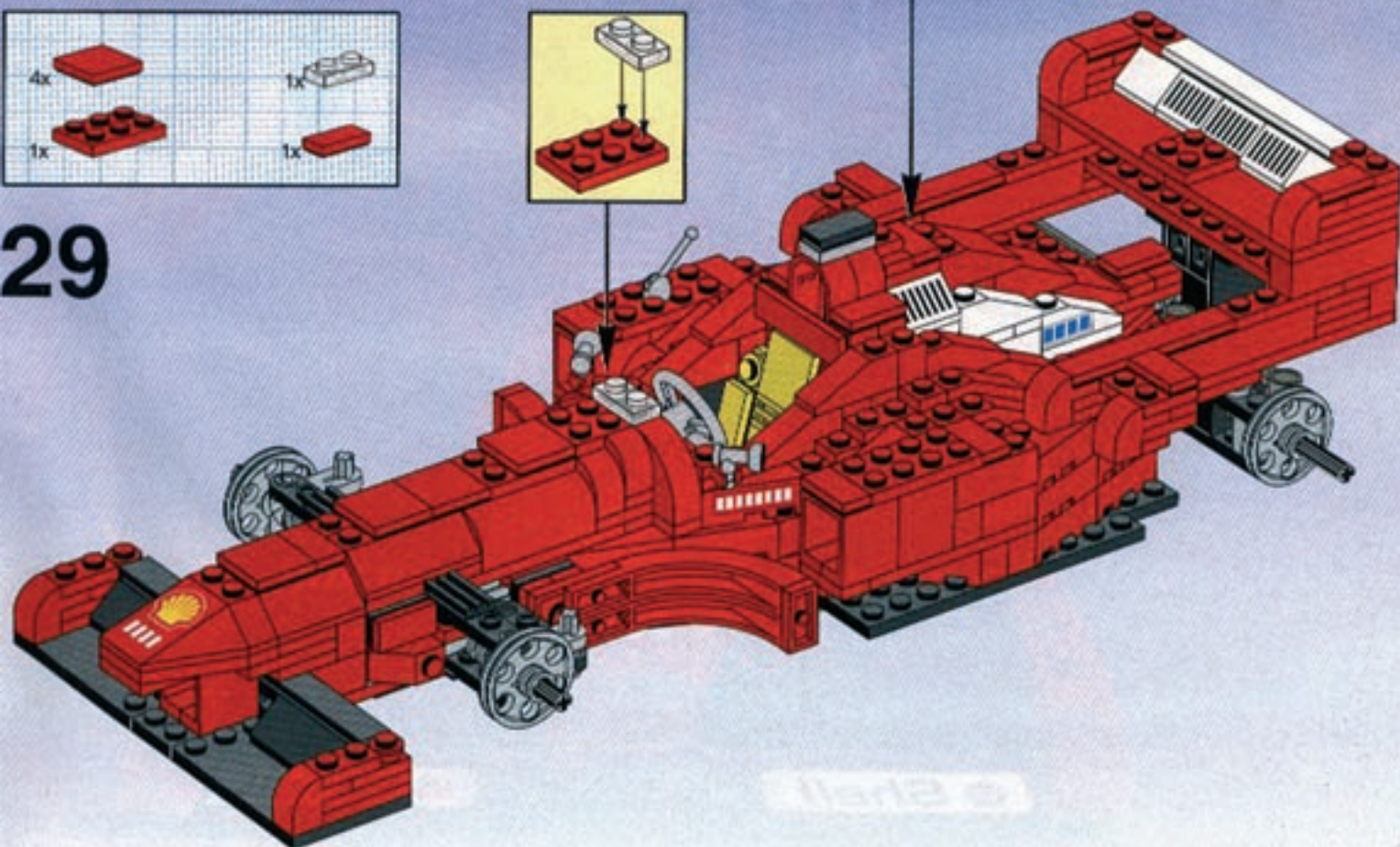



30

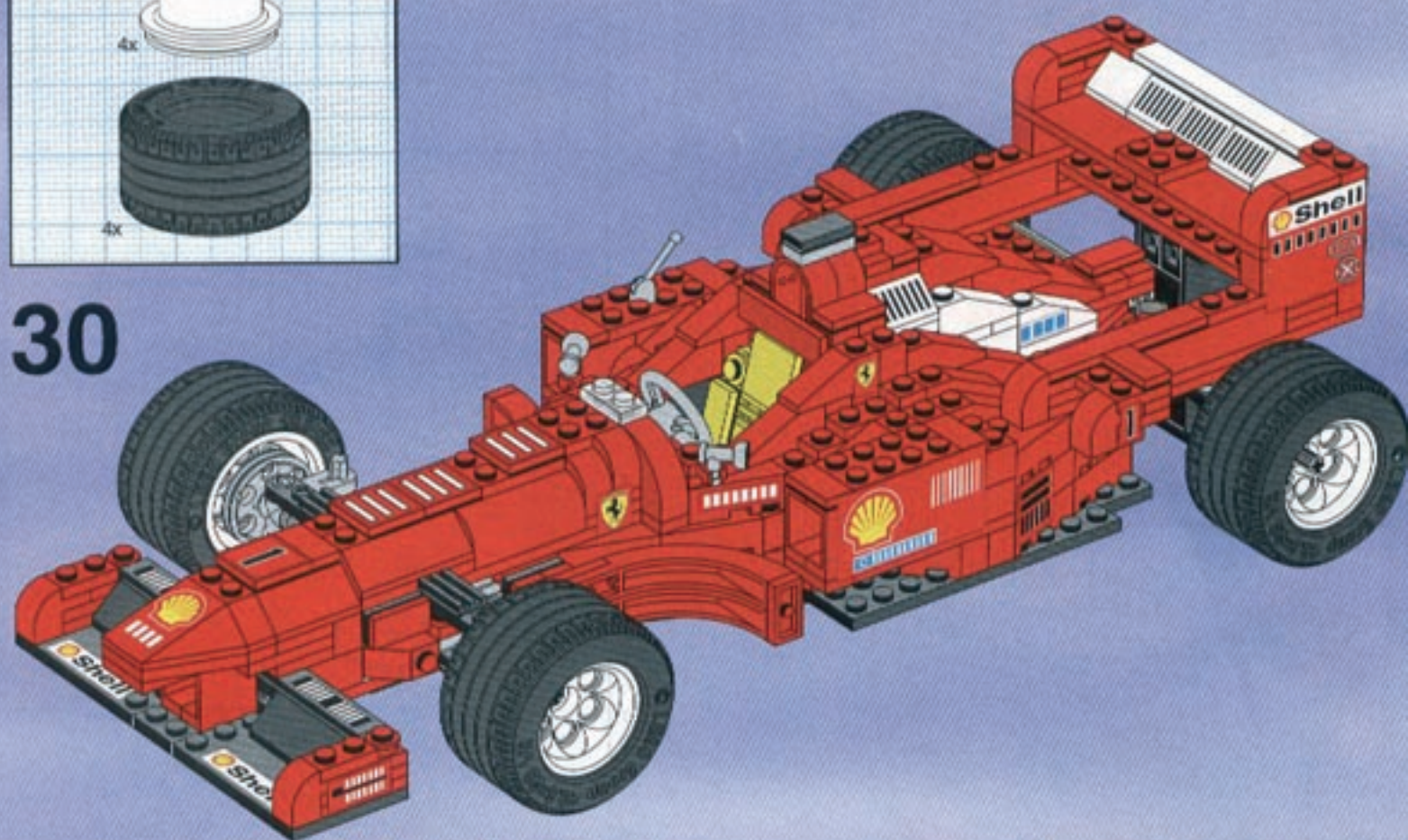

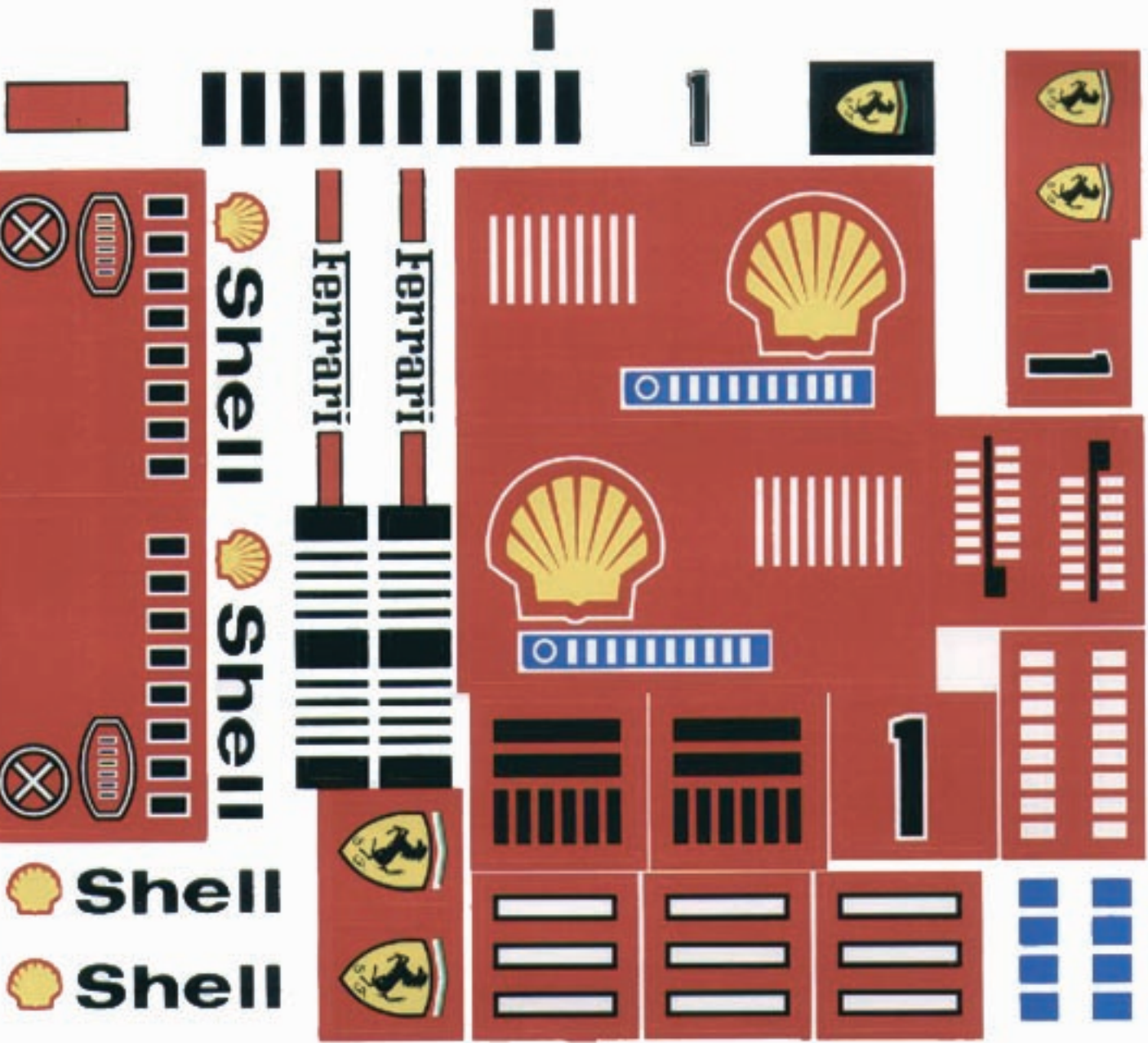

72535/4116/728 ©1998 LEGO GROUP

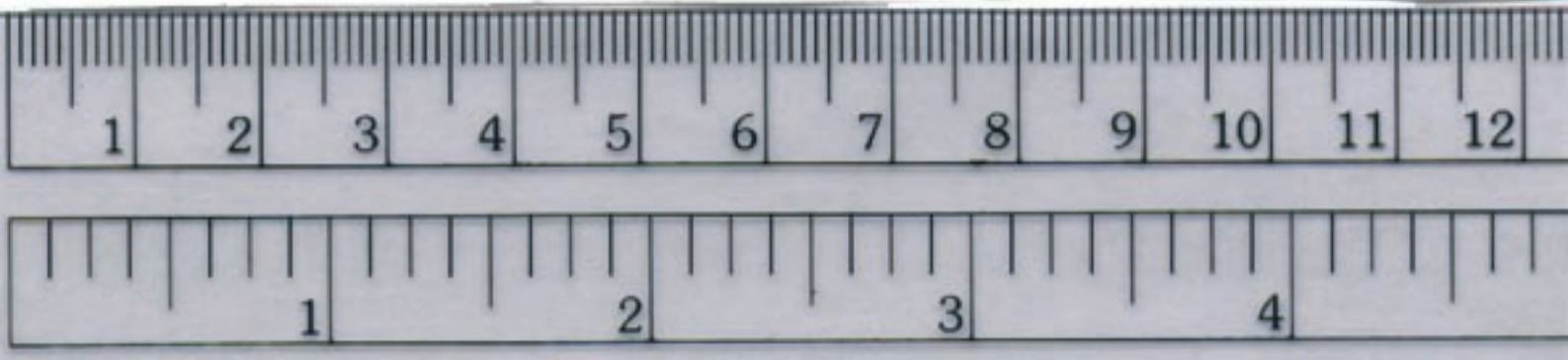

Image

Qty

Item No

Description

MID

Regular Items:

Parts:

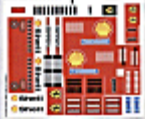
1 [2556stk01](#)**Sticker for Set 2556 - (72535/4116728)**Catalog: [Parts](#): [Sticker](#)

* !

2 [3004](#)**Black Brick 1 x 2**Catalog: [Parts](#): [Brick](#)

* !

4 [3622](#)**Black Brick 1 x 3**Catalog: [Parts](#): [Brick](#)

* !

1 [3008](#)**Black Brick 1 x 8**Catalog: [Parts](#): [Brick](#)

* !

2 [4070](#)**Black Brick, Modified 1 x 1 with Headlight**Catalog: [Parts](#): [Brick, Modified](#)

* !

1 [3937](#)**Black Hinge Brick 1 x 2 Base**Catalog: [Parts](#): [Hinge](#)

* !

1 [3938](#)**Black Hinge Brick 1 x 2 Top Plate Thin**Catalog: [Parts](#): [Hinge](#)

* !

2 [4864a](#)**Black Panel 1 x 2 x 2 - Solid Studs**Catalog: [Parts](#): [Panel](#)

* !

2 [3024](#)**Black Plate 1 x 1**Catalog: [Parts](#): [Plate](#)

* !

3 [3023](#)**Black Plate 1 x 2**Catalog: [Parts](#): [Plate](#)

* !

4 [3623](#)**Black Plate 1 x 3**Catalog: [Parts](#): [Plate](#)

* !



3 [3710](#)

Black Plate 1 x 4
[Catalog](#): [Parts](#): [Plate](#)

* !



2 [3666](#)

Black Plate 1 x 6
[Catalog](#): [Parts](#): [Plate](#)

* !



4 [3460](#)

Black Plate 1 x 8
[Catalog](#): [Parts](#): [Plate](#)

* !



2 [3022](#)

Black Plate 2 x 2
[Catalog](#): [Parts](#): [Plate](#)

* !



4 [2420](#)

Black Plate 2 x 2 Corner
[Catalog](#): [Parts](#): [Plate](#)

* !



1 [3021](#)

Black Plate 2 x 3
[Catalog](#): [Parts](#): [Plate](#)

* !



8 [3020](#)

Black Plate 2 x 4
[Catalog](#): [Parts](#): [Plate](#)

* !



4 [3795](#)

Black Plate 2 x 6
[Catalog](#): [Parts](#): [Plate](#)

* !



1 [3034](#)

Black Plate 2 x 8
[Catalog](#): [Parts](#): [Plate](#)

* !



2 [3832](#)

Black Plate 2 x 10
[Catalog](#): [Parts](#): [Plate](#)

* !



1 [3030](#)

Black Plate 4 x 10
[Catalog](#): [Parts](#): [Plate](#)

* !



1 [3958](#)

Black Plate 6 x 6
[Catalog](#): [Parts](#): [Plate](#)

* !



2 [3033](#)

Black Plate 6 x 10

Catalog: [Parts](#): [Plate](#)

* !

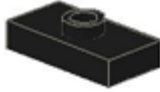

1 [3794](#)

Black Plate, Modified 1 x 2 with 1 Stud (Jumper)

Catalog: [Parts](#): [Plate, Modified](#)

* !



2 [3040](#)

Black Slope 45 2 x 1

Catalog: [Parts](#): [Slope](#)

* !



2 [3037](#)

Black Slope 45 2 x 4

Catalog: [Parts](#): [Slope](#)

* !



1 [4519](#)

Black Technic, Axle 3

Catalog: [Parts](#): [Technic, Axle](#)

* !



3 [3705](#)

Black Technic, Axle 4

Catalog: [Parts](#): [Technic, Axle](#)

* !



2 [3706](#)

Black Technic, Axle 6

Catalog: [Parts](#): [Technic, Axle](#)

* !



4 [3700](#)

Black Technic, Brick 1 x 2 with Hole

Catalog: [Parts](#): [Technic, Brick](#)

* !



2 [4263](#)

Black Technic, Plate 1 x 4 with Toothed Ends

Catalog: [Parts](#): [Technic, Plate](#)

* !



4 [4262](#)

Black Technic, Plate 1 x 6 with Toothed Ends

Catalog: [Parts](#): [Technic, Plate](#)

* !

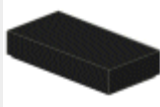

3 [3069b](#)

Black Tile 1 x 2 with Groove

Catalog: [Parts](#): [Tile](#)

* !



1 [2431](#)

Black Tile 1 x 4

Catalog: [Parts](#): [Tile](#)

* !



2 [6636](#)

Black Tile 1 x 6
[Catalog](#): [Parts](#): [Tile](#)

* !



6 [2412b](#)

Black Tile, Modified 1 x 2 Grille with Bottom Groove / Lip
[Catalog](#): [Parts](#): [Tile, Modified](#)

* !



2 [6180](#)

Black Tile, Modified 4 x 6 with Studs on Edges
[Catalog](#): [Parts](#): [Tile, Modified](#)

* !



4 [6594](#)

Black Tire 49.6 x 28 VR
[Catalog](#): [Parts](#): [Tire & Tread](#)

* !



1 [3933](#)

Black Wedge, Plate 8 x 4 Wing Left
[Catalog](#): [Parts](#): [Wedge, Plate](#)

* !

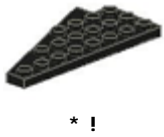

1 [3934](#)

Black Wedge, Plate 8 x 4 Wing Right
[Catalog](#): [Parts](#): [Wedge, Plate](#)

* !



1 [30046](#)

Black Window 1 x 2 x 2 2/3 Pane Lattice Diamond with Rounded Top
[Catalog](#): [Parts](#): [Window](#)

* !

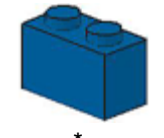

1 [3004](#)

Blue Brick 1 x 2
[Catalog](#): [Parts](#): [Brick](#)

*



2 [3622](#)

Blue Brick 1 x 3
[Catalog](#): [Parts](#): [Brick](#)

*

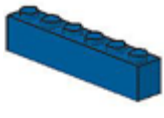

2 [3009](#)

Blue Brick 1 x 6
[Catalog](#): [Parts](#): [Brick](#)

* !



1 [6111](#)

Blue Brick 1 x 10
[Catalog](#): [Parts](#): [Brick](#)

* !

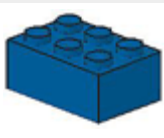

2 [3002](#)

Blue Brick 2 x 3
[Catalog](#): [Parts](#): [Brick](#)

* !



2 [6091](#)

Blue Brick, Modified 1 x 2 x 1 1/3 with Curved Top

Catalog: [Parts](#): [Brick, Modified](#)

* !



2 [3937](#)

Blue Hinge Brick 1 x 2 Base

Catalog: [Parts](#): [Hinge](#)

*



6 [3023](#)

Blue Plate 1 x 2

Catalog: [Parts](#): [Plate](#)

*



2 [3623](#)

Blue Plate 1 x 3

Catalog: [Parts](#): [Plate](#)

*

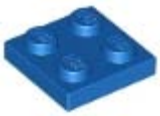

2 [3022](#)

Blue Plate 2 x 2

Catalog: [Parts](#): [Plate](#)

*

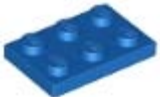

3 [3021](#)

Blue Plate 2 x 3

Catalog: [Parts](#): [Plate](#)

*



1 [3020](#)

Blue Plate 2 x 4

Catalog: [Parts](#): [Plate](#)

*



2 [3040](#)

Blue Slope 45 2 x 1

Catalog: [Parts](#): [Slope](#)

*



2 [3070b](#)

Blue Tile 1 x 1 with Groove

Catalog: [Parts](#): [Tile](#)

* !



2 [2739b](#)

Dark Gray Technic, Link 1 x 6 with Stoppers

Catalog: [Parts](#): [Technic, Link](#)

* !



2 [3957](#)

Light Gray Antenna 1 x 4

Catalog: [Parts](#): [Antenna](#)

* !



2 [3010](#)

Light Gray Brick 1 x 4

Catalog: [Parts](#): [Brick](#)

* !



1 [3008](#)

Light Gray Brick 1 x 8

Catalog: [Parts: Brick](#)

*

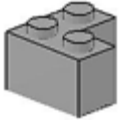

2 [2357](#)

Light Gray Brick 2 x 2 Corner

Catalog: [Parts: Brick](#)

* !



4 [4070](#)

Light Gray Brick, Modified 1 x 1 with Headlight

Catalog: [Parts: Brick, Modified](#)

*



4 [3062b](#)

Light Gray Brick, Round 1 x 1 Open Stud

Catalog: [Parts: Brick, Round](#)

* !



1 [4592c03](#) (Inv) **Light Gray Lever Small Base with Light Gray Lever**

Catalog: [Parts: Lever](#)

*

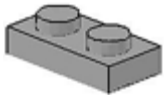

2 [3023](#)

Light Gray Plate 1 x 2

Catalog: [Parts: Plate](#)

*



4 [3710](#)

Light Gray Plate 1 x 4

Catalog: [Parts: Plate](#)

*



2 [3666](#)

Light Gray Plate 1 x 6

Catalog: [Parts: Plate](#)

*



2 [3460](#)

Light Gray Plate 1 x 8

Catalog: [Parts: Plate](#)

*

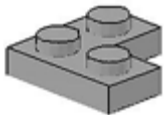

4 [2420](#)

Light Gray Plate 2 x 2 Corner

Catalog: [Parts: Plate](#)

*



2 [3021](#)

Light Gray Plate 2 x 3

Catalog: [Parts: Plate](#)

*



2 [3020](#)

Light Gray Plate 2 x 4

Catalog: [Parts: Plate](#)

*



1 [3832](#)

Light Gray Plate 2 x 10

Catalog: [Parts](#): [Plate](#)

*



1 [3036](#)

Light Gray Plate 6 x 8

Catalog: [Parts](#): [Plate](#)

* !

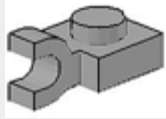

4 [6019](#)

Light Gray Plate, Modified 1 x 1 with Clip Horizontal (thick open U clip)

Catalog: [Parts](#): [Plate, Modified](#)

* !

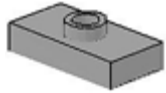

4 [3794](#)

Light Gray Plate, Modified 1 x 2 with 1 Stud (Jumper)

Catalog: [Parts](#): [Plate, Modified](#)

*

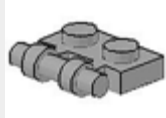

2 [2540](#)

Light Gray Plate, Modified 1 x 2 with Handle on Side - Free Ends

Catalog: [Parts](#): [Plate, Modified](#)

* !

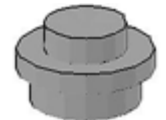

22 [4073](#)

Light Gray Plate, Round 1 x 1 Straight Side

Catalog: [Parts](#): [Plate, Round](#)

* !



2 [4599a](#)

NEW Light Gray Tap 1 x 1 with Hole in End

Catalog: [Parts](#): [Tap](#)

*



2 [3713](#)

Light Gray Technic Bush

Catalog: [Parts](#): [Technic](#)

* !



9 [4265c](#)

Light Gray Technic Bush 1/2 Smooth

Catalog: [Parts](#): [Technic](#)

* !



4 [4185](#)

Light Gray Technic Wedge Belt Wheel (Pulley)

Catalog: [Parts](#): [Technic](#)

* !



2 [3749](#)

Light Gray Technic, Axle Pin without Friction Ridges Lengthwise

Catalog: [Parts](#): [Technic, Axle](#)

* !



6 [6541](#)

Light Gray Technic, Brick 1 x 1 with Hole

Catalog: [Parts](#): [Technic, Brick](#)

* !

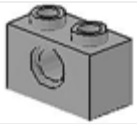

2 [3700](#)

Light Gray Technic, Brick 1 x 2 with Hole

Catalog: [Parts: Technic, Brick](#)

*



1 [3647](#)

Light Gray Technic, Gear 8 Tooth Type 1

Catalog: [Parts: Technic, Gear](#)

* !

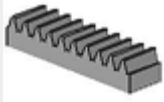

1 [3743](#)

Light Gray Technic, Gear Rack 1 x 4

Catalog: [Parts: Technic, Gear](#)

* !



2 [4274](#)

Light Gray Technic, Pin 1/2

Catalog: [Parts: Technic, Pin](#)

* !



2 [4261](#)

Light Gray Technic, Steering Arm

Catalog: [Parts: Technic, Steering](#)

* !



1 [2819](#)

Light Gray Technic, Steering Wheel Small, 3 Studs Diameter

Catalog: [Parts: Technic, Steering](#)

* !



1 [9244c01](#) (Inv)

Light Gray Technic, Universal Joint 4L

Catalog: [Parts: Technic, Connector](#)

*



2 [2431](#)

Light Gray Tile 1 x 4

Catalog: [Parts: Tile](#)

*



2 [3068b](#)

Light Gray Tile 2 x 2 with Groove

Catalog: [Parts: Tile](#)

* !

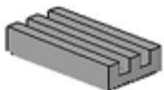

3 [2412b](#)

Light Gray Tile, Modified 1 x 2 Grille with Bottom Groove / Lip

Catalog: [Parts: Tile, Modified](#)

*



4 [3005](#)

Red Brick 1 x 1

Catalog: [Parts: Brick](#)

* !

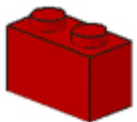

9 [3004](#)

Red Brick 1 x 2

Catalog: [Parts: Brick](#)

*



2 [3010](#)

Red Brick 1 x 4
[Catalog](#): [Parts](#): [Brick](#)

*



4 [3009](#)

Red Brick 1 x 6
[Catalog](#): [Parts](#): [Brick](#)

*



1 [3003](#)

Red Brick 2 x 2
[Catalog](#): [Parts](#): [Brick](#)

* !



10 [2357](#)

Red Brick 2 x 2 Corner
[Catalog](#): [Parts](#): [Brick](#)

*



4 [3002](#)

Red Brick 2 x 3
[Catalog](#): [Parts](#): [Brick](#)

*



2 [6005](#)

Red Brick, Arch 1 x 3 x 2 Curved Top
[Catalog](#): [Parts](#): [Brick](#), [Arch](#)

* !



4 [6060](#)

Red Brick, Arch 1 x 6 x 3 1/3 Curved Top
[Catalog](#): [Parts](#): [Brick](#), [Arch](#)

* !



4 [4070](#)

Red Brick, Modified 1 x 1 with Headlight
[Catalog](#): [Parts](#): [Brick](#), [Modified](#)

*



14 [6091](#)

Red Brick, Modified 1 x 2 x 1 1/3 with Curved Top
[Catalog](#): [Parts](#): [Brick](#), [Modified](#)

*



2 [6081](#)

Red Brick, Modified 2 x 4 x 1 1/3 with Curved Top
[Catalog](#): [Parts](#): [Brick](#), [Modified](#)

* !



2 [2462](#)

Red Brick, Modified Facet 3 x 3
[Catalog](#): [Parts](#): [Brick](#), [Modified](#)

* !



2 [3063](#)

Red Brick, Round Corner 2 x 2 Macaroni with Stud Notch
[Catalog](#): [Parts](#): [Brick](#), [Round](#)

* !



10 [4864a](#)

Red Panel 1 x 2 x 2 - Solid Studs

[Catalog](#): [Parts](#): [Panel](#)

*



9 [3024](#)

Red Plate 1 x 1

[Catalog](#): [Parts](#): [Plate](#)

*

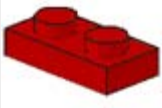

36 [3023](#)

Red Plate 1 x 2

[Catalog](#): [Parts](#): [Plate](#)

*



24 [3623](#)

Red Plate 1 x 3

[Catalog](#): [Parts](#): [Plate](#)

*



5 [3710](#)

Red Plate 1 x 4

[Catalog](#): [Parts](#): [Plate](#)

*



4 [3666](#)

Red Plate 1 x 6

[Catalog](#): [Parts](#): [Plate](#)

*



2 [4477](#)

Red Plate 1 x 10

[Catalog](#): [Parts](#): [Plate](#)

* !



4 [3022](#)

Red Plate 2 x 2

[Catalog](#): [Parts](#): [Plate](#)

*

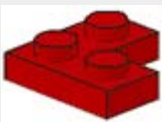

16 [2420](#)

Red Plate 2 x 2 Corner

[Catalog](#): [Parts](#): [Plate](#)

*



6 [3021](#)

Red Plate 2 x 3

[Catalog](#): [Parts](#): [Plate](#)

*



6 [3020](#)

Red Plate 2 x 4

[Catalog](#): [Parts](#): [Plate](#)

*



3 [3795](#)

Red Plate 2 x 6

[Catalog](#): [Parts](#): [Plate](#)

*



2 [2445](#)

Red Plate 2 x 12
[Catalog](#): [Parts](#): [Plate](#)

* !

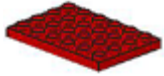

3 [3032](#)

Red Plate 4 x 6
[Catalog](#): [Parts](#): [Plate](#)

* !



2 [4085c](#)

Red Plate, Modified 1 x 1 with Clip Vertical - Type 3 (thick U clip)
[Catalog](#): [Parts](#): [Plate, Modified](#)

* !



3 [3794](#)

Red Plate, Modified 1 x 2 with 1 Stud (Jumper)
[Catalog](#): [Parts](#): [Plate, Modified](#)

*

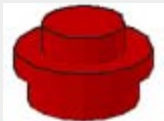

2 [4073](#)

Red Plate, Round 1 x 1 Straight Side
[Catalog](#): [Parts](#): [Plate, Round](#)

*



14 [4286](#)

Red Slope 33 3 x 1
[Catalog](#): [Parts](#): [Slope](#)

* !



3 [3298](#)

Red Slope 33 3 x 2
[Catalog](#): [Parts](#): [Slope](#)

* !



2 [3040](#)

Red Slope 45 2 x 1
[Catalog](#): [Parts](#): [Slope](#)

*



2 [3038](#)

Red Slope 45 2 x 3
[Catalog](#): [Parts](#): [Slope](#)

* !



2 [3037](#)

Red Slope 45 2 x 4
[Catalog](#): [Parts](#): [Slope](#)

*



2 [3665](#)

Red Slope, Inverted 45 2 x 1
[Catalog](#): [Parts](#): [Slope, Inverted](#)

* !



2 [6541](#)

Red Technic, Brick 1 x 1 with Hole
[Catalog](#): [Parts](#): [Technic, Brick](#)

*



19 [3069b](#)

Red Tile 1 x 2 with Groove

[Catalog](#): [Parts](#): [Tile](#)

*



1 [2431](#)

Red Tile 1 x 4

[Catalog](#): [Parts](#): [Tile](#)

*

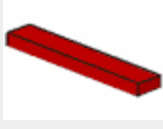

4 [6636](#)

Red Tile 1 x 6

[Catalog](#): [Parts](#): [Tile](#)

*



4 [3068b](#)

Red Tile 2 x 2 with Groove

[Catalog](#): [Parts](#): [Tile](#)

*



2 [6180](#)

Red Tile, Modified 4 x 6 with Studs on Edges

[Catalog](#): [Parts](#): [Tile, Modified](#)

*

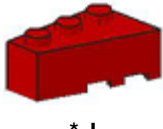

9 [6565](#)

Red Wedge 3 x 2 Left

[Catalog](#): [Parts](#): [Wedge](#)

* !



9 [6564](#)

Red Wedge 3 x 2 Right

[Catalog](#): [Parts](#): [Wedge](#)

* !



1 [6069pb04](#)

Red Wedge 4 x 4 Triple without Stud Notches with Shell Logo Pattern

[Catalog](#): [Parts](#): [Wedge, Decorated](#)

*



1 [4859](#)

Red Wedge, Plate 3 x 4 without Stud Notches

[Catalog](#): [Parts](#): [Wedge, Plate](#)

* !

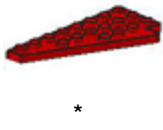

1 [3933](#)

Red Wedge, Plate 8 x 4 Wing Left

[Catalog](#): [Parts](#): [Wedge, Plate](#)

*



1 [3934](#)

Red Wedge, Plate 8 x 4 Wing Right

[Catalog](#): [Parts](#): [Wedge, Plate](#)

*



2 [30044](#)

Red Window 1 x 2 x 2 2/3 with Rounded Top

[Catalog](#): [Parts](#): [Window](#)

* !

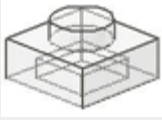

1 [3024](#)

Trans-Clear Plate 1 x 1

[Catalog](#): [Parts](#): [Plate](#)

*



1 [3023](#)

Trans-Clear Plate 1 x 2

[Catalog](#): [Parts](#): [Plate](#)

*

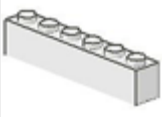

2 [3009](#)

White Brick 1 x 6

[Catalog](#): [Parts](#): [Brick](#)

*



1 [3001](#)

White Brick 2 x 4

[Catalog](#): [Parts](#): [Brick](#)

* !

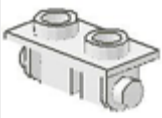

2 [3938](#)

White Hinge Brick 1 x 2 Top Plate Thin

[Catalog](#): [Parts](#): [Hinge](#)

*

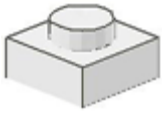

1 [3024](#)

White Plate 1 x 1

[Catalog](#): [Parts](#): [Plate](#)

*



2 [3623](#)

White Plate 1 x 3

[Catalog](#): [Parts](#): [Plate](#)

*



1 [3710](#)

White Plate 1 x 4

[Catalog](#): [Parts](#): [Plate](#)

*



1 [3020](#)

White Plate 2 x 4

[Catalog](#): [Parts](#): [Plate](#)

*



1 [3031](#)

White Plate 4 x 4

[Catalog](#): [Parts](#): [Plate](#)

* !

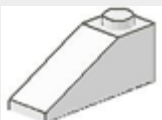

4 [4286](#)

White Slope 33 3 x 1

[Catalog](#): [Parts](#): [Slope](#)

*

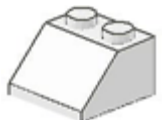

2 [3039](#)

White Slope 45 2 x 2

[Catalog](#): [Parts](#): [Slope](#)

* !

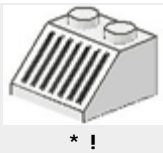

5 [3039p05](#)

White Slope 45 2 x 2 with Black Grille Pattern

Catalog: [Parts](#): [Slope_Decorated](#)

* !



1 [4162](#)

White Tile 1 x 8

Catalog: [Parts](#): [Tile](#)

* !



4 [6595](#)

White Wheel 36.8mm D. x 26mm VR with Axle Hole

Catalog: [Parts](#): [Wheel](#)

* !

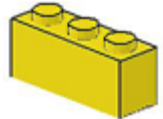

2 [3622](#)

Yellow Brick 1 x 3

Catalog: [Parts](#): [Brick](#)

*



2 [4275](#)

Yellow Hinge Plate 1 x 2 with 3 Fingers

Catalog: [Parts](#): [Hinge](#)

* !

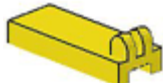

2 [4531](#)

Yellow Hinge Tile 1 x 2 1/2 with 2 Fingers on Top

Catalog: [Parts](#): [Hinge](#)

* !



2 [3023](#)

Yellow Plate 1 x 2

Catalog: [Parts](#): [Plate](#)

*



2 [3623](#)

Yellow Plate 1 x 3

Catalog: [Parts](#): [Plate](#)

*



1 [3710](#)

Yellow Plate 1 x 4

Catalog: [Parts](#): [Plate](#)

*



1 [3022](#)

Yellow Plate 2 x 2

Catalog: [Parts](#): [Plate](#)

*



2 [2420](#)

Yellow Plate 2 x 2 Corner

Catalog: [Parts](#): [Plate](#)

*

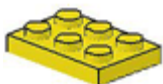

1 [3021](#)

Yellow Plate 2 x 3

Catalog: [Parts](#): [Plate](#)

*



2 [3020](#)

Yellow Plate 2 x 4

Catalog: [Parts](#): [Plate](#)

*



1 [3795](#)

Yellow Plate 2 x 6

Catalog: [Parts](#): [Plate](#)

*



2 [4073](#)

Yellow Plate, Round 1 x 1 Straight Side

Catalog: [Parts](#): [Plate](#), [Round](#)

*

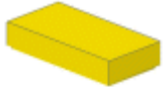

3 [3069b](#)

Yellow Tile 1 x 2 with Groove

Catalog: [Parts](#): [Tile](#)

*



2 [3068b](#)

Yellow Tile 2 x 2 with Groove

Catalog: [Parts](#): [Tile](#)

*



2 [2412b](#)

Yellow Tile, Modified 1 x 2 Grille with Bottom Groove / Lip

Catalog: [Parts](#): [Tile](#), [Modified](#)

*

Extra Items:

Parts:



1 [3070b](#)

Blue Tile 1 x 1 with Groove

Catalog: [Parts](#): [Tile](#)

*



1 [4592c03](#) (Inv)

Light Gray Lever Small Base with Light Gray Lever

Catalog: [Parts](#): [Lever](#)

*

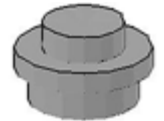

1 [4073](#)

Light Gray Plate, Round 1 x 1 Straight Side

Catalog: [Parts](#): [Plate](#), [Round](#)

*



1 [3713](#)

Light Gray Technic Bush

Catalog: [Parts](#): [Technic](#)

*



1 [4265c](#)

Light Gray Technic Bush 1/2 Smooth

Catalog: [Parts](#): [Technic](#)

*

Light Gray Technic, Pin 1/2



1 [4274](#)

Catalog: [Parts](#): [Technic_Pin](#)

*



1 [4073](#)

Red Plate, Round 1 x 1 Straight Side

Catalog: [Parts](#): [Plate_Round](#)

*



1 [4073](#)

Yellow Plate, Round 1 x 1 Straight Side

Catalog: [Parts](#): [Plate_Round](#)

*

Counterparts:

Parts:



1 [6180pb003](#)

Black Tile, Modified 4 x 6 with Studs on Edges with Shell Logo & Text Pattern (Sticker) - Set 2556

Catalog: [Parts](#): [Tile_Modified_Decorated](#)

*



2 [2431pb001](#)

Light Gray Tile 1 x 4 with 'Ferrari' and Red Stripes on White Background Pattern (Sticker) - Set 2556

Catalog: [Parts](#): [Tile_Decorated](#)

*



3 [3068bpb0066](#)

Red Tile 2 x 2 with 3 White Bars with Black Outline on Red Pattern (Sticker) - Set 2556

Catalog: [Parts](#): [Tile_Decorated](#)

*



1 [4286pb007L](#)

White Slope 33 3 x 1 with 4 Blue Squares Pattern Model Left (Sticker) - Set 2556

Catalog: [Parts](#): [Slope_Decorated](#)

*



1 [4286pb007R](#)

White Slope 33 3 x 1 with 4 Blue Squares Pattern Model Right (Sticker) - Set 2556

Catalog: [Parts](#): [Slope_Decorated](#)

*



4 [6595c02](#) ([Inv](#))

White Wheel 49.6 x 28 VR with Axle Hole, with Black Tire 49.6 x 28 VR (6595 / 6594)

Catalog: [Parts](#): [Wheel & Tire Assembly](#)

*

Summary:

Type	Unique Lots	Total Qty
Regular Items:		
Parts	173	580
Extra Items:		
Parts	8	8
Counterparts:		
Parts	6	12
New Items:		
Parts	1	2

[Yanitzch \(857\)](#)  inventoried this Set on Jun 9, 2003, inventory last updated on Jul 18, 2016.