

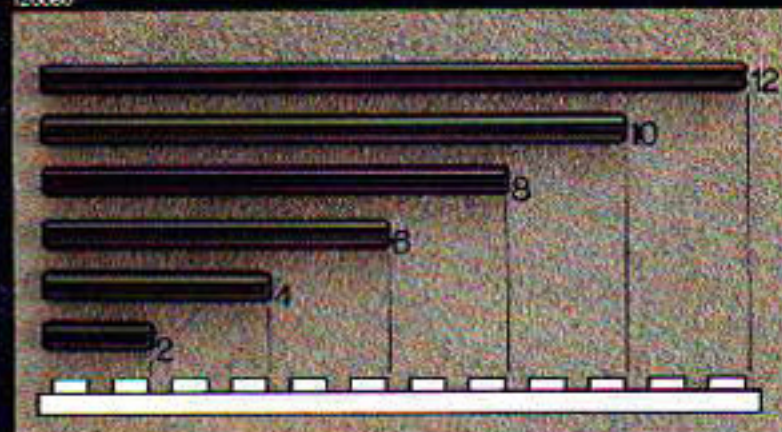

120060



In der Bauanleitung steht vor den Achsen eine Zahl, die die benötigte Länge der Achsen anzeigt.

Numbers in the building instructions near axles show the length of axle to be used.

Dans les conseils de construction, il y a un chiffre à côté de chaque axe. Ce chiffre indique la longueur des axes à utiliser.

Ut for akslerne i byggeanvisningen er anført et tal som viser hvilken aksellengde som skal brukes.

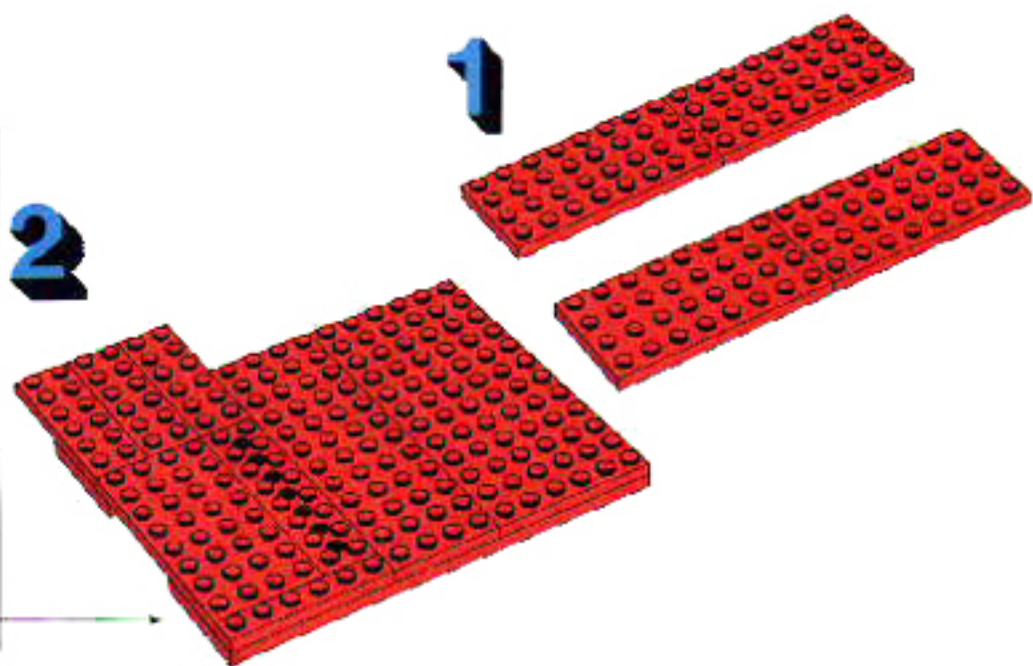
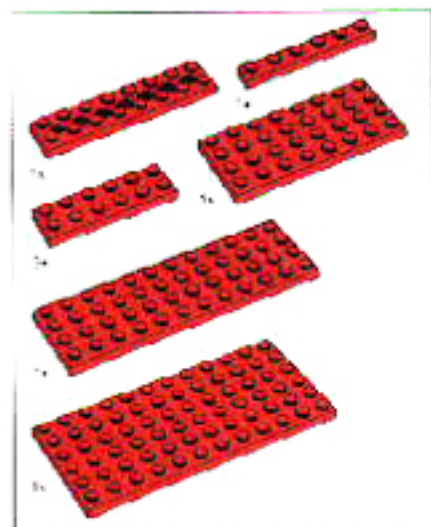



3

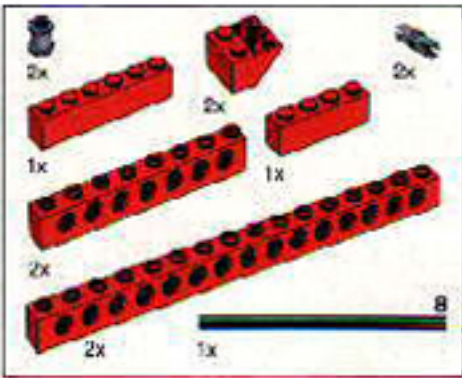
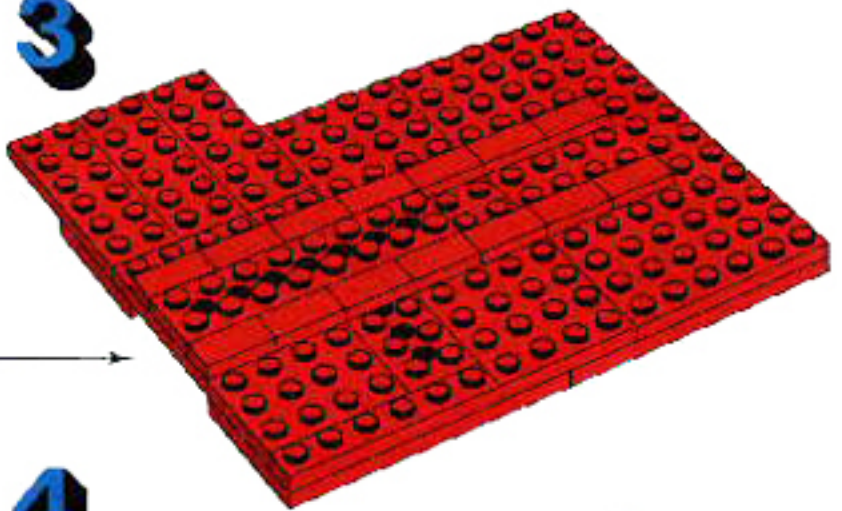

4

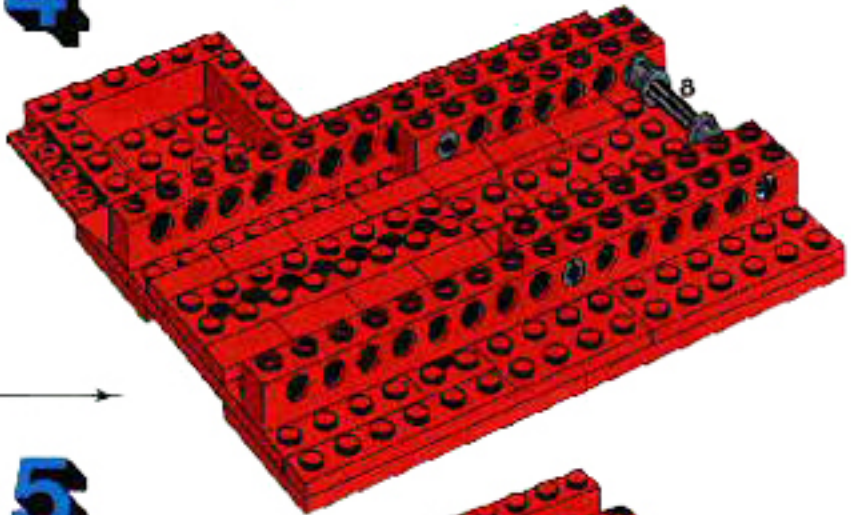

5

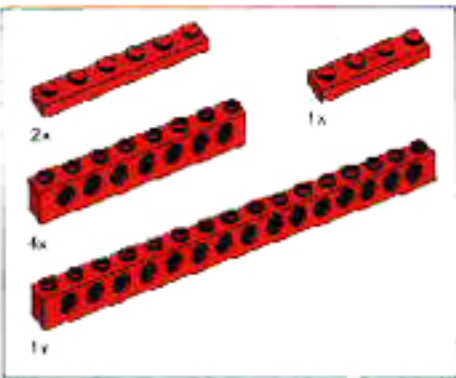
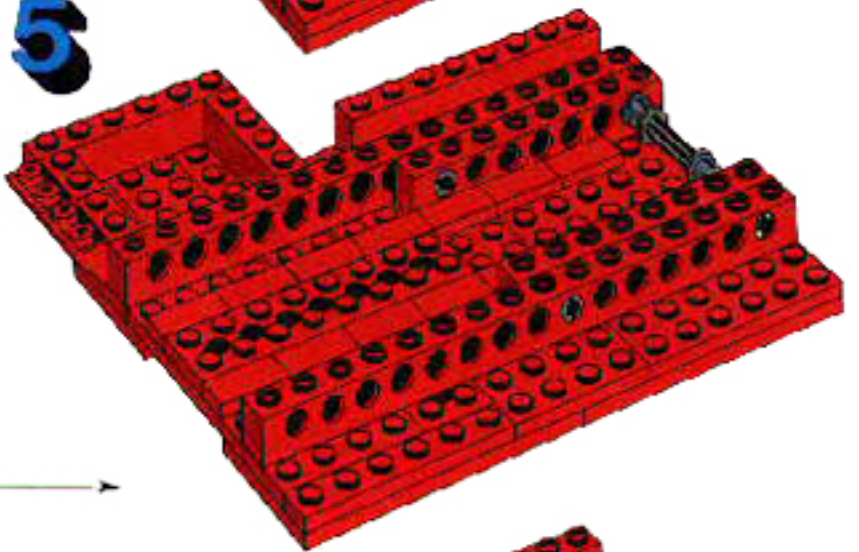

6

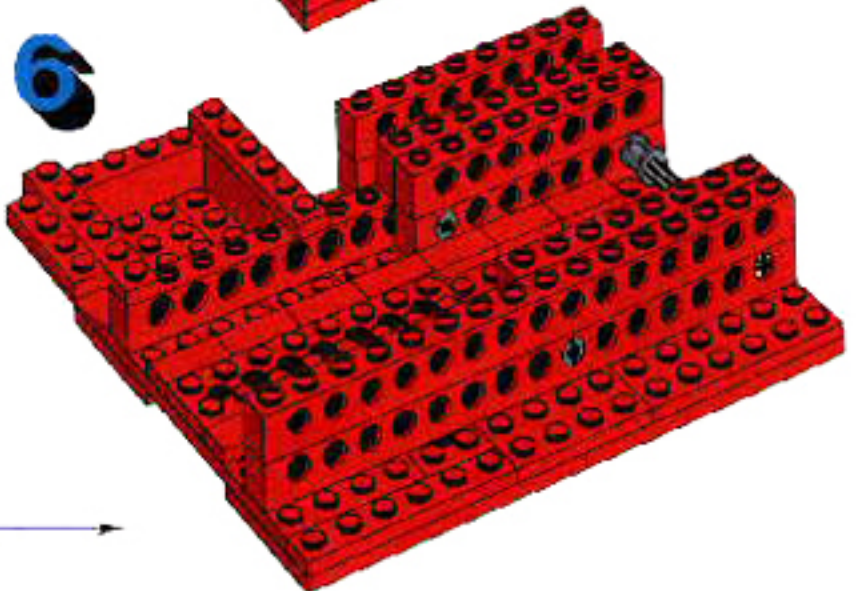

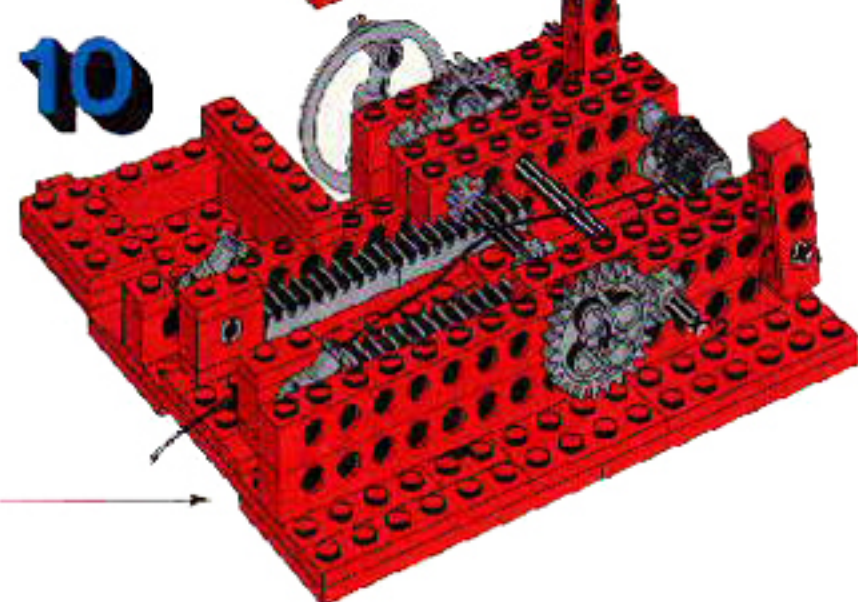
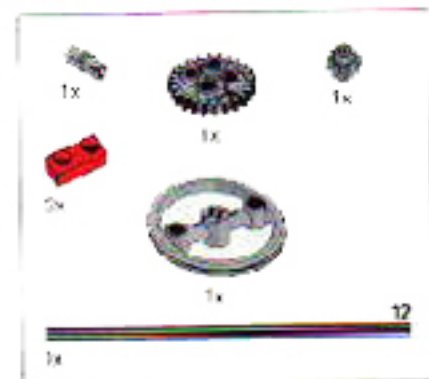
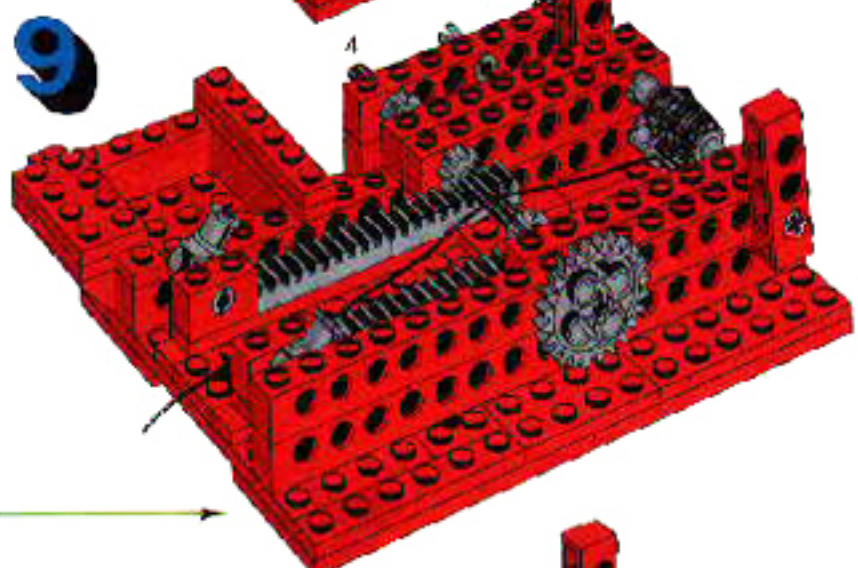
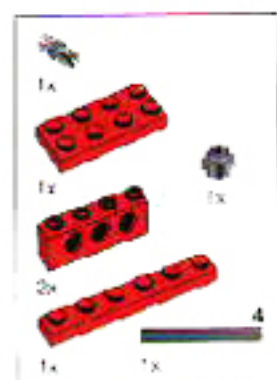
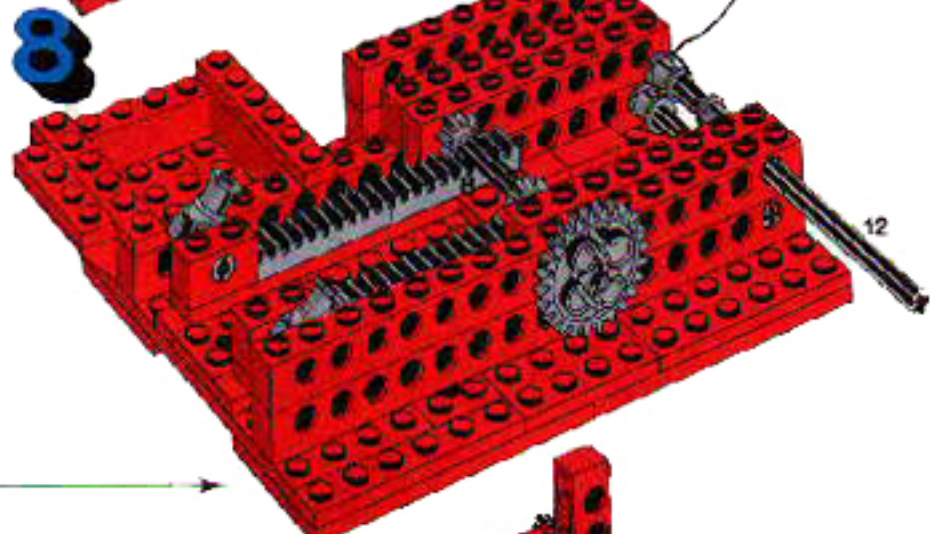
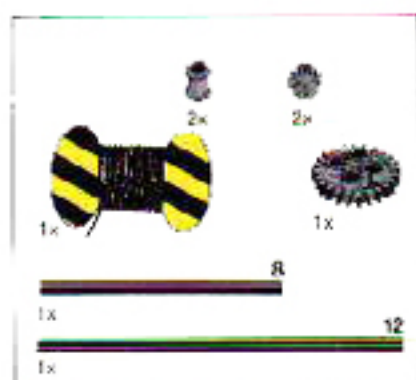

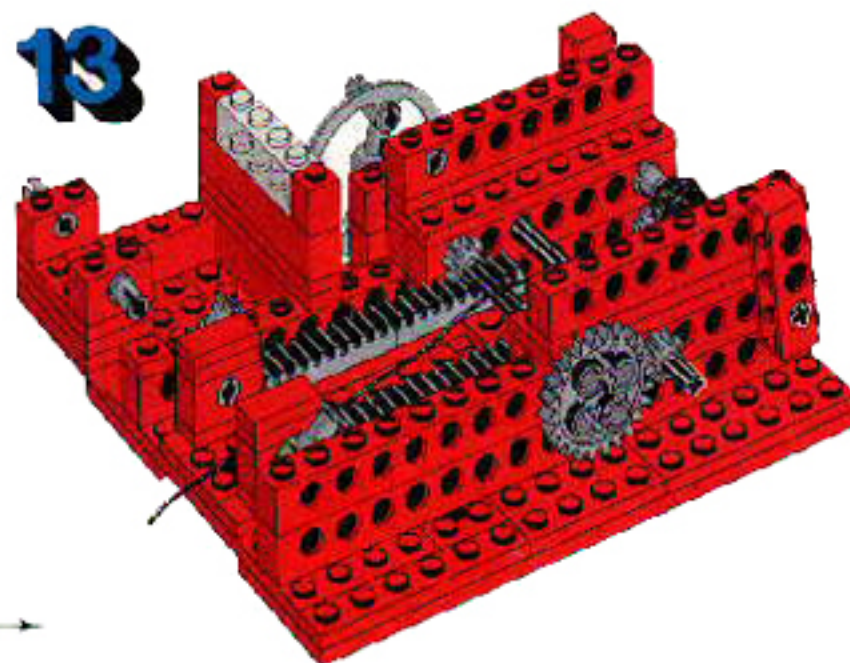
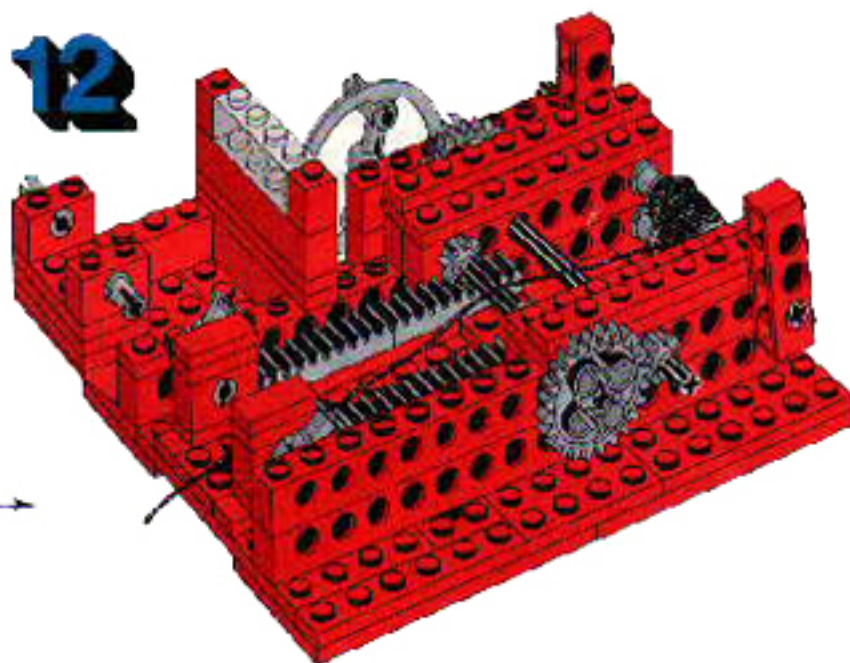
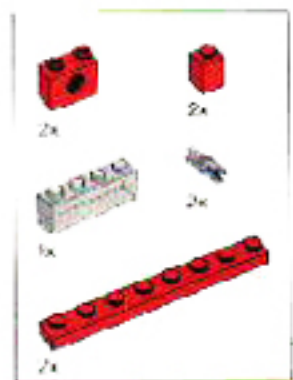
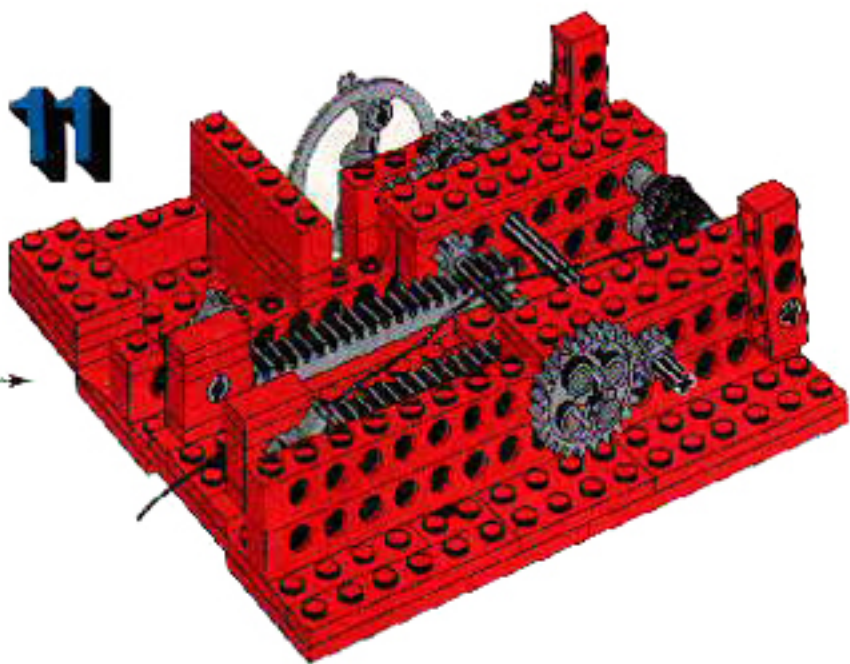
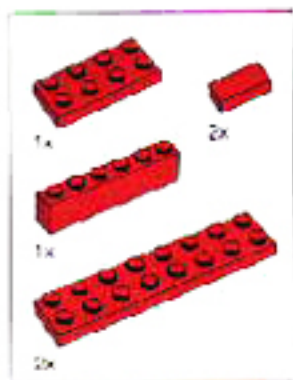

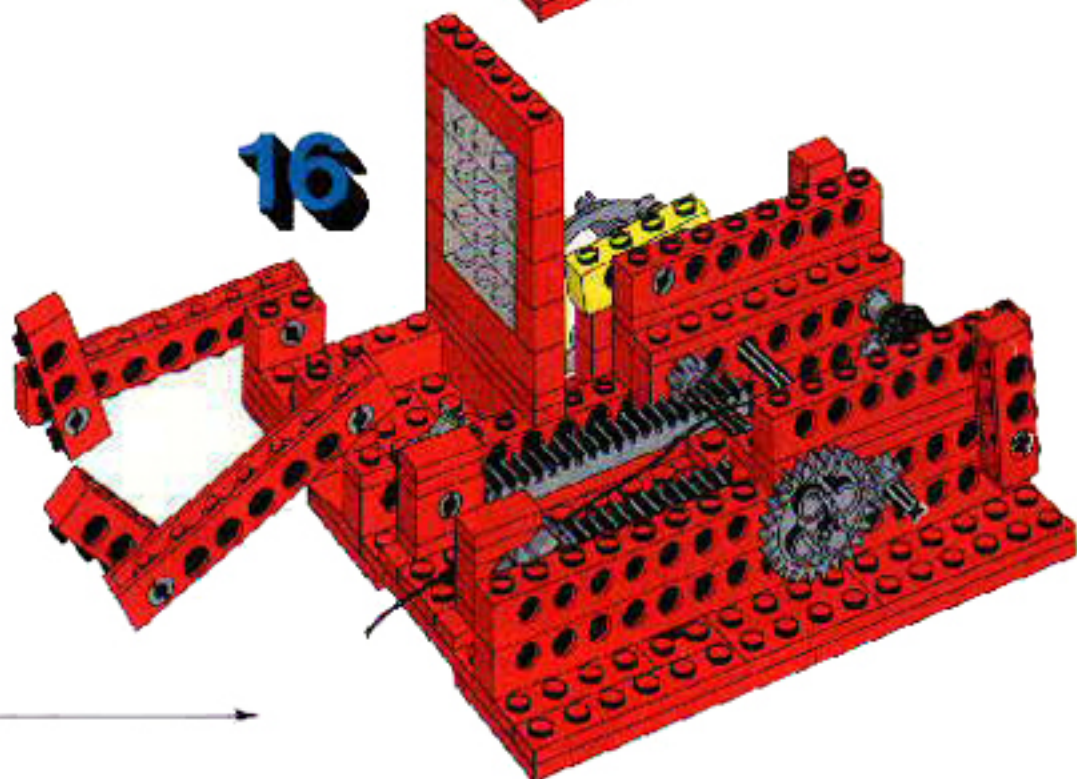
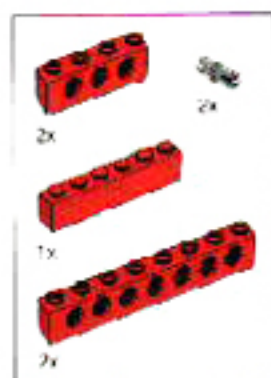
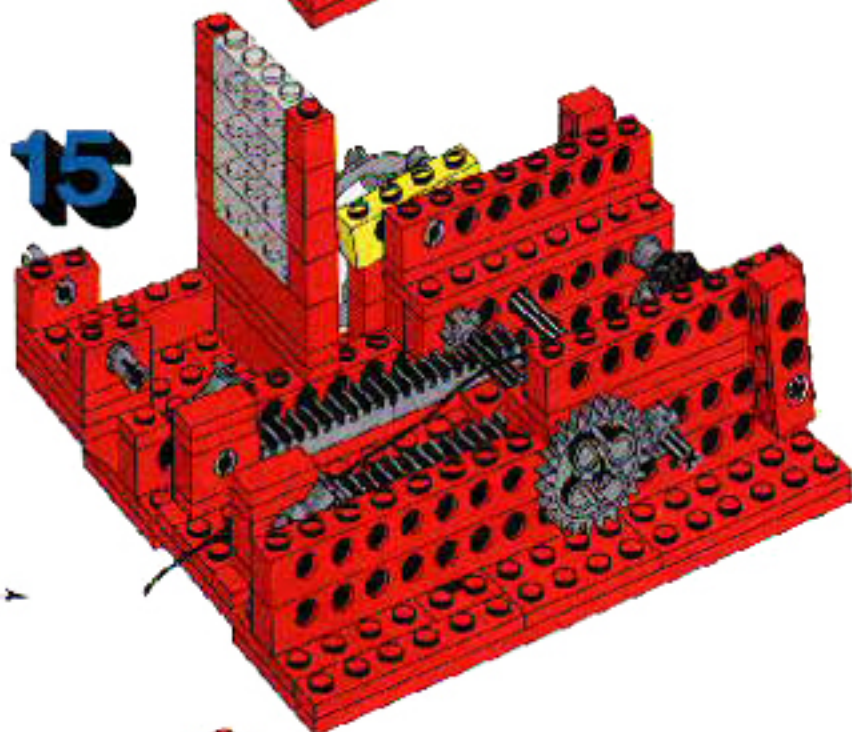
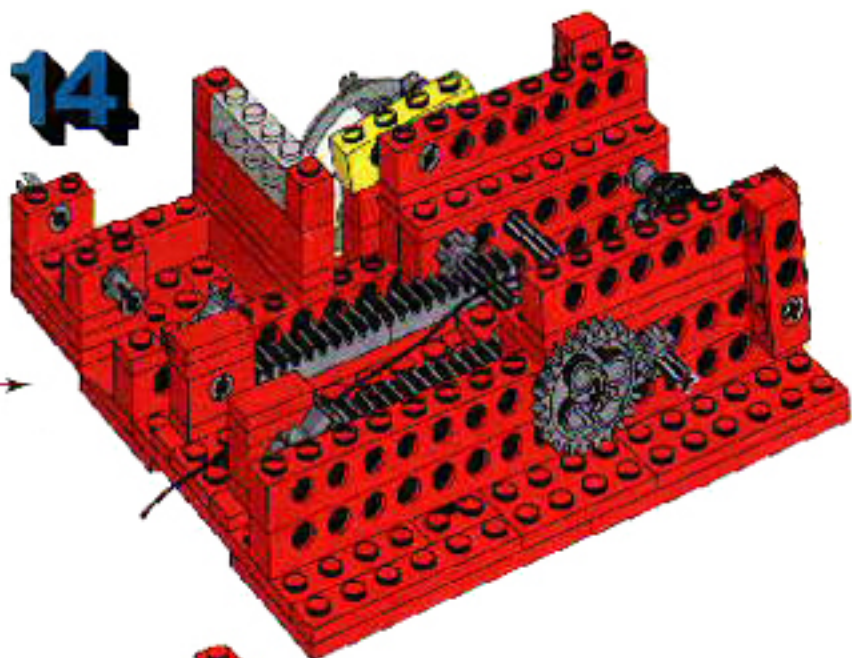

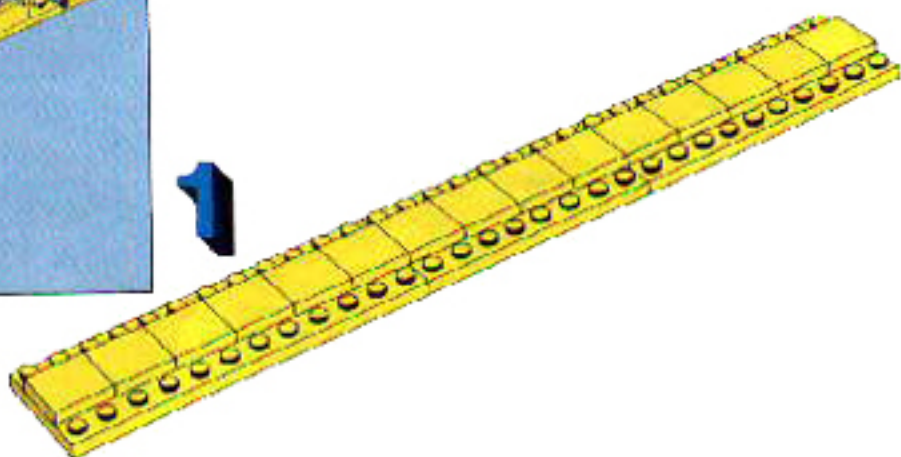
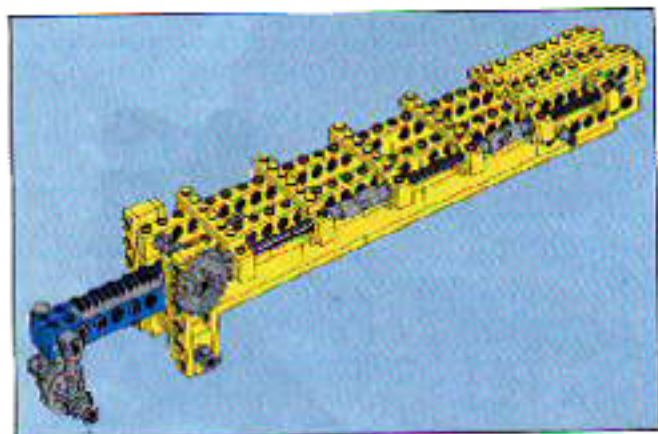
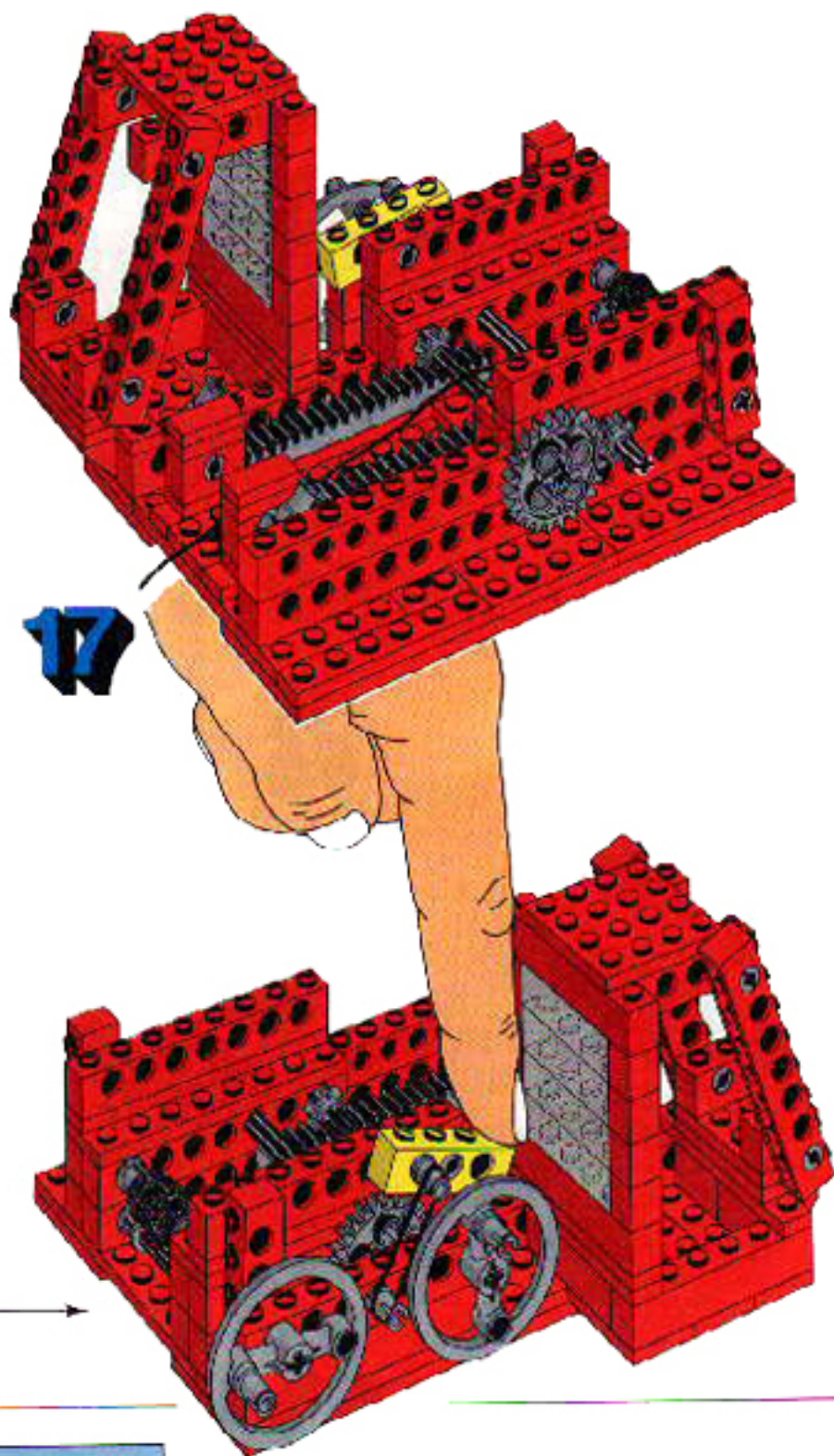

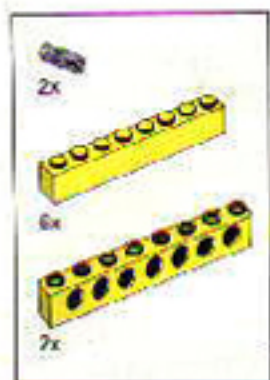

2

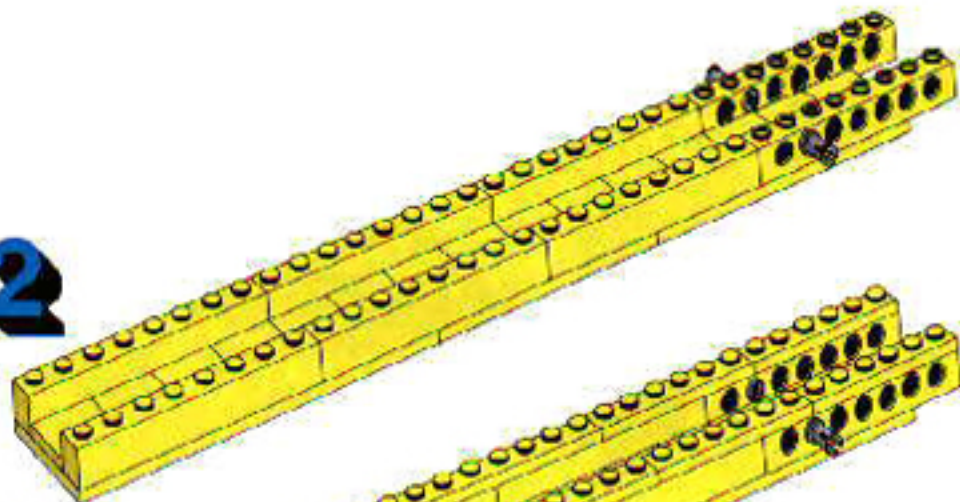

3

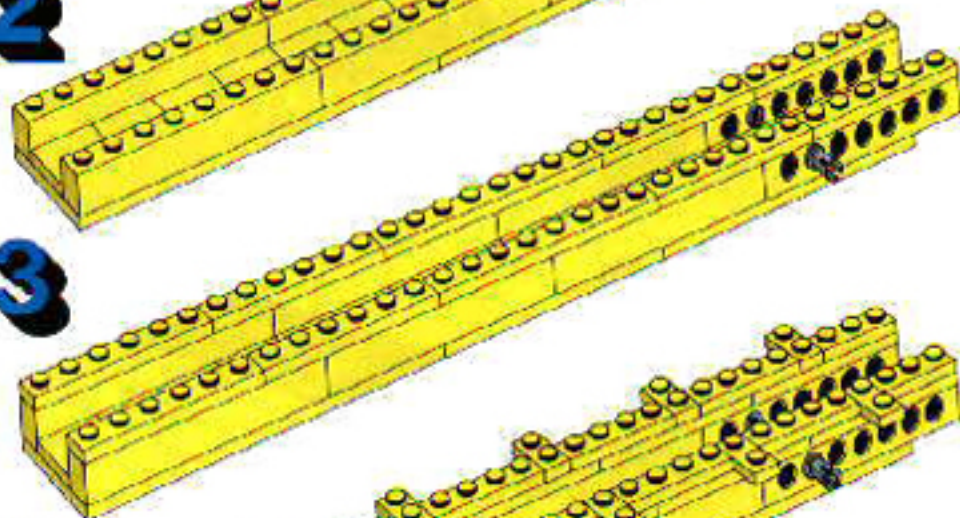

4

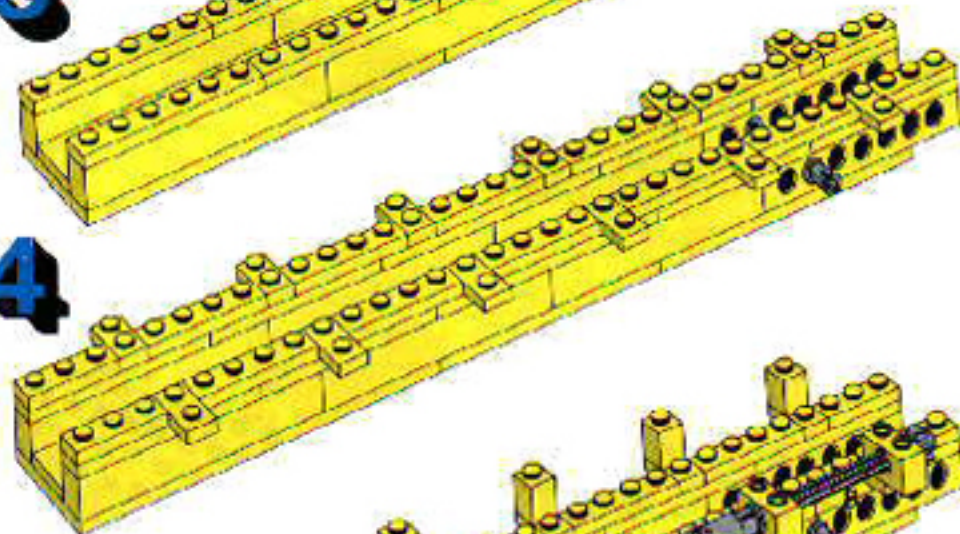

5

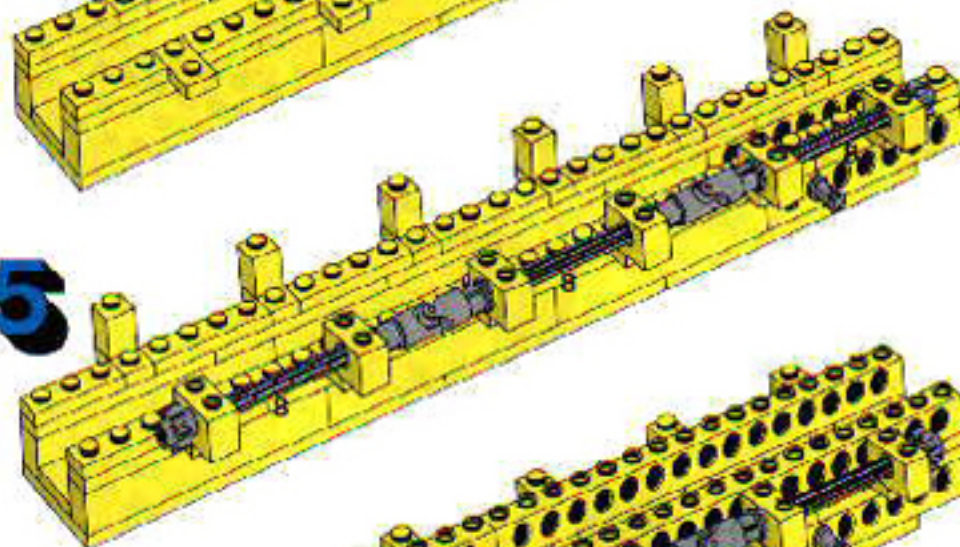

6

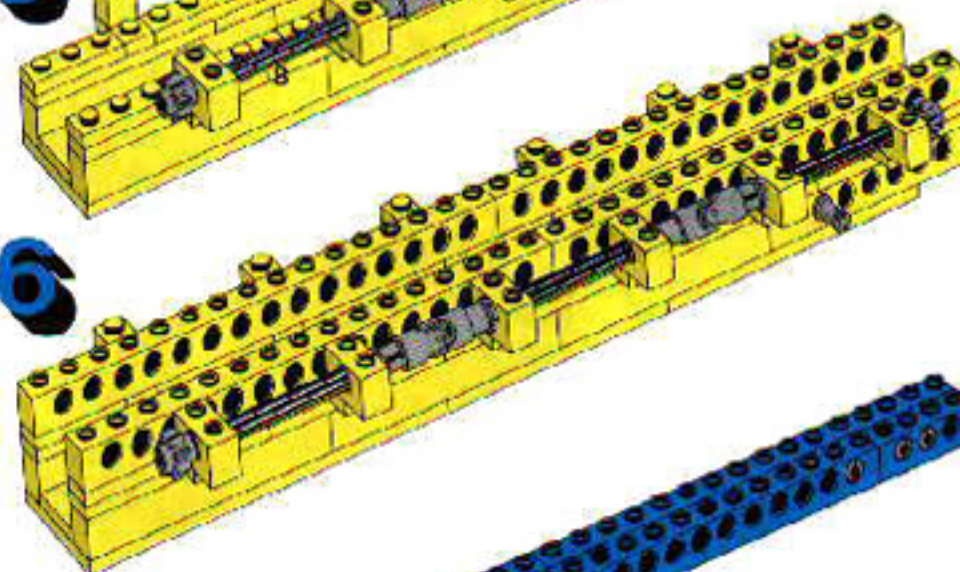

7



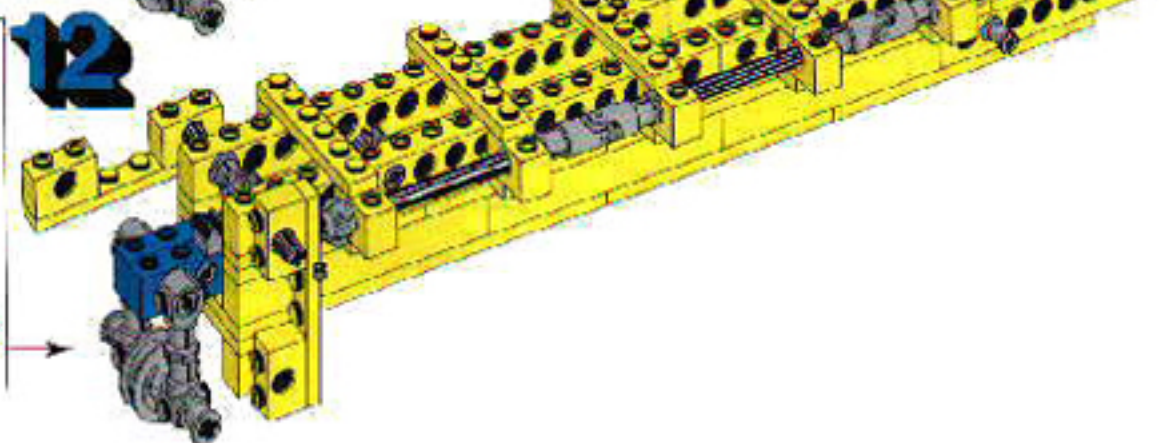
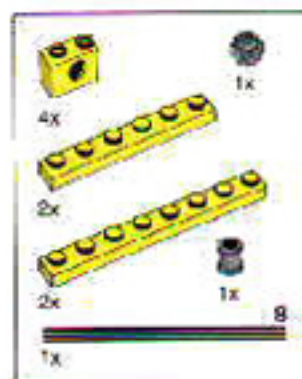
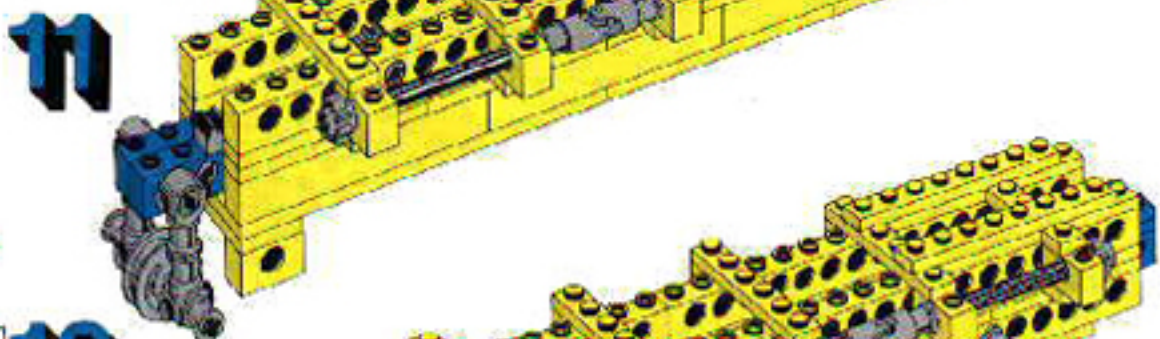
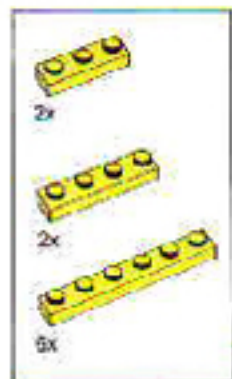
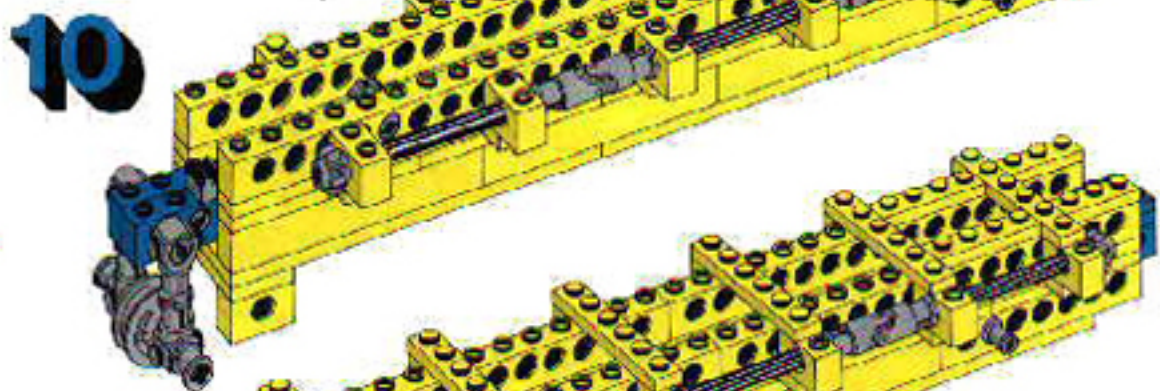



13

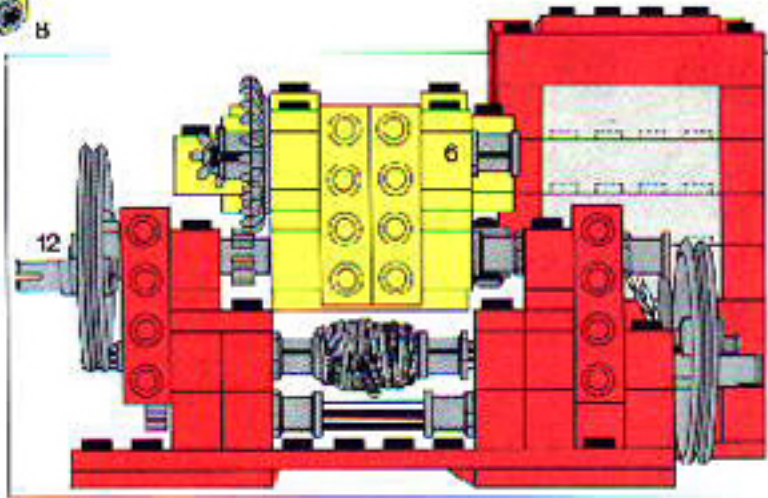
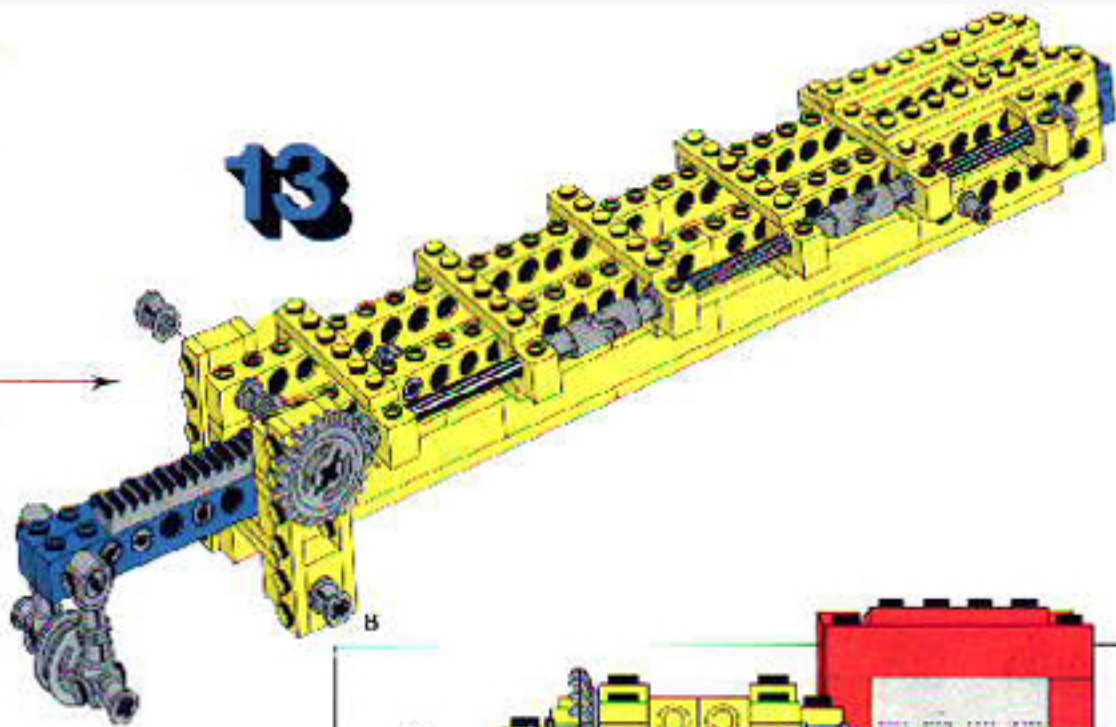

14

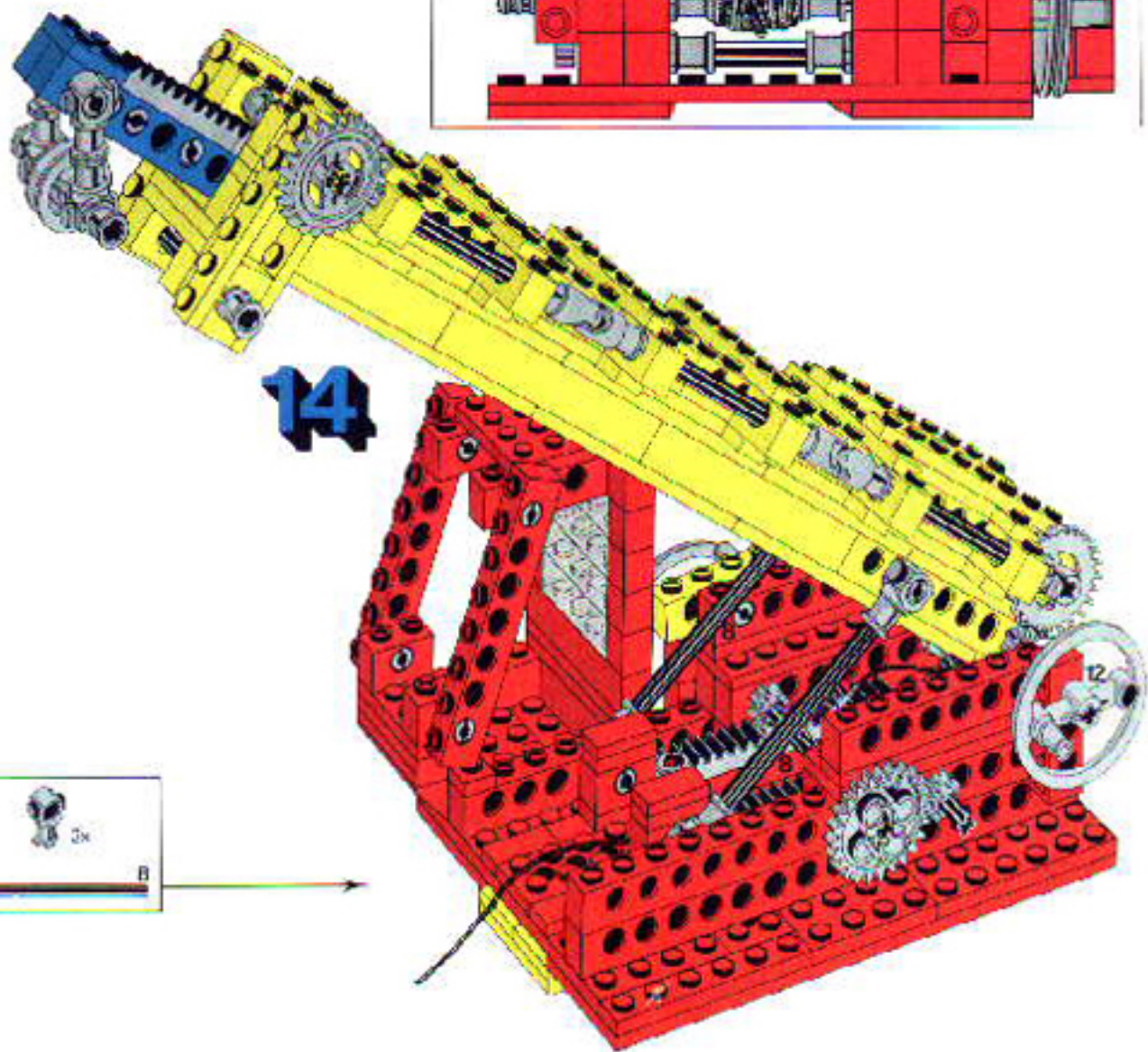

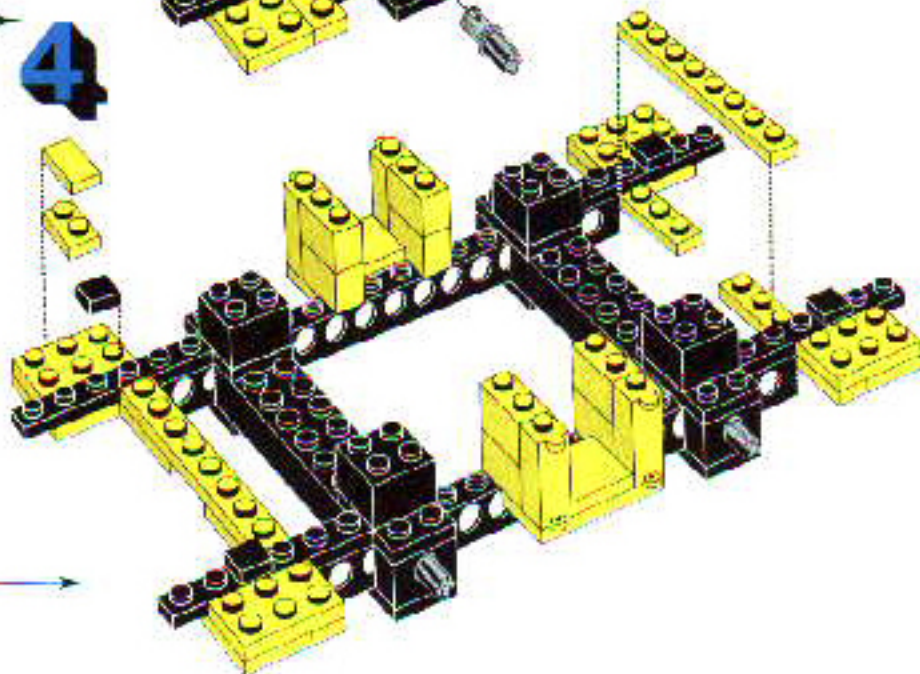
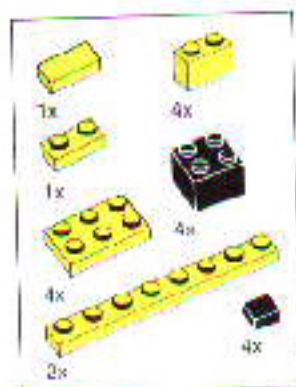
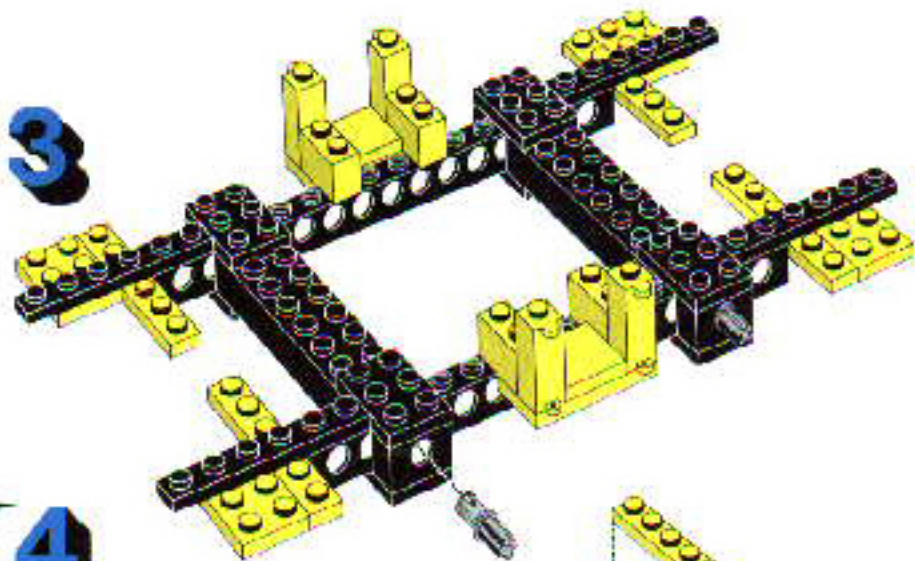
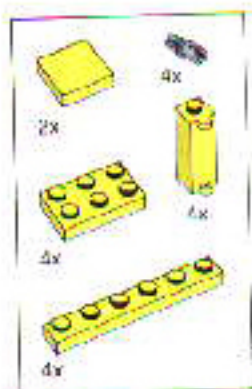
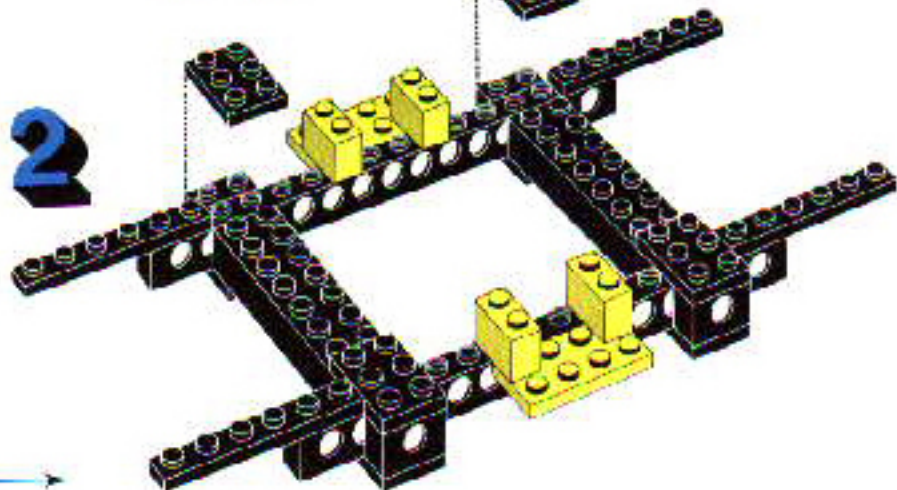
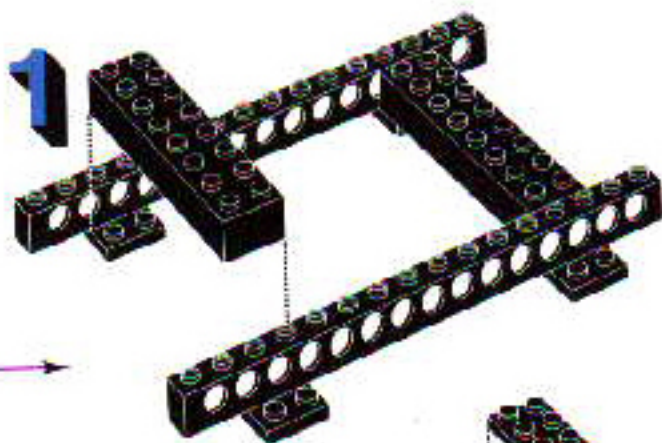
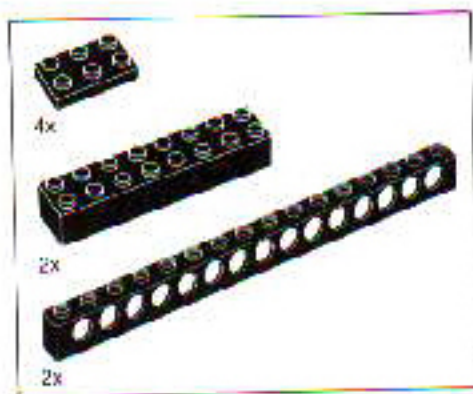

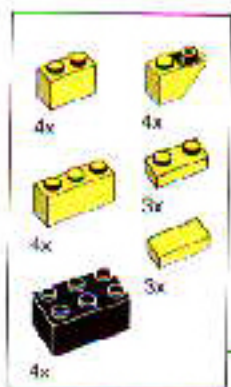

5

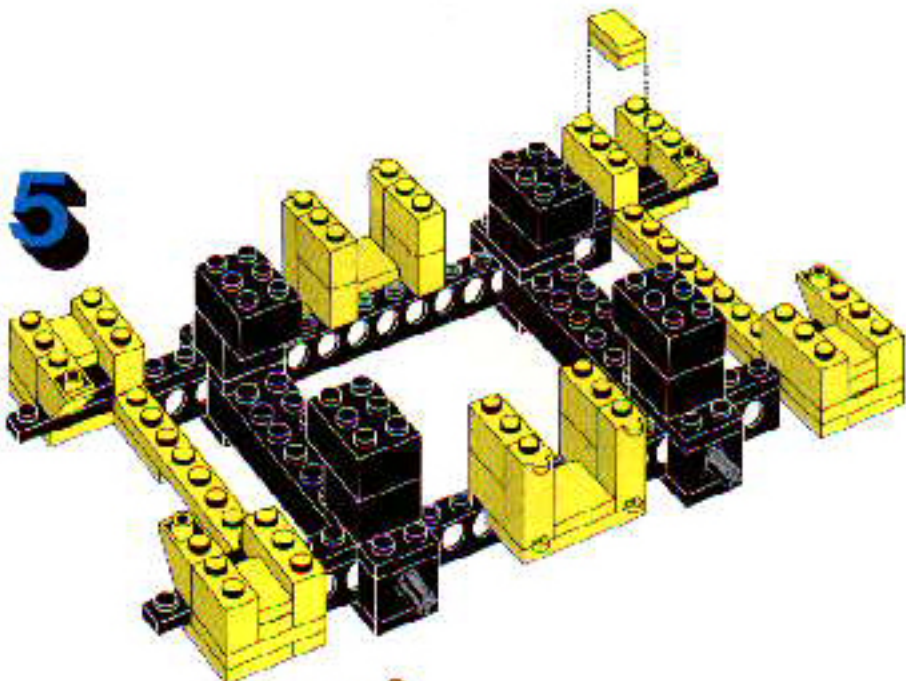

6

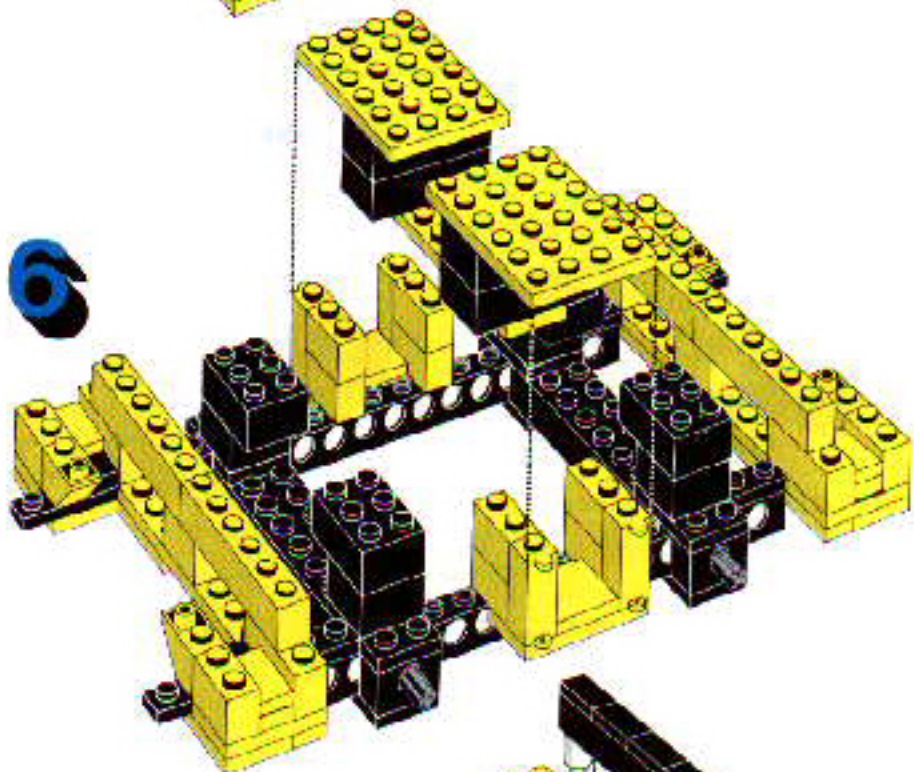

7

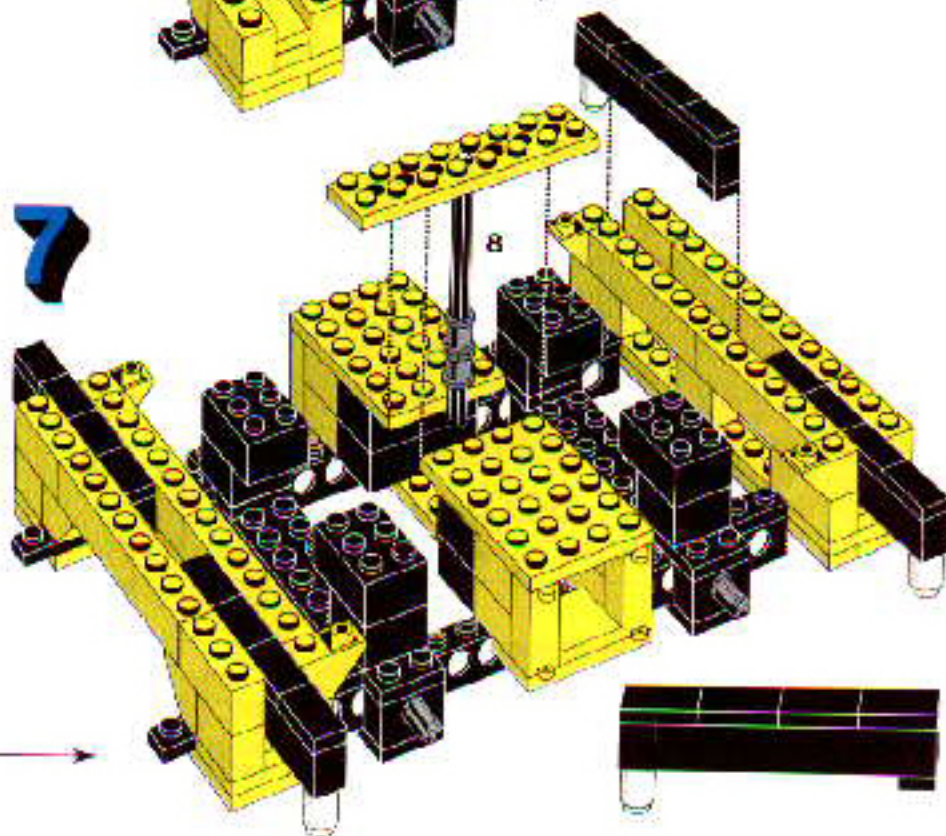

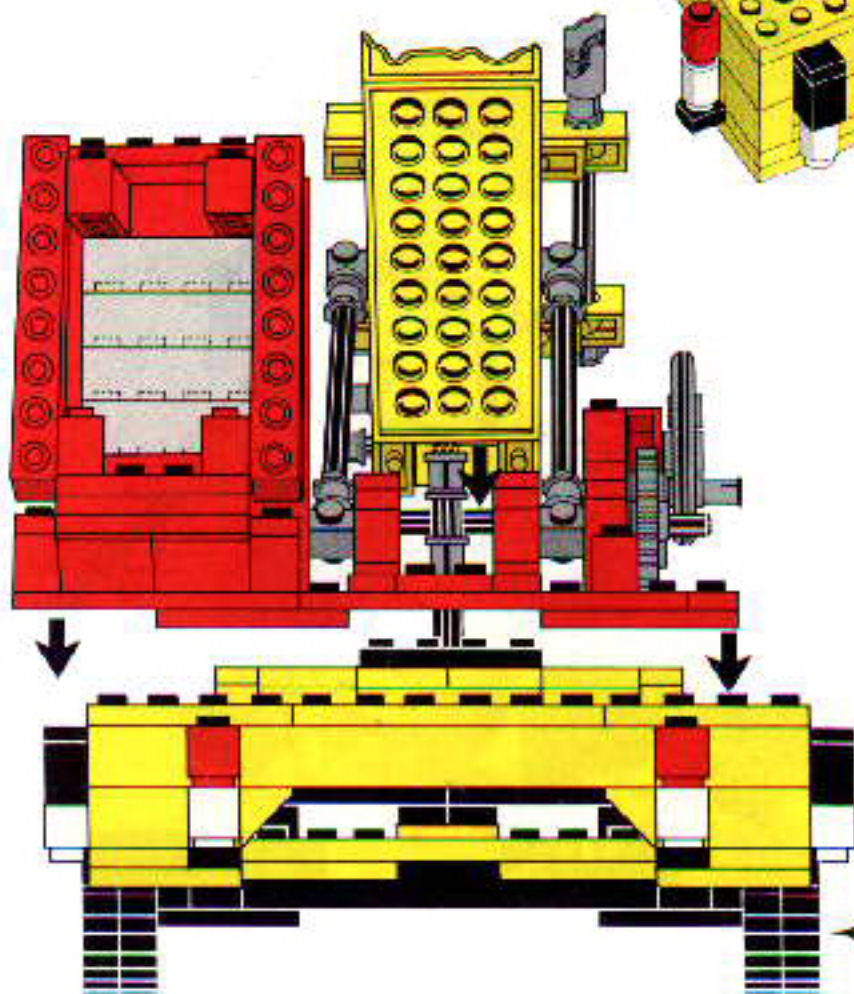
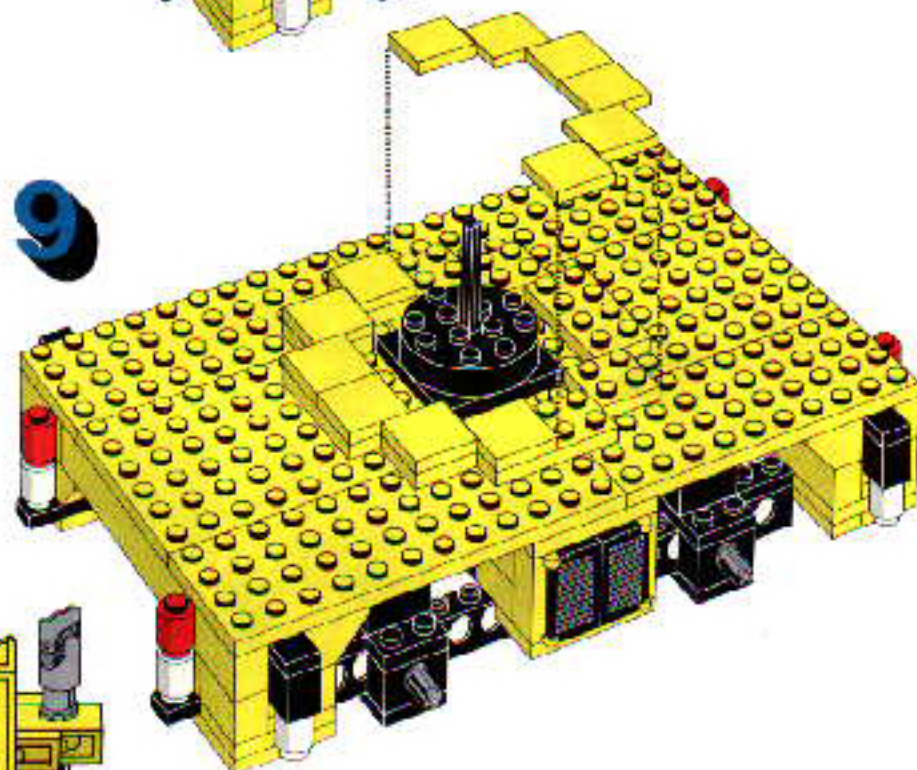
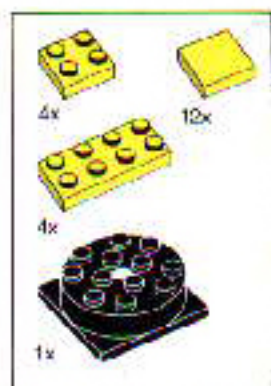
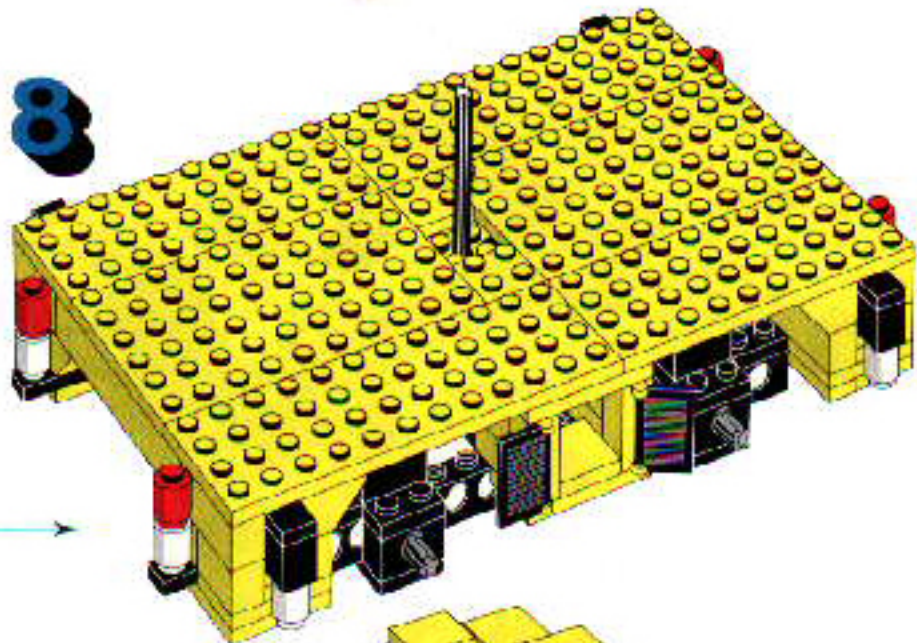
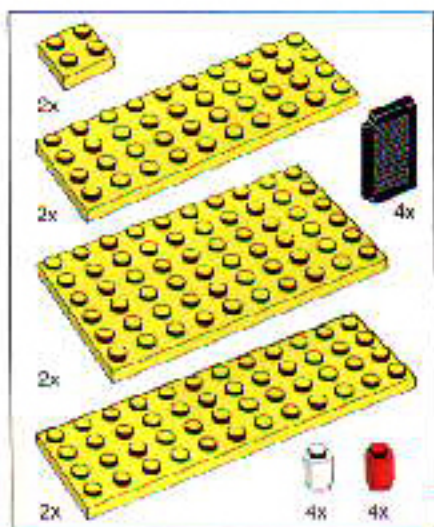

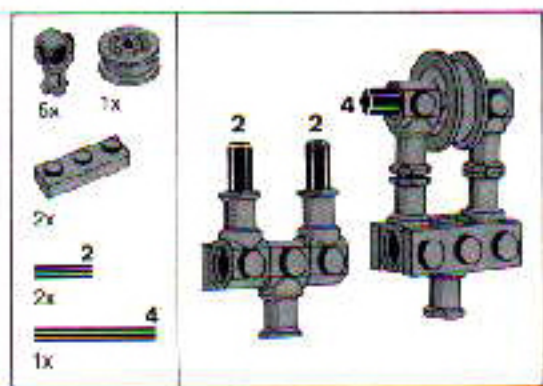

10

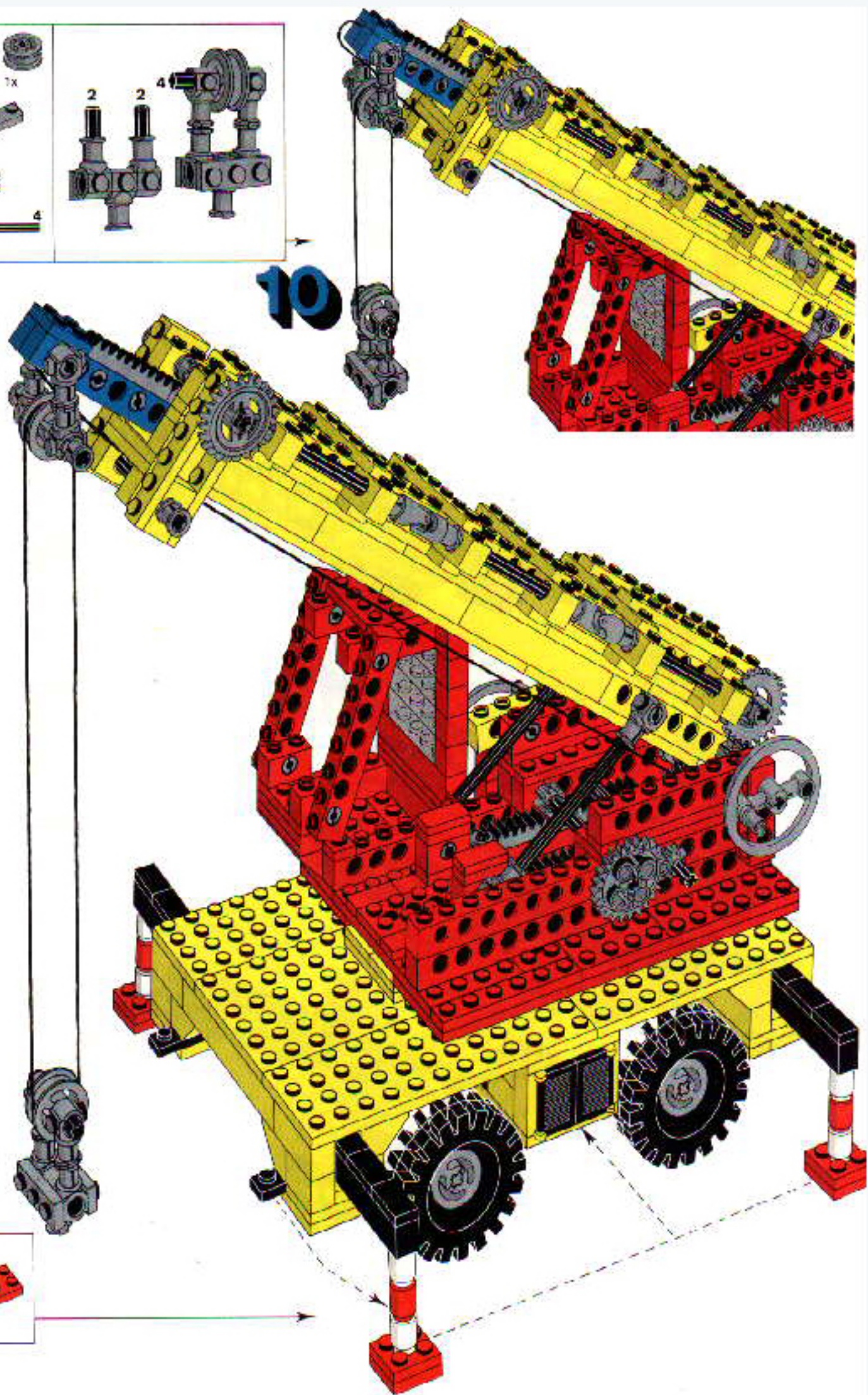

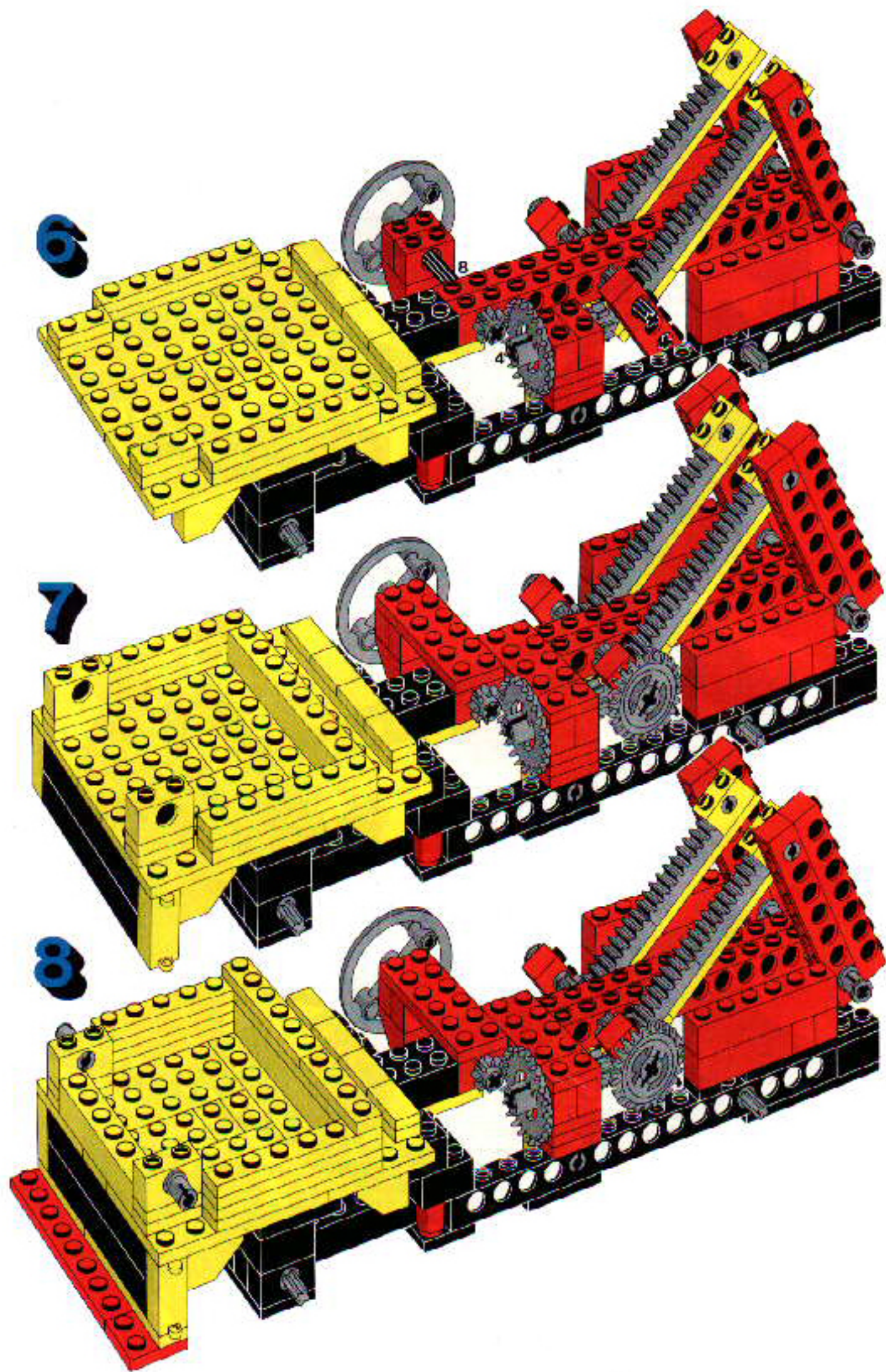

9

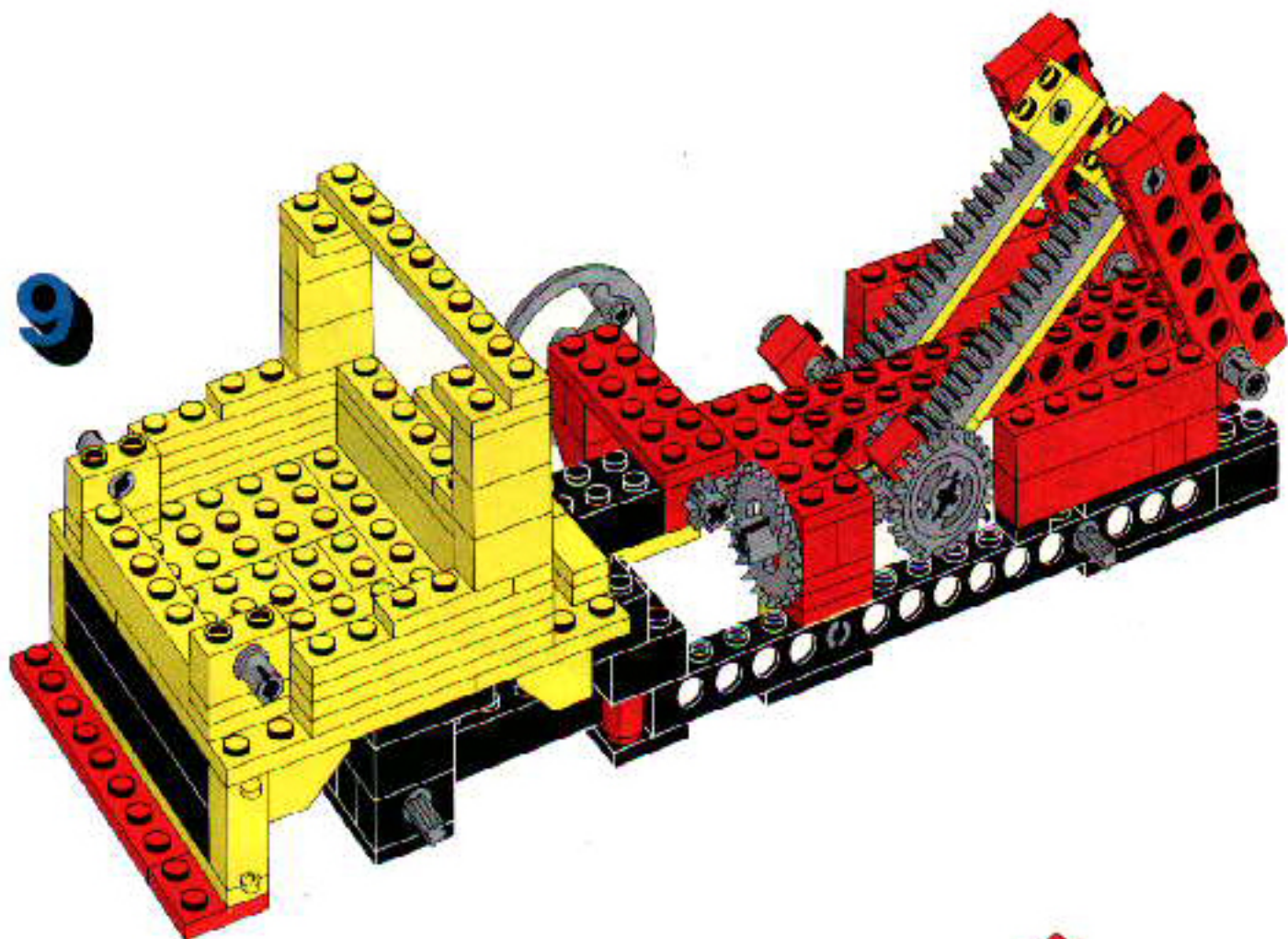

10

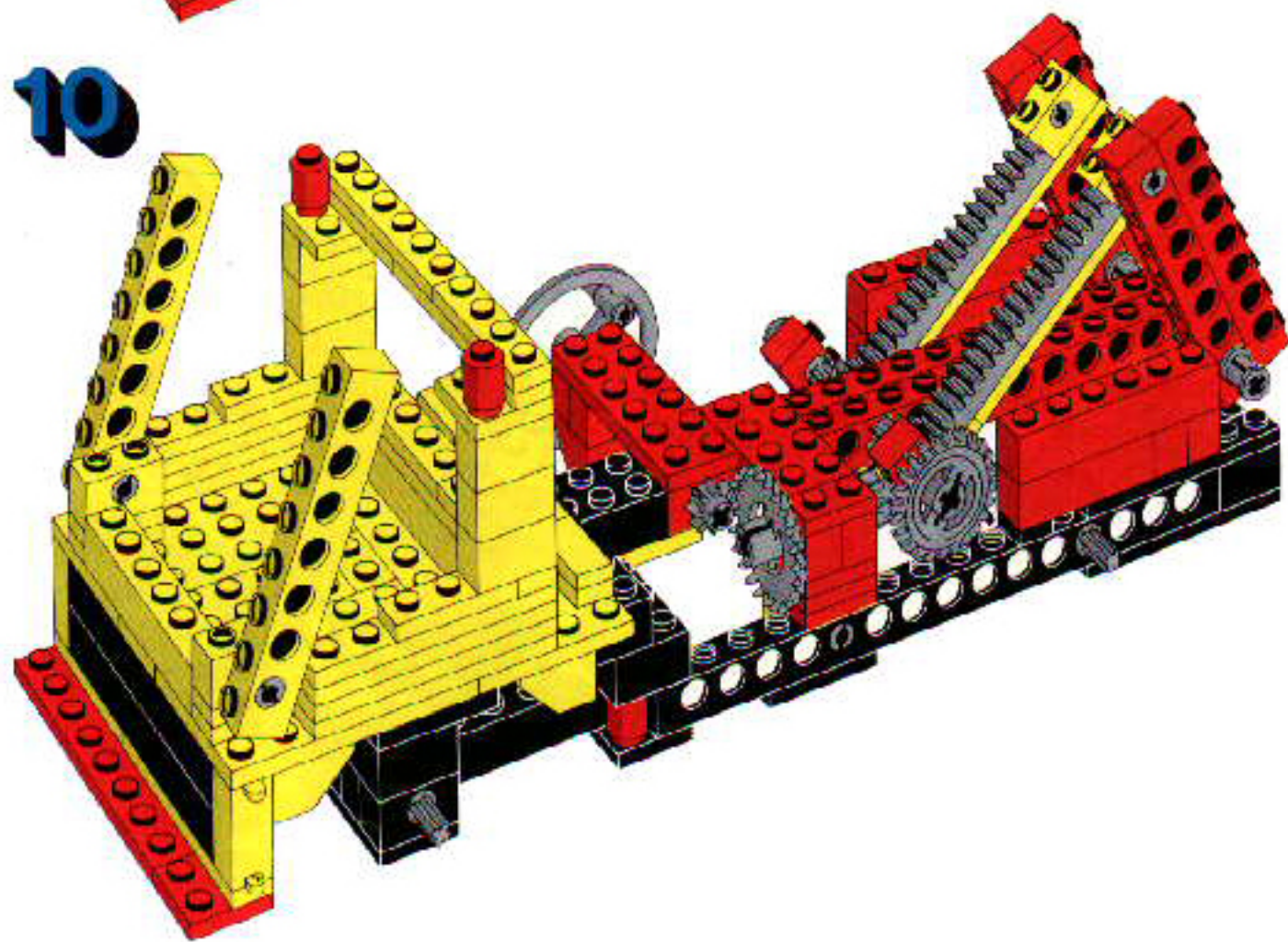

11

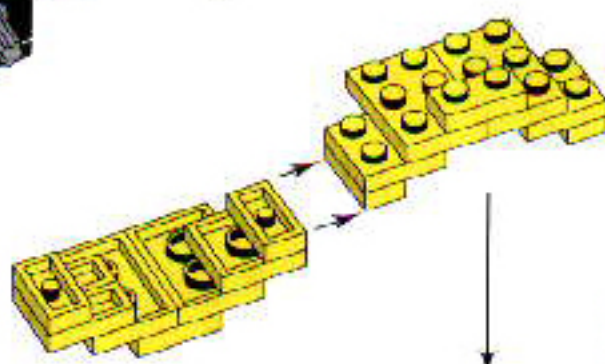
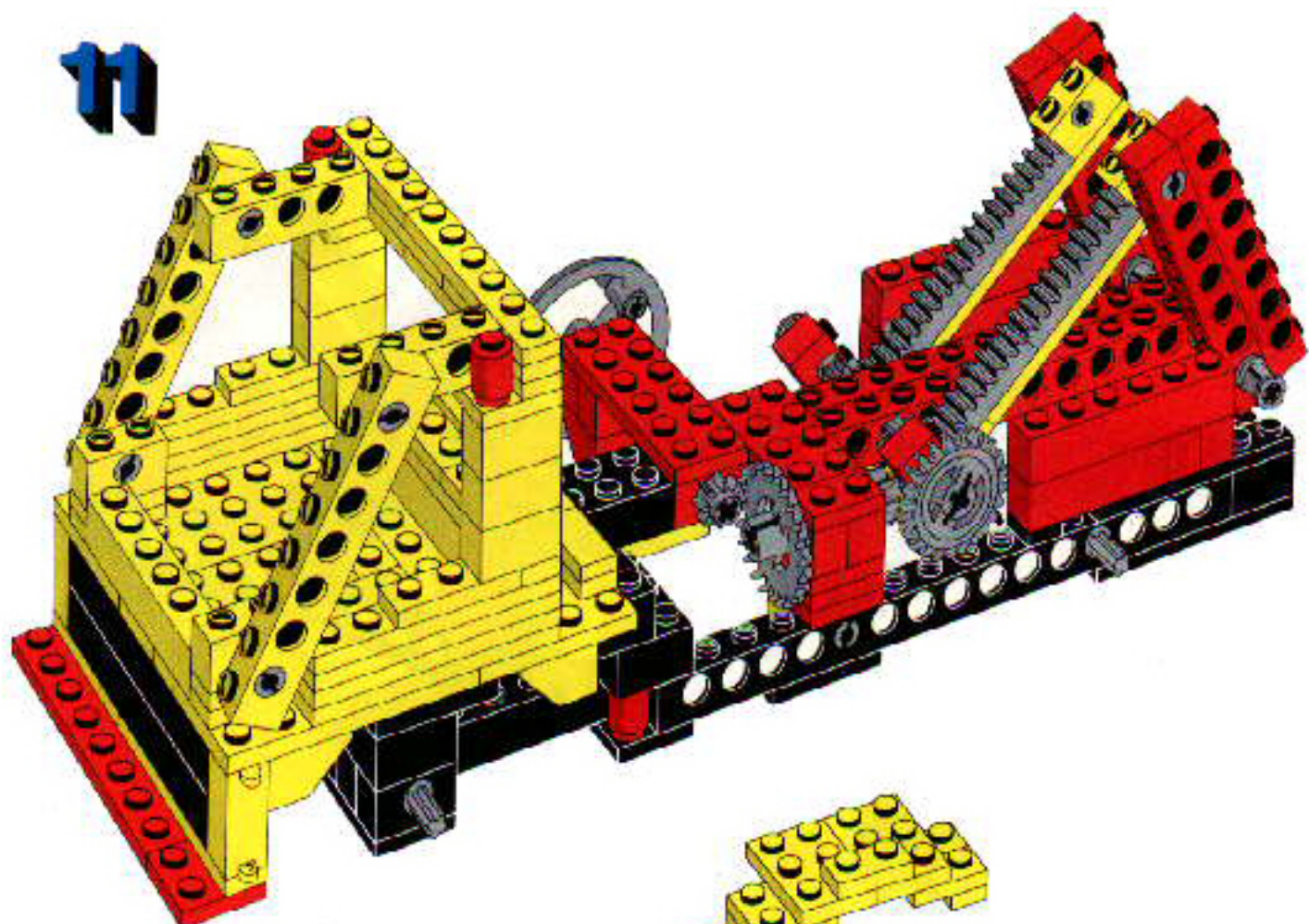

12

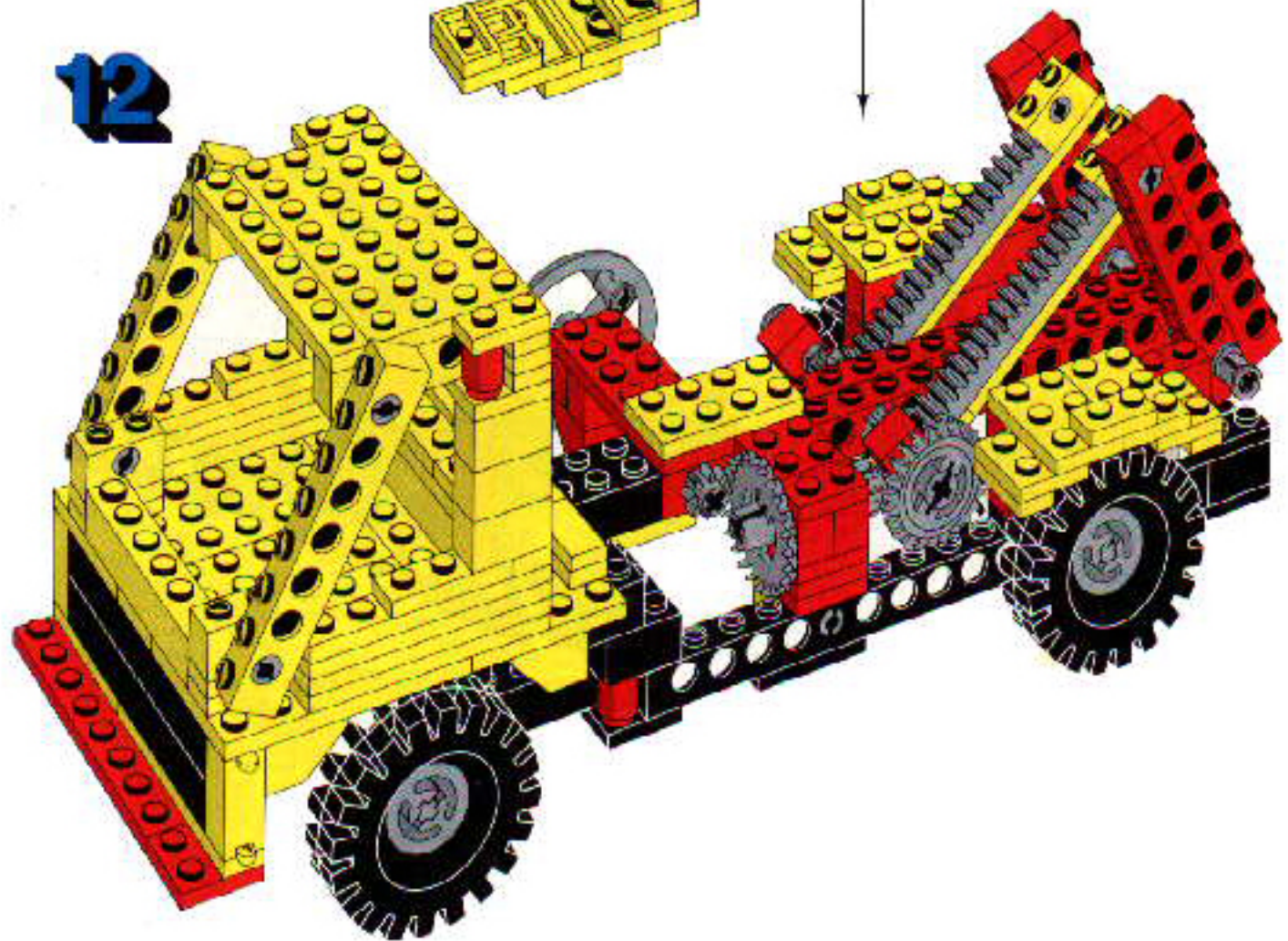

13

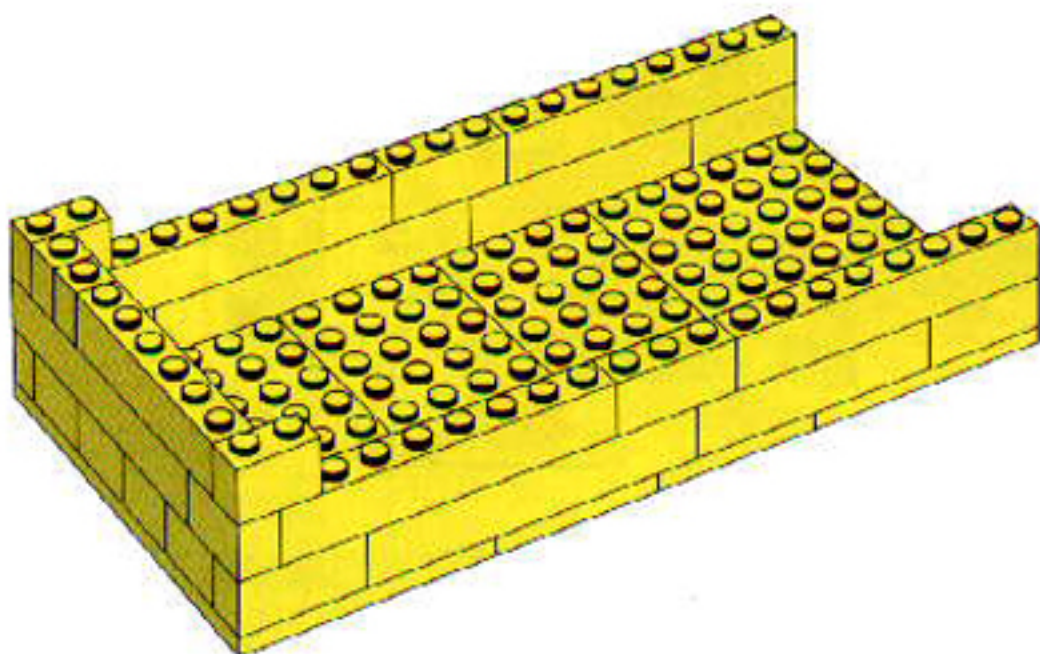

14

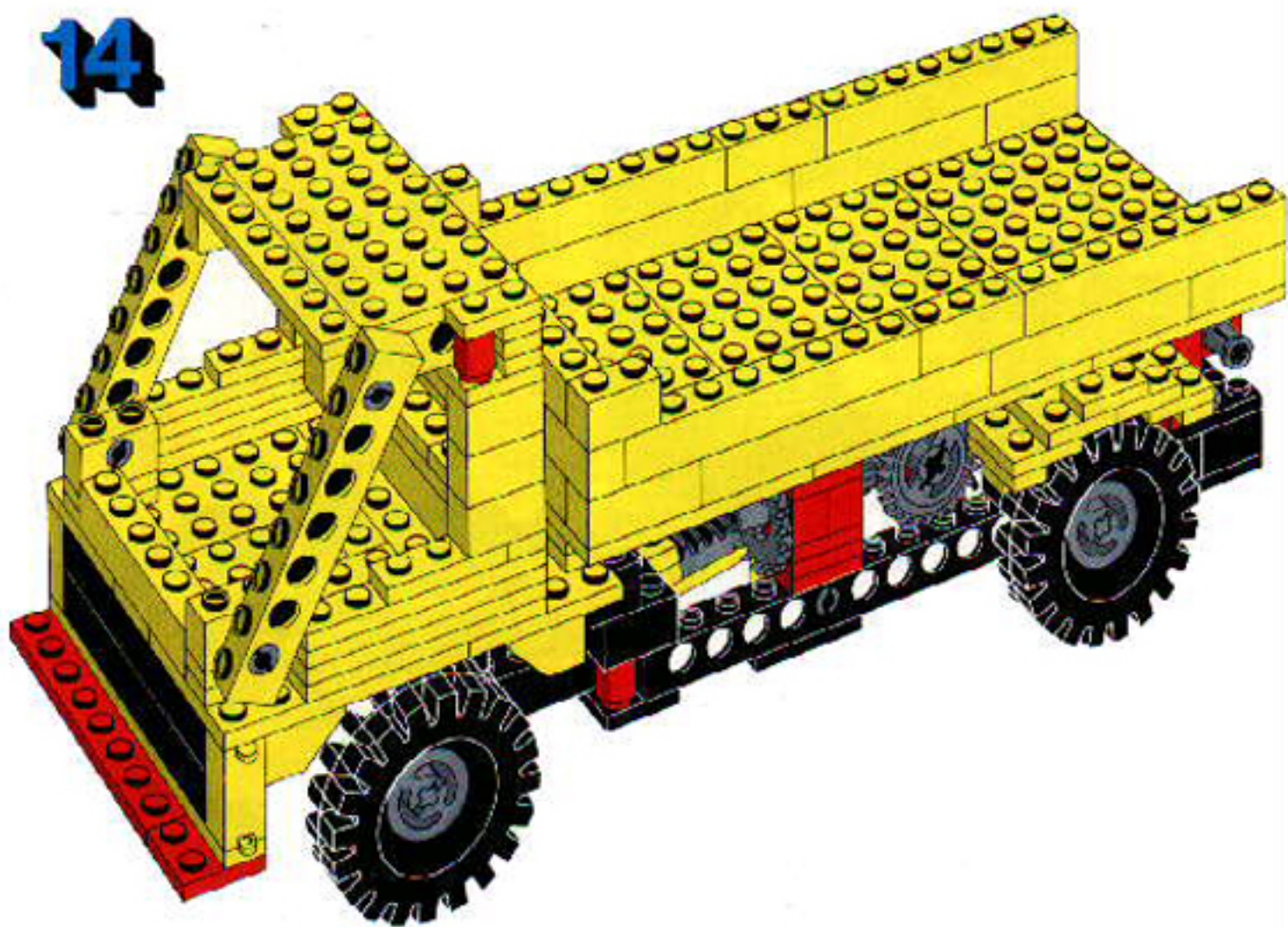

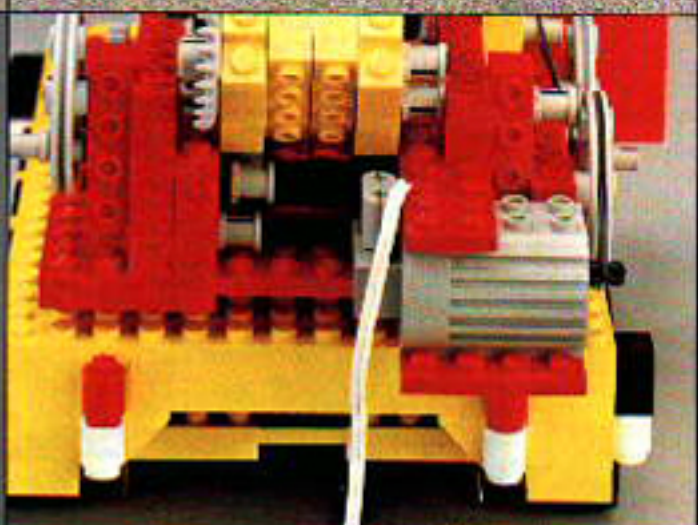
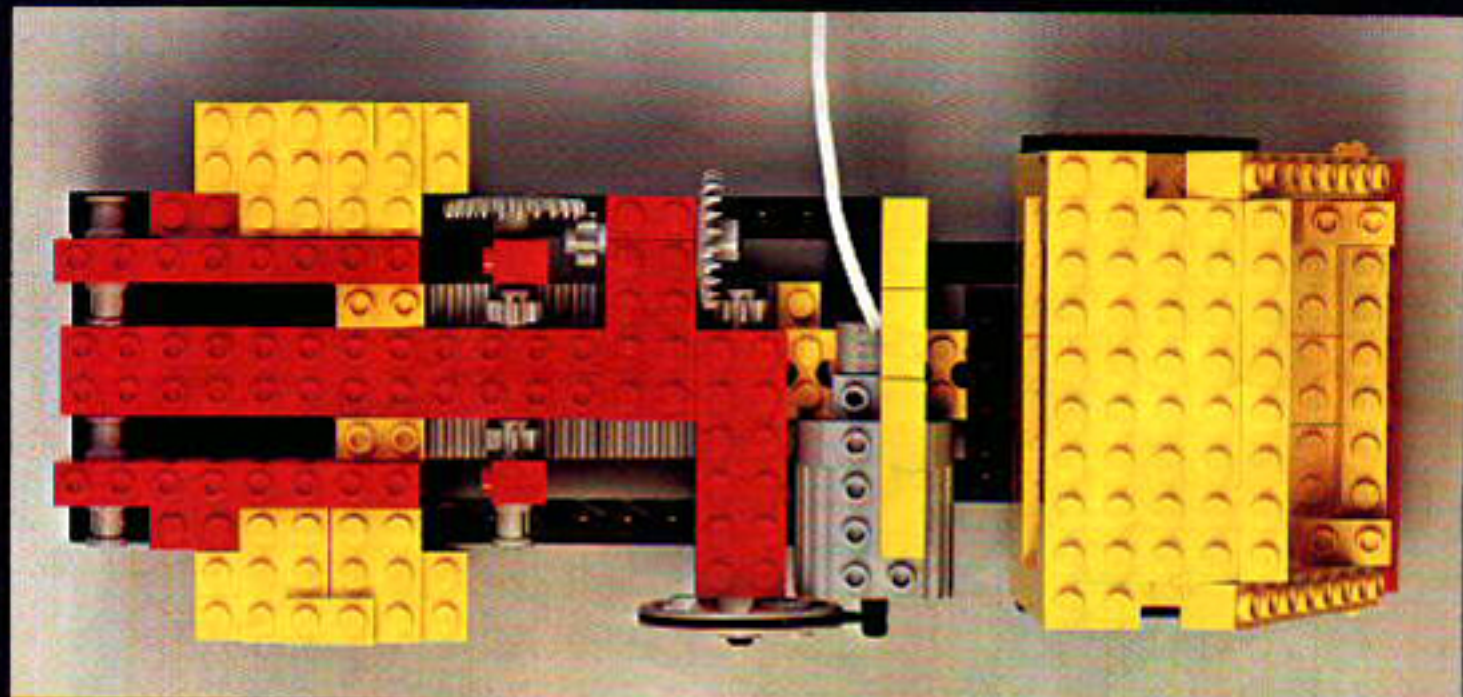

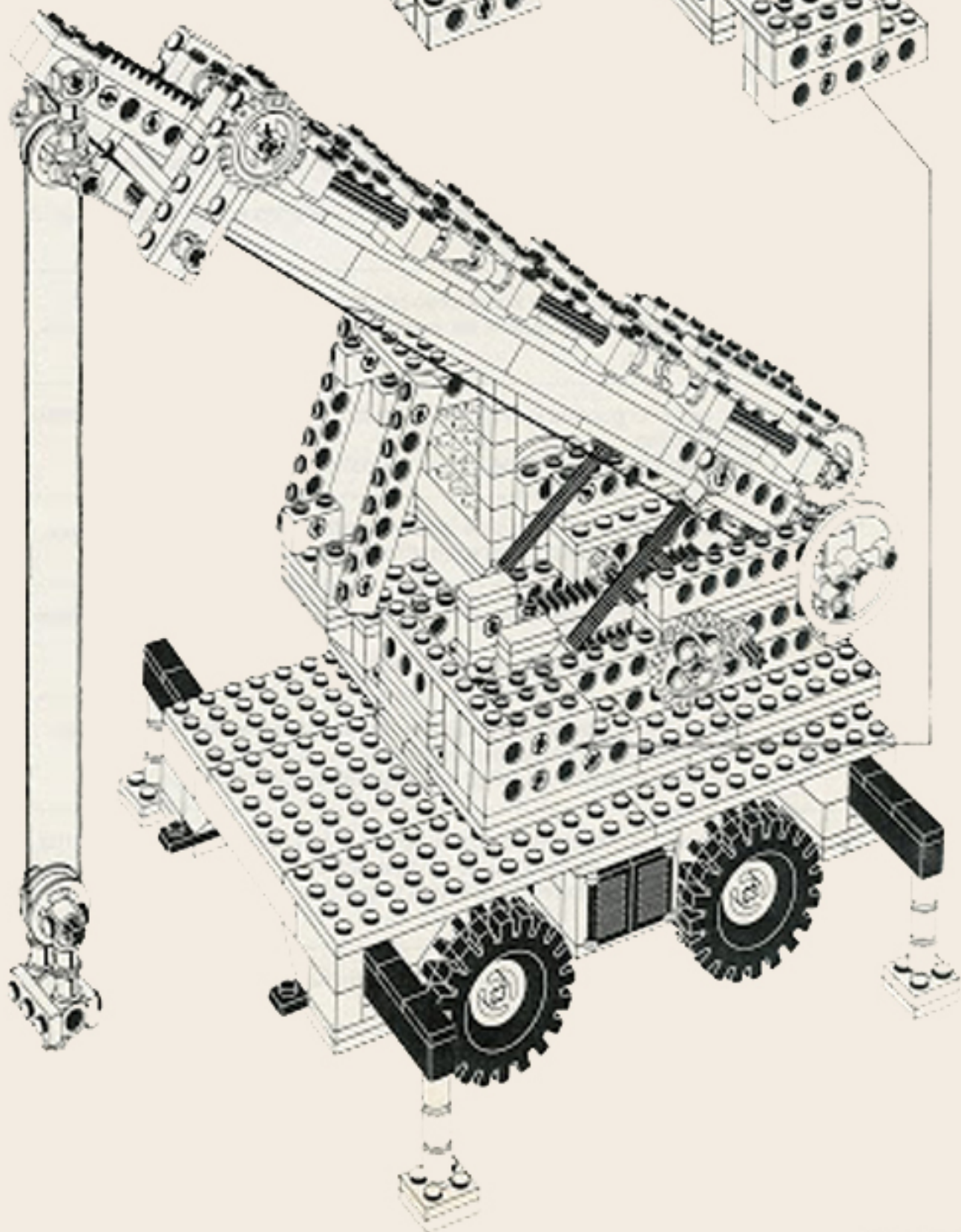
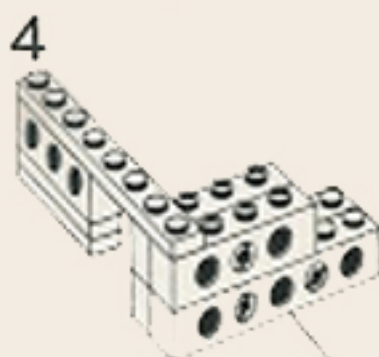
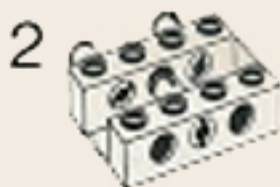
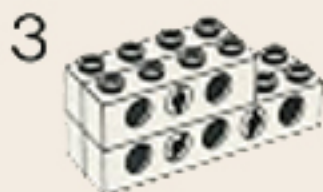
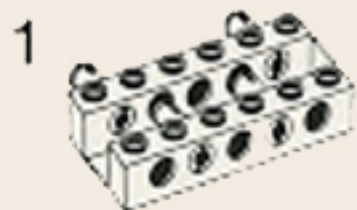
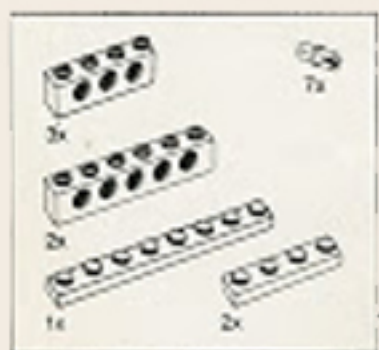

855/955

- DK** Ved hård belastning af kranarmen kan det være en fordel at forstærke konstruktionen.
På omstående side er vist et eksempel på, hvorledes en sådan forstærkning kan foretages.
-
- N** Ved sterk belastning av kranarmen kan det være en fordel å forsterke konstruksjonen.
Et eksempel er vist på den andre siden hvorledes en slik forsterkning kan gjøres.
-
- S** Vid hård belastning av kranarmen bør man förstärka konstruktionen.
På omstående sida visar vi ett exempel på hur man kan förstärka kranarmen.
-
- SF** Jos nasturin puomia kuormitetaan kovasti, voi rakenteen vahvistaminen olla tarpeen.
Kääntöpuolella näytämme, miten vahvistaminen voidaan suorittaa.
-
- UK/USA** When the boom of the crane is fully extended or used for lifting heavy loads you can give it extra strength as shown overleaf.
-
- F** Si la grue doit déplacer de grosses charges, il est préférable de consolider le fourche.
Au dos, on l'explique comment le faire.
-
- D** Soll der hereausgefahrene Ausleger besonders schwere Lasten heben, ist es ratsam, die «Ausleger-Konstruktion» zu verstärken.
Wie das gemacht wird, zeigt das Beispiel auf der nächsten Seite.
-
- NL** Wanneer de uitgeschoven mast van de kraan overbelast wordt kan het verstandig zijn de constructie te verzwaren.
De afbeelding aan omtszijde laat je zien hoe je zo'n versterking kunt maken.
-
- I** Quando il braccio della gru raggiunge la massima estensione sarà opportuno rinforzare la costruzione.
Sul retro è raffigurato un esempio di come eseguire l'operazione.

LEGO Mobile Crane 955





This model isn't just fun to build – it's a thrill to operate! It gives you an extending boom with adjustable angle. A fully rotating operating base. A lifting pod you can lower and raise by simply turning a ratchet handle. There are heavy-duty tires for rolling; adjustable stabilizers to keep it still.

The same pieces may be used to build other models too, including a dump truck, container hoist, a shipyard crane and more.



NEW

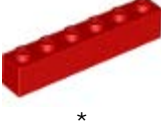

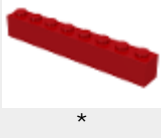
Image	Qty	Item No	Description	MID
Regular Items:				
Parts:				
+  *	8	3005	Red Brick 1 x 1 Catalog: Parts: Brick	PG
+  *	6	3005	Yellow Brick 1 x 1 Catalog: Parts: Brick	PG
+  *	14	3004	Yellow Brick 1 x 2 Catalog: Parts: Brick	PG
+  *	8	3622	Yellow Brick 1 x 3 Catalog: Parts: Brick	PG
+  *	1	3010	Red Brick 1 x 4 Catalog: Parts: Brick	PG
+  *	4	3010	Trans-Clear Brick 1 x 4 Catalog: Parts: Brick	PG
+  *	3	3009	Red Brick 1 x 6 Catalog: Parts: Brick	PG
+  *	4	3009	Yellow Brick 1 x 6 Catalog: Parts: Brick	PG
+  *	4	3008	Black Brick 1 x 8 Catalog: Parts: Brick	PG
+  *	1	3008	Red Brick 1 x 8 Catalog: Parts: Brick	PG
+  *	8	3008	Yellow Brick 1 x 8 Catalog: Parts: Brick	PG

+  4 [3003old](#) **Black Brick 2 x 2 without Inside Supports** [Catalog](#): [Parts](#): [Brick](#) [PG](#)

*

+  4 [3002old](#) **Black Brick 2 x 3 without Cross Supports** [Catalog](#): [Parts](#): [Brick](#) [PG](#)

*

+  4 [3001old](#) **Black Brick 2 x 4 without Cross Supports** [Catalog](#): [Parts](#): [Brick](#) [PG](#)

*

+  2 [3007](#) **Black Brick 2 x 8** [Catalog](#): [Parts](#): [Brick](#) [PG](#)

*

+  4 [3581](#) **Yellow Brick, Modified 1 x 1 x 2 with Shutter Holder** [Catalog](#): [Parts](#): [Brick](#), [Modified](#) [PG](#)

*

+  4 [3062b](#) **Red Brick, Round 1 x 1 Open Stud** [Catalog](#): [Parts](#): [Brick](#), [Round](#) [PG](#)

*

+  8 [3062b](#) **White Brick, Round 1 x 1 Open Stud** [Catalog](#): [Parts](#): [Brick](#), [Round](#) [PG](#)

*

+  4 [3024](#) **Black Plate 1 x 1** [Catalog](#): [Parts](#): [Plate](#) [PG](#)

*

+  2 [3023](#) **Red Plate 1 x 2** [Catalog](#): [Parts](#): [Plate](#) [PG](#)

*

+  19 [3023](#) **Yellow Plate 1 x 2** [Catalog](#): [Parts](#): [Plate](#) [PG](#)

*

+  2 [3623](#) **Light Gray Plate 1 x 3** [Catalog](#): [Parts](#): [Plate](#) [PG](#)

*

+  6 [3623](#) **Yellow Plate 1 x 3** [Catalog](#): [Parts](#): [Plate](#) [PG](#)

*

+



*

1

[3710](#)

Red Plate 1 x 4

[Catalog:](#) [Parts:](#) [Plate](#)

[PG](#)

1



+



*

12

[3710](#)

Yellow Plate 1 x 4

[Catalog:](#) [Parts:](#) [Plate](#)

[PG](#)

+



*

4

[3666](#)

Black Plate 1 x 6

[Catalog:](#) [Parts:](#) [Plate](#)

[PG](#)

+



*

4

[3666](#)

Red Plate 1 x 6

[Catalog:](#) [Parts:](#) [Plate](#)

[PG](#)

+



*

22

[3666](#)

Yellow Plate 1 x 6

[Catalog:](#) [Parts:](#) [Plate](#)

[PG](#)

+



*

4

[3460](#)

Red Plate 1 x 8

[Catalog:](#) [Parts:](#) [Plate](#)

[PG](#)

1



+



*

6

[3460](#)

Yellow Plate 1 x 8

[Catalog:](#) [Parts:](#) [Plate](#)

[PG](#)

+

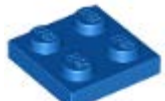

*

3

[3022](#)

Blue Plate 2 x 2

[Catalog:](#) [Parts:](#) [Plate](#)

[PG](#)

+



*

8

[3022](#)

Red Plate 2 x 2

[Catalog:](#) [Parts:](#) [Plate](#)

[PG](#)

+



*

6

[3022](#)

Yellow Plate 2 x 2

[Catalog:](#) [Parts:](#) [Plate](#)

[PG](#)

+



*

8

[3021](#)

Black Plate 2 x 3

[Catalog:](#) [Parts:](#) [Plate](#)

[PG](#)

+



*

8

[3021](#)

Yellow Plate 2 x 3

[Catalog:](#) [Parts:](#) [Plate](#)

[PG](#)

+



*

3

[3020](#)

Red Plate 2 x 4

[Catalog:](#) [Parts:](#) [Plate](#)

[PG](#)

+



*

7

[3020](#)

Yellow Plate 2 x 4

[Catalog:](#) [Parts:](#) [Plate](#)

[PG](#)

+



*

3

[3795](#)

Red Plate 2 x 6

[Catalog:](#) [Parts:](#) [Plate](#)

[PG](#)

+



*

2

[3034](#)

Red Plate 2 x 8

[Catalog:](#) [Parts:](#) [Plate](#)

[PG](#)

+

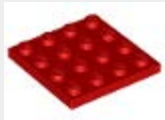

*

1

[3031](#)

Red Plate 4 x 4

[Catalog:](#) [Parts:](#) [Plate](#)

[PG](#)

+



*

2

[3032](#)

Yellow Plate 4 x 6

[Catalog:](#) [Parts:](#) [Plate](#)

[PG](#)

+



*

5

[3035](#)

Red Plate 4 x 8

[Catalog:](#) [Parts:](#) [Plate](#)

[PG](#)

+



*

1

[3035](#)

Yellow Plate 4 x 8

[Catalog:](#) [Parts:](#) [Plate](#)

[PG](#)

+



*

3

[3030](#)

Yellow Plate 4 x 10

[Catalog:](#) [Parts:](#) [Plate](#)

[PG](#)

+



*

1

[3029](#)

Red Plate 4 x 12

[Catalog:](#) [Parts:](#) [Plate](#)

[PG](#)

+



*

3

[3029](#)

Yellow Plate 4 x 12

[Catalog:](#) [Parts:](#) [Plate](#)

[PG](#)

+



*













2













[3033](#)

Yellow Plate 6 x 10

[Catalog:](#) [Parts:](#) [Plate](#)

[PG](#)

+	 *	1	3028	Red Plate 6 x 12 Catalog: Parts: Plate	PG
+	 *	1	x88	Black Rubber Band Small (Square Cross Section) Catalog: Parts: Rubber Band & Belt	PG
+	 *	8	3665	Yellow Slope, Inverted 45 2 x 1 Catalog: Parts: Slope, Inverted	PG
+	 *	2	3660	Red Slope, Inverted 45 2 x 2 Catalog: Parts: Slope, Inverted	PG
+	 *	1	x77a	Black String, Cord Thin (Undetermined Length) Catalog: Parts: String	PG
+	 *	17	3713	Light Gray Technic Bush Catalog: Parts: Technic	PG
+	 *	4	3704	Black Technic, Axle 2 Catalog: Parts: Technic, Axle	PG
+	 *	2	3705	Black Technic, Axle 4 Catalog: Parts: Technic, Axle	PG
+	 *	2	3706	Black Technic, Axle 6 Catalog: Parts: Technic, Axle	PG
+	 *	10	3707	Black Technic, Axle 8 Catalog: Parts: Technic, Axle	PG
+	 *	3	3708	Black Technic, Axle 12 Catalog: Parts: Technic, Axle	PG
+	 *	13	3651	Light Gray Technic, Axle and Pin Connector Catalog: Parts: Technic, Connector	PG

+	 *	5	3749	Light Gray Technic, Axle Pin without Friction Ridges Lengthwise	PG
				Catalog: Parts: Technic: Axle	
+	 *	4	3700	Black Technic, Brick 1 x 2 with Hole	PG
				Catalog: Parts: Technic: Brick	
+	 *	4	3700	Red Technic, Brick 1 x 2 with Hole	PG
				Catalog: Parts: Technic: Brick	
+	 *	12	3700	Yellow Technic, Brick 1 x 2 with Hole	PG
				Catalog: Parts: Technic: Brick	
+	 *	2	3701	Blue Technic, Brick 1 x 4 with Holes	PG
				Catalog: Parts: Technic: Brick	
+	 *	4	3701	Red Technic, Brick 1 x 4 with Holes	PG
				Catalog: Parts: Technic: Brick	1
+	 *	3	3701	Yellow Technic, Brick 1 x 4 with Holes	PG
				Catalog: Parts: Technic: Brick	
+	 *	10	3702	Red Technic, Brick 1 x 8 with Holes	PG
				Catalog: Parts: Technic: Brick	
+	 *	2	3702	Yellow Technic, Brick 1 x 8 with Holes	PG
				Catalog: Parts: Technic: Brick	
+	 *	2	3703	Black Technic, Brick 1 x 16 with Holes	PG
				Catalog: Parts: Technic: Brick	
+	 *	4	3703	Blue Technic, Brick 1 x 16 with Holes	PG
				Catalog: Parts: Technic: Brick	
+	 *	3	3703	Red Technic, Brick 1 x 16 with Holes	PG
				Catalog: Parts: Technic: Brick	

+		4	3703	Yellow Technic, Brick 1 x 16 with Holes Catalog: Parts: Technic, Brick	PG
---	--	---	----------------------	--	--------------------

*

+		9	3647	Light Gray Technic, Gear 8 Tooth Type 1 Catalog: Parts: Technic, Gear	PG
---	---	---	----------------------	---	--------------------

*

+		2	x187	Light Gray Technic, Gear 24 Tooth (1st Version - 3 Axle Holes) Catalog: Parts: Technic, Gear	PG
---	---	---	----------------------	--	--------------------

*

+		2	3650a	Light Gray Technic, Gear 24 Tooth Crown (1st Version - Not Reinforced) Catalog: Parts: Technic, Gear	PG
---	---	---	-----------------------	--	--------------------

*

+		12	3743	Light Gray Technic, Gear Rack 1 x 4 Catalog: Parts: Technic, Gear	PG
---	---	----	----------------------	---	--------------------

*

+		28	3673	Light Gray Technic, Pin without Friction Ridges Lengthwise Catalog: Parts: Technic, Pin	PG	1	■
---	--	----	----------------------	---	--------------------	---	---

*

+		2	3738	Red Technic, Plate 2 x 8 with 7 Holes Catalog: Parts: Technic, Plate	PG
---	---	---	----------------------	--	--------------------

*

+		2	3738	Yellow Technic, Plate 2 x 8 with 7 Holes Catalog: Parts: Technic, Plate	PG
---	---	---	----------------------	---	--------------------

*

+		3	3736	Light Gray Technic, Steering Pulley Large Catalog: Parts: Technic, Steering	PG
---	---	---	----------------------	---	--------------------

*

+		2	9244c01 (inv)	Light Gray Technic, Universal Joint 4L Catalog: Parts: Technic, Connector	PG
---	---	---	-------------------------------	---	--------------------

*

+		4	3070b	Black Tile 1 x 1 with Groove (3070) Catalog: Parts: Tile	PG
---	---	---	-----------------------	--	--------------------

*

+		16	3069b	Black Tile 1 x 2 with Groove Catalog: Parts: Tile	PG
---	---	----	-----------------------	---	--------------------

*

+		16	3069b	Red Tile 1 x 2 with Groove Catalog: Parts: Tile	PG
	*				

+		4	3069b	Yellow Tile 1 x 2 with Groove Catalog: Parts: Tile	PG
	*				

+		29	3068b	Yellow Tile 2 x 2 with Groove Catalog: Parts: Tile	PG
	*				

+		4	3634	Black Tire 17 x 43 Catalog: Parts: Tire & Tread	PG
	*				

+		1	3403c01 (inv)	Black Turntable 4 x 4 Square Base with Same Color Turntable 4 x 4 Top (3403 / 3404) Catalog: Parts: Turntable	PG
	*				

+		6	3482	Light Gray Wheel with Split Axle Hole Catalog: Parts: Wheel	PG
	*				

+		4	3582	Black Window 1 x 2 x 2 Shutter Catalog: Parts: Window	PG
	*				

Extra Items:

+		1	3062b	White Brick, Round 1 x 1 Open Stud Catalog: Parts: Brick, Round	PG
	*				

+		1	3024	Black Plate 1 x 1 Catalog: Parts: Plate	PG
	*				

+		1	3070b	Black Tile 1 x 1 with Groove (3070) Catalog: Parts: Tile	PG
	*				

+		1	3069b	Black Tile 1 x 2 with Groove Catalog: Parts: Tile	PG
	*				

+		1	3069b	Red Tile 1 x 2 with Groove Catalog: Parts: Tile	PG
---	--	---	-----------------------	---	--------------------



*

+		1	3069b	Yellow Tile 1 x 2 with Groove Catalog: Parts: Tile	PG
---	--	---	-----------------------	--	--------------------

*

+		1	3068b	Yellow Tile 2 x 2 with Groove Catalog: Parts: Tile	PG
---	--	---	-----------------------	--	--------------------

*

+		1	3582	Black Window 1 x 2 x 2 Shutter Catalog: Parts: Window	PG
---	--	---	----------------------	---	--------------------

*

Counterparts:

+		4	3482c03(inv)	Light Gray Wheel with Split Axle Hole with Black Tire 17 x 43 (3482 / 3634) Catalog: Parts: Wheel & Tire Assembly	PG
---	--	---	------------------------------	---	--------------------

*

Alternate Items:

+		3	3710	Red Plate 1 x 4 Catalog: Parts: Plate	PG	1	
---	--	---	----------------------	---	--------------------	---	--

*

+		5	3460	Red Plate 1 x 8 Catalog: Parts: Plate	PG	1	
---	--	---	----------------------	---	--------------------	---	--

*

+		7	3701	Red Technic, Brick 1 x 4 with Holes Catalog: Parts: Technic, Brick	PG	1	
---	--	---	----------------------	--	--------------------	---	--

*

+		2	3894	Red Technic, Brick 1 x 6 with Holes Catalog: Parts: Technic, Brick	PG	1	
---	--	---	----------------------	--	--------------------	---	--

*

+		35	3673	Light Gray Technic, Pin without Friction Ridges Lengthwise Catalog: Parts: Technic, Pin	PG	1	
---	--	----	----------------------	---	--------------------	---	--

*

Note:**Redesigned during production.**

There are at least 2 different versions of instructions for this set. The differences for the second version are indicated in this inventory in the Alternate Items section with Match ID 99.

Quick overview of redesign: Several parts, including a pair of 1 x 6 technic bricks that were newly released in 1979, are added to strengthen the crane boom.

Summary:

Type	Unique Lots	Total Qty
Regular Items:		
Parts	90	512
Extra Items:		
Parts	8	8
Counterparts:		
Parts	1	4
Alternative Items:		
Parts	5	52

[ctw_3 \(204\)](#)  inventoried this Set on Dec 1, 2003, inventory last updated on Apr 27, 2018.