

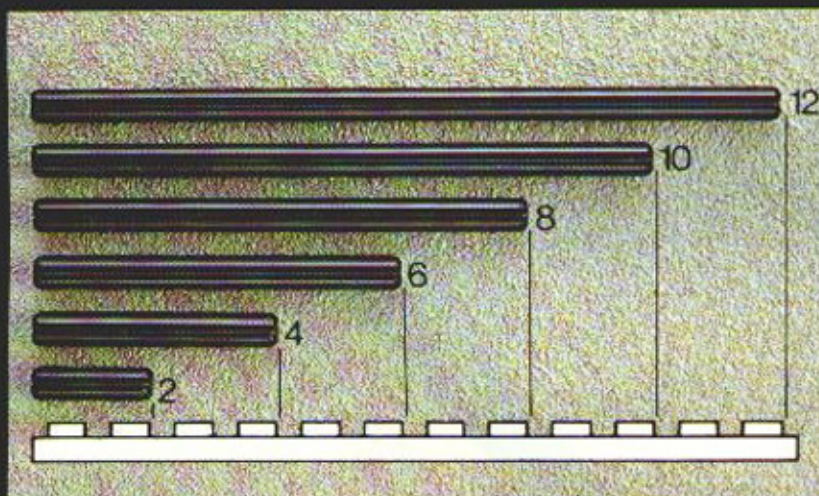

120058



In der Bauanleitung steht vor den Achsen eine Zahl, die die benötigte Länge der Achsen anzeigt.

Numbers in the building instructions near axles show the length of axle to be used.

Dans les conseils de construction, il y a un chiffre à côté de chaque axe. Ce chiffre indique la longueur des axes à utiliser.

Ut for akslerne i byggeanvisningen er anført et tal som viser hvilken aksellengde som skal brukes.

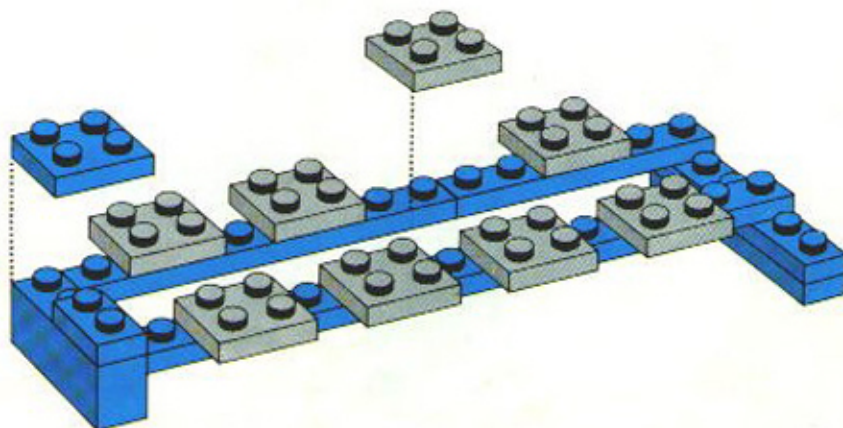
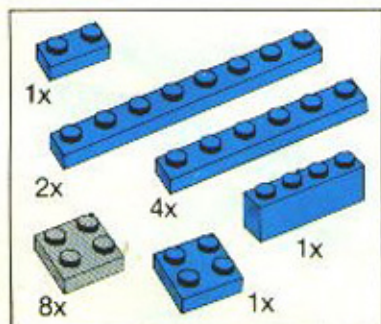

2

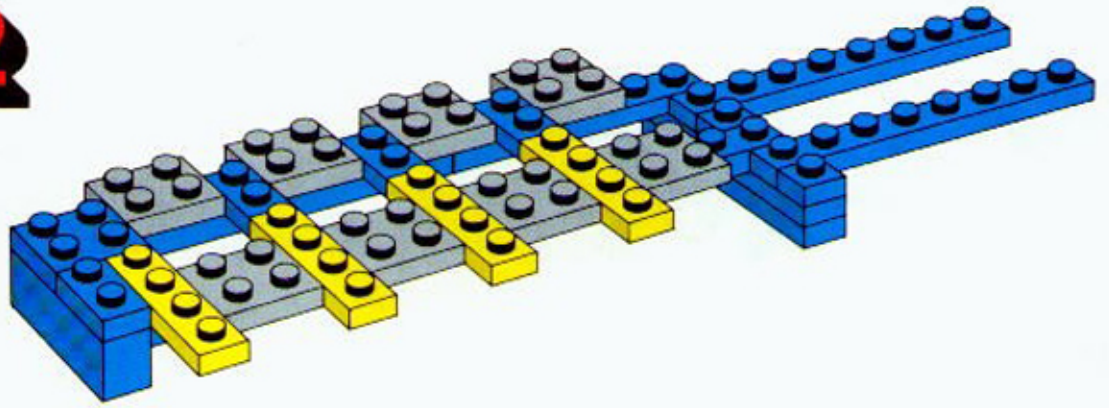
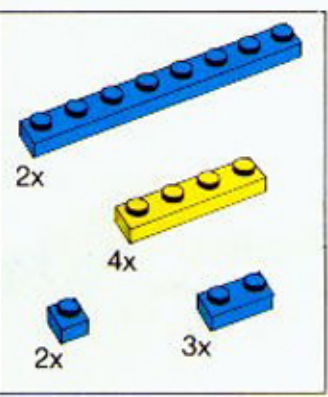

3

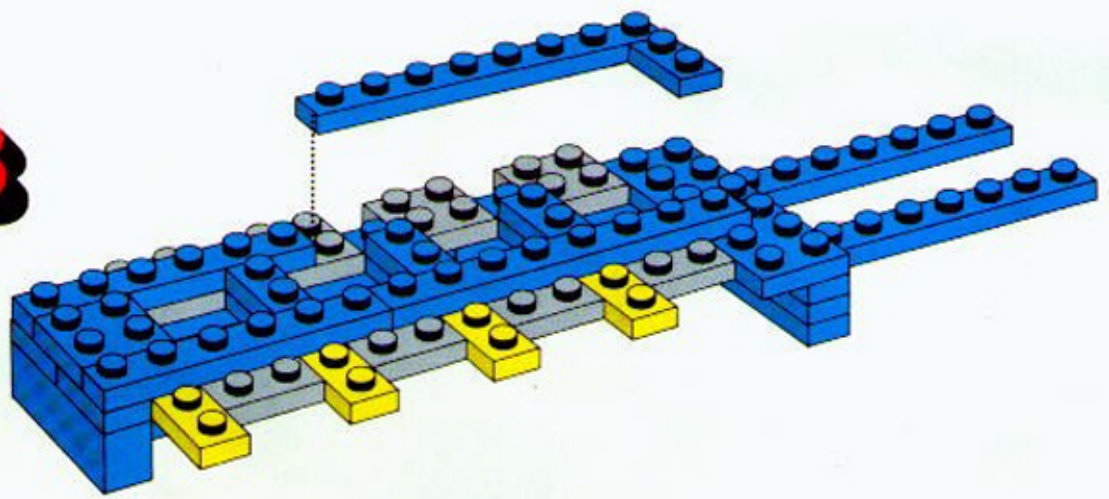
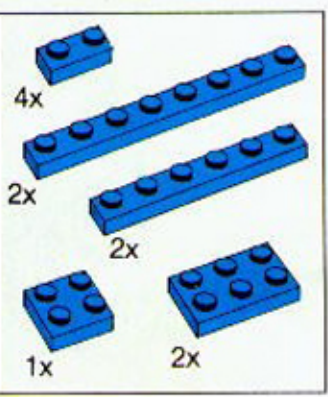

4

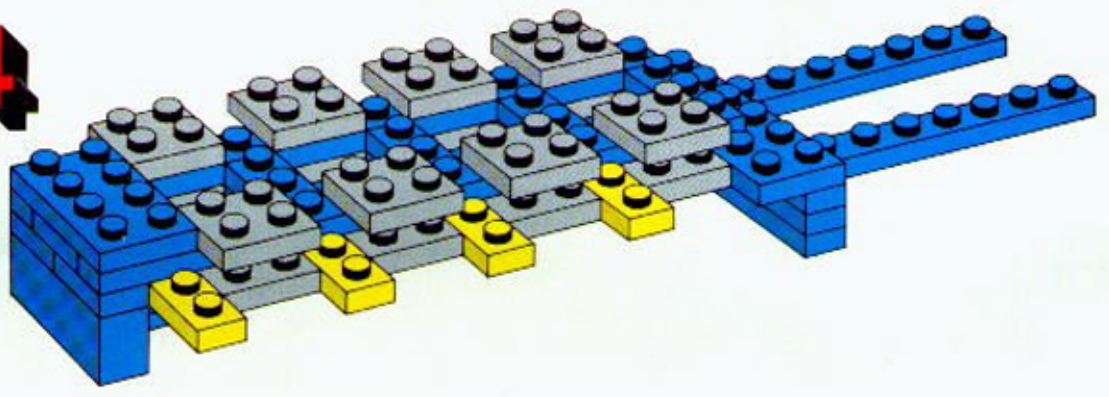
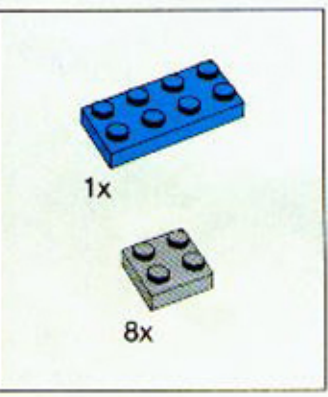

5

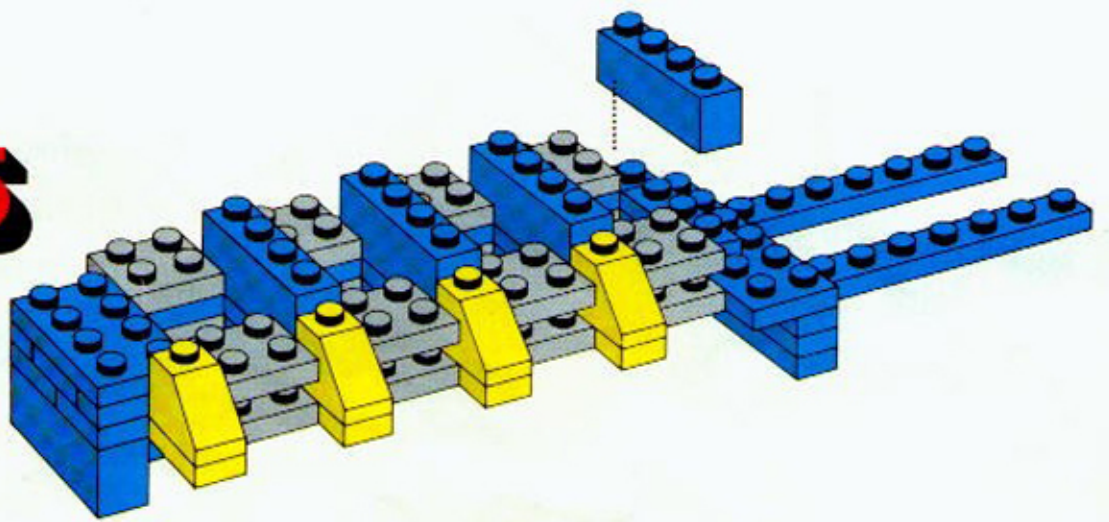
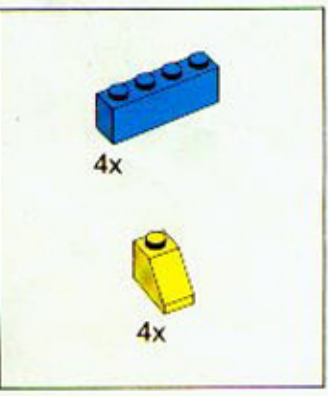

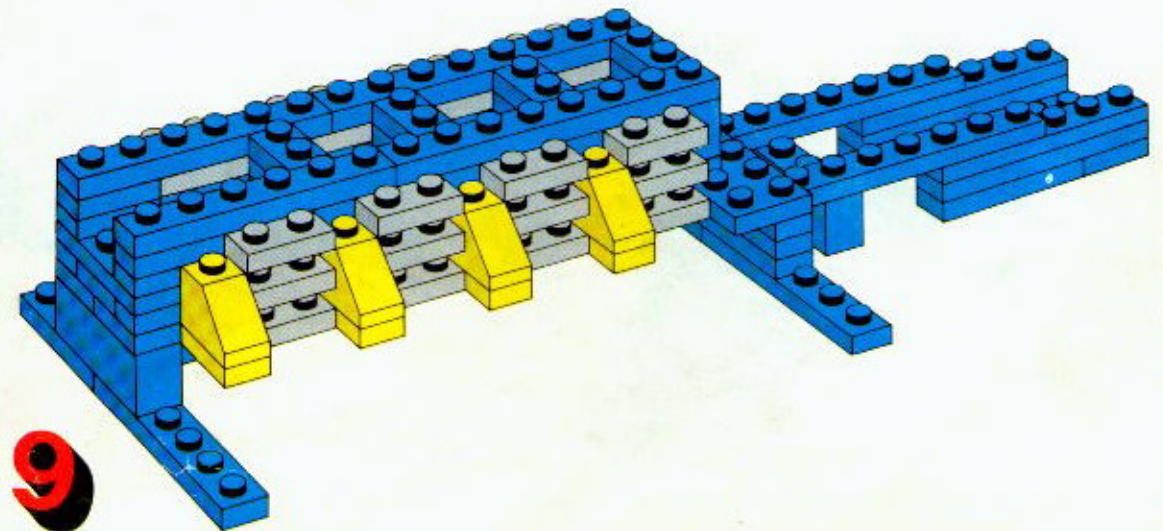
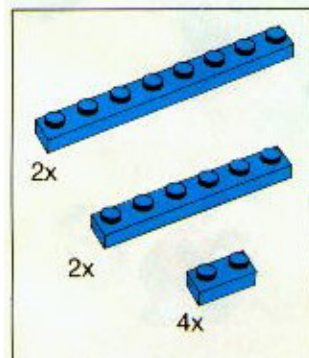
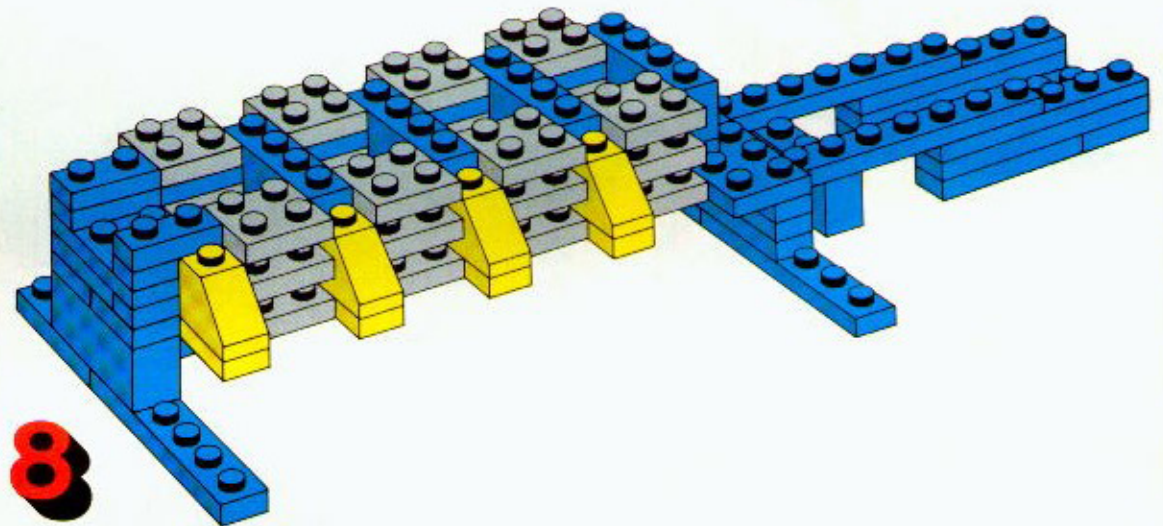
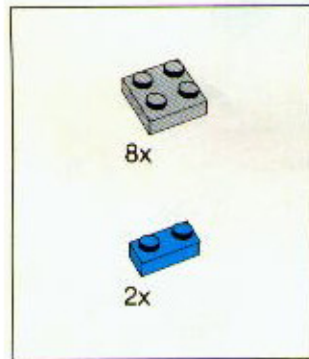
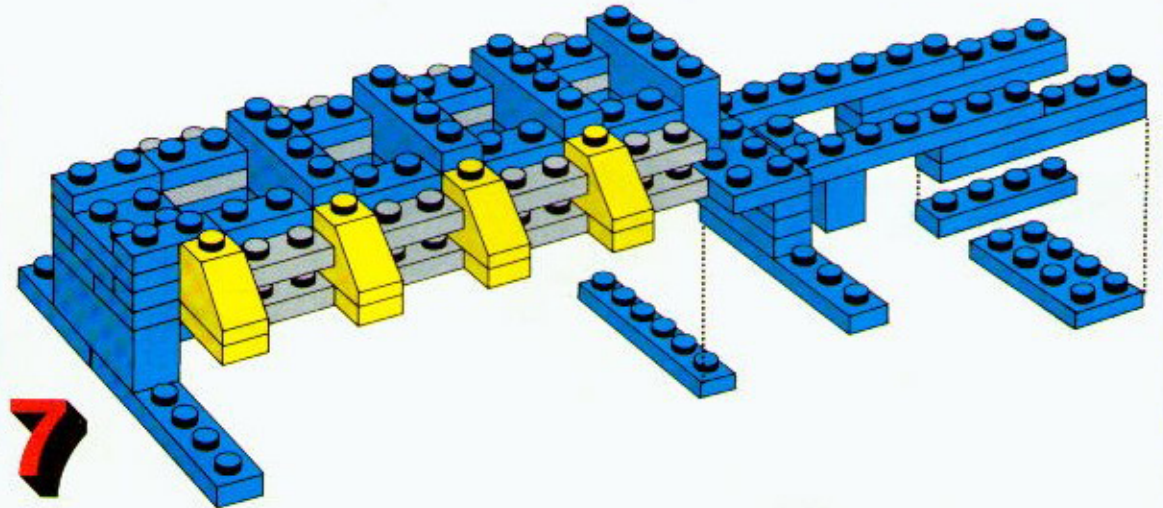
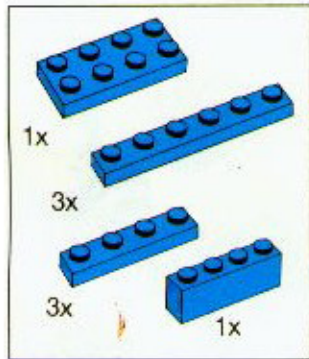
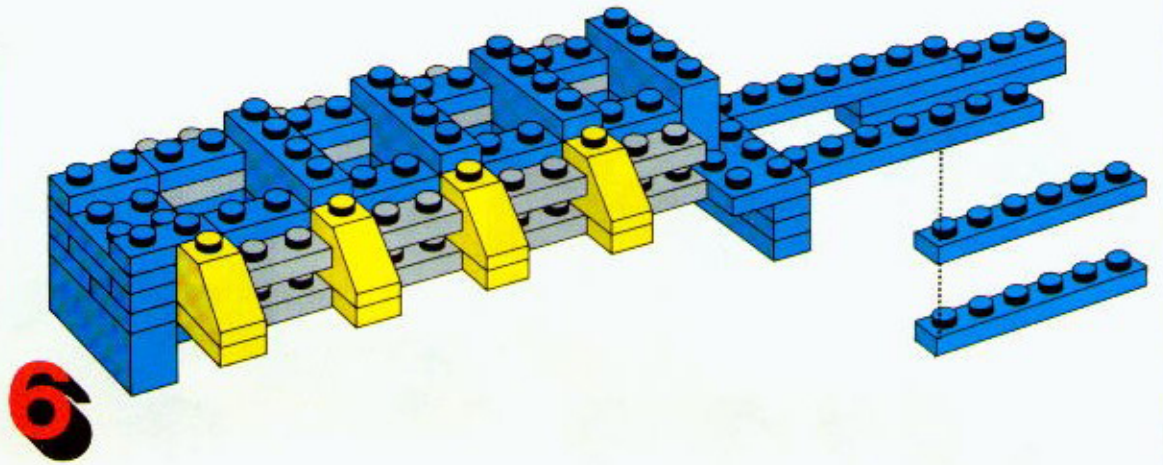
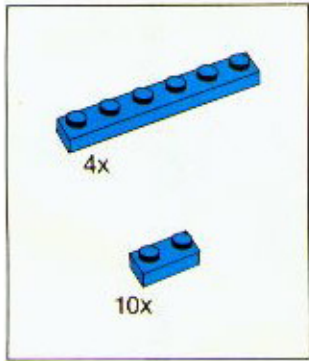

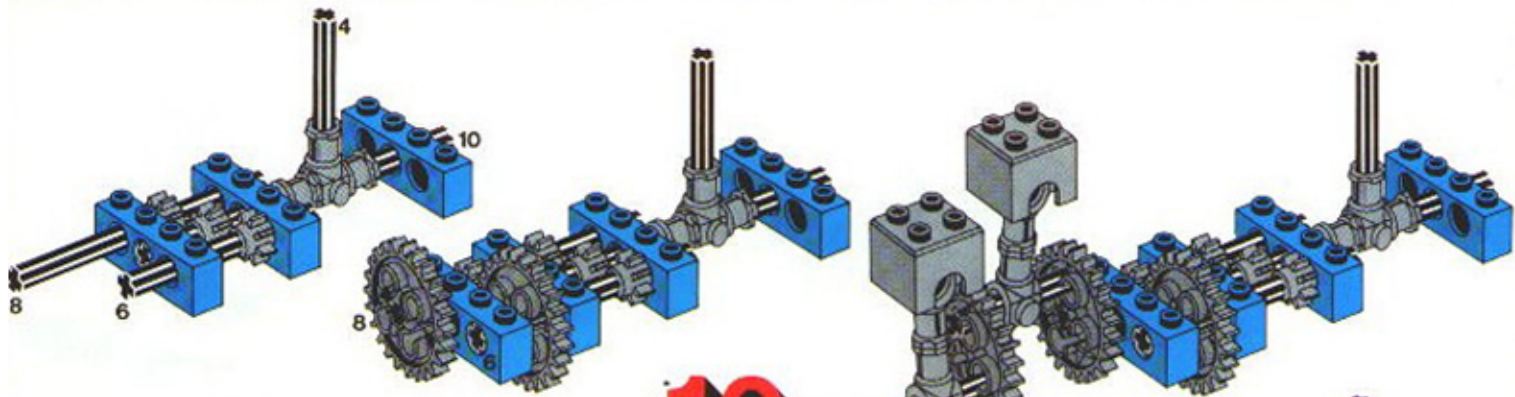

10

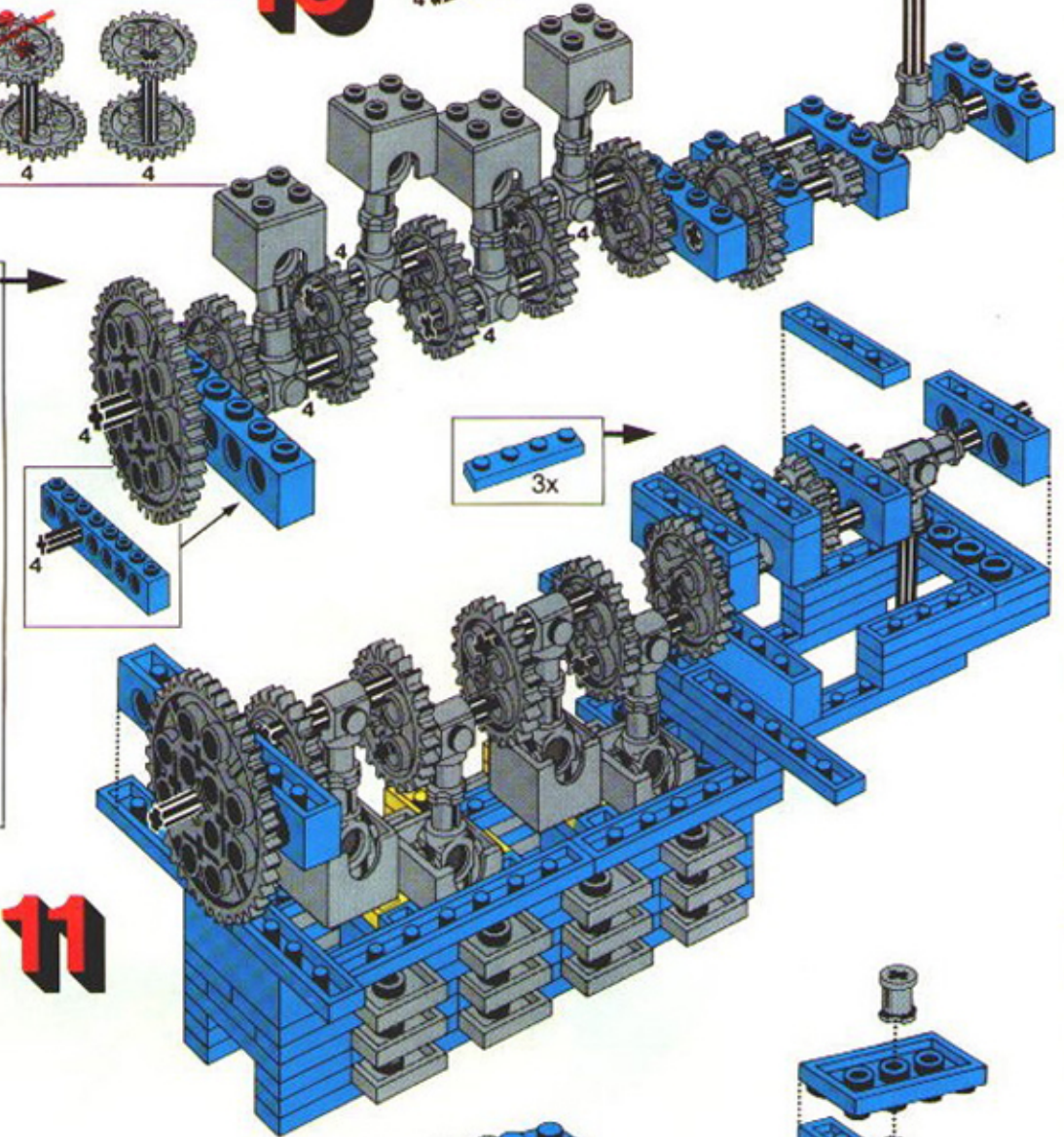
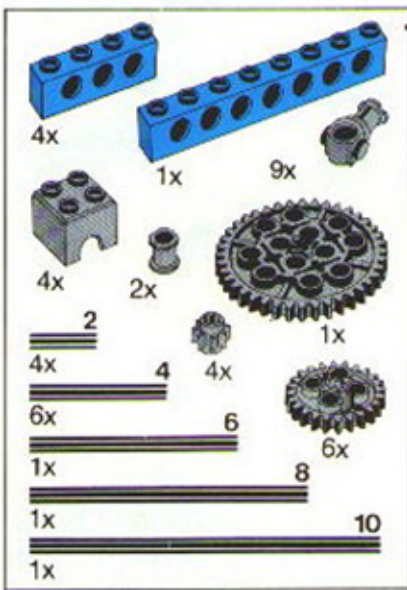
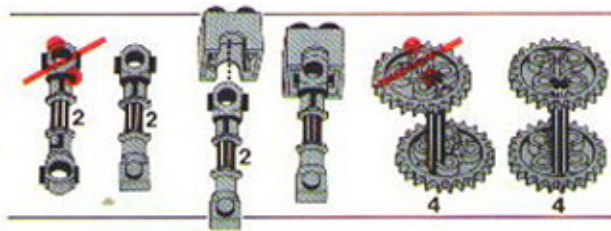

11

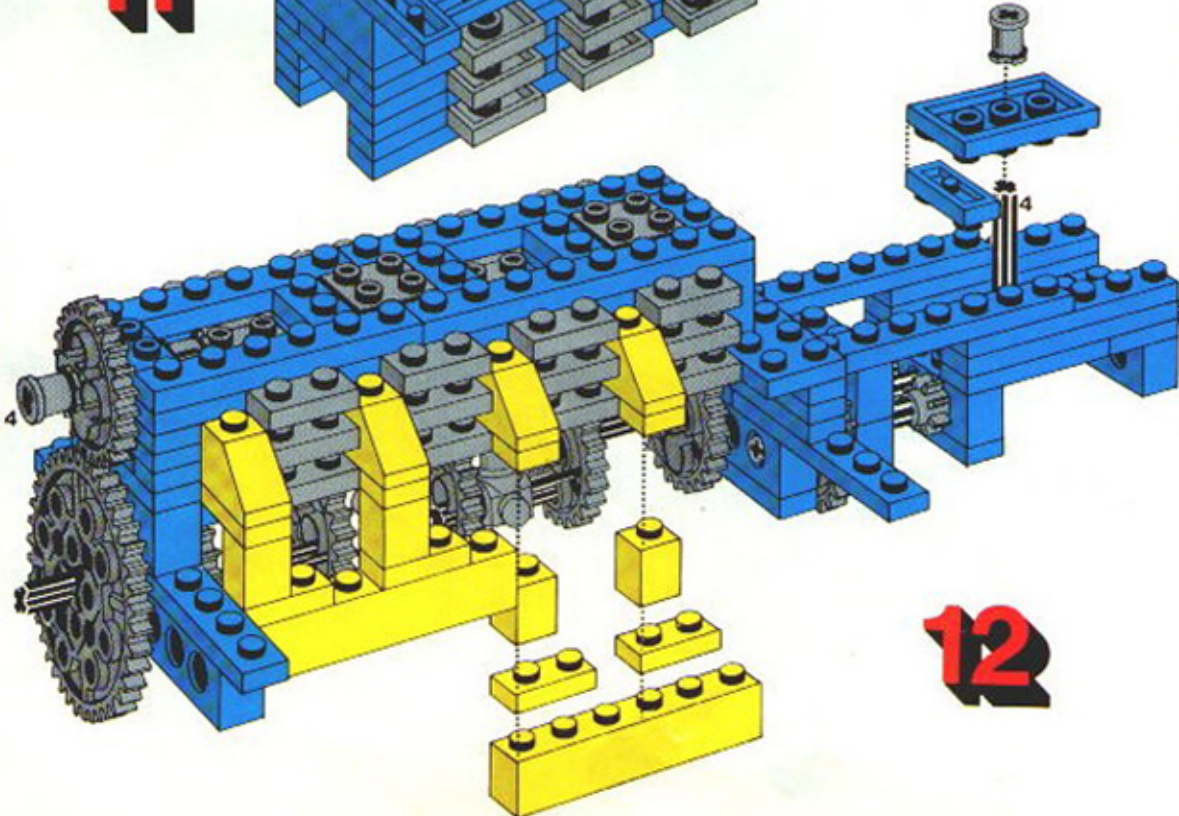
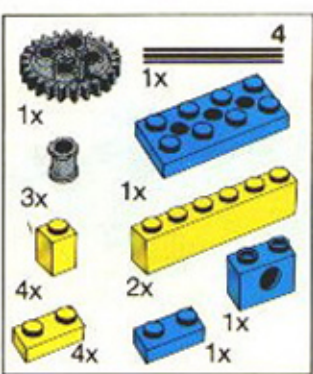

12

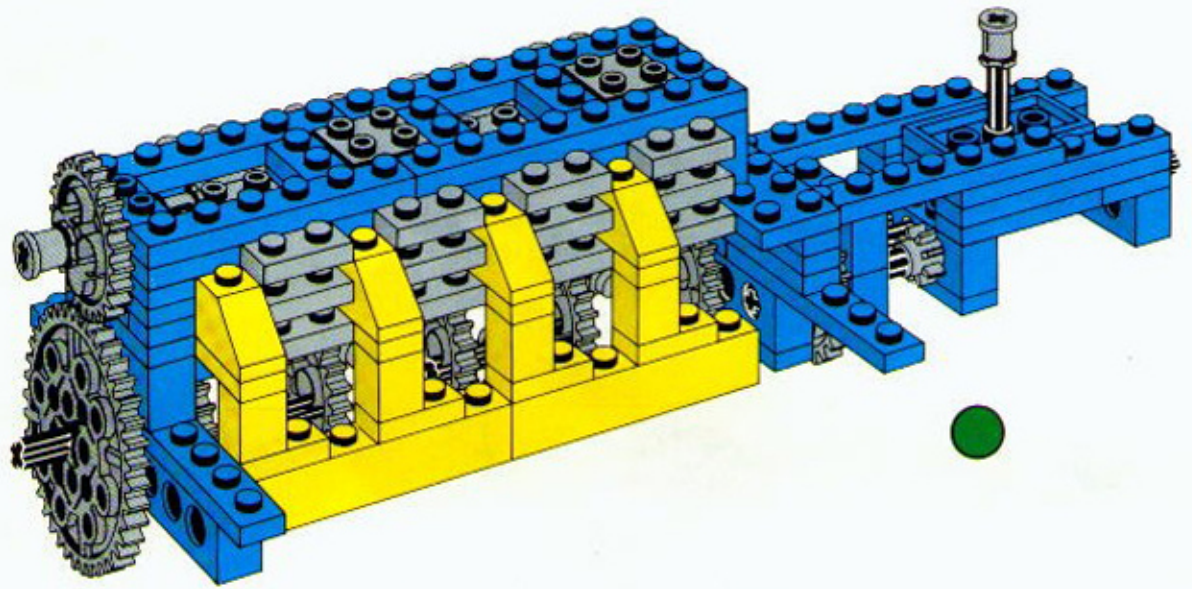

1

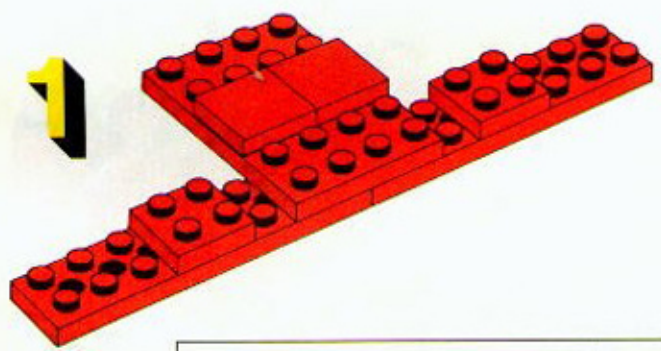

2

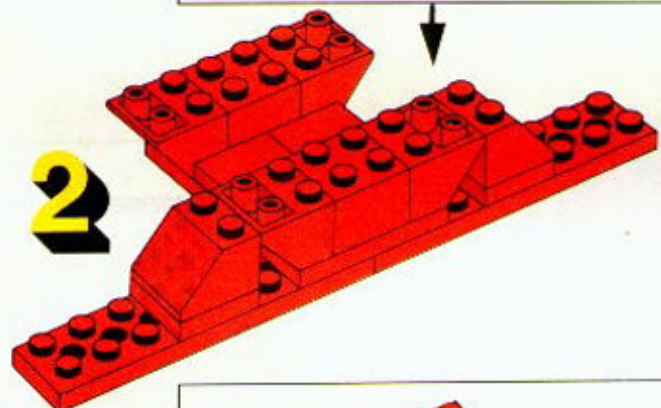

3

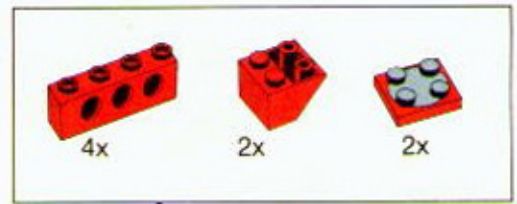
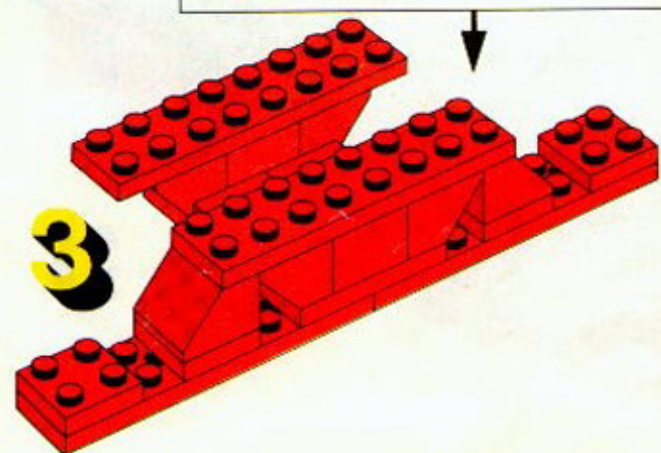

4

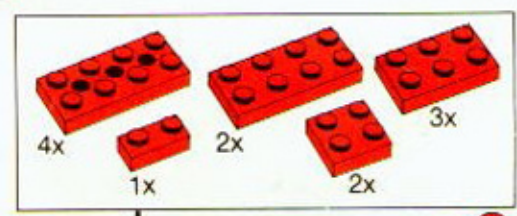
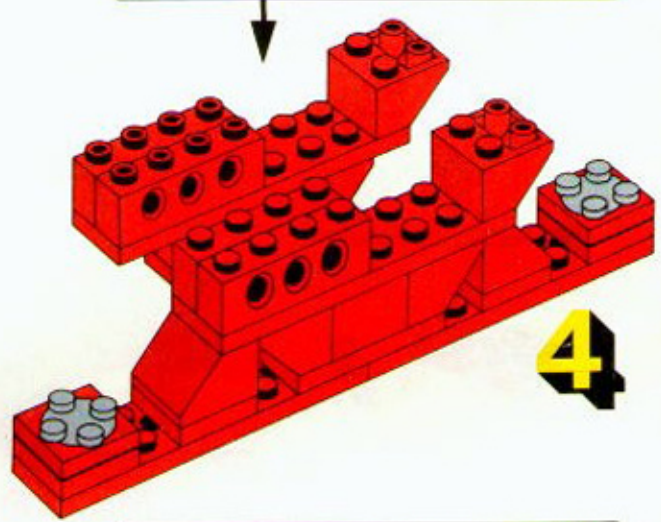

5

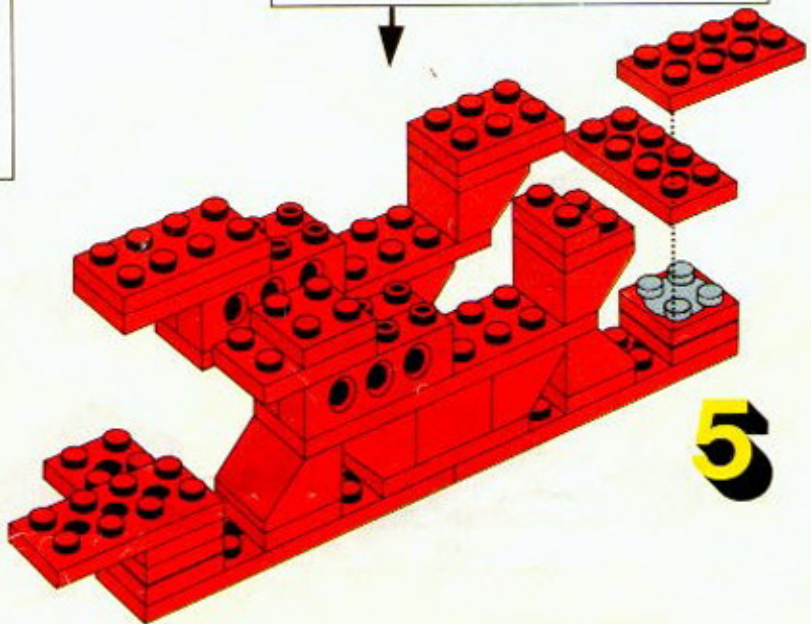

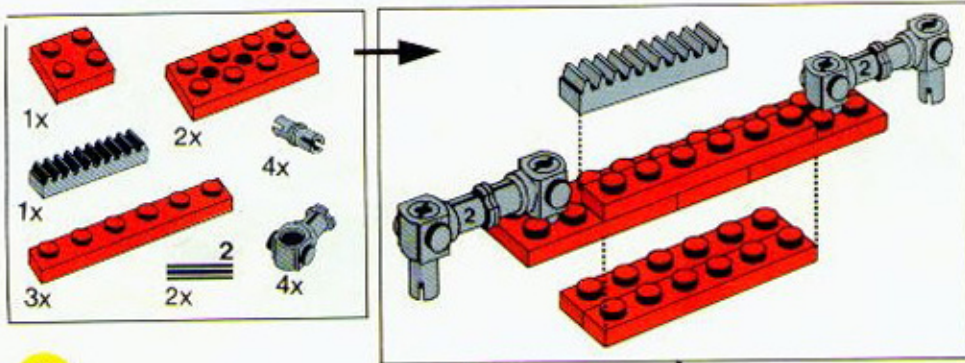

6

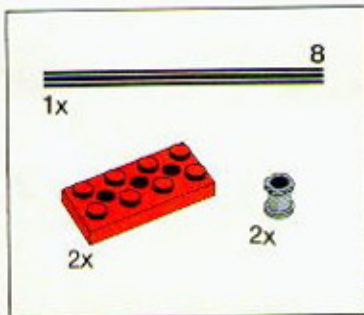
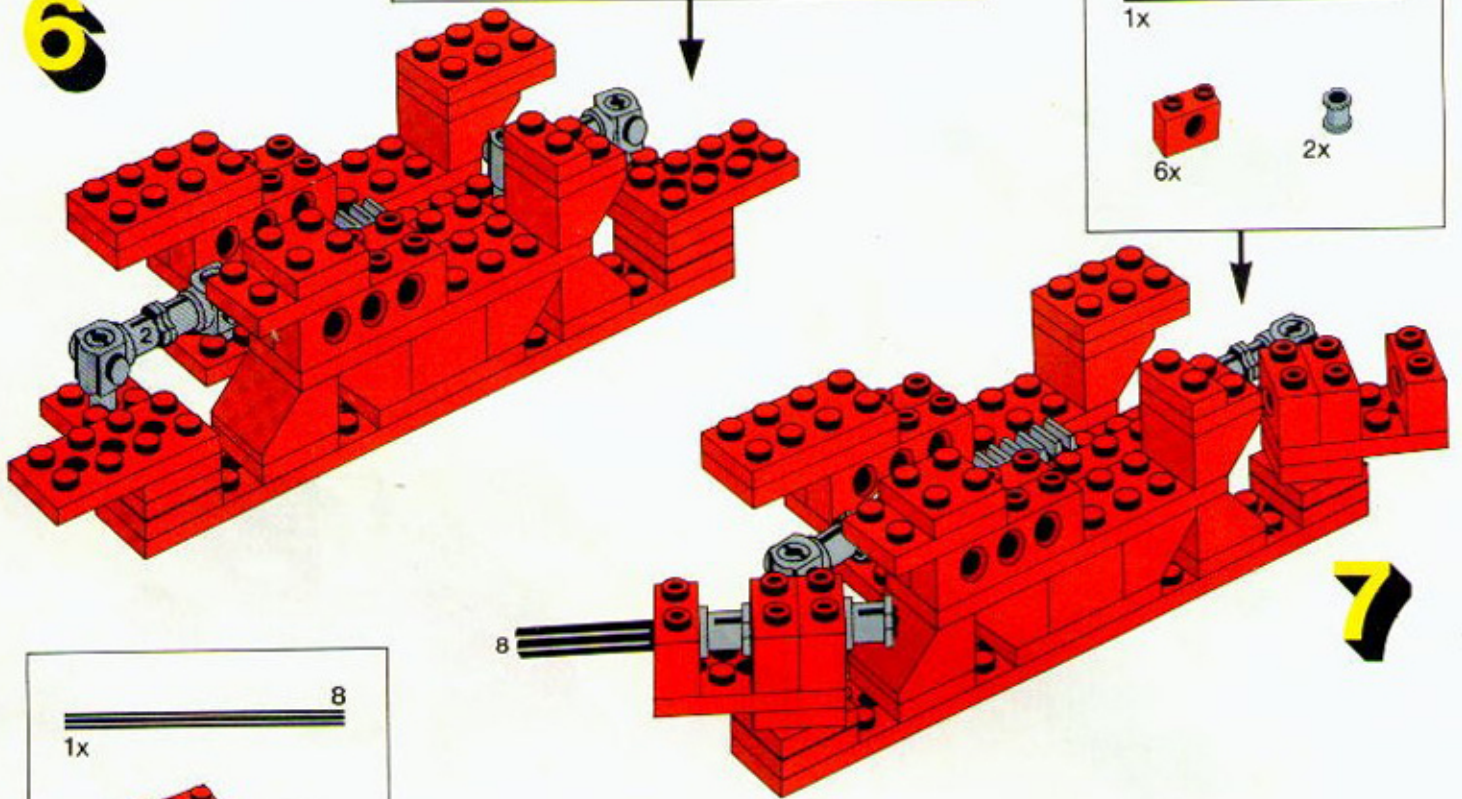
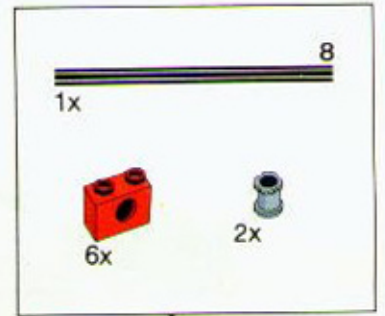

8

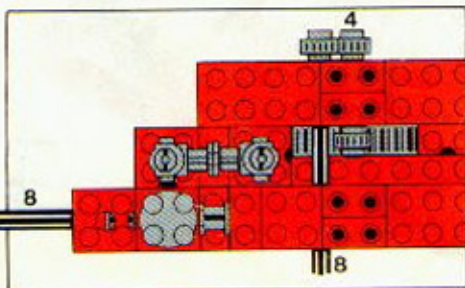
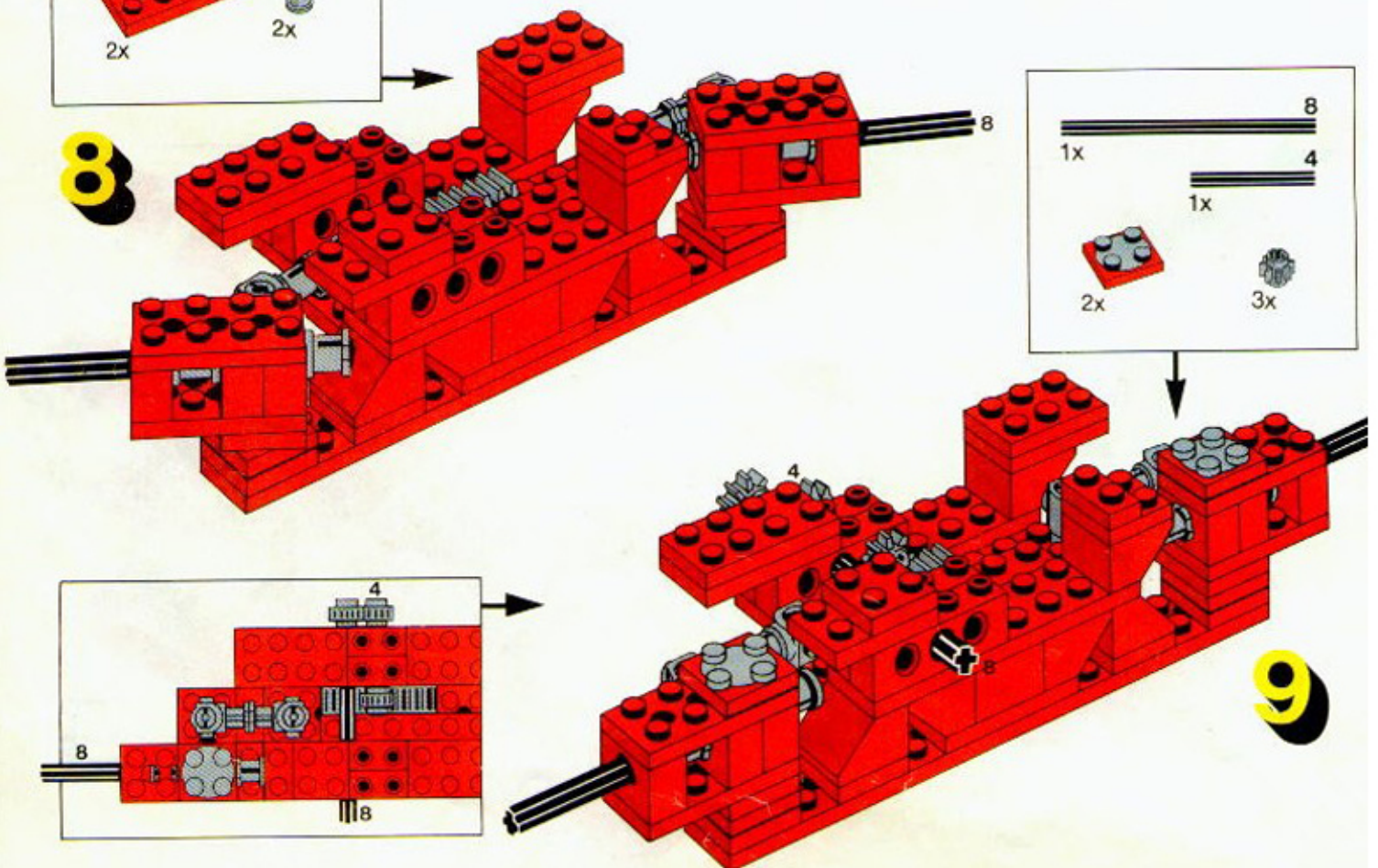
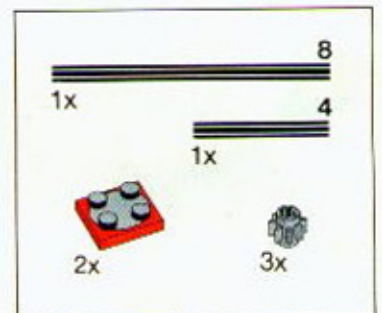

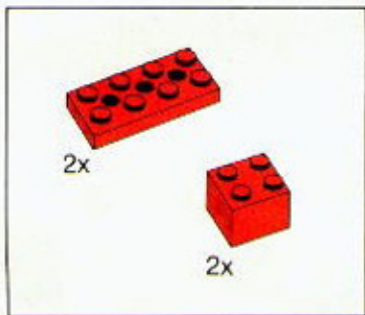

10

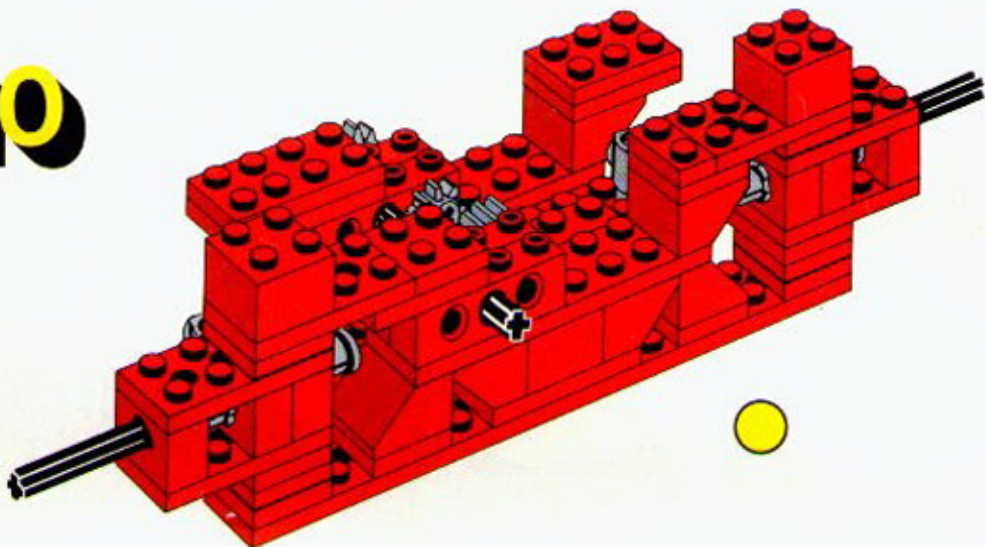

1

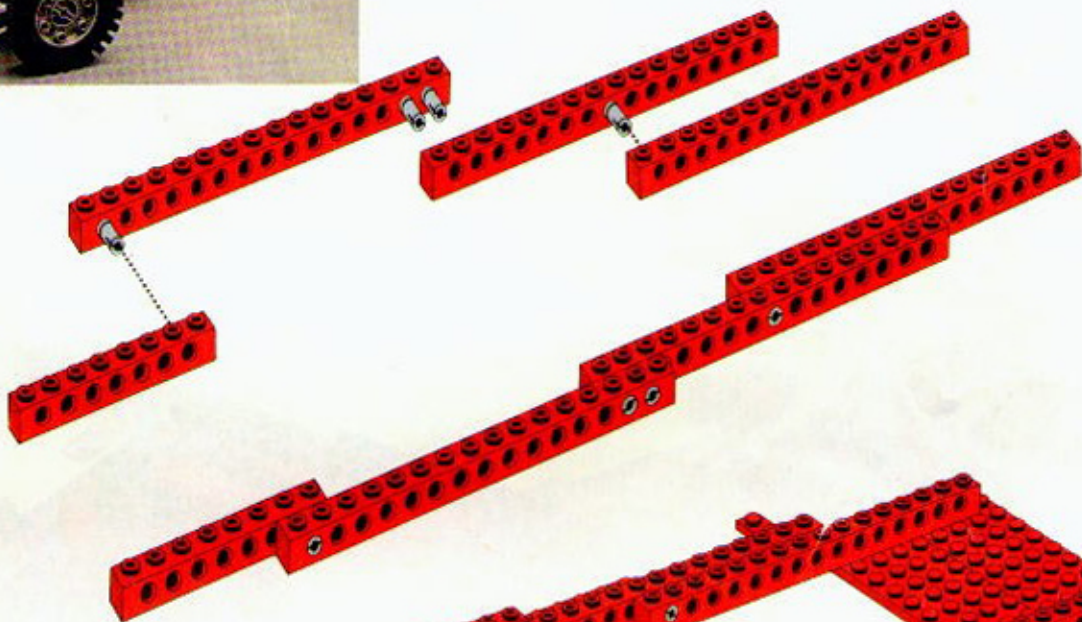

2

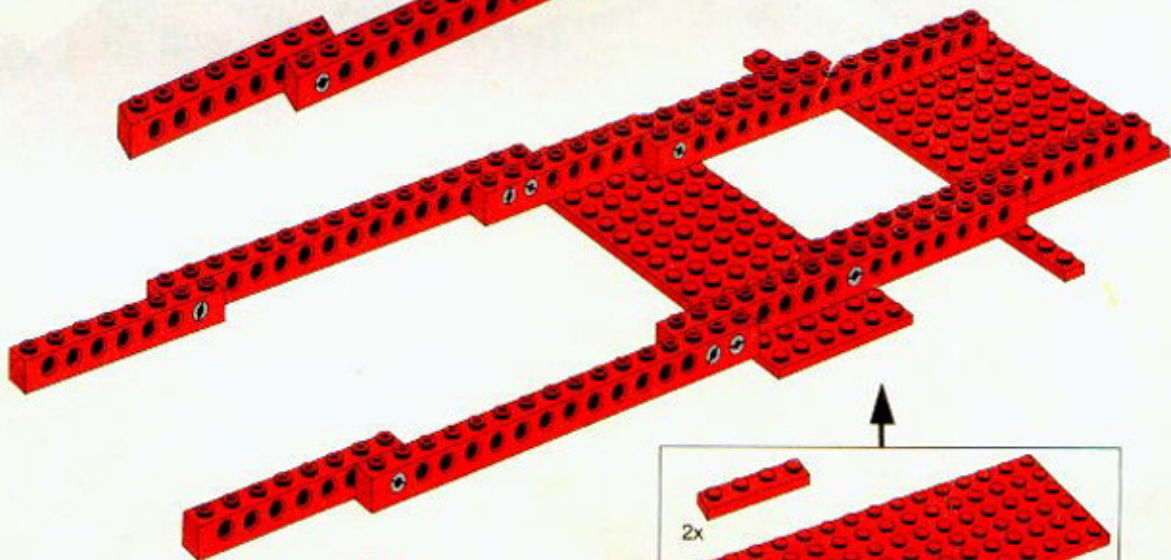

3

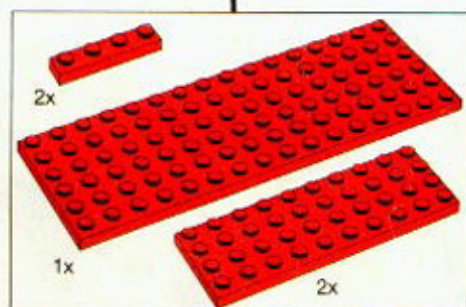

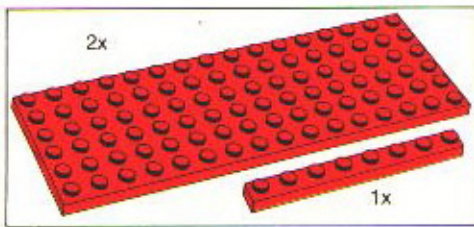

4

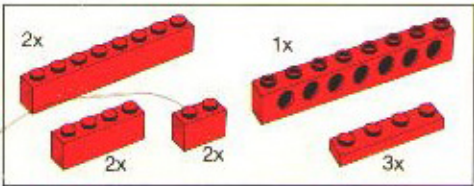
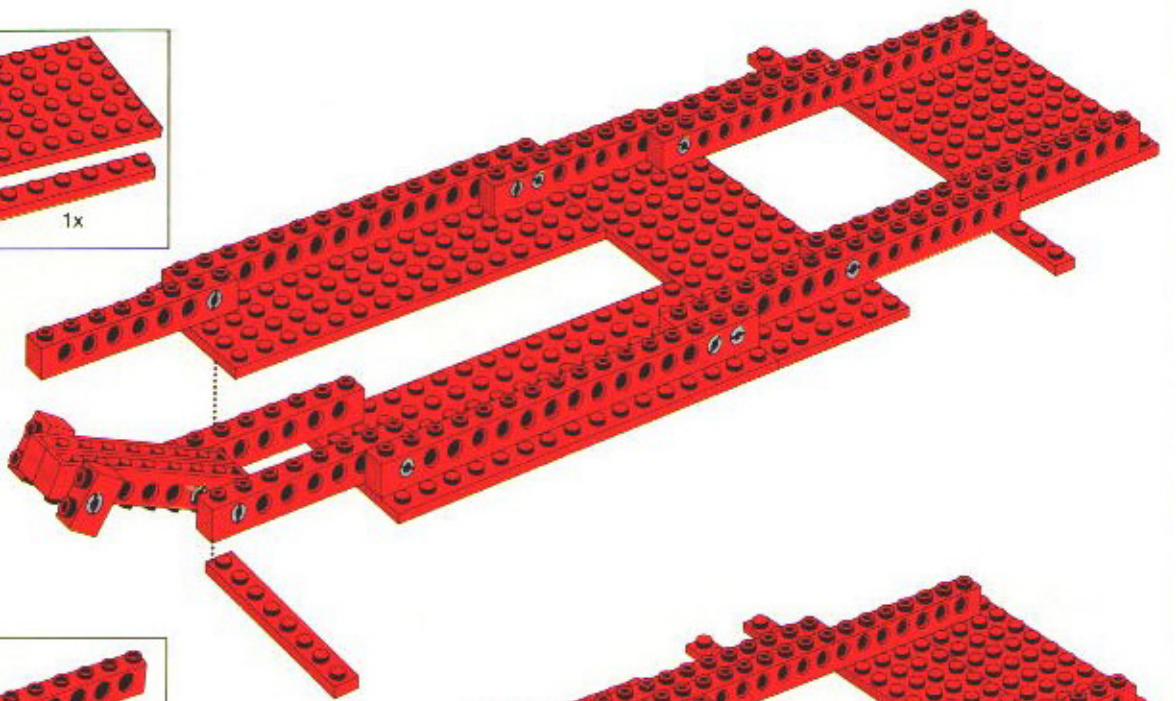

5

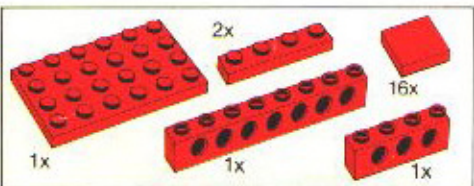
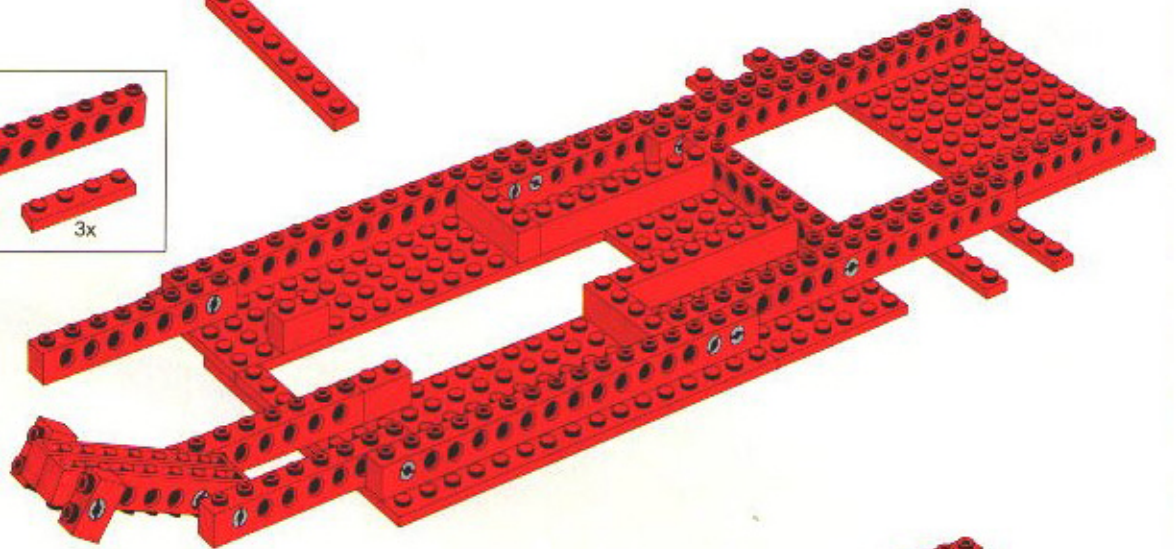

6

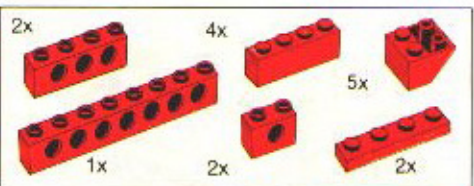
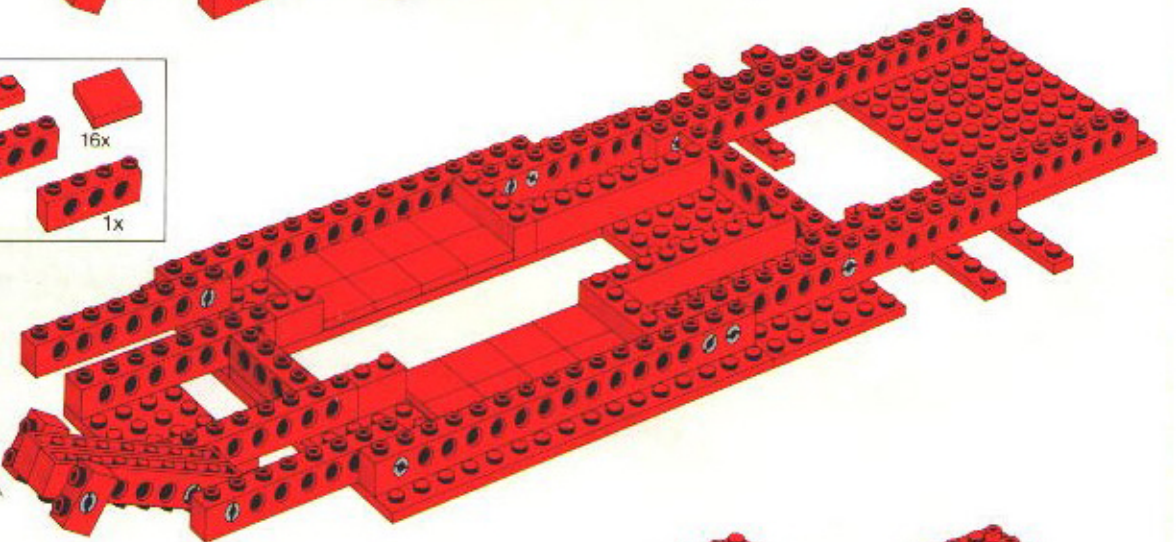

7

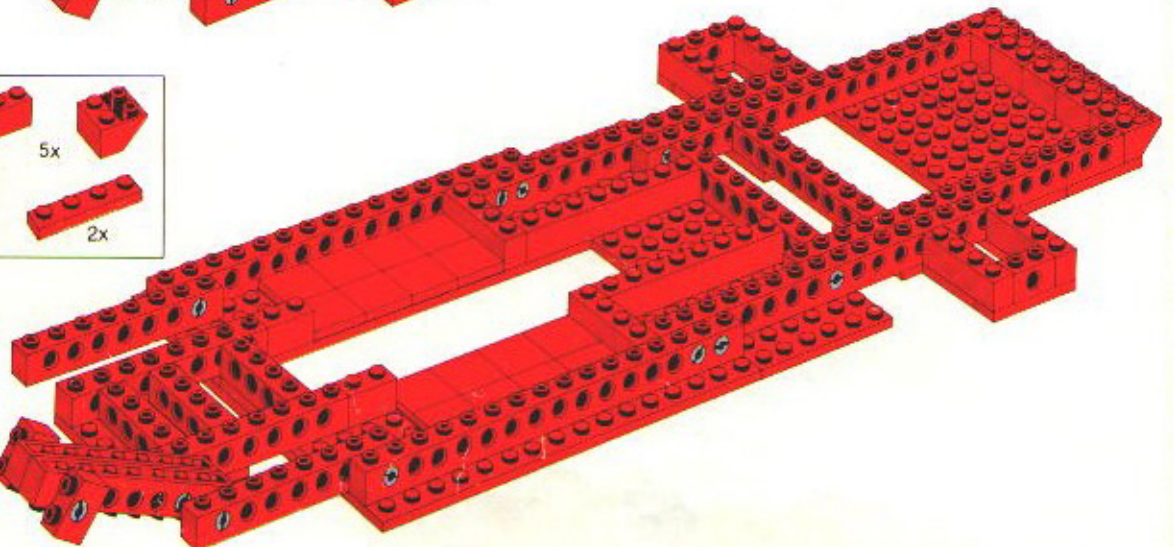

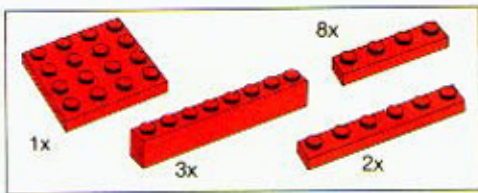

8

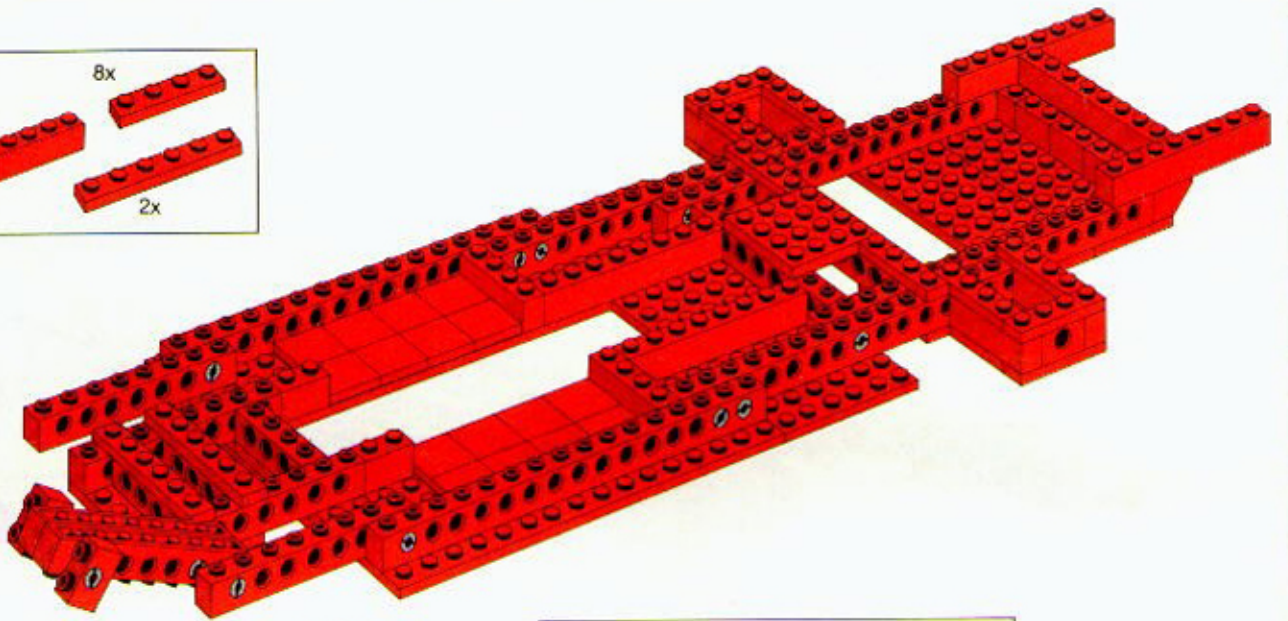

9

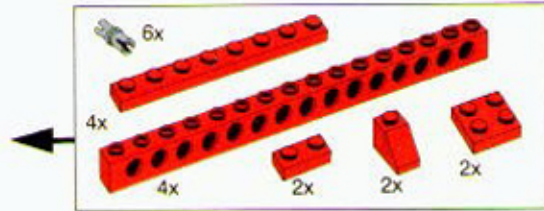
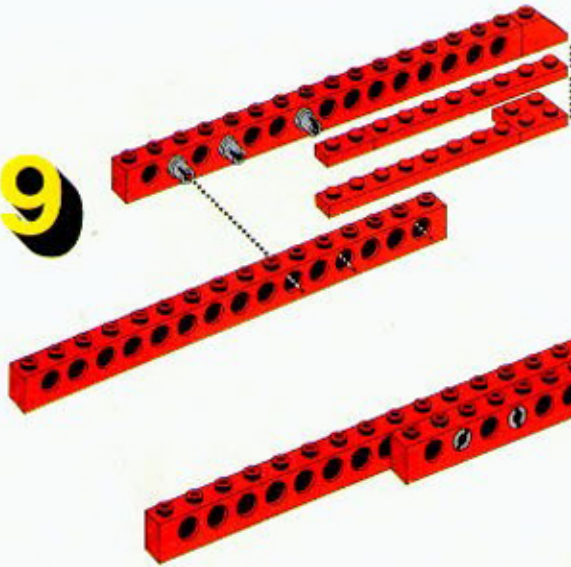

10

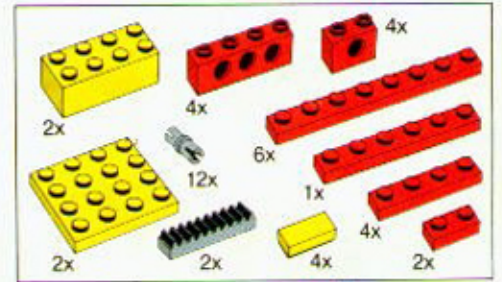
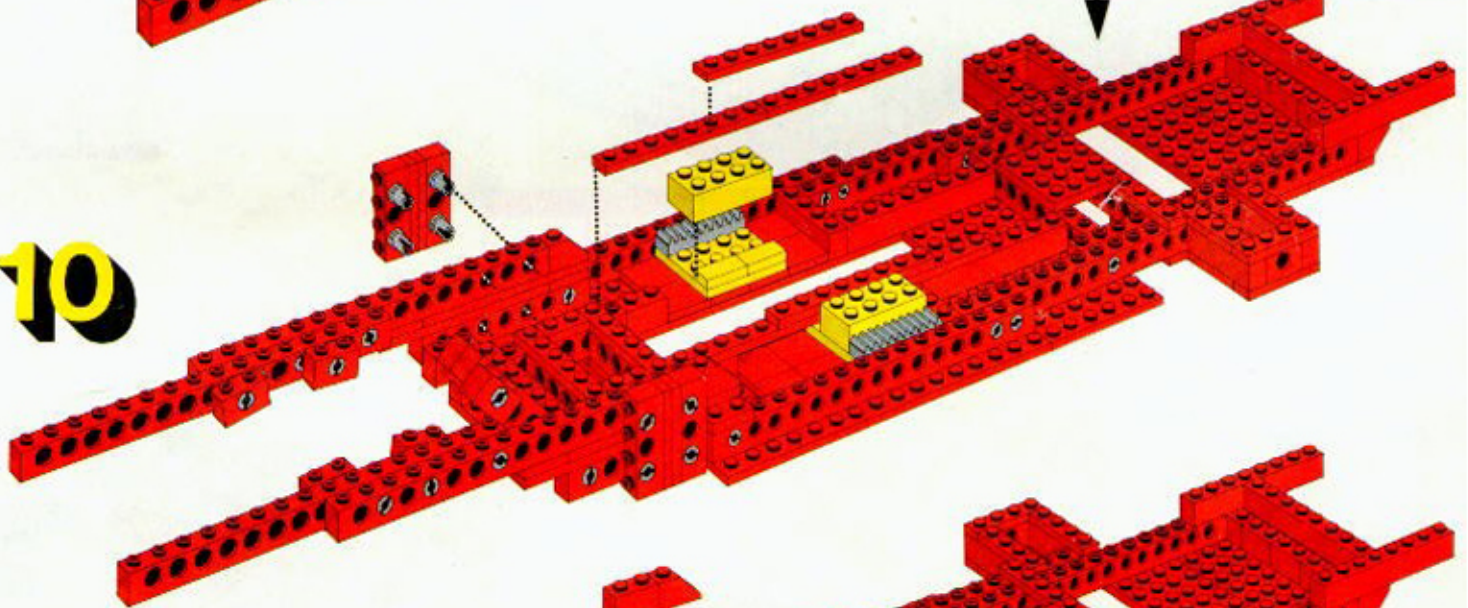

11

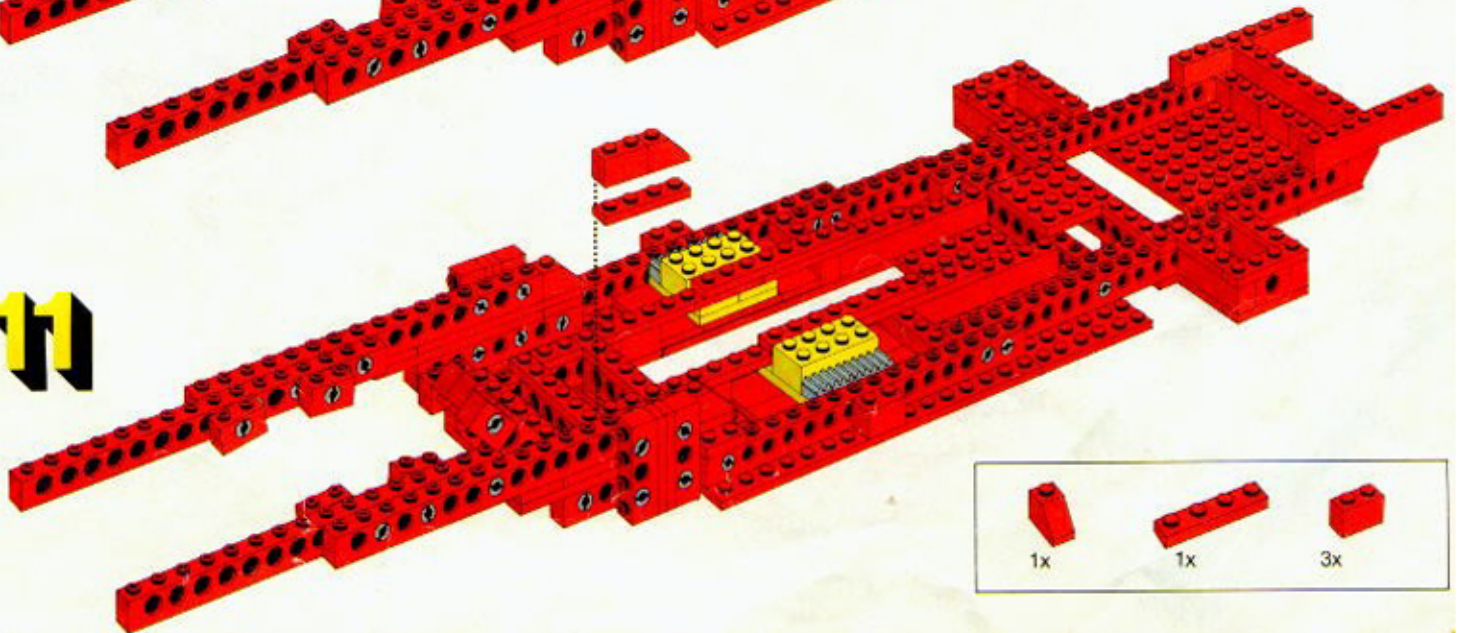

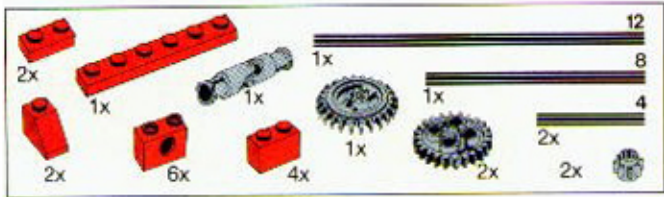

12

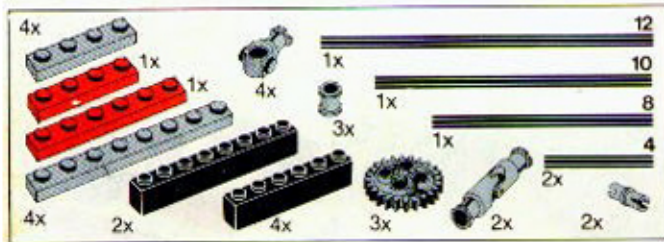
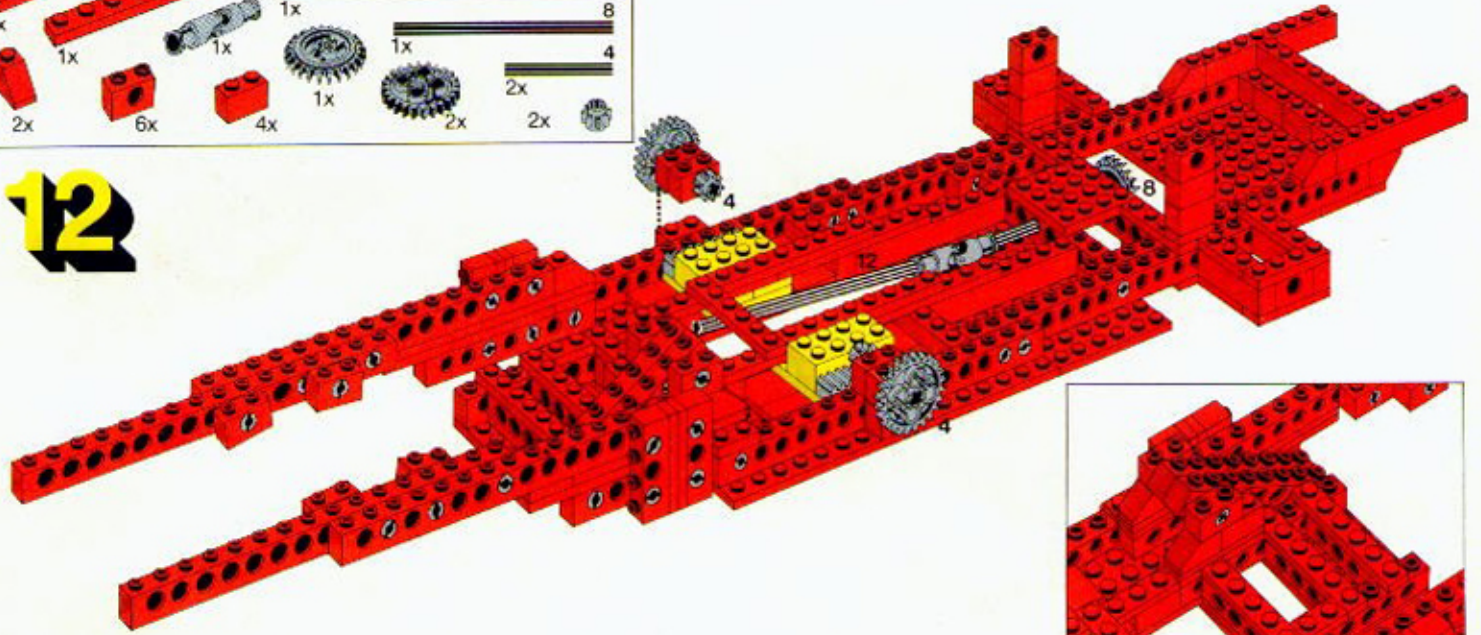

13

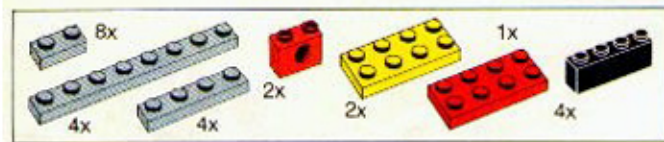
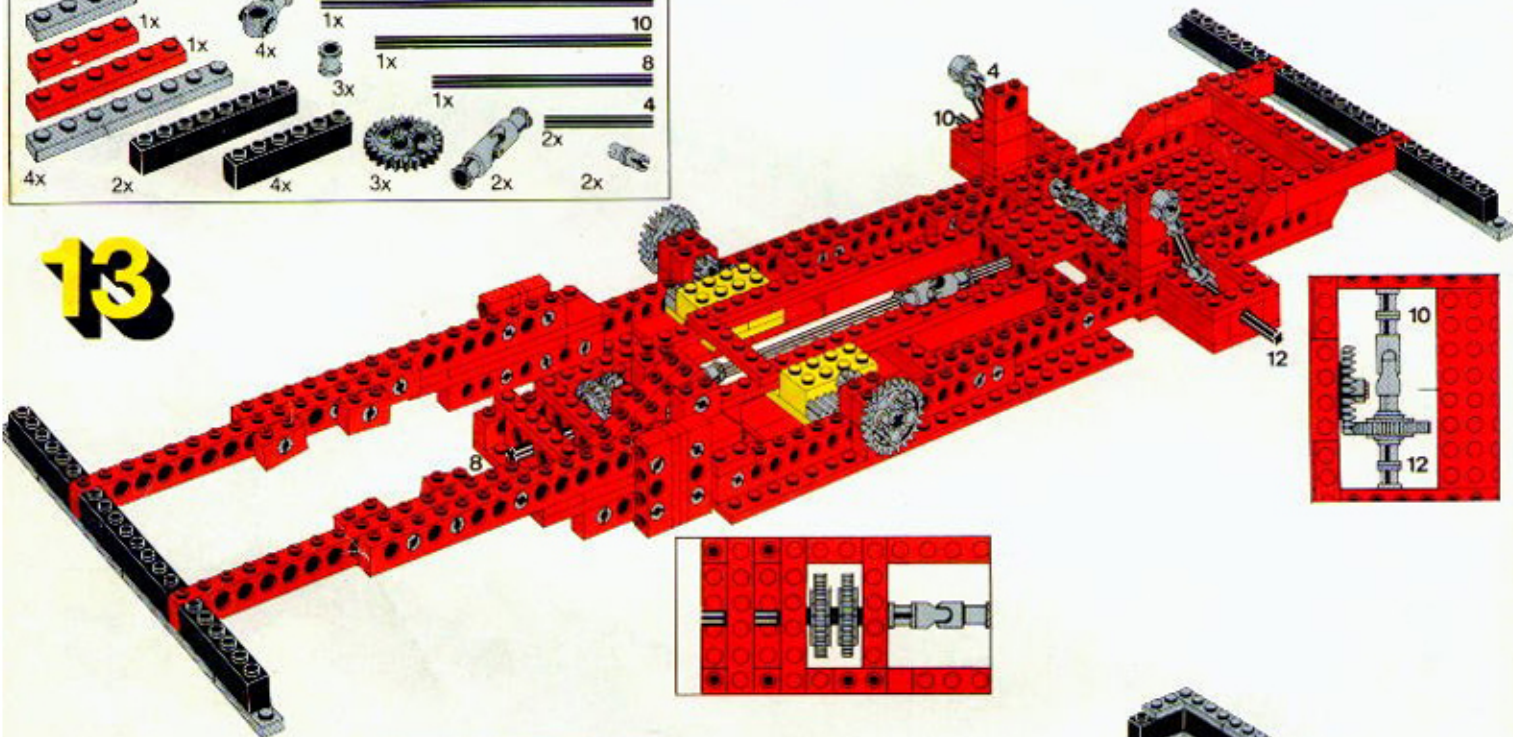

14

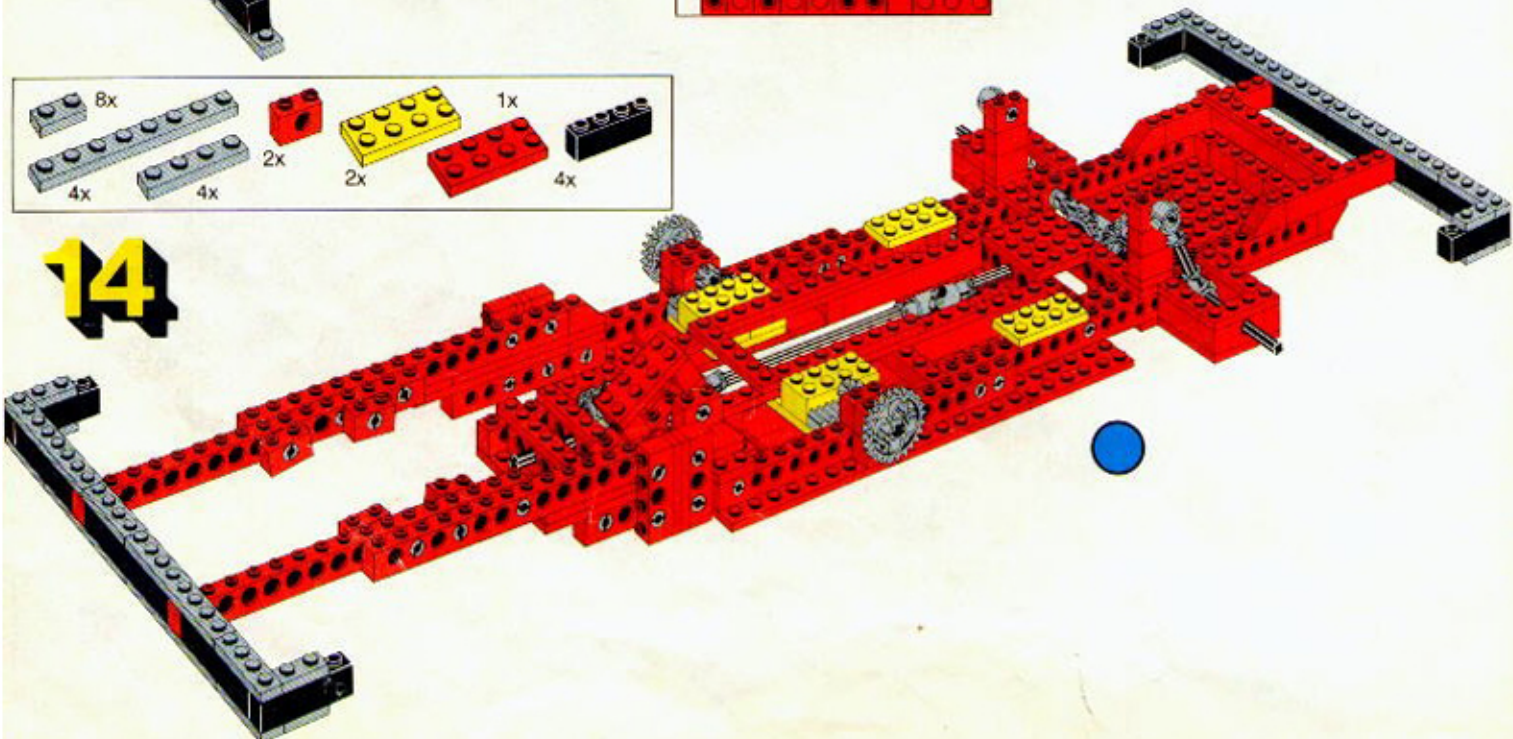

1

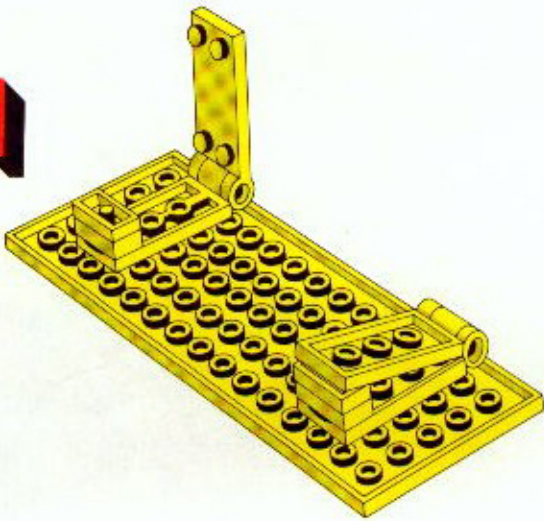

2

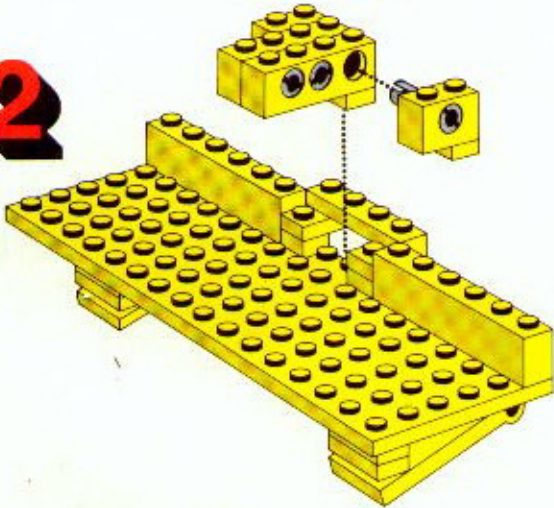

3

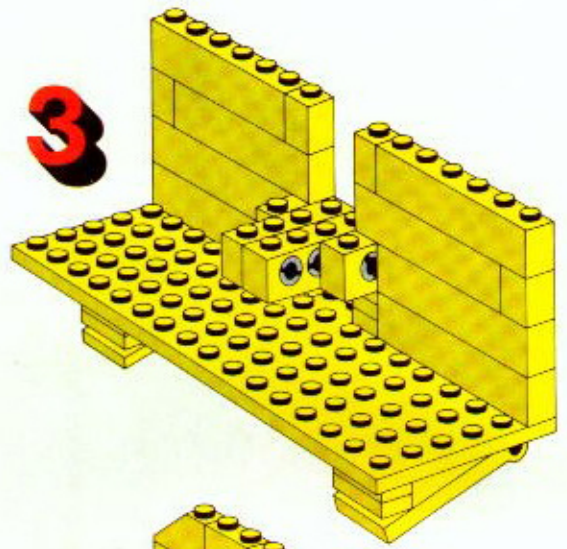

©

4

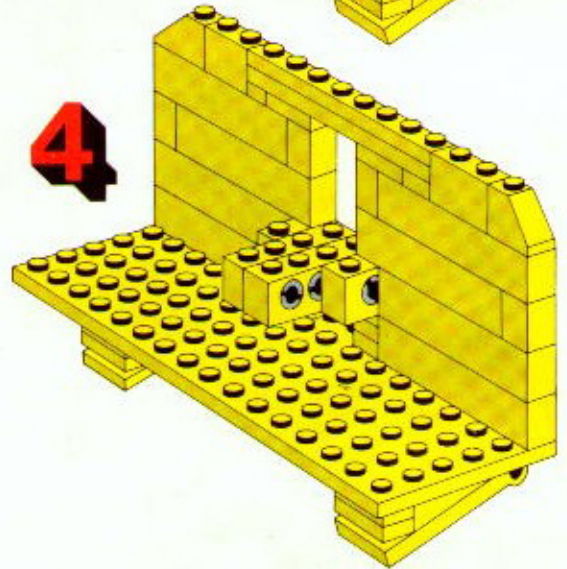

1

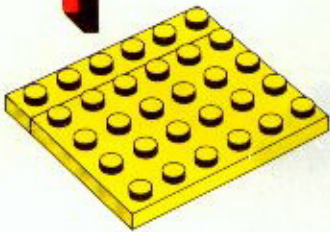

2

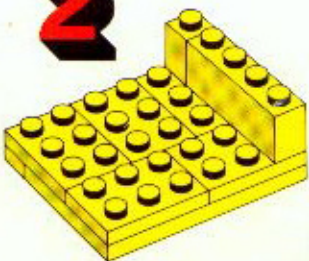

3

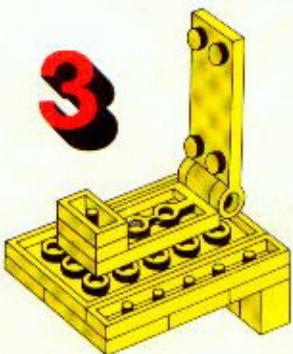

4

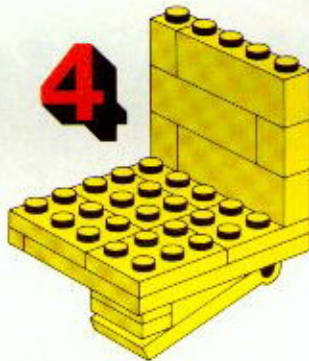

©

5

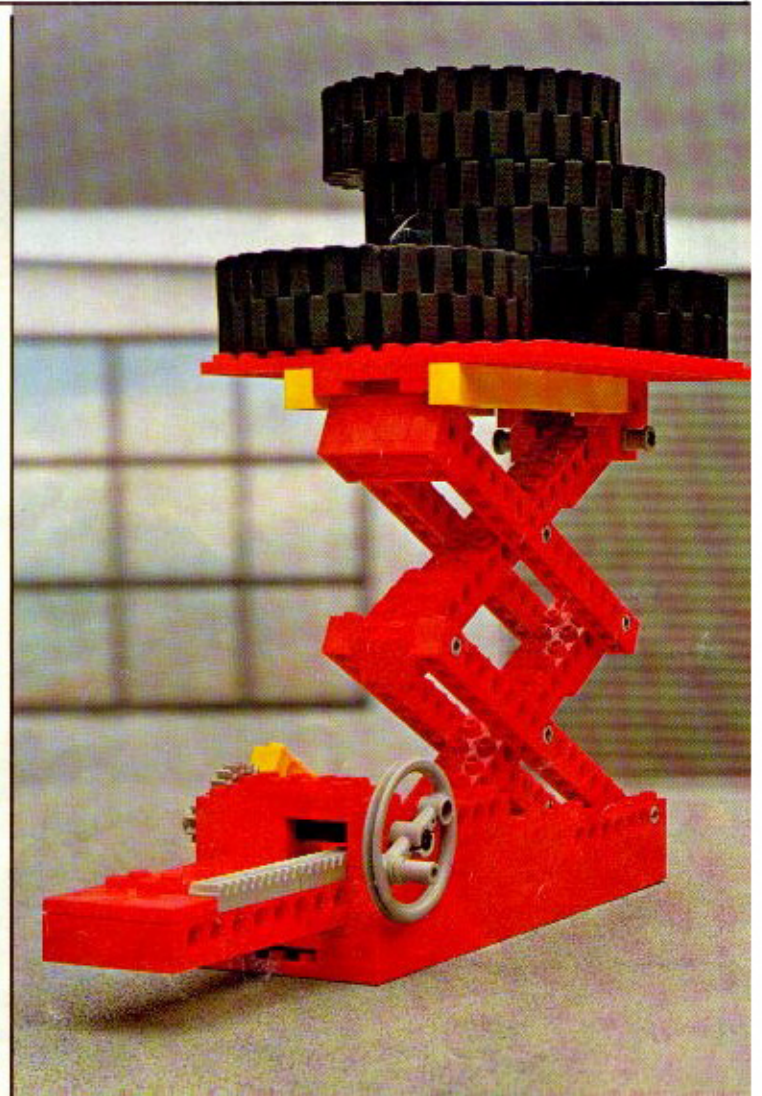

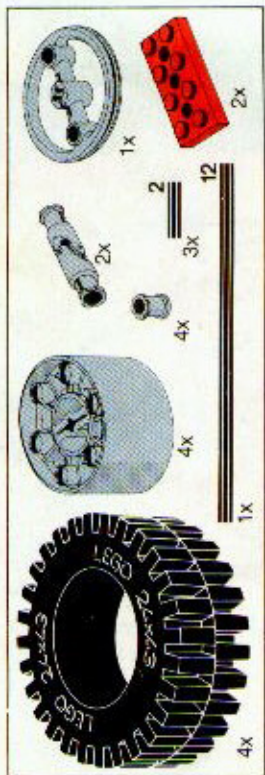
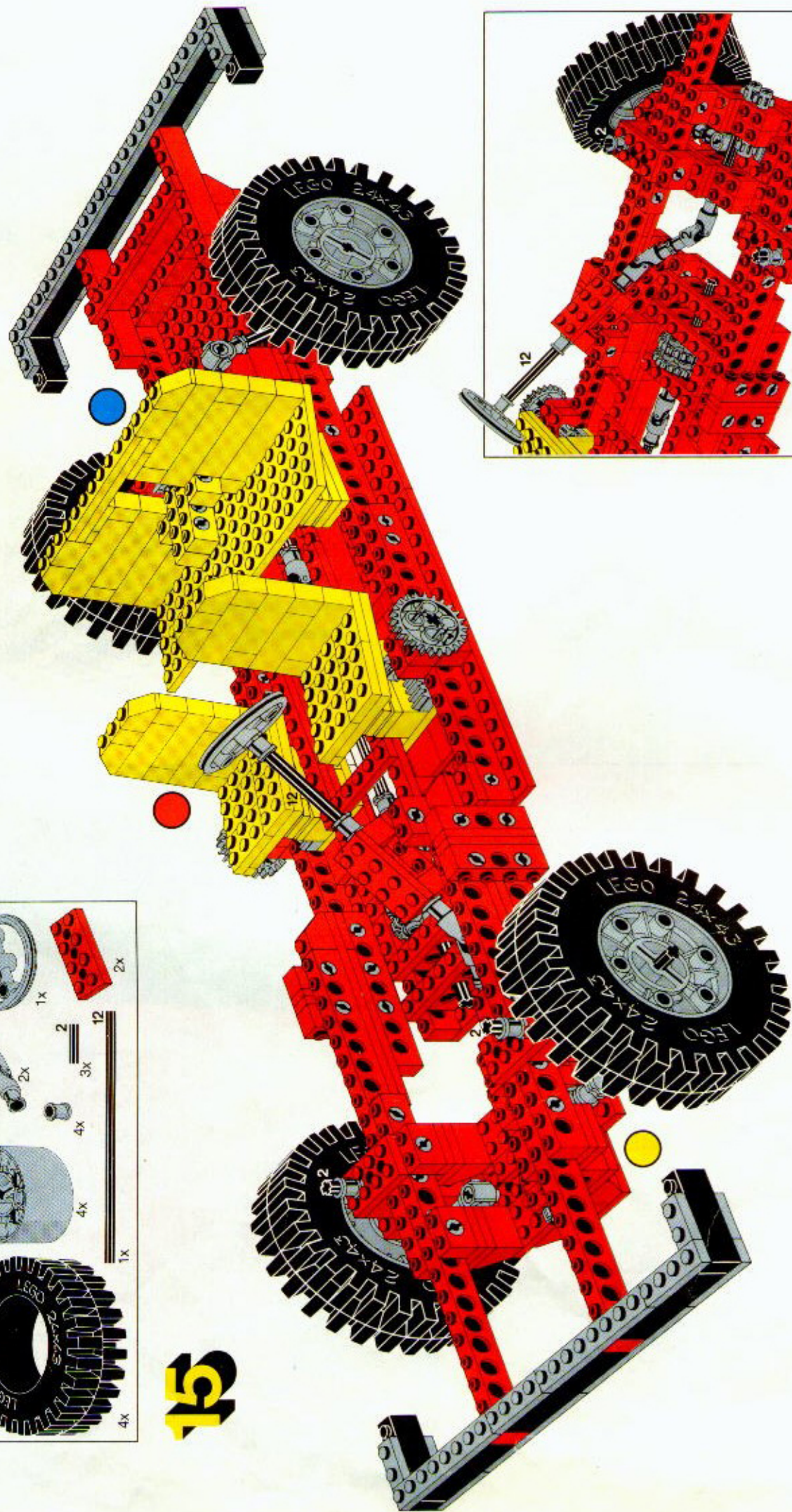
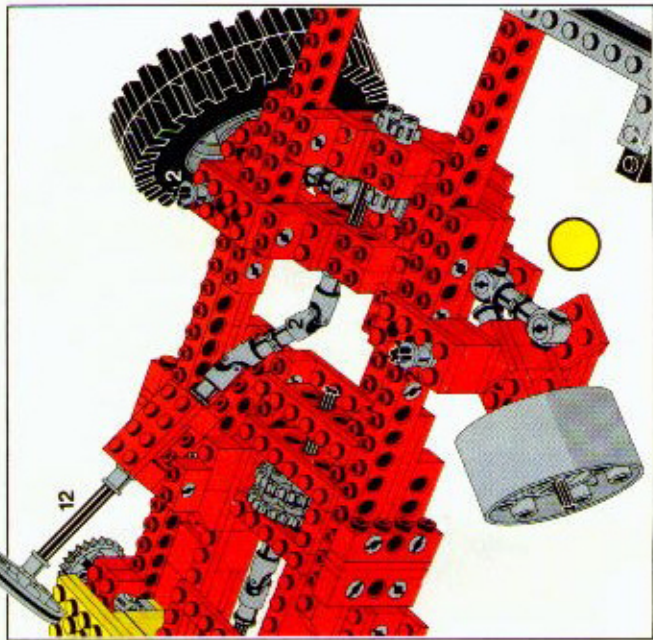

15

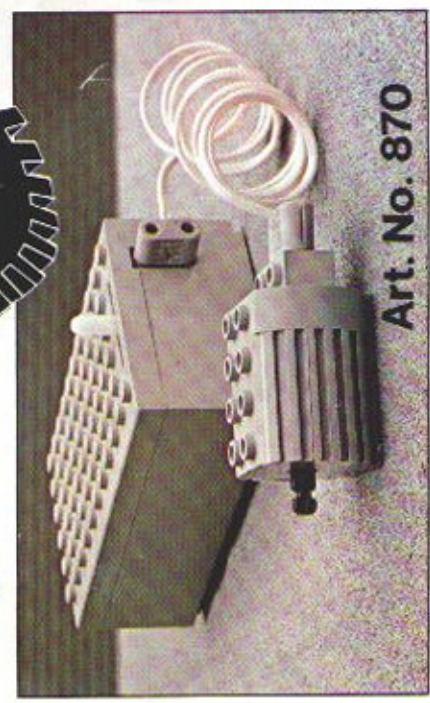
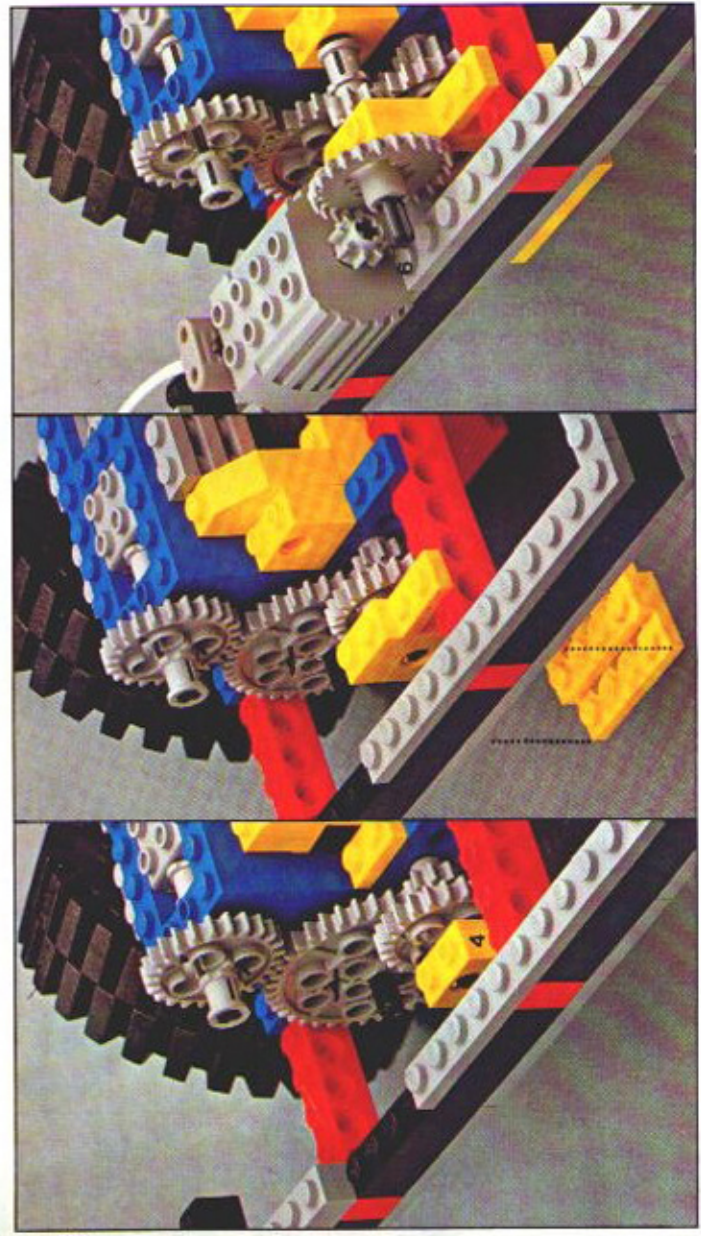
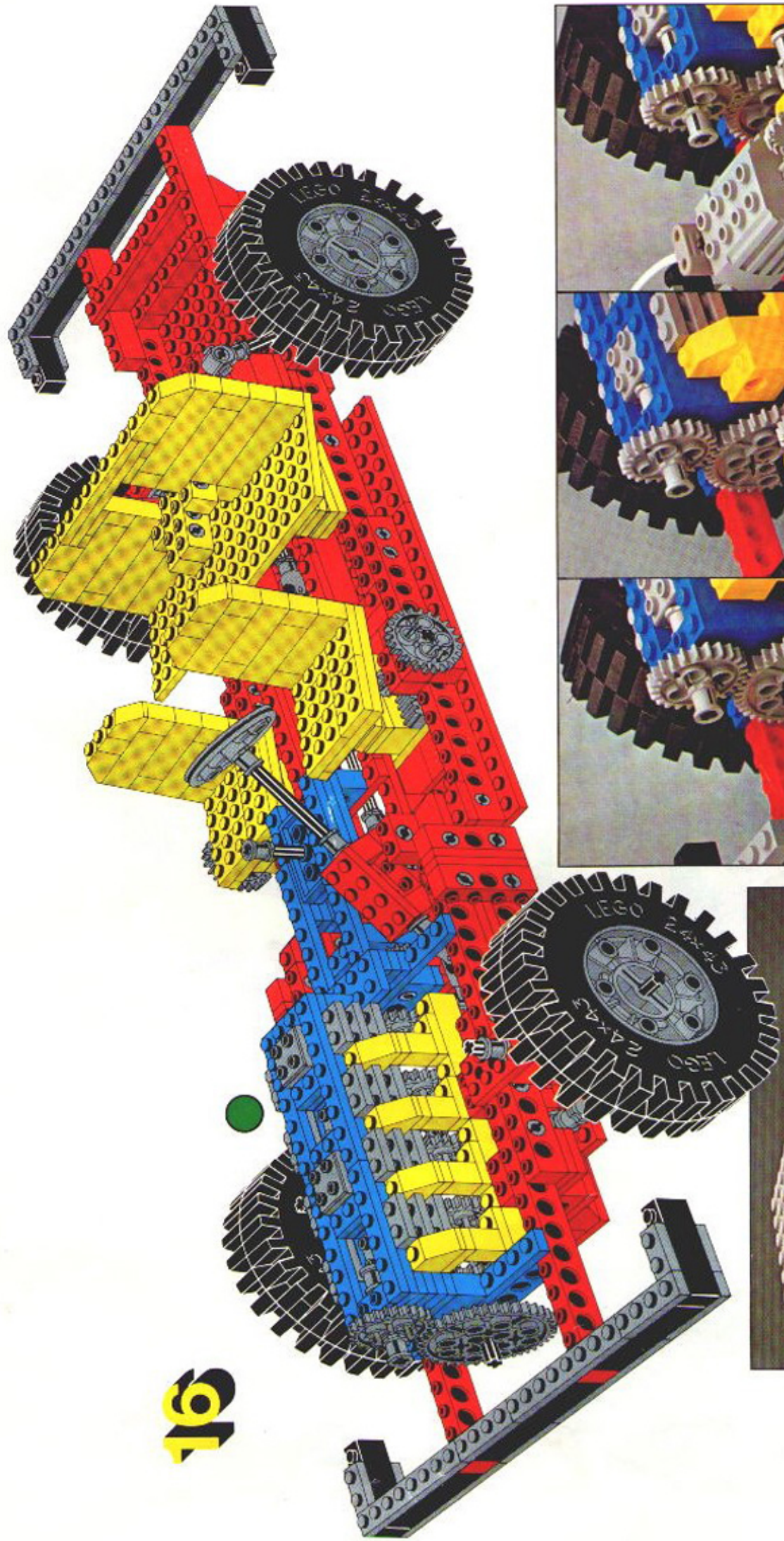

Art. No. 870

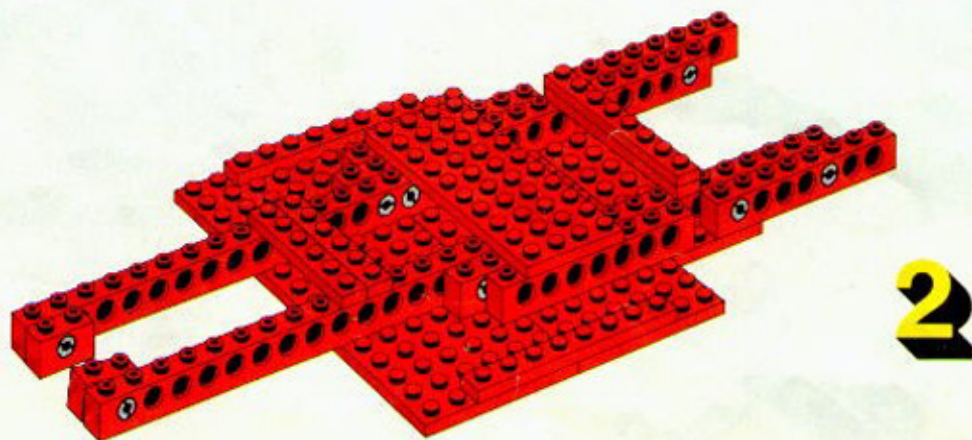
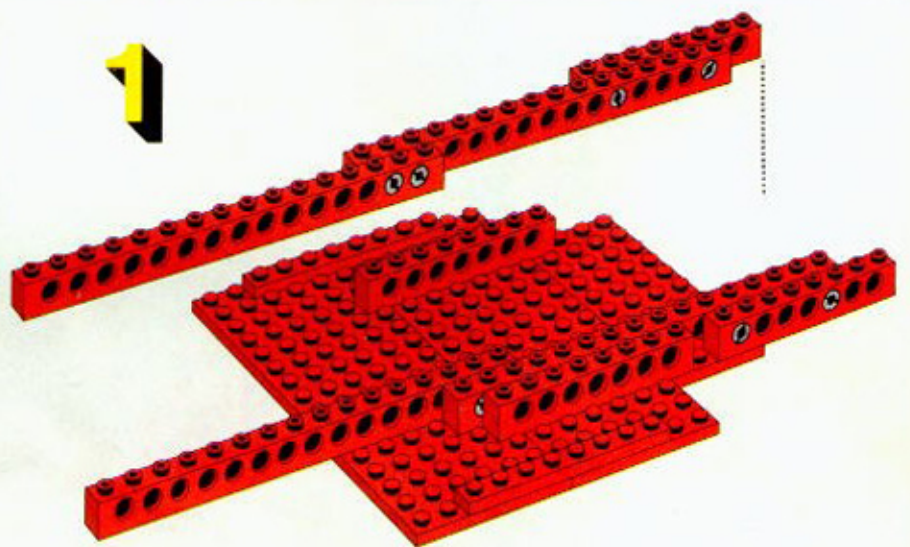
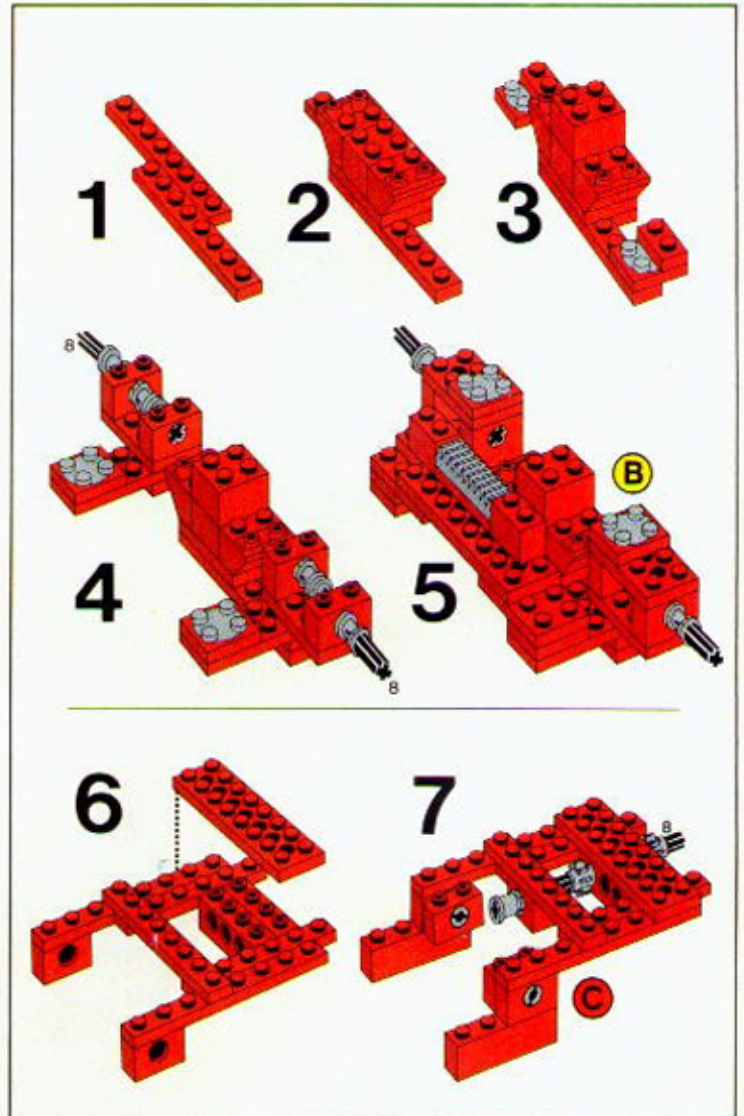
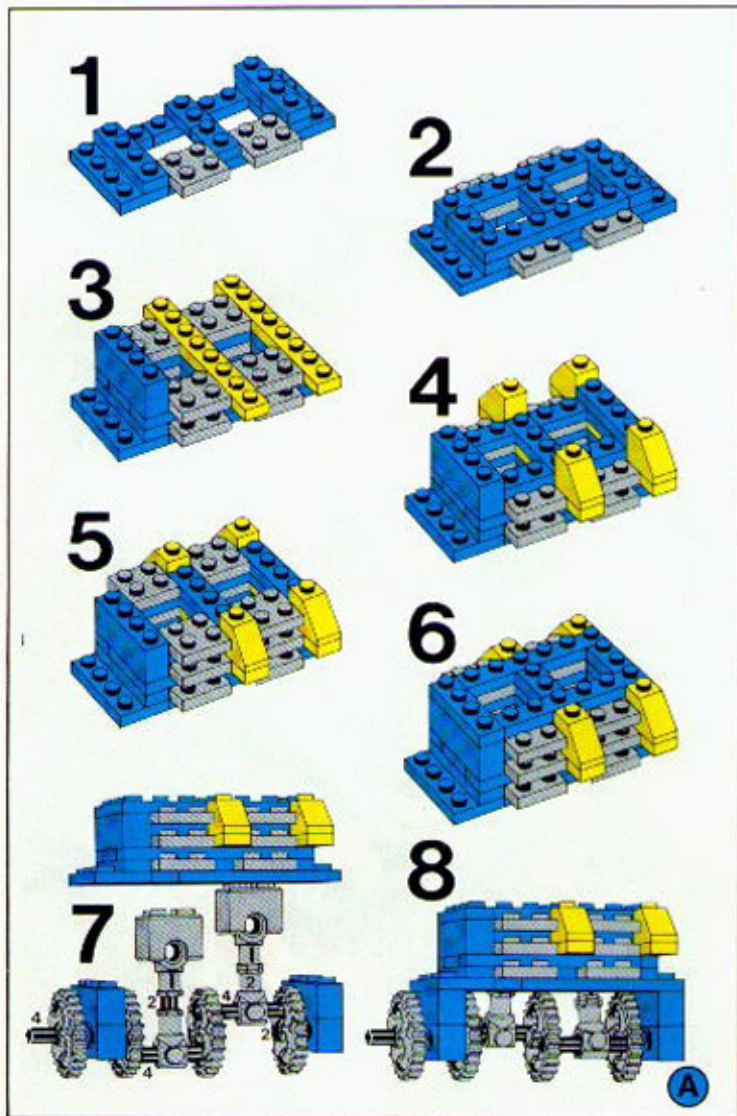

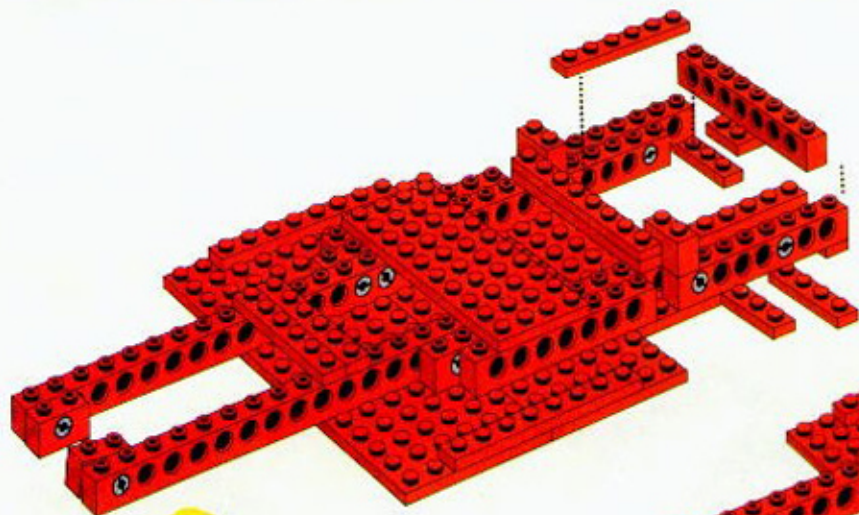

3

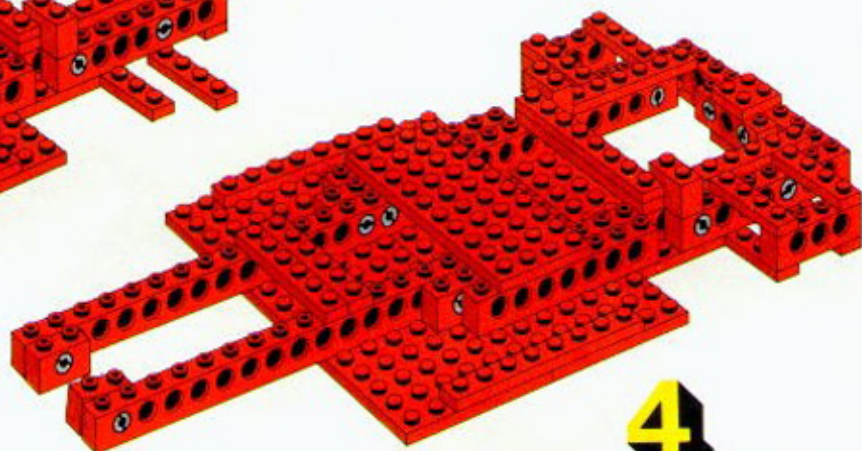

4

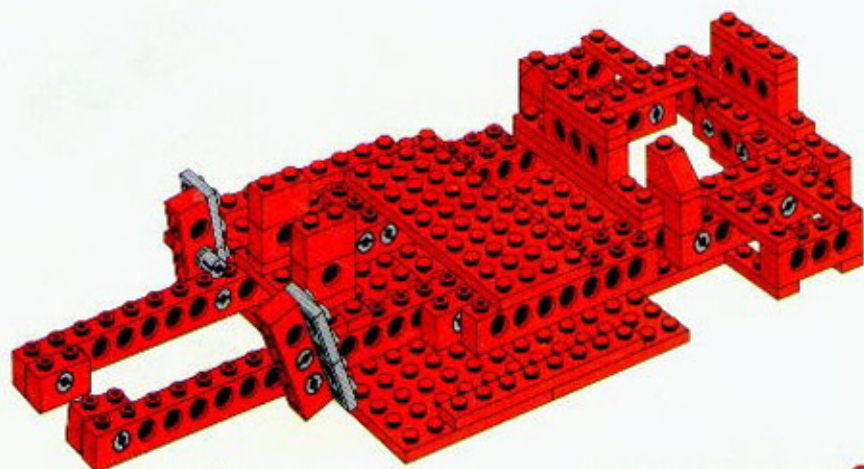

5

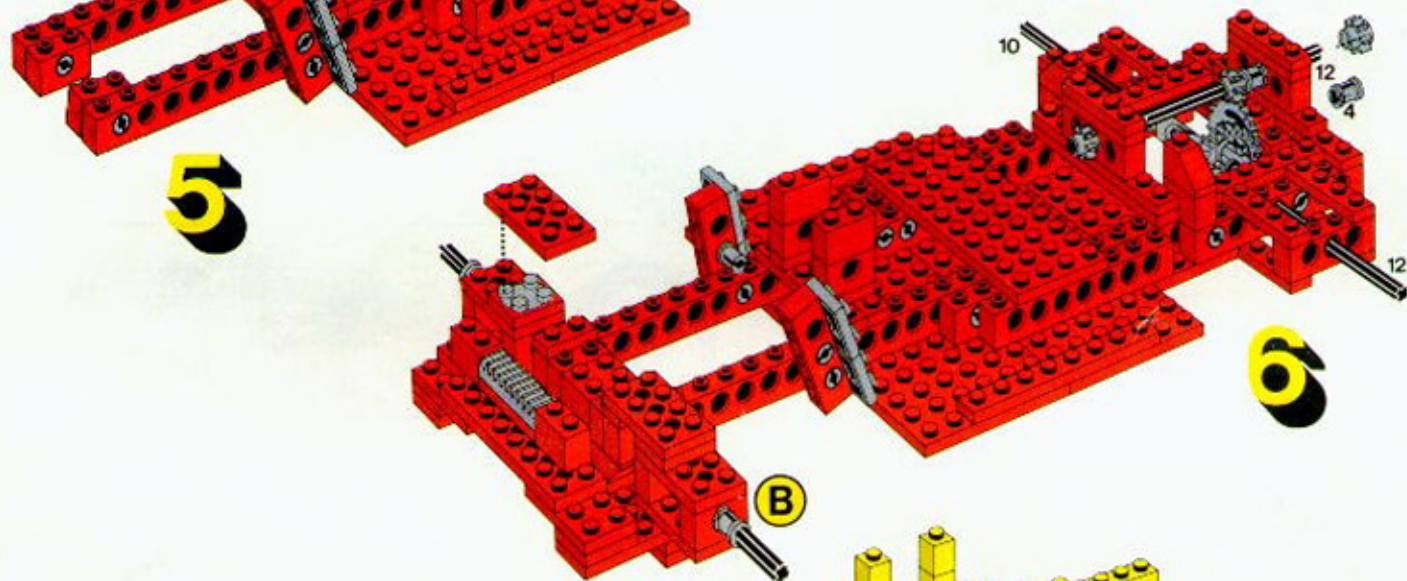
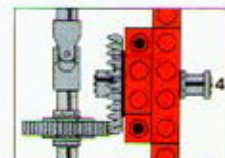

6

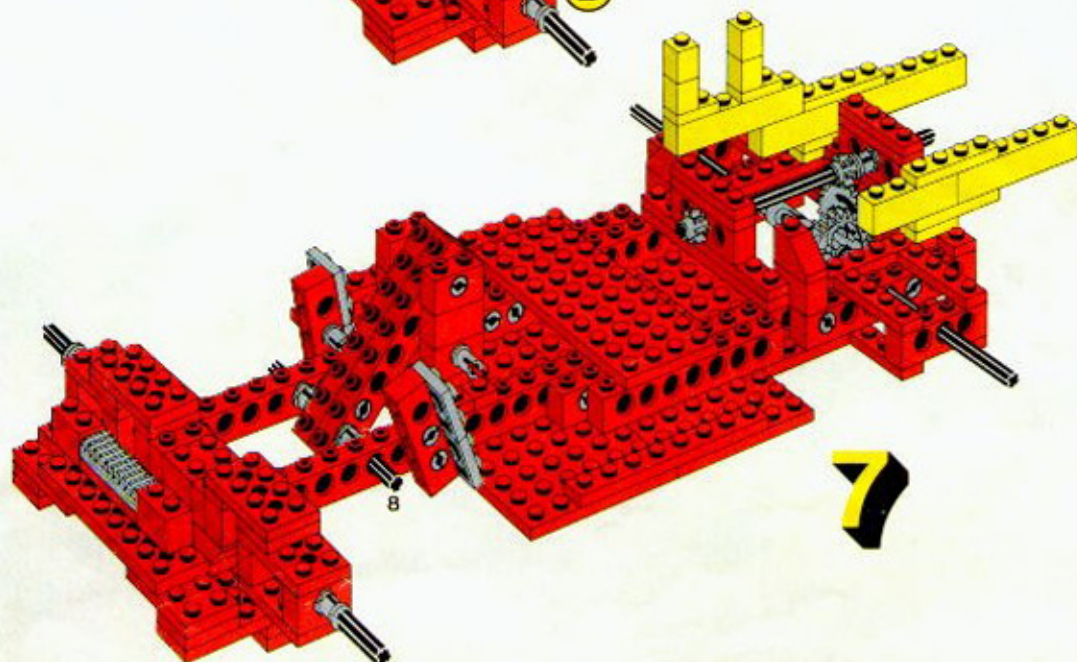

7



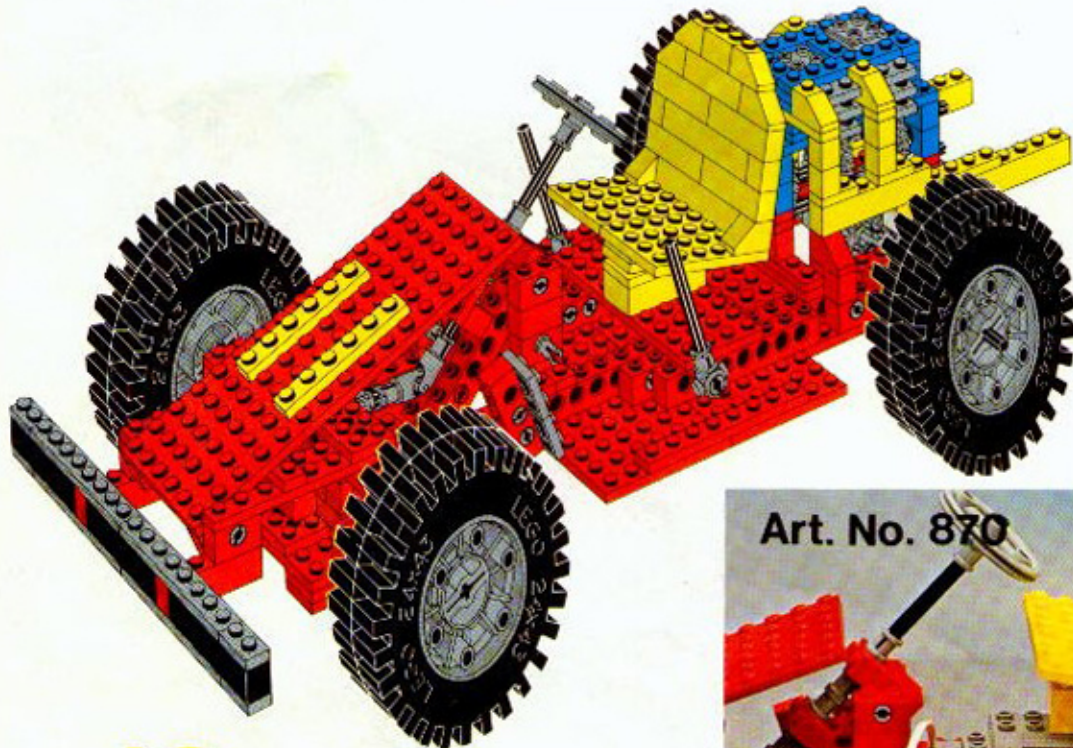
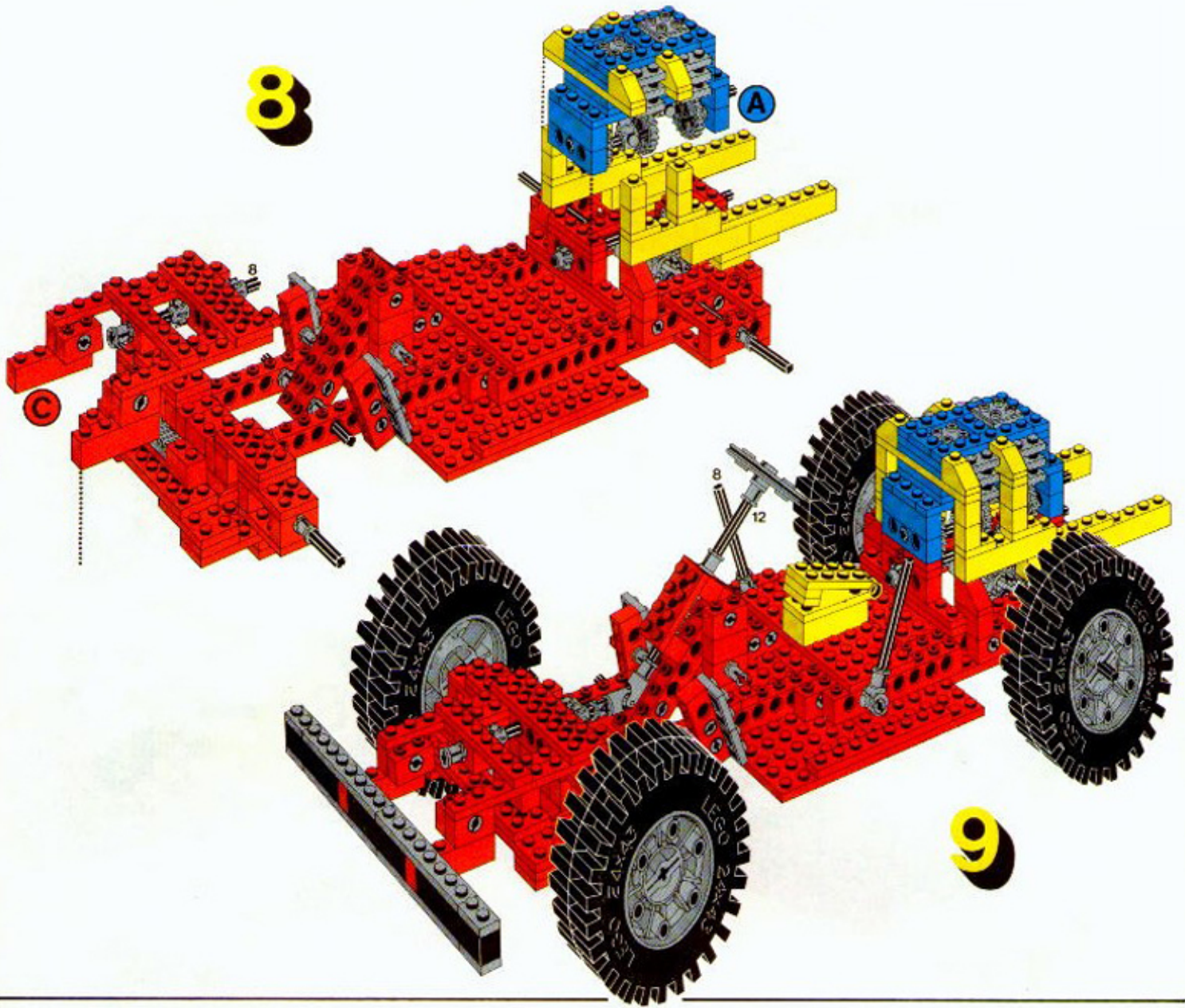



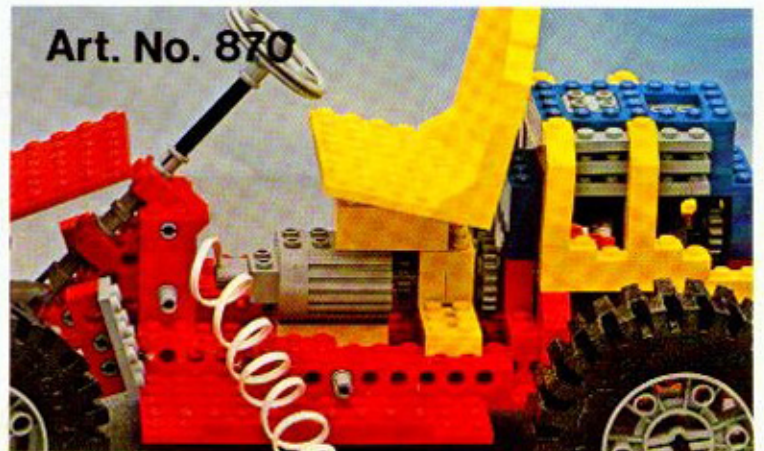



8

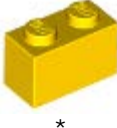

10

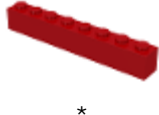

Art. No. 870

Image	Qty	Item No	Description	MID
Regular Items:				
Parts:				
+  *	18	3005	Yellow Brick 1 x 1 Catalog: Parts: Brick	PG
+  *	9	3004	Red Brick 1 x 2 Catalog: Parts: Brick	PG
+  *	2	3004	Yellow Brick 1 x 2 Catalog: Parts: Brick	PG
+  *	4	3010	Black Brick 1 x 4 Catalog: Parts: Brick	PG
+  *	6	3010	Blue Brick 1 x 4 Catalog: Parts: Brick	PG
+  *	6	3010	Red Brick 1 x 4 Catalog: Parts: Brick	PG
+  *	8	3010	Yellow Brick 1 x 4 Catalog: Parts: Brick	PG
+  *	4	3009	Black Brick 1 x 6 Catalog: Parts: Brick	PG
+  *	10	3009	Yellow Brick 1 x 6 Catalog: Parts: Brick	PG
+  *	2	3008	Black Brick 1 x 8 Catalog: Parts: Brick	PG
+  *	5	3008	Red Brick 1 x 8 Catalog: Parts: Brick	PG

+



*

4

[3003old](#)

Red Brick 2 x 2 without Inside Supports

[Catalog:](#) [Parts:](#) [Brick](#)

[PG](#)

1



+



*

2

[3001old](#)

Yellow Brick 2 x 4 without Cross Supports

[Catalog:](#) [Parts:](#) [Brick](#)

[PG](#)

+



*

4

[3149c01\(inv\)](#)

Yellow Hinge Plate 2 x 4

[Catalog:](#) [Parts:](#) [Hinge](#)

[PG](#)

+



*

2

[3024](#)

Blue Plate 1 x 1

[Catalog:](#) [Parts:](#) [Plate](#)

[PG](#)

+



*

6

[3024](#)

Yellow Plate 1 x 1

[Catalog:](#) [Parts:](#) [Plate](#)

[PG](#)

+



*

25

[3023](#)

Blue Plate 1 x 2

[Catalog:](#) [Parts:](#) [Plate](#)

[PG](#)

+



*

8

[3023](#)

Light Gray Plate 1 x 2

[Catalog:](#) [Parts:](#) [Plate](#)

[PG](#)

+



*

7

[3023](#)

Red Plate 1 x 2

[Catalog:](#) [Parts:](#) [Plate](#)

[PG](#)

+



*

17

[3023](#)

Yellow Plate 1 x 2

[Catalog:](#) [Parts:](#) [Plate](#)

[PG](#)

+



*

7

[3710](#)

Blue Plate 1 x 4

[Catalog:](#) [Parts:](#) [Plate](#)

[PG](#)

+



*

8

[3710](#)

Light Gray Plate 1 x 4

[Catalog:](#) [Parts:](#) [Plate](#)

[PG](#)

+



*

23

[3710](#)

Red Plate 1 x 4

[Catalog:](#) [Parts:](#) [Plate](#)

[PG](#)

+		5	3710	Yellow Plate 1 x 4 Catalog: Parts: Plate	PG
---	--	---	----------------------	--	--------------------

+		15	3666	Blue Plate 1 x 6 Catalog: Parts: Plate	PG
---	---	----	----------------------	--	--------------------

+		8	3666	Red Plate 1 x 6 Catalog: Parts: Plate	PG
---	---	---	----------------------	---	--------------------

+		2	3666	Yellow Plate 1 x 6 Catalog: Parts: Plate	PG
---	---	---	----------------------	--	--------------------

+		8	3460	Blue Plate 1 x 8 Catalog: Parts: Plate	PG
---	---	---	----------------------	--	--------------------



+		8	3460	Light Gray Plate 1 x 8 Catalog: Parts: Plate	PG
---	--	---	----------------------	--	--------------------

+		11	3460	Red Plate 1 x 8 Catalog: Parts: Plate	PG
---	---	----	----------------------	---	--------------------

+		2	3460	Yellow Plate 1 x 8 Catalog: Parts: Plate	PG
---	---	---	----------------------	--	--------------------

+		2	3022	Blue Plate 2 x 2 Catalog: Parts: Plate	PG
---	---	---	----------------------	--	--------------------

+		24	3022	Light Gray Plate 2 x 2 Catalog: Parts: Plate	PG
---	---	----	----------------------	--	--------------------

+		9	3022	Red Plate 2 x 2 Catalog: Parts: Plate	PG 1 
---	---	---	----------------------	---	--

+		2	3021	Blue Plate 2 x 3 Catalog: Parts: Plate	PG
---	---	---	----------------------	--	--------------------

+



*

3

[3021](#)

Red Plate 2 x 3

[Catalog:](#) [Parts:](#) [Plate](#)

[PG](#)

+



*

10

[3021](#)

Yellow Plate 2 x 3

[Catalog:](#) [Parts:](#) [Plate](#)

[PG](#)

+



*

2

[3020](#)

Blue Plate 2 x 4

[Catalog:](#) [Parts:](#) [Plate](#)

[PG](#)

+



*

3

[3020](#)

Red Plate 2 x 4

[Catalog:](#) [Parts:](#) [Plate](#)

[PG](#)

+



*

2

[3020](#)

Yellow Plate 2 x 4

[Catalog:](#) [Parts:](#) [Plate](#)

[PG](#)

+



*

2

[3034](#)

Red Plate 2 x 8

[Catalog:](#) [Parts:](#) [Plate](#)

[PG](#)

+

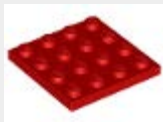

*

1

[3031](#)

Red Plate 4 x 4

[Catalog:](#) [Parts:](#) [Plate](#)

[PG](#)

+

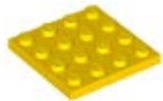

*

2

[3031](#)

Yellow Plate 4 x 4

[Catalog:](#) [Parts:](#) [Plate](#)

[PG](#)

+



*

2

[3032](#)

Red Plate 4 x 6

[Catalog:](#) [Parts:](#) [Plate](#)

[PG](#)

+



*

2

[3032](#)

Yellow Plate 4 x 6

[Catalog:](#) [Parts:](#) [Plate](#)

[PG](#)

+



*

2

[3030](#)

Red Plate 4 x 10

[Catalog:](#) [Parts:](#) [Plate](#)

[PG](#)

+



*









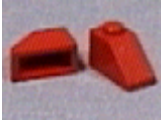

3

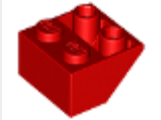







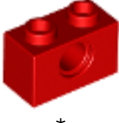

[3027](#)

Red Plate 6 x 16

[Catalog:](#) [Parts:](#) [Plate](#)

[PG](#)

+	 *	1	3027	Yellow Plate 6 x 16 Catalog: Parts: Plate	PG		
+	 *	5	3040a	Red Slope 45 2 x 1 - without Bottom Tube Catalog: Parts: Slope	PG		
+	 *	10	3040a	Yellow Slope 45 2 x 1 - without Bottom Tube Catalog: Parts: Slope	PG		
+	 *	2	3039	Red Slope 45 2 x 2 Catalog: Parts: Slope	PG	1	■
+	 *	11	3660	Red Slope, Inverted 45 2 x 2 Catalog: Parts: Slope, Inverted	PG		
+	 *	16	3713	Light Gray Technic Bush Catalog: Parts: Technic	PG	1	■
+	 *	4	3652	Light Gray Technic Engine Piston Square 2 x 2 - Old Catalog: Parts: Technic	PG		
+	 *	9	3704	Black Technic, Axle 2 Catalog: Parts: Technic, Axle	PG	1	■
+	 *	12	3705	Black Technic, Axle 4 Catalog: Parts: Technic, Axle	PG	1	■
+	 *	1	3706	Black Technic, Axle 6 Catalog: Parts: Technic, Axle	PG		
+	 *	6	3707	Black Technic, Axle 8 Catalog: Parts: Technic, Axle	PG		
+	 *	2	3737	Black Technic, Axle 10 Catalog: Parts: Technic, Axle	PG		

+		3	3708	Black Technic, Axle 12 Catalog: Parts: Technic, Axle	PG
	*				
+		17	3651	Light Gray Technic, Axle and Pin Connector Catalog: Parts: Technic, Connector	PG
	*				
+		1	3700	Blue Technic, Brick 1 x 2 with Hole Catalog: Parts: Technic, Brick	PG
	*				
+		22	3700	Red Technic, Brick 1 x 2 with Hole Catalog: Parts: Technic, Brick	PG
	*				
+		2	3700	Yellow Technic, Brick 1 x 2 with Hole Catalog: Parts: Technic, Brick	PG
	*				
+		4	3701	Blue Technic, Brick 1 x 4 with Holes Catalog: Parts: Technic, Brick	PG
	*				
+		11	3701	Red Technic, Brick 1 x 4 with Holes Catalog: Parts: Technic, Brick	PG
	*				
+		2	3701	Yellow Technic, Brick 1 x 4 with Holes Catalog: Parts: Technic, Brick	PG
	*				
+		1	3702	Blue Technic, Brick 1 x 8 with Holes Catalog: Parts: Technic, Brick	PG
	*				
+		8	3702	Red Technic, Brick 1 x 8 with Holes Catalog: Parts: Technic, Brick	PG
	*				
+		10	3703	Red Technic, Brick 1 x 16 with Holes Catalog: Parts: Technic, Brick	PG
	*				
+		9	3647	Light Gray Technic, Gear 8 Tooth Type 1 Catalog: Parts: Technic, Gear	PG
	*				

+		12	x187	Light Gray Technic, Gear 24 Tooth (1st Version - 3 Axle Holes) Catalog: Parts: Technic, Gear	PG		
+		1	3650a	Light Gray Technic, Gear 24 Tooth Crown (1st Version - Not Reinforced) Catalog: Parts: Technic, Gear	PG	2	
+		1	3649	Light Gray Technic, Gear 40 Tooth Catalog: Parts: Technic, Gear	PG		
+		3	3743	Light Gray Technic, Gear Rack 1 x 4 Catalog: Parts: Technic, Gear	PG		
+		42	3673	Light Gray Technic, Pin without Friction Ridges Lengthwise Catalog: Parts: Technic, Pin	PG	1	
+		1	3709b	Blue Technic, Plate 2 x 4 with 3 Holes Catalog: Parts: Technic, Plate	PG		
+		12	3709b	Red Technic, Plate 2 x 4 with 3 Holes Catalog: Parts: Technic, Plate	PG		
+		2	3738	Red Technic, Plate 2 x 8 with 7 Holes Catalog: Parts: Technic, Plate	PG		
+		1	3736	Light Gray Technic, Steering Pulley Large Catalog: Parts: Technic, Steering	PG		
+		5	9244c01 (inv)	Light Gray Technic, Universal Joint 4L Catalog: Parts: Technic, Connector	PG		
+		4	3069b	Yellow Tile 1 x 2 with Groove Catalog: Parts: Tile	PG		
+		18	3068b	Red Tile 2 x 2 with Groove Catalog: Parts: Tile	PG		

+	 *	4	3740	Black Tire 24 x 43 Technic Catalog: Parts: Tire & Tread	PG
---	---	---	----------------------	---	--------------------

+	 *	6	3680c01 (inv)	Red Turntable 2 x 2 Plate, Base with Light Gray Turntable 2 x 2 Plate, Top (3680 / 3679) Catalog: Parts: Turntable	PG
---	--	---	-------------------------------	--	--------------------

+	 *	4	3739	Light Gray Wheel 24 x 43 Technic Catalog: Parts: Wheel	PG
---	--	---	----------------------	--	--------------------

Extra Items:

+	 *	1	3024	Blue Plate 1 x 1 Catalog: Parts: Plate	PG
---	--	---	----------------------	--	--------------------

+	 *	1	3023	Blue Plate 1 x 2 Catalog: Parts: Plate	PG
---	--	---	----------------------	--	--------------------

+	 *	1	3023	Light Gray Plate 1 x 2 Catalog: Parts: Plate	PG
---	---	---	----------------------	--	--------------------

+	 *	1	3023	Red Plate 1 x 2 Catalog: Parts: Plate	PG
---	--	---	----------------------	---	--------------------

+	 *	1	3023	Yellow Plate 1 x 2 Catalog: Parts: Plate	PG
---	--	---	----------------------	--	--------------------

+	 *	3	3713	Light Gray Technic Bush Catalog: Parts: Technic	PG
---	--	---	----------------------	---	--------------------

+	 *	1	3704	Black Technic, Axle 2 Catalog: Parts: Technic, Axle	PG
---	--	---	----------------------	---	--------------------

+	 *	2	3705	Black Technic, Axle 4 Catalog: Parts: Technic, Axle	PG
---	--	---	----------------------	---	--------------------

+		2	3651	Light Gray Technic, Axle and Pin Connector Catalog: Parts: Technic, Connector	PG
---	--	---	----------------------	---	--------------------



+		1	3743	Light Gray Technic, Gear Rack 1 x 4 Catalog: Parts: Technic, Gear	PG
---	---	---	----------------------	---	--------------------



+		1	3673	Light Gray Technic, Pin without Friction Ridges Lengthwise Catalog: Parts: Technic, Pin	PG
---	---	---	----------------------	---	--------------------

+		1	3069b	Yellow Tile 1 x 2 with Groove Catalog: Parts: Tile	PG
---	---	---	-----------------------	--	--------------------



Counterparts:

+		4	3739c01(inv)	Light Gray Wheel 24 x 43 Technic with Black Tire 24 x 43 Technic (3739 / 3740) Catalog: Parts: Wheel & Tire Assembly	PG
---	---	---	------------------------------	--	--------------------



Alternate Items:



+		2	3003old	Red Brick 2 x 2 without Inside Supports Catalog: Parts: Brick	PG 1 
---	--	---	-------------------------	---	--

+		7	3022	Red Plate 2 x 2 Catalog: Parts: Plate	PG 1 
---	---	---	----------------------	---	--

+		18	3713	Light Gray Technic Bush Catalog: Parts: Technic	PG 1 
---	---	----	----------------------	---	--

+		7	3704	Black Technic, Axle 2 Catalog: Parts: Technic, Axle	PG 1 
---	---	---	----------------------	---	--

+		14	3705	Black Technic, Axle 4 Catalog: Parts: Technic, Axle	PG 1 
---	---	----	----------------------	---	--

+		1	3650a	Black Technic, Gear 24 Tooth Crown (1st Version - Not Reinforced) Catalog: Parts: Technic, Gear	PG 2 
---	---	---	-----------------------	---	--

+



41

[3673](#)

Light Gray Technic, Pin without Friction Ridges Lengthwise

[Catalog: Parts: Technic: Pin](#)

[PG](#)

1

*

Note:

Redesigned during production.

There are at least 2 different versions of instructions for this set. The differences for the second version are indicated in this inventory in the Alternate Items section with Match ID 99.

Quick overview of redesign: Reinforcements were made to the steering system. Several seemingly unnecessary plates with holes are retained from pre-production versions of the steering system.

Summary:

Type	Unique Lots	Total Qty
Regular Items:		
Parts	86	602
Extra Items:		
Parts	12	16
Counterparts:		
Parts	1	4
Alternative Items:		
Parts	7	90

[ctw_3 \(204\)](#)  inventoried this Set on Dec 3, 2003, inventory last updated on Apr 27, 2018.