

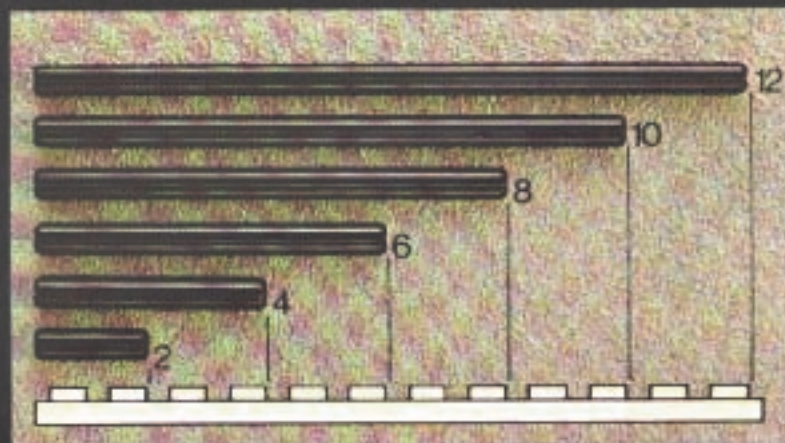

120066



In der Bauanleitung steht vor den Achsen eine Zahl, die die benötigte Länge der Achsen anzeigt.

Numbers in the building instructions near axles show the length of axle to be used.

Dans les conseils de construction, il y a un chiffre à côté de chaque axe. Ce chiffre indique la longueur des axes à utiliser.

Ut for akslerne i byggeanvisningen er anført et tal som viser hvilken aksellengde som skal brukes.

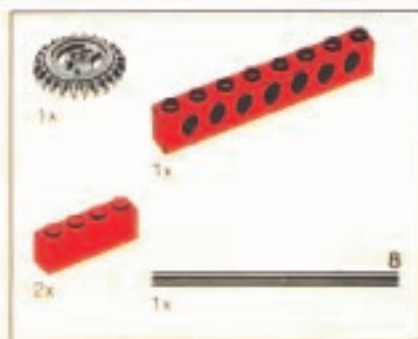

2

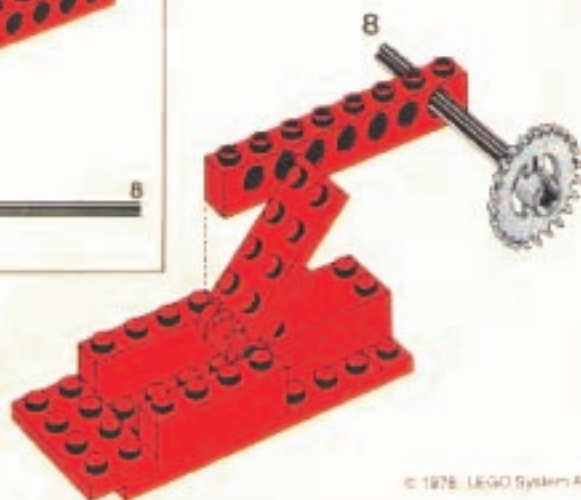

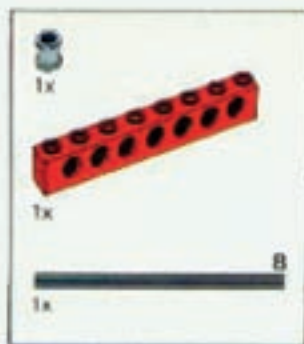

3

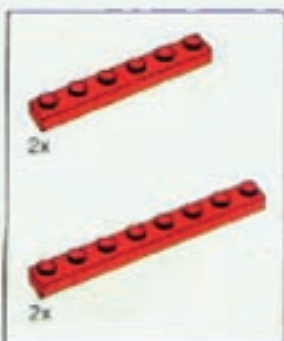
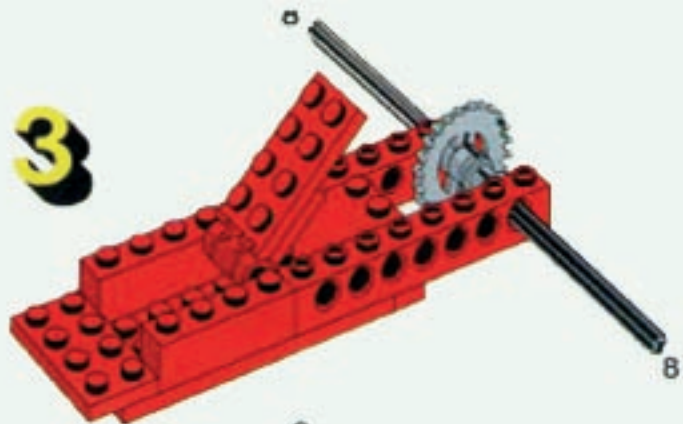

4

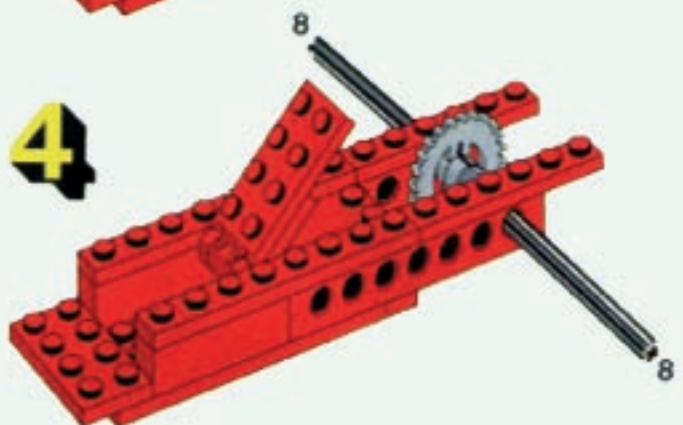

5

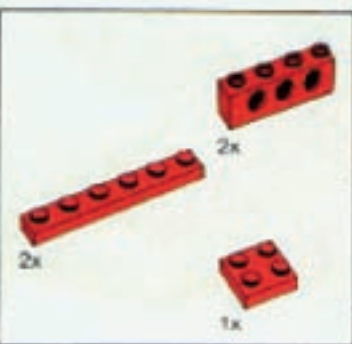
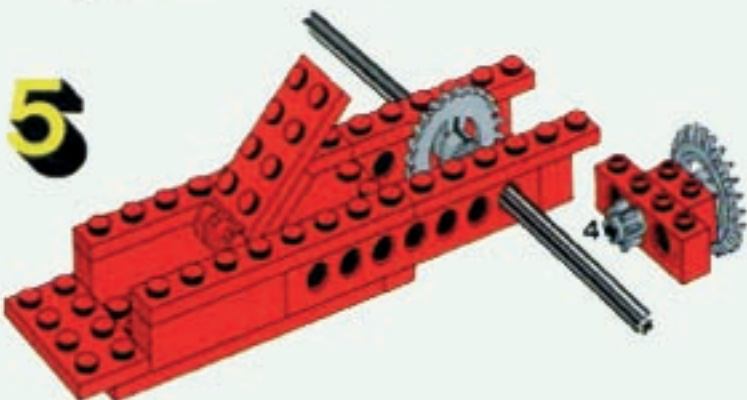

6

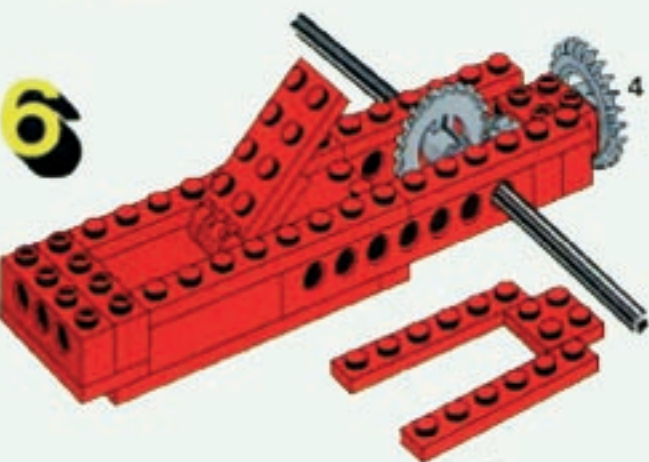

7

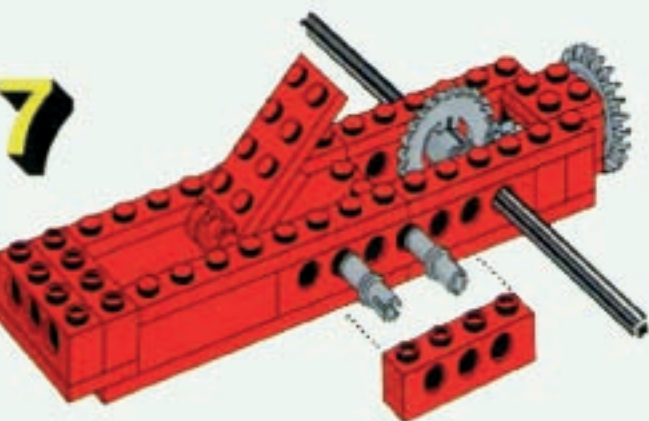



8

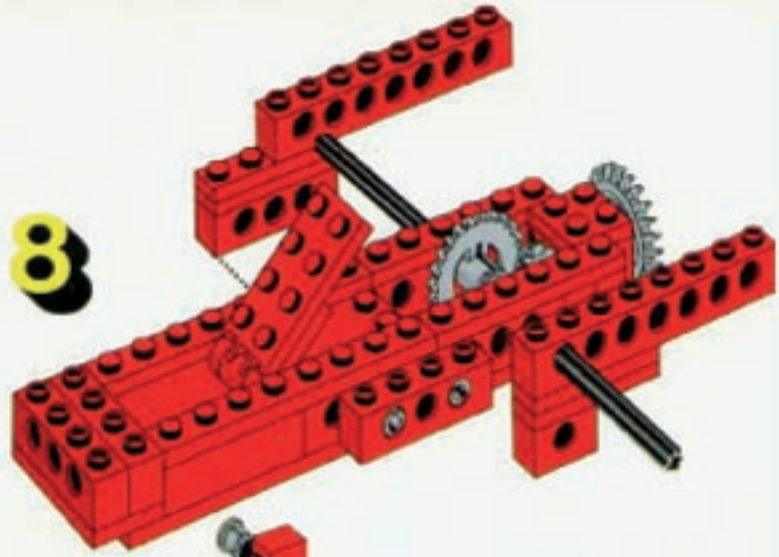

9

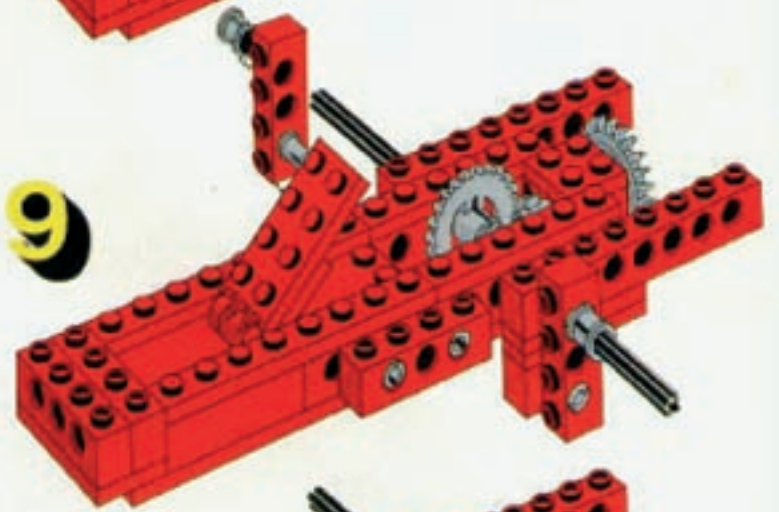

10

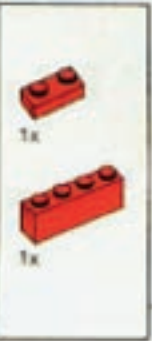
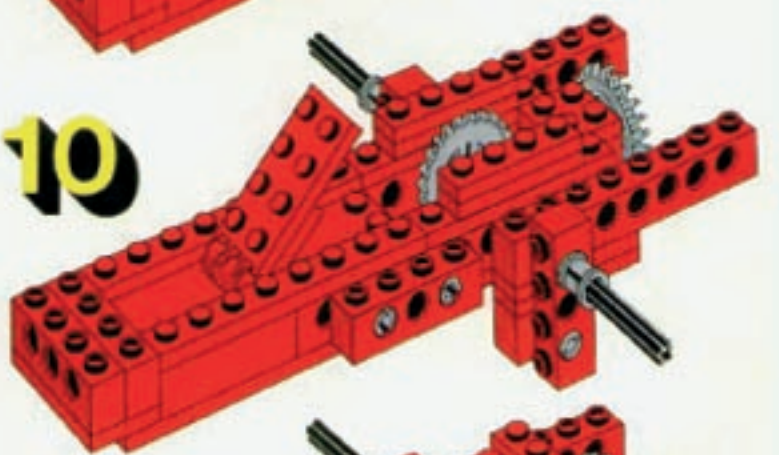

11

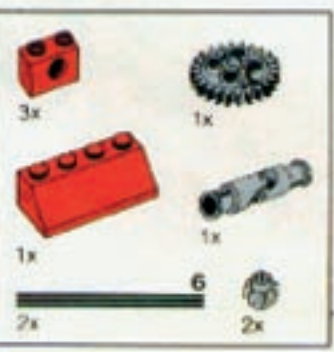
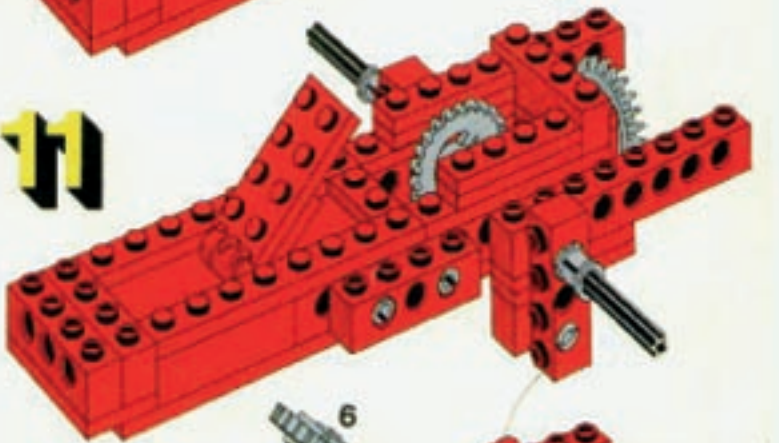

12

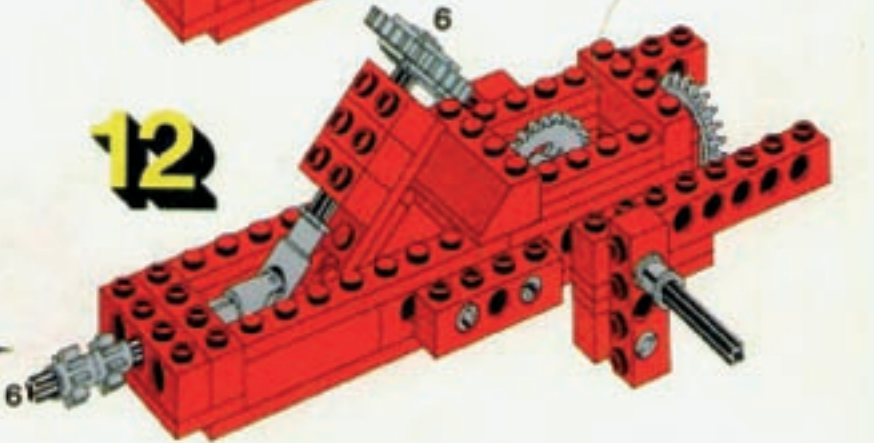

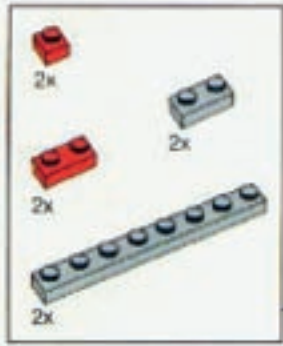

13

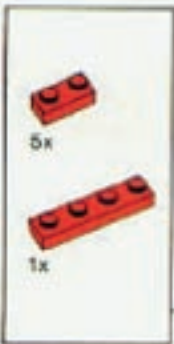
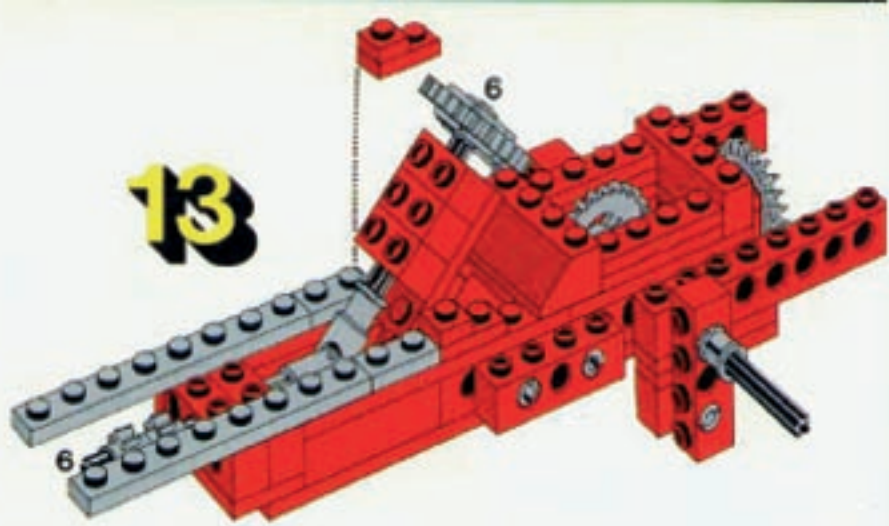

14

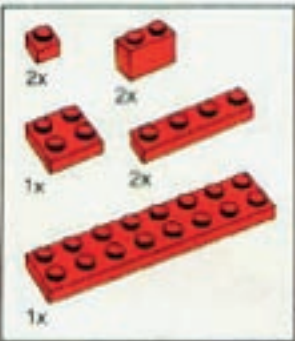
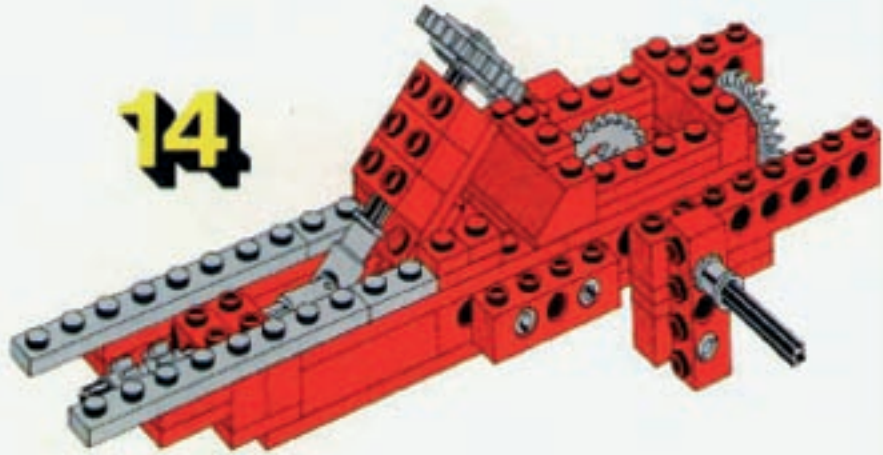

15

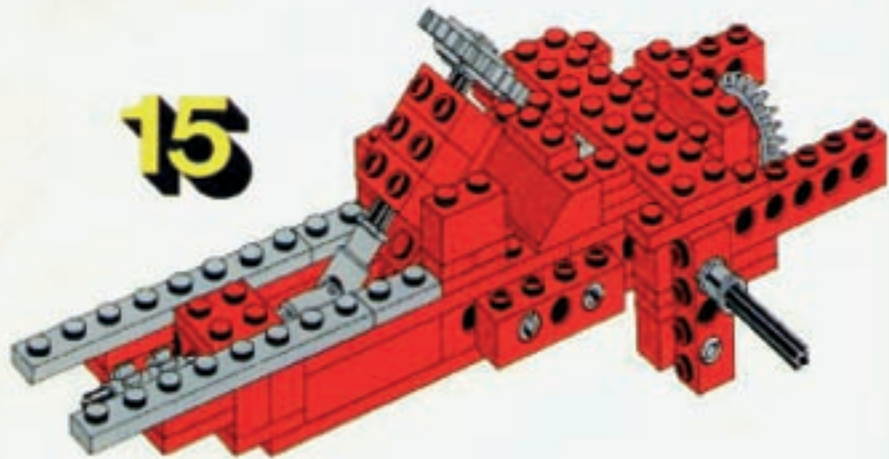

16

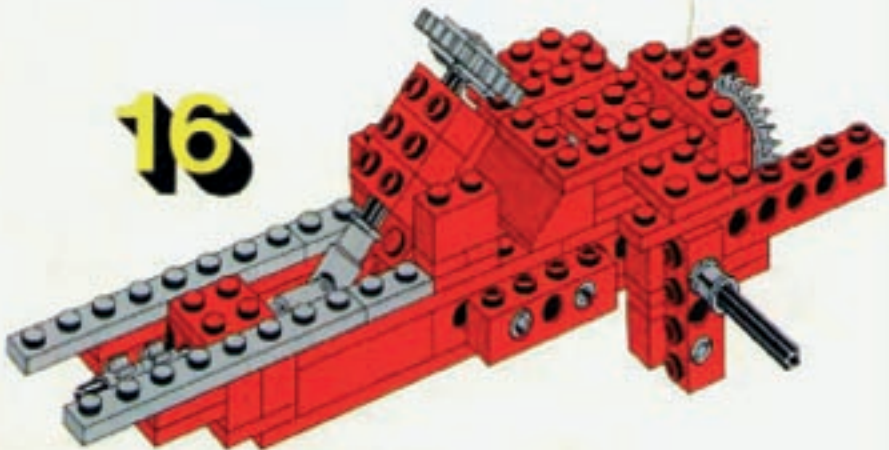



17

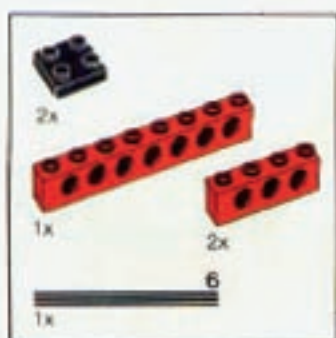
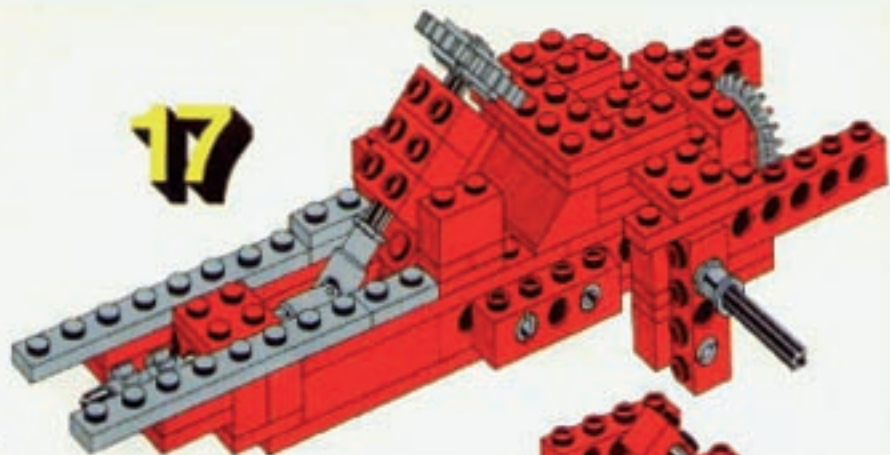

18



19

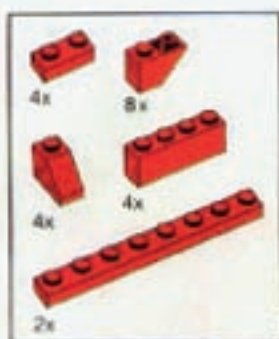
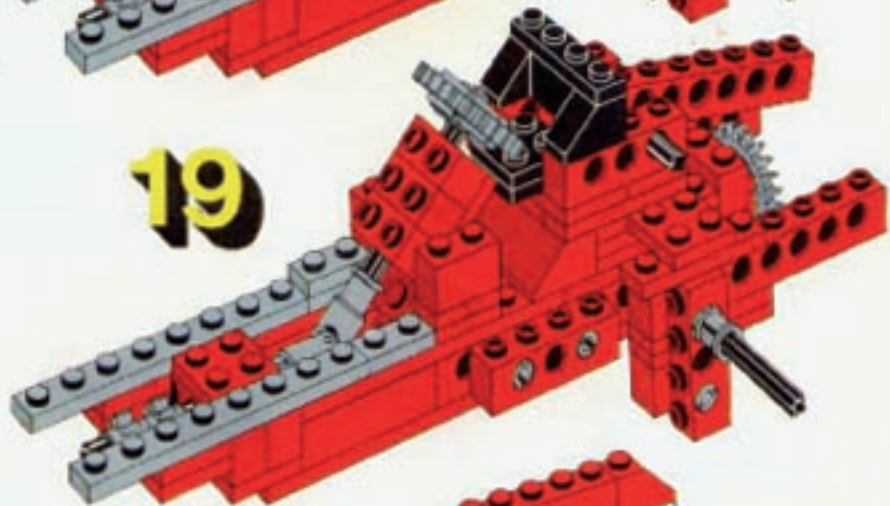

20



5

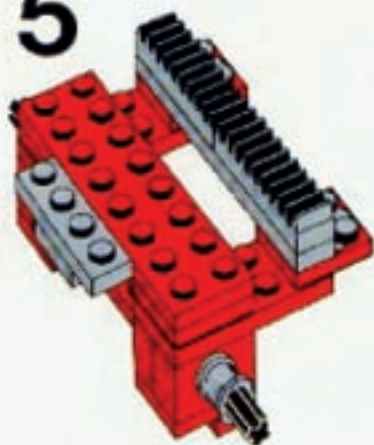

6

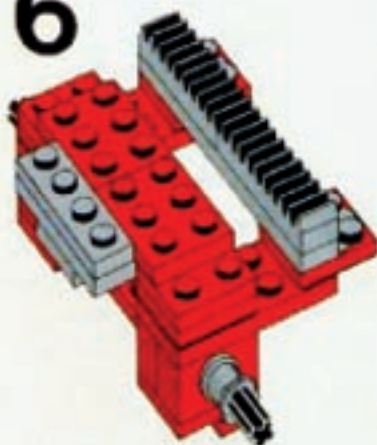

7

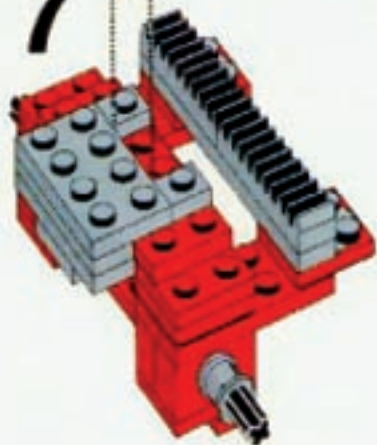

8

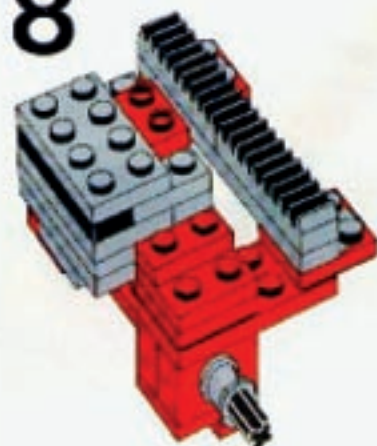

9



10

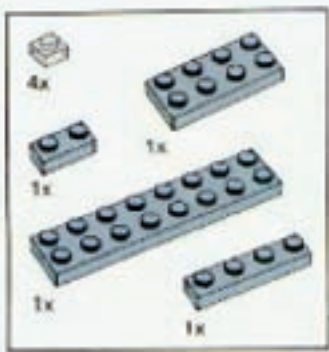
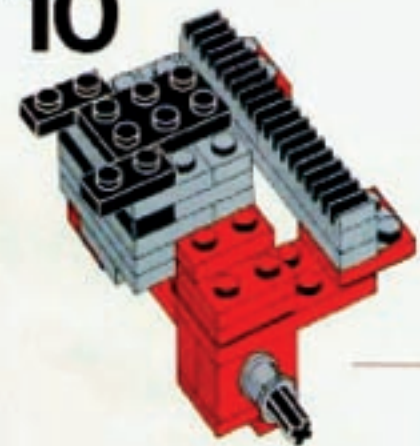

23

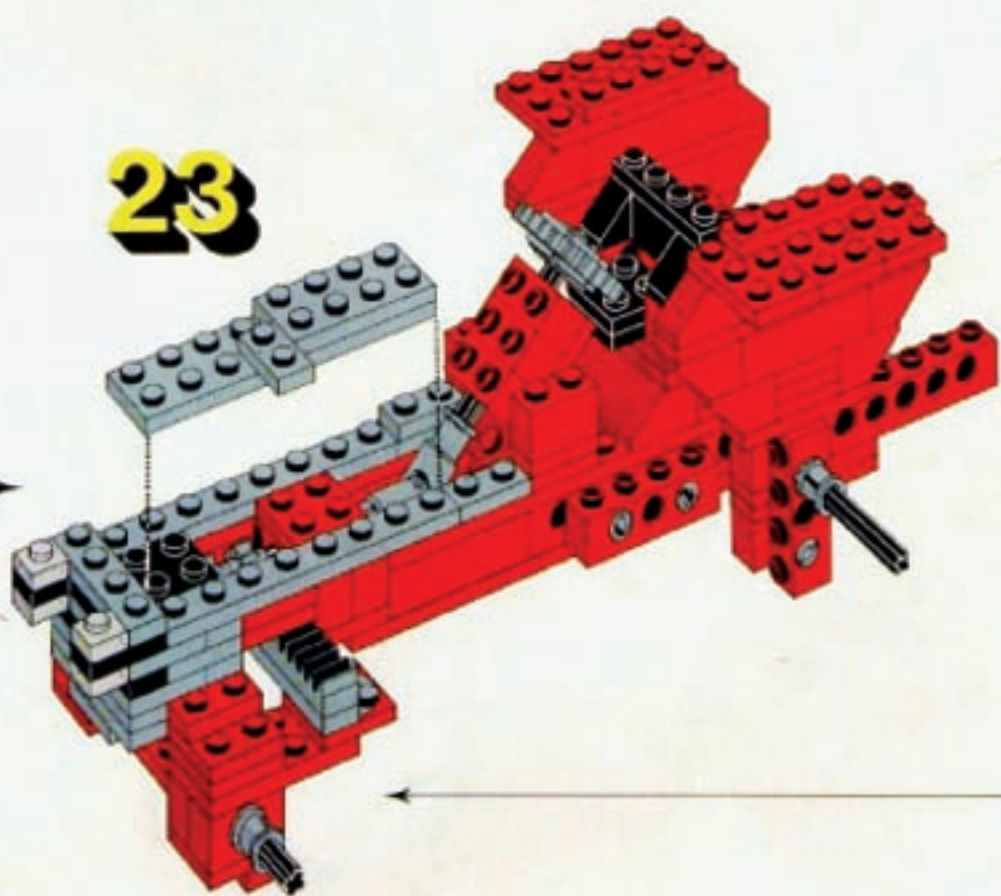



24

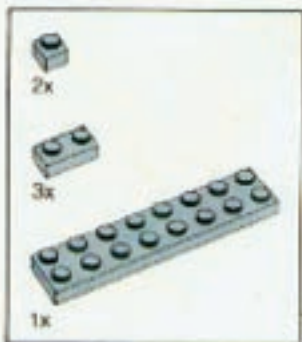

25

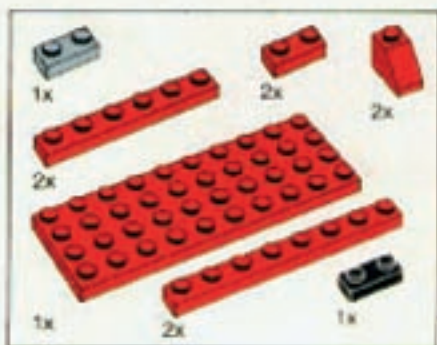

26

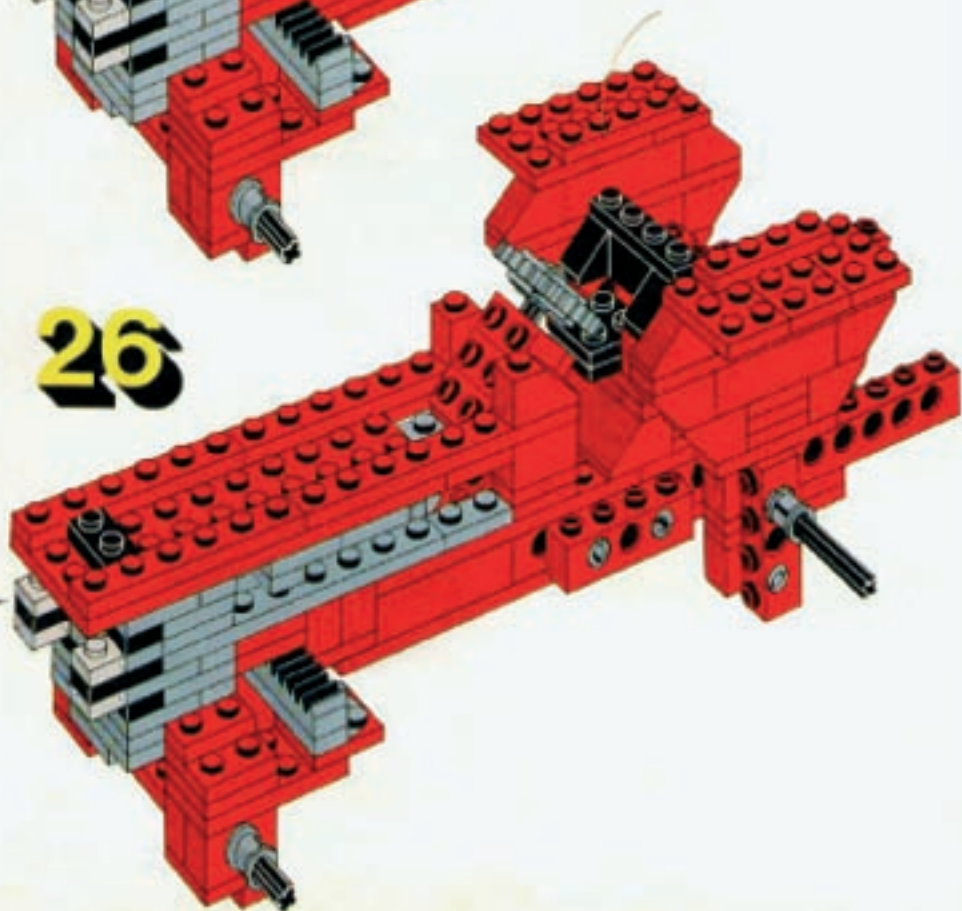

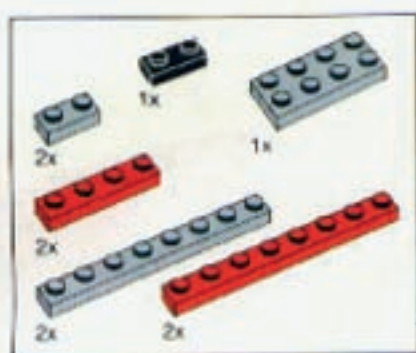

27

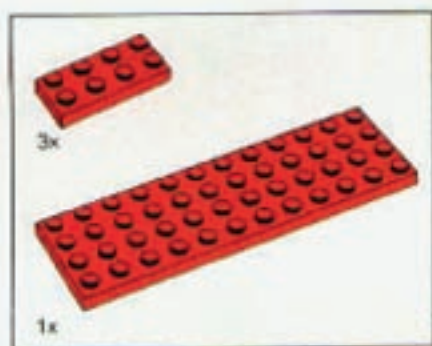
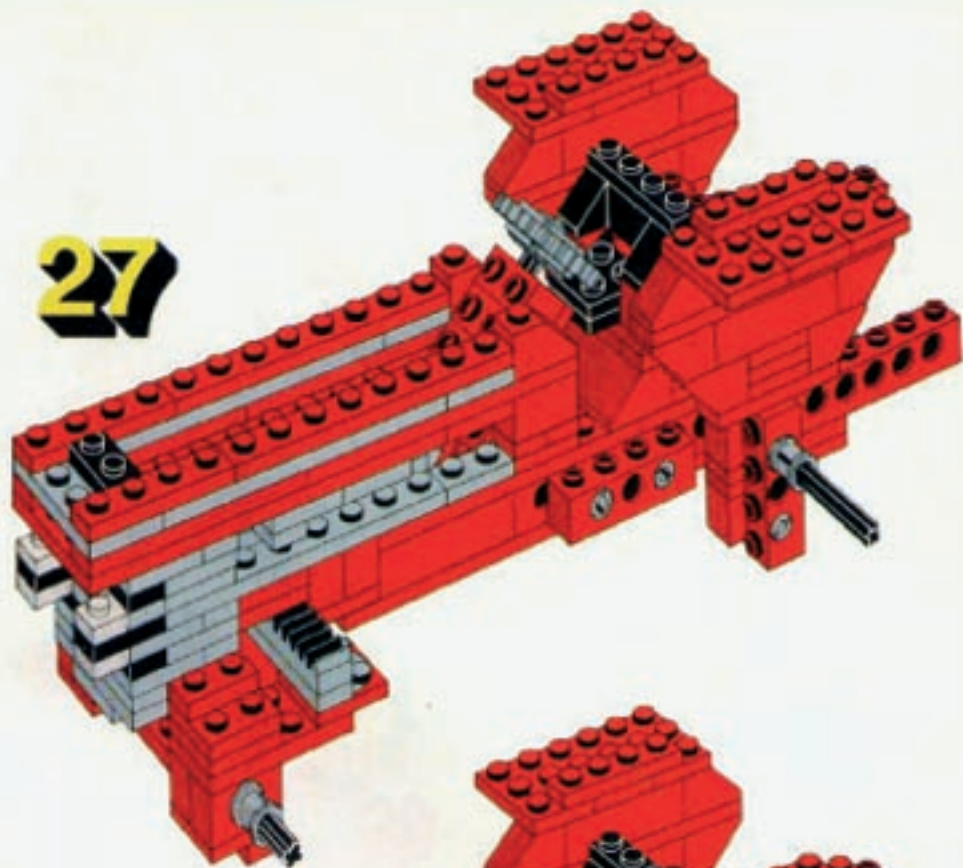

28

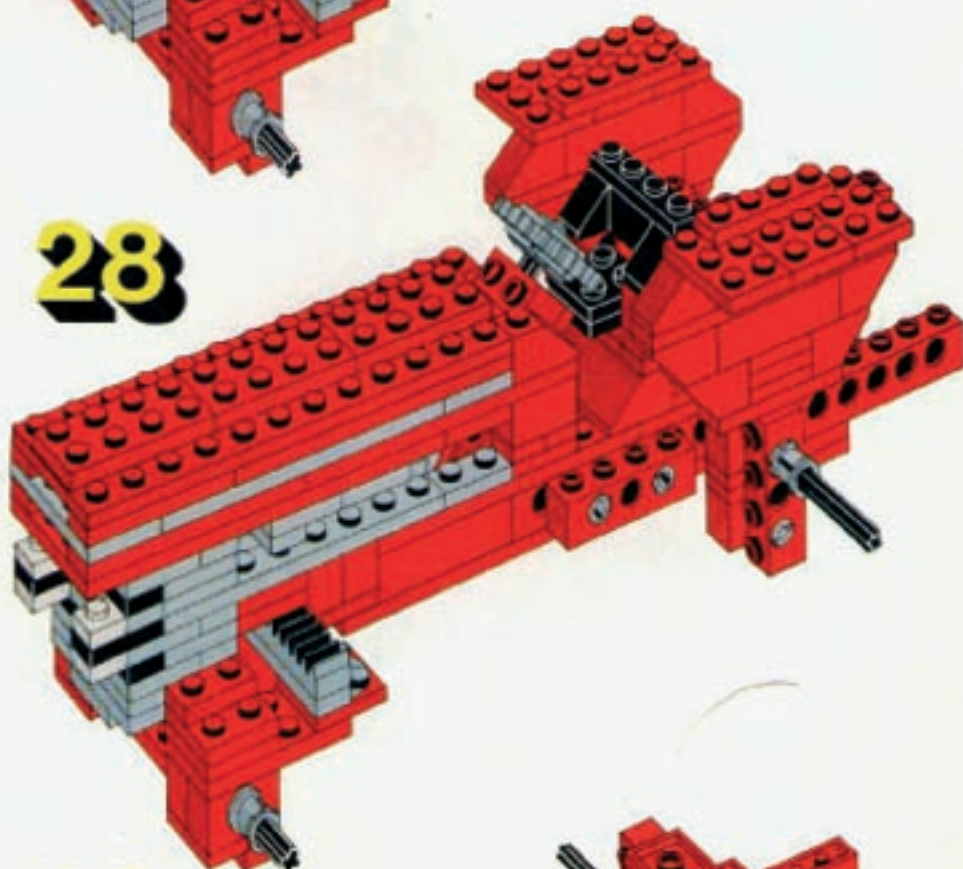

29

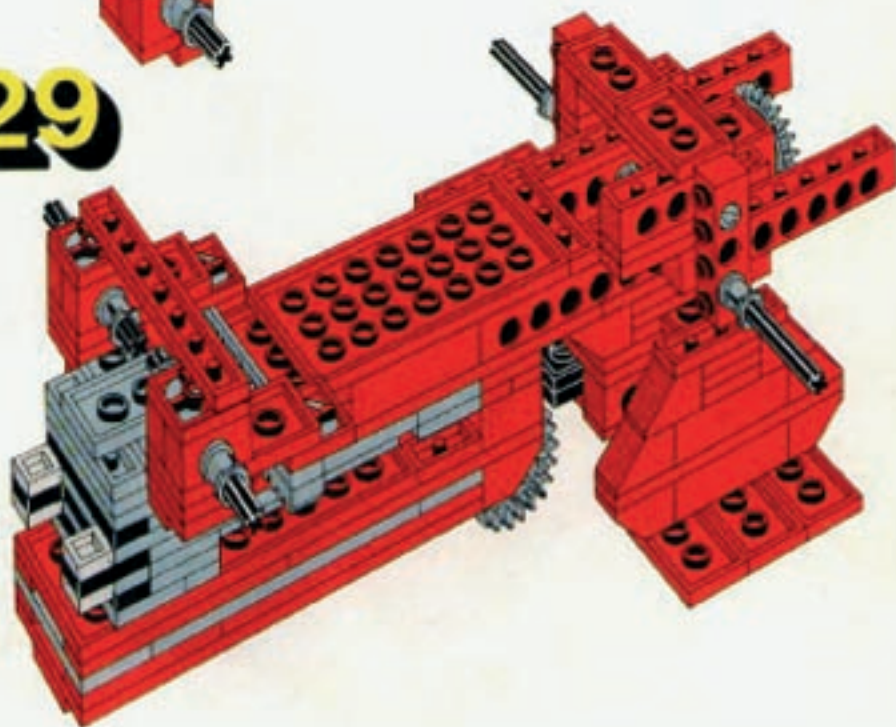

30

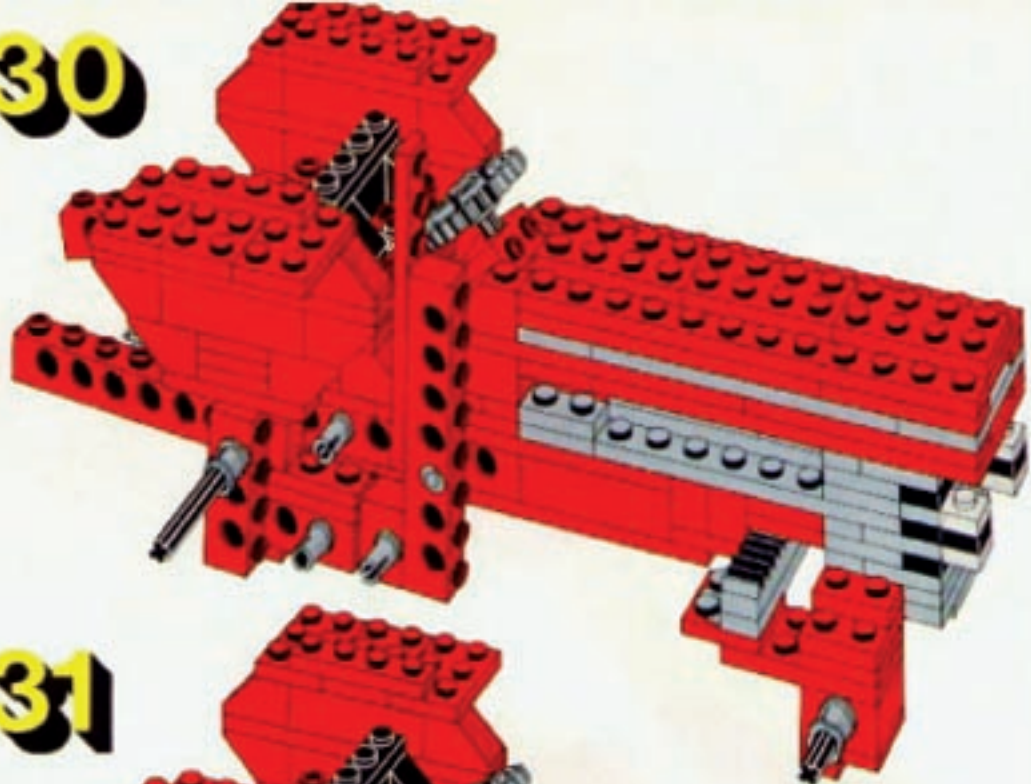

31

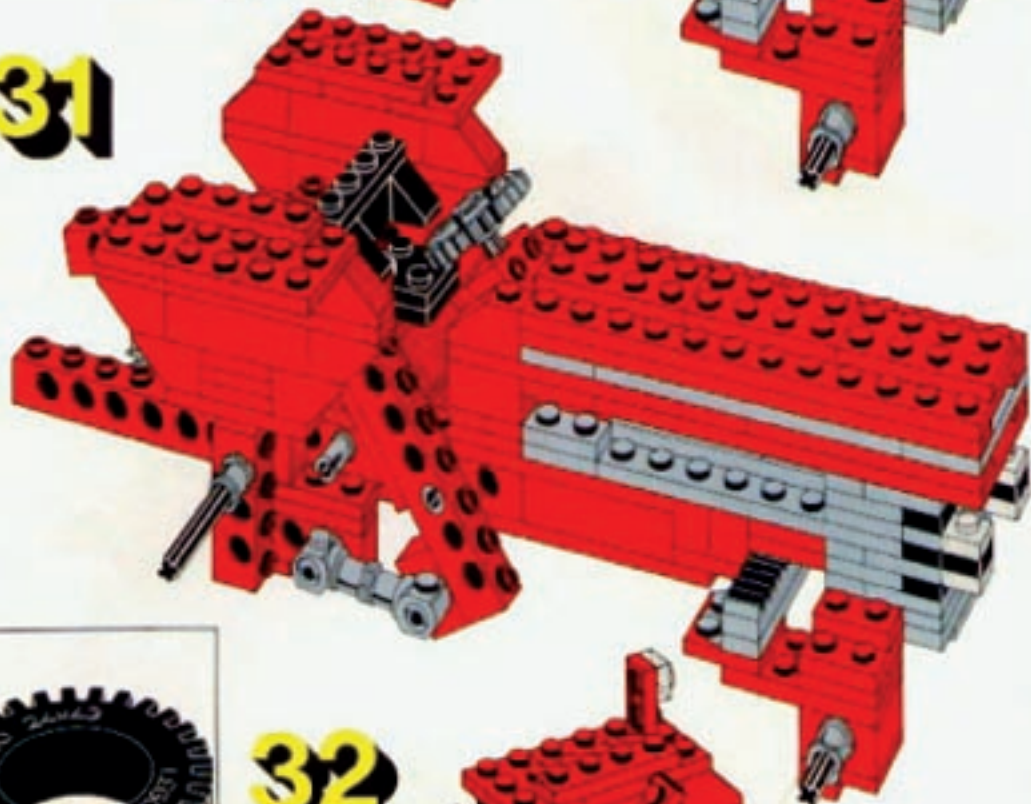

32

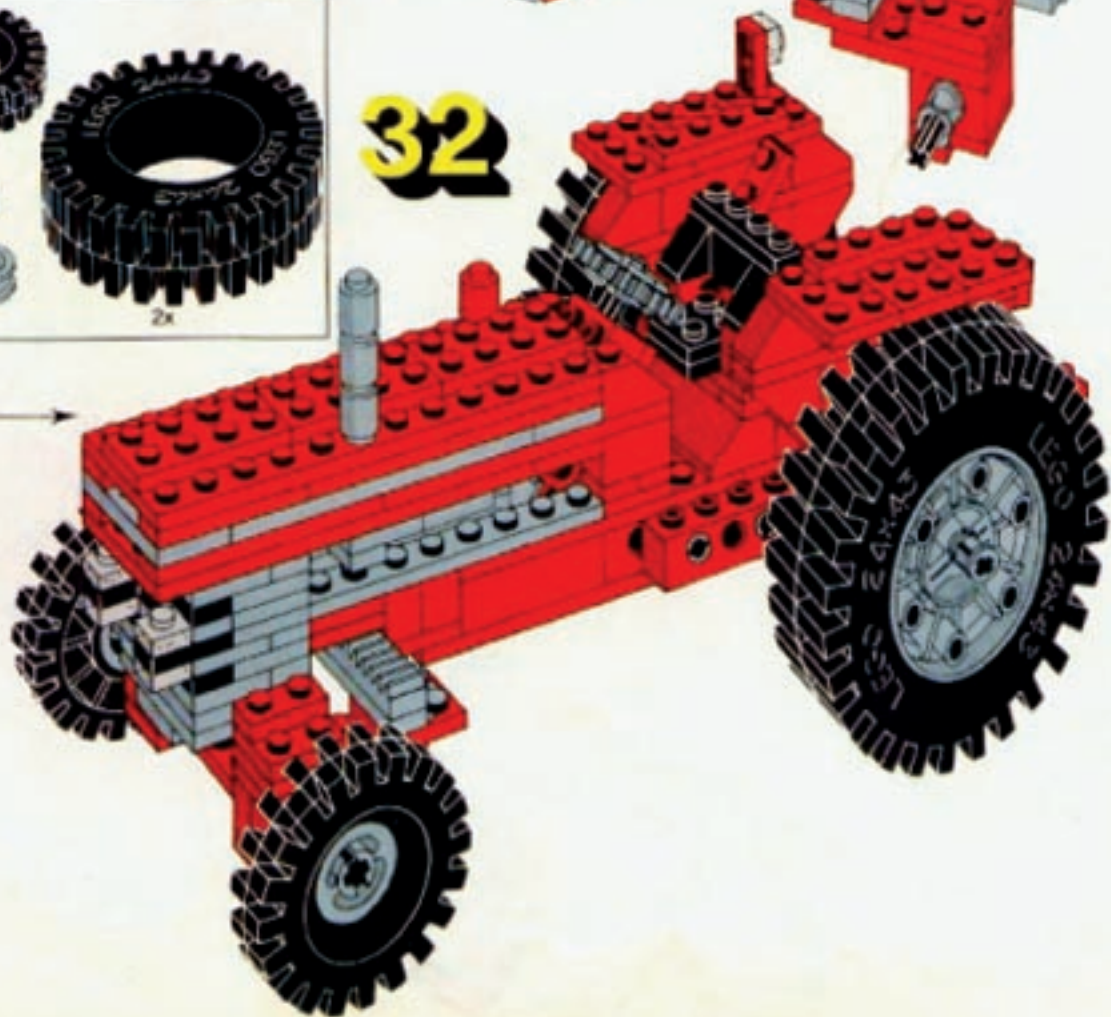
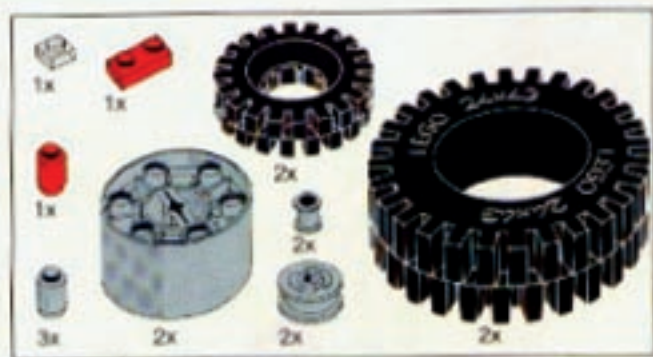



33

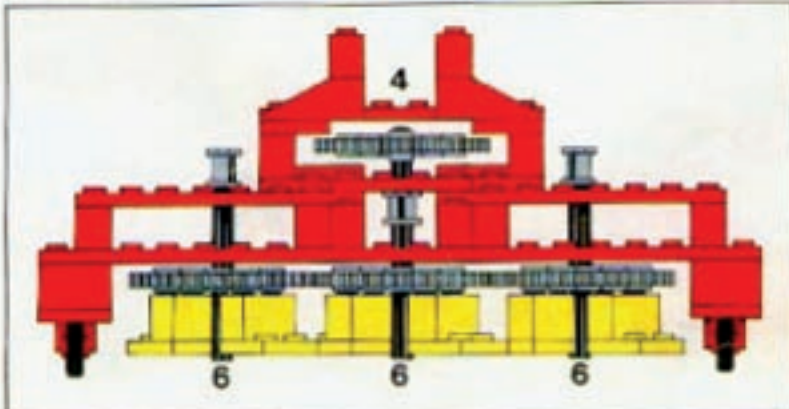
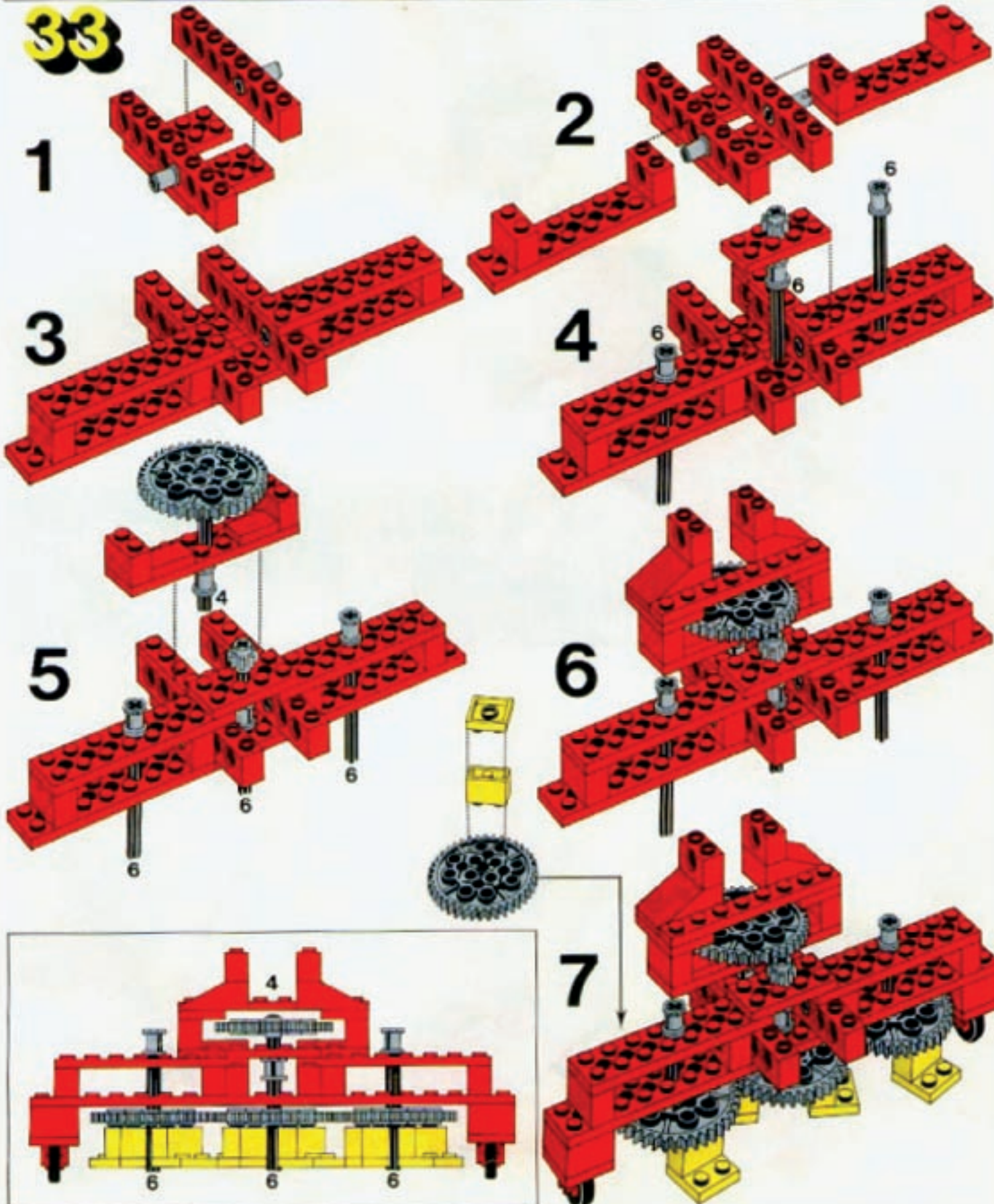

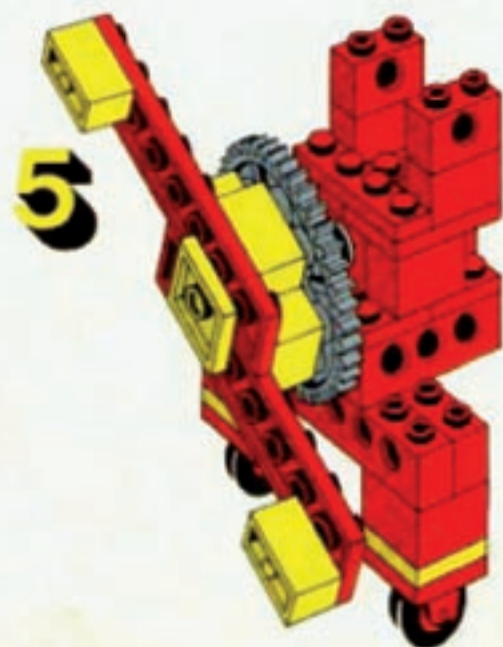
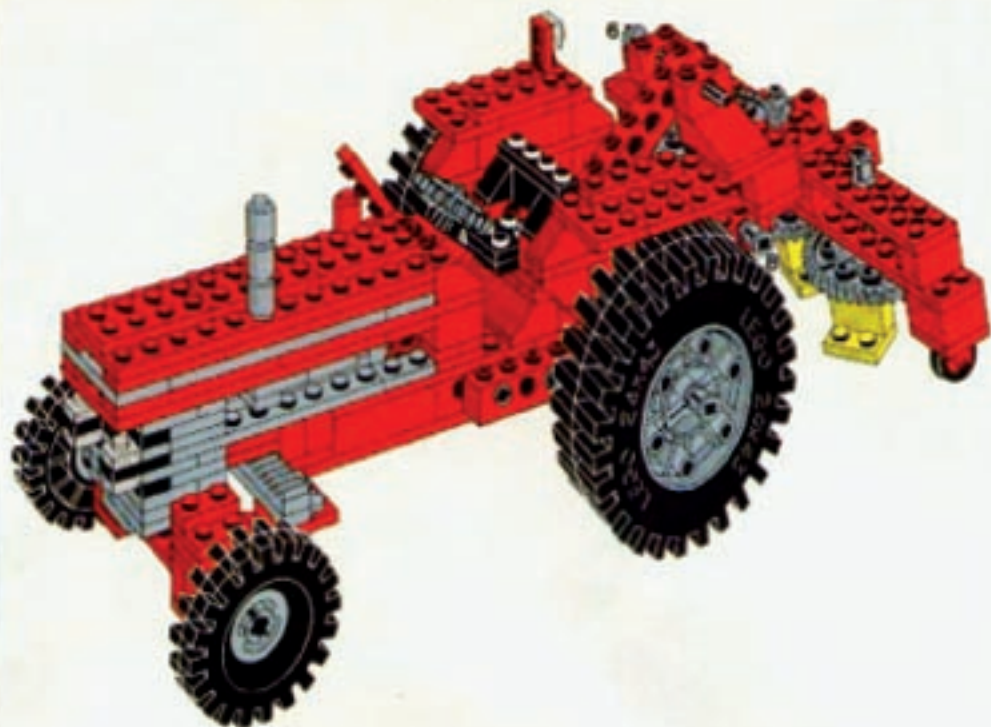
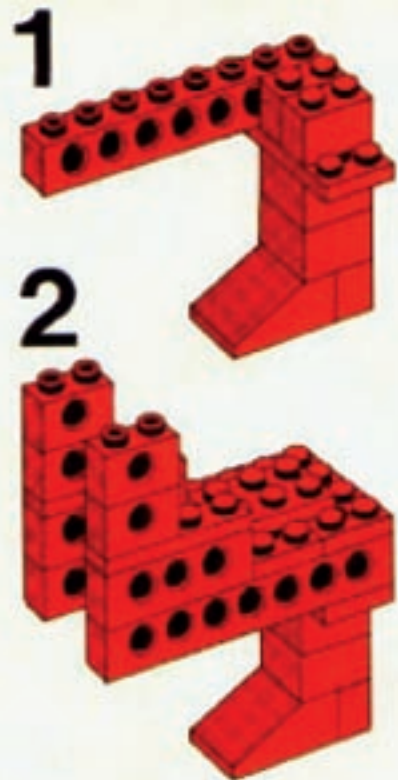

3

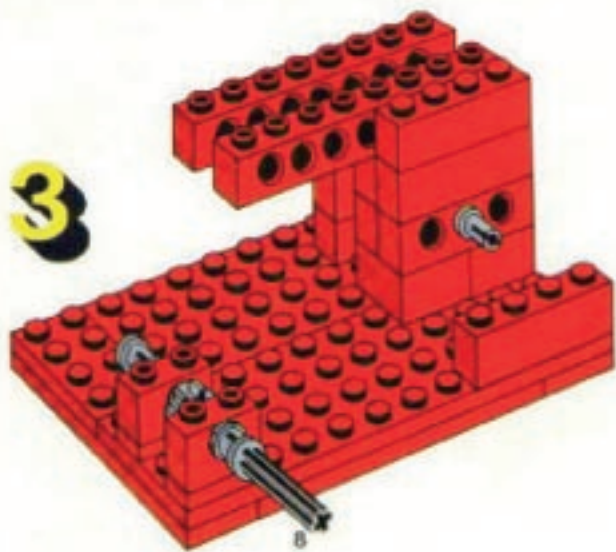

4

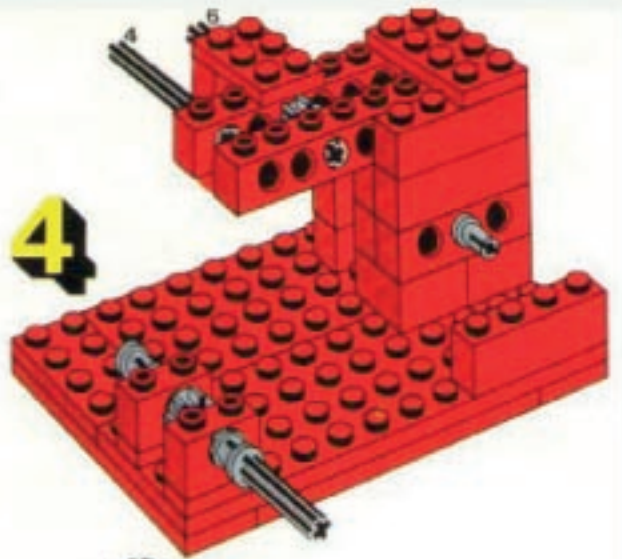

5

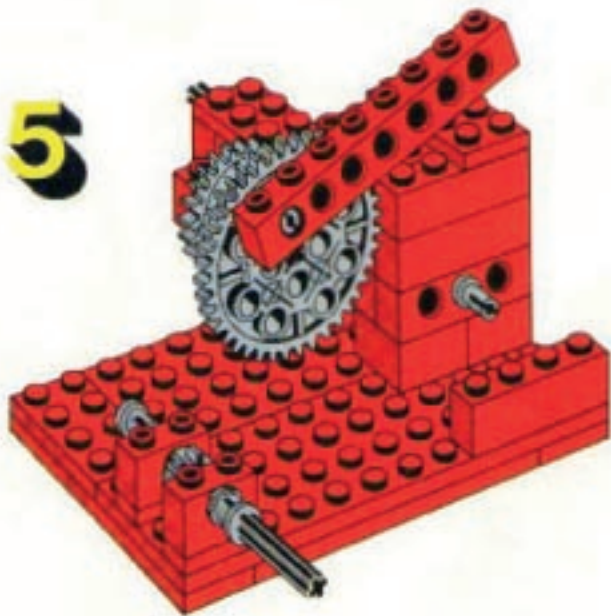

6

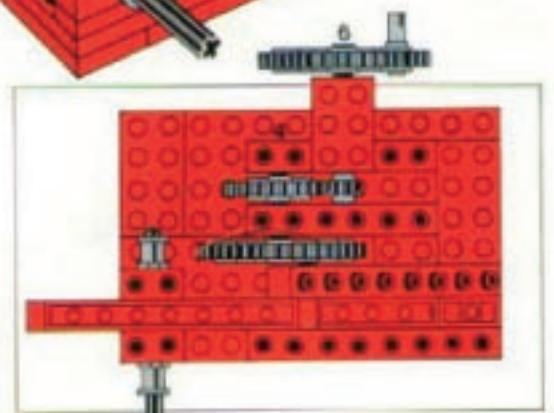
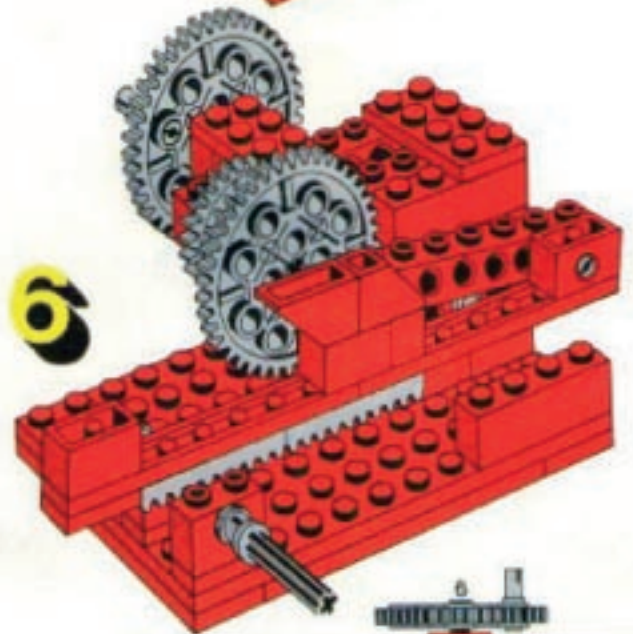

7

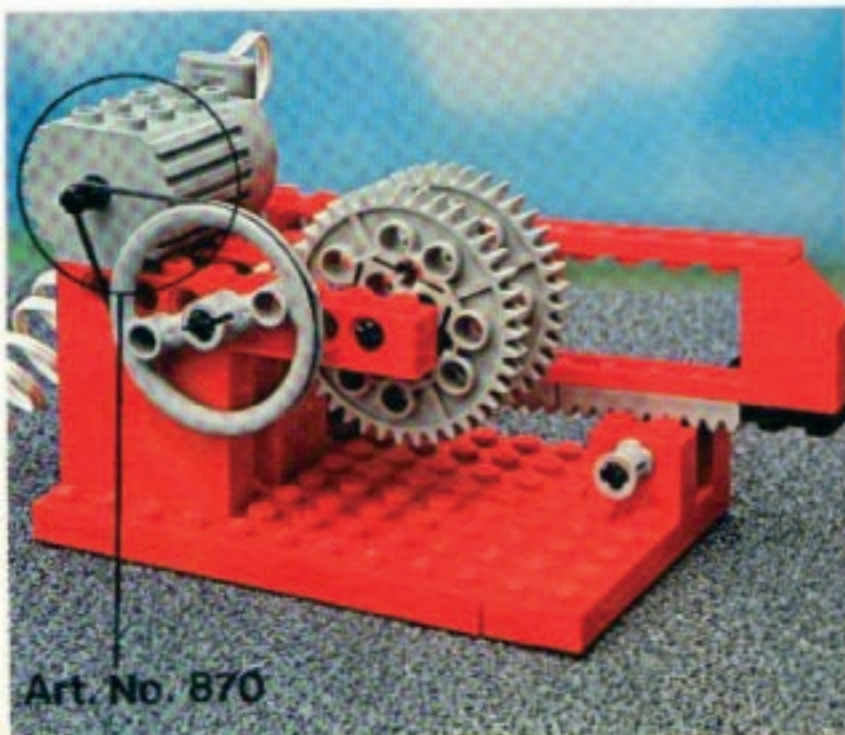
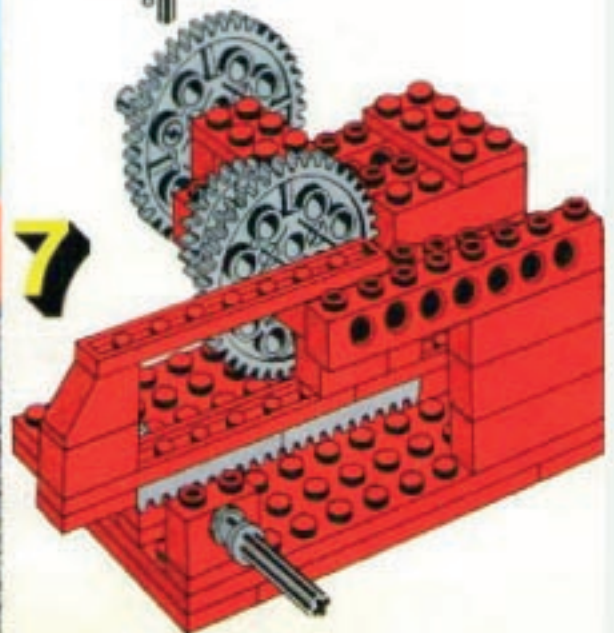

Art. No. 870

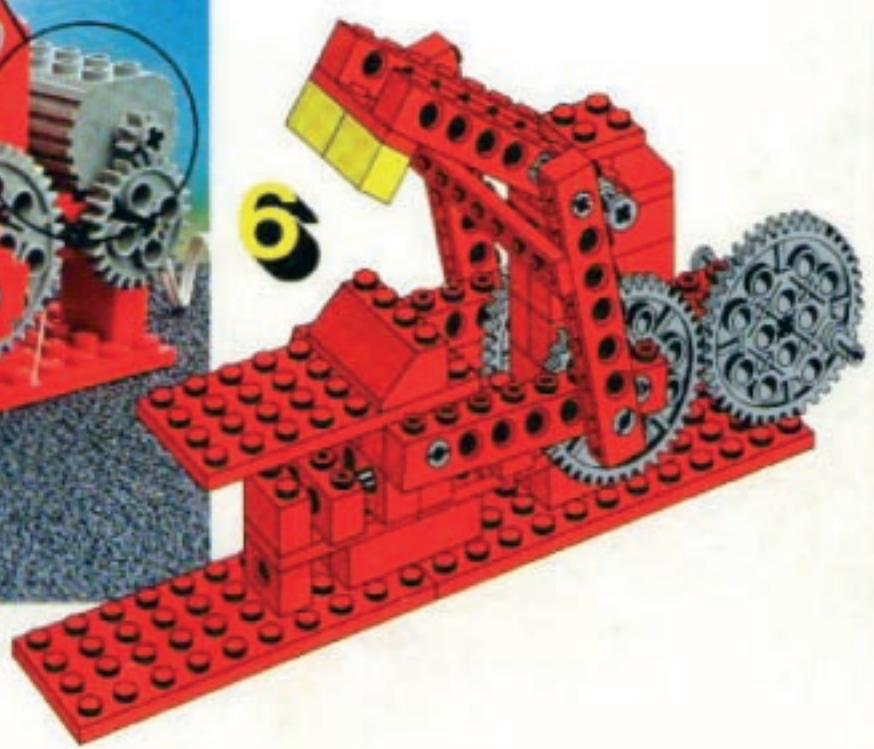
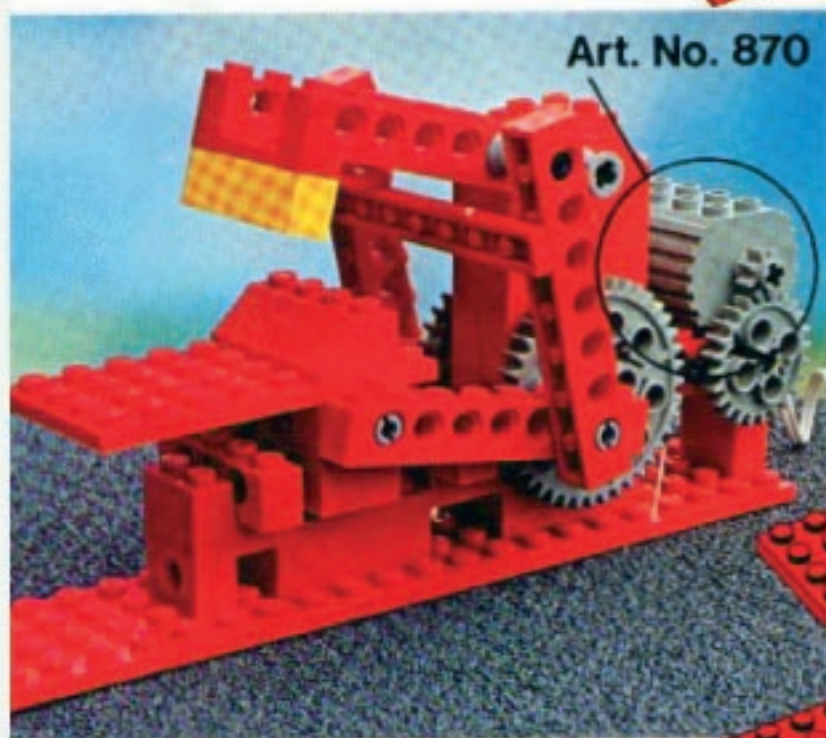
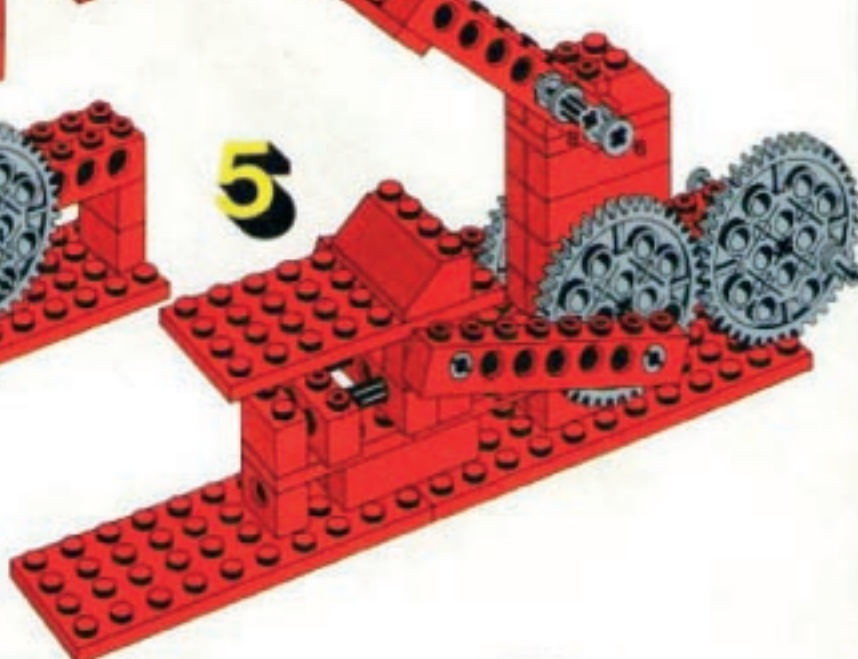
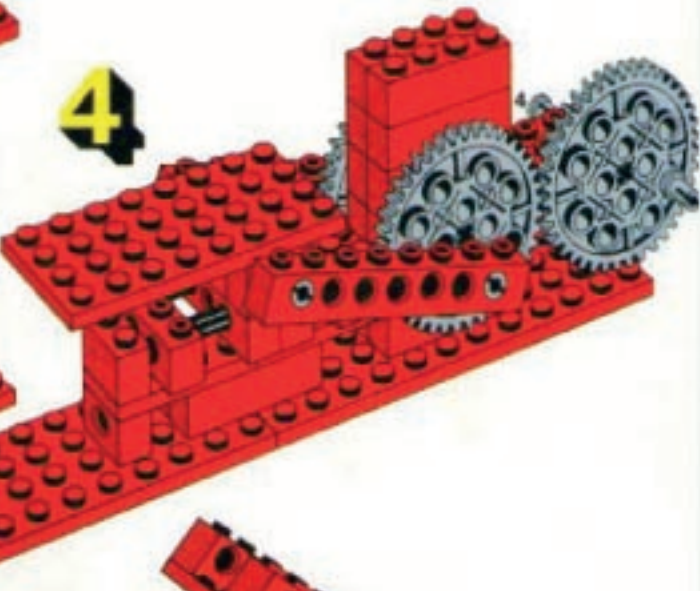
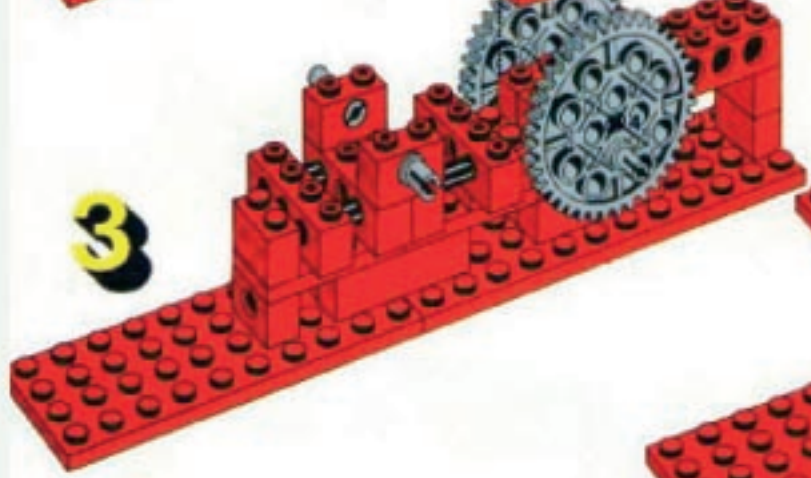
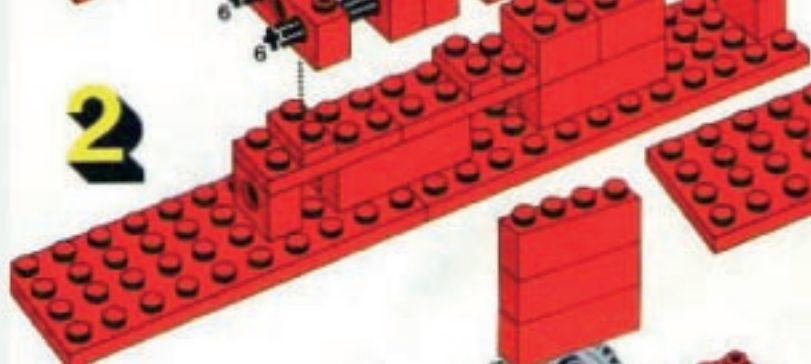

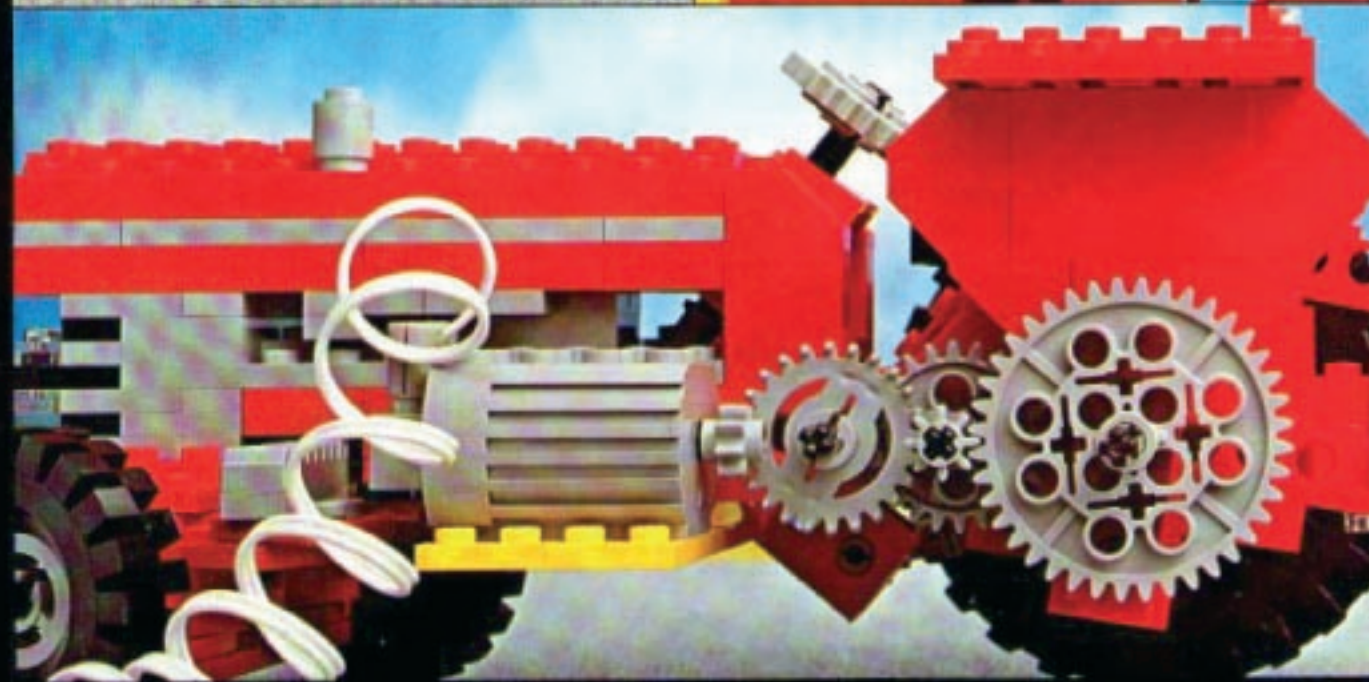
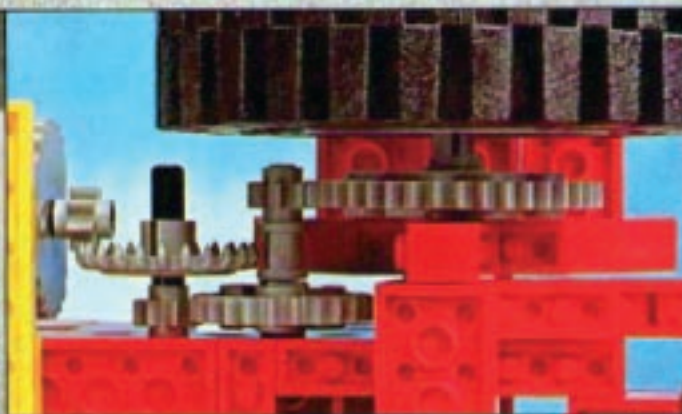

D Wenn der Traktor stark belastet wird (z.B. beim Verwenden schwerer Geräte), ist es vorteilhaft, die Aufhängung zu verstärken.

Auf den Bildern der Rückseite dieses Bogens wird ein Vorschlag gezeigt, wie Du die Modelle selbst umbauen kannst. Du fängst damit an, die Hinterräder abzumontieren, und einige Elemente welche auf den Bildern 26 und 27 gezeigt werden. Danach konstruierst Du eine neue Aufhängung für die Geräte, welche auf den Bildern 28-31 gezeigt werden. Zuletzt montierst Du die Räder.

UK When heavy tools are fitted to the tractor you will need a stronger suspension system than shown in the main construction drawings. This sheet shows you how to do this.

First remove the rear wheels and other elements shown in pictures 26 and 27. Then build a new suspension for tools as shown in pictures 28/31 and finally replace the wheels.

F Si le tracteur est trop chargé (par exemple lorsqu'on utilise de gros outils) on a intérêt à renforcer la suspension.

Au dos de cette page, vous avez toutes les explications pour transformer vous-mêmes votre maquette. Images 26 et 27: vous commencez par démonter les roues arrière et certains éléments. Images 28 à 31: puis vous construisez la nouvelle suspension pour les outils. Et vous remontez les roues.

NL Als je de tractor extra sterk wilt hebben kun je zelf de ophanging (van de werktuigen aan de hef-inrichting) nog steviger maken.

De plaatjes hier achterop geven een voorbeeld daarvan. Haal dan eerst de achterwielen en de elementen van plaatje 26 en 27 er weer af en bouw daarna de ophanging volgens de plaatjes 28 tot 31. Breng tenslotte de achterwielen weer aan.

I Quando caricate il trattore con attrezzi di peso rilevante e bene rinforzare le sospensioni.

Le illustrazioni riportate sul retro della pagina vi suggeriscono come modificare il modello. Prima di tutto smontate le ruote posteriori e gli elementi indicati nelle figure 26 e 27, poi costruite una nuova sospensione per gli attrezzi come indicato nelle figure 28 - 31. Infine rimontate le ruote.

N Hvis traktoren belastes hardt (f.eks. når det bruges tunge redskaber), kan det være en fordel at forsterke ophængen.

Bak på dette arket vises et forslag på hvordan du selv kan bygge om modellen. Du starter med at montere av bakhjulene og de elementene som er vist på bildene 26 og 27. Deretter konstruerer du et nytt opheng til redskaper som vist på bildene 28 - 31. Til sist setter du igjen hjulene på.

S Om du belastar traktorn med tunga redskap bör Du förstärka upphängningsanordningen. På baksidan av detta ark ger vi Dig förslag på hur Du skall gå tillväga. Du börjar med att montera av bakhjulen samt de element som visas på bild 26 och 27. Sedan bygger Du en ny upphängningsanordning som visas på bild 28 - 31. Till sist sätter Du på alla hjulen.

DK Hvis traktoren belastes hårdt (f.eks. ved anvendelse af tunge redskaber), kan det være en fordel at forstærke ophængen.

På billederne bag på dette ark er vist et forslag til, hvorledes du selv kan ombygge modellen. Du starter med at afmontere baghjulene samt visse elementer som vist på billede 26 og 27. Derefter konstruerer du et nyt ophæng til redskaber som vist på billederne 28 - 31. Til sidst sætter du atter hjulene på.

SF Mikäli traktorin kovasti rasitetaan (esim. käyttämällä raskaita työvälineitä), voi olla eduksi vahvistaa kiinnityslaitetta.

Tämän arkin takasivulla näytetään, miten itse voit korjata mallin. Poistat ensiksi takapyörät sekä eräät määrätyt elementit, kuten kuvat 26 ja 27 näyttävät. Sen jälkeen rakennat uuden kiinnityslaitteen kuvien 28 - 31 mukaisesti. Lopuksi kiinnität pyörät uudestaan.

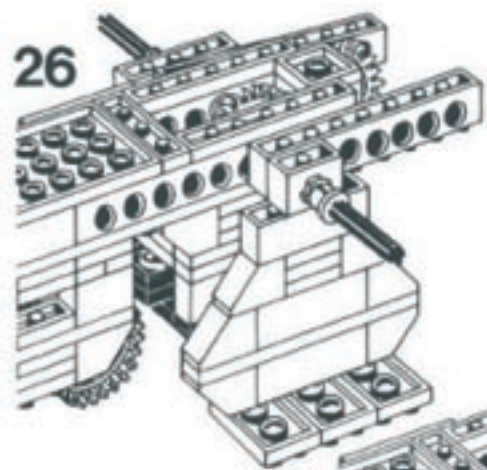

26

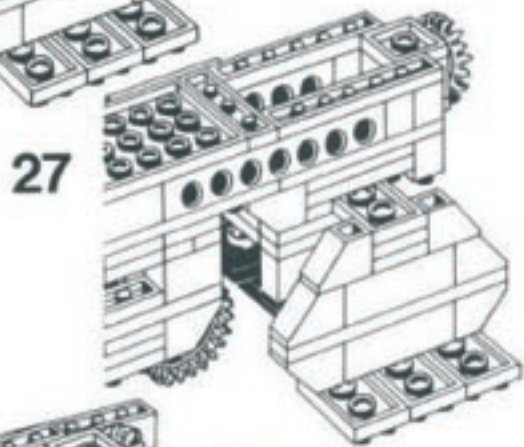

27

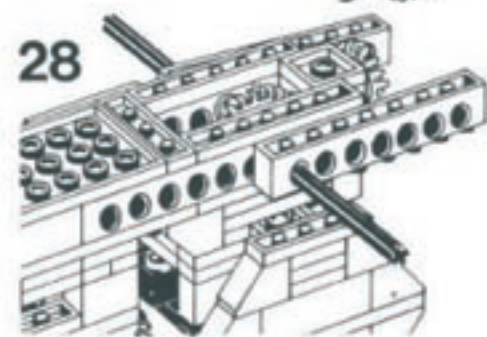

28

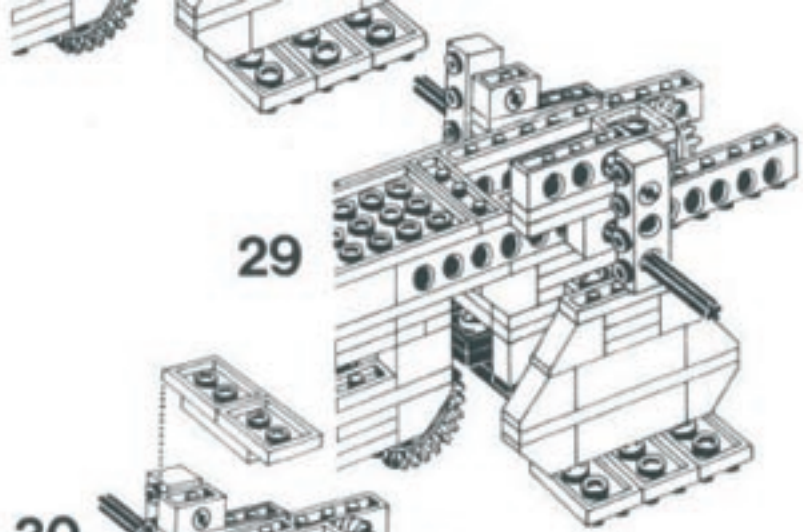



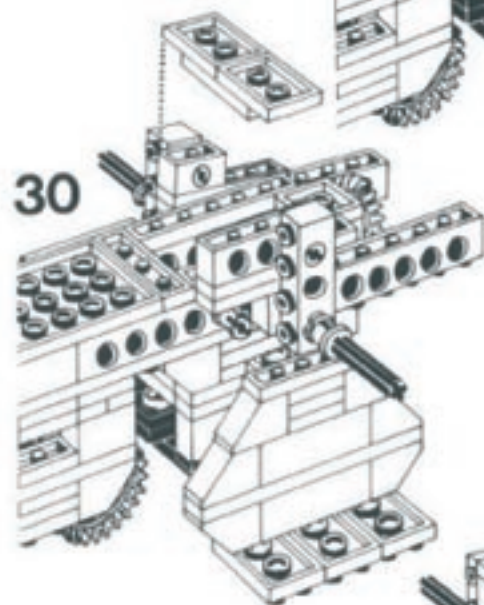



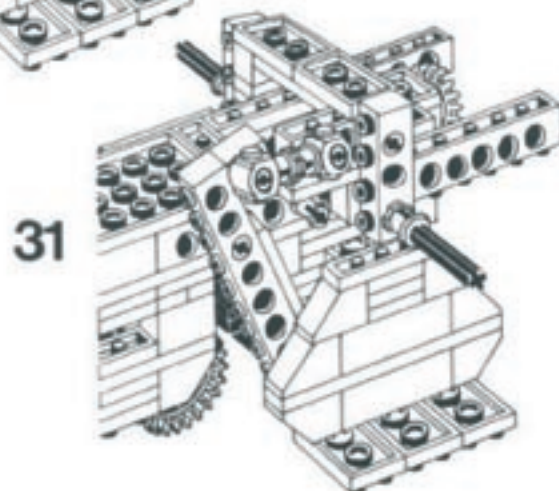



29



30

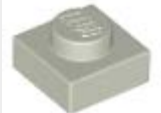

31

Image	Qty	Item No	Description	MID
Regular Items:				
Parts:				
 *	2	3005	Red Brick 1 x 1 Catalog: Parts: Brick	PG
 *	1	3004	Black Brick 1 x 2 Catalog: Parts: Brick	PG
 *	6	3004	Red Brick 1 x 2 Catalog: Parts: Brick	PG
 *	6	3004	Yellow Brick 1 x 2 Catalog: Parts: Brick	PG
 *	10	3010	Red Brick 1 x 4 Catalog: Parts: Brick	PG
 *	2	3003old	Red Brick 2 x 2 without Inside Supports Catalog: Parts: Brick	PG
 *	3	3062a	Light Gray Brick, Round 1 x 1 Solid Stud Catalog: Parts: Brick, Round	PG
 *	1	3062a	Red Brick, Round 1 x 1 Solid Stud Catalog: Parts: Brick, Round	PG
 *	1	3149c01(inv)	Red Hinge Plate 2 x 4 Catalog: Parts: Hinge	PG
 *	6	3024	Light Gray Plate 1 x 1 Catalog: Parts: Plate	PG
 *	2	3024	Red Plate 1 x 1 Catalog: Parts: Plate	PG

+  5 [3024](#) **Trans-Clear Plate 1 x 1** [PG](#)
[Catalog:](#) [Parts:](#) [Plate](#)

+  4 [3023](#) **Black Plate 1 x 2** [PG](#)
[Catalog:](#) [Parts:](#) [Plate](#)

+  15 [3023](#) **Light Gray Plate 1 x 2** [PG](#)
[Catalog:](#) [Parts:](#) [Plate](#)

+  17 [3023](#) **Red Plate 1 x 2** [PG](#)
[Catalog:](#) [Parts:](#) [Plate](#)

+  3 [3710](#) **Black Plate 1 x 4** [PG](#)
[Catalog:](#) [Parts:](#) [Plate](#)

+  3 [3710](#) **Light Gray Plate 1 x 4** [PG](#)
[Catalog:](#) [Parts:](#) [Plate](#)

+  18 [3710](#) **Red Plate 1 x 4** [PG](#) 1 
[Catalog:](#) [Parts:](#) [Plate](#)









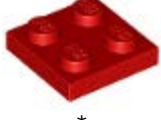

+  6 [3666](#) **Red Plate 1 x 6** [PG](#)
[Catalog:](#) [Parts:](#) [Plate](#)

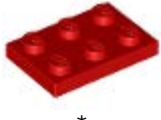









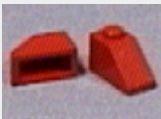

+  5 [3460](#) **Light Gray Plate 1 x 8** [PG](#)
[Catalog:](#) [Parts:](#) [Plate](#)

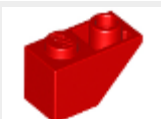













+  10 [3460](#) **Red Plate 1 x 8** [PG](#) 1 
[Catalog:](#) [Parts:](#) [Plate](#)

+  2 [3022](#) **Black Plate 2 x 2** [PG](#)
[Catalog:](#) [Parts:](#) [Plate](#)

+  4 [3022](#) **Red Plate 2 x 2** [PG](#)
[Catalog:](#) [Parts:](#) [Plate](#)

+	 *	6	3022	Yellow Plate 2 x 2 Catalog: Parts: Plate	PG
+	 *	1	3021	Black Plate 2 x 3 Catalog: Parts: Plate	PG
+	 *	1	3021	Light Gray Plate 2 x 3 Catalog: Parts: Plate	PG
+	 *	12	3021	Red Plate 2 x 3 Catalog: Parts: Plate	PG
+	 *	5	3020	Light Gray Plate 2 x 4 Catalog: Parts: Plate	PG
+	 *	10	3020	Red Plate 2 x 4 Catalog: Parts: Plate	PG
+	 *	2	3034	Light Gray Plate 2 x 8 Catalog: Parts: Plate	PG
+	 *	2	3034	Red Plate 2 x 8 Catalog: Parts: Plate	PG
+	 *	1	3035	Red Plate 4 x 8 Catalog: Parts: Plate	PG
+	 *	1	3030	Red Plate 4 x 10 Catalog: Parts: Plate	PG
+	 *	1	3029	Red Plate 4 x 12 Catalog: Parts: Plate	PG
+	 *	2	8c01 (inv)	Red Plate, Modified 2 x 2 with Wheel Holder Bottom and Red Wheel with Black Tire 14mm D. x 4mm Smooth Small Single (8 / 3464 / 3139) Catalog: Parts: Aircraft	PG

+	 *	2	3298	Red Slope 33 3 x 2 Catalog: Parts: Slope	PG		
+	 *	2	3040a	Black Slope 45 2 x 1 - without Bottom Tube Catalog: Parts: Slope	PG		
+	 *	6	3040a	Red Slope 45 2 x 1 - without Bottom Tube Catalog: Parts: Slope	PG		
+	 *	1	3037	Red Slope 45 2 x 4 Catalog: Parts: Slope	PG		
+	 *	8	3665	Red Slope, Inverted 45 2 x 1 Catalog: Parts: Slope, Inverted	PG		
+	 *	14	3713	Light Gray Technic Bush Catalog: Parts: Technic	PG	1	
+	 *	1	3704	Black Technic, Axle 2 Catalog: Parts: Technic, Axle	PG		
+	 *	2	3705	Black Technic, Axle 4 Catalog: Parts: Technic, Axle	PG		
+	 *	9	3706	Black Technic, Axle 6 Catalog: Parts: Technic, Axle	PG		
+	 *	3	3707	Black Technic, Axle 8 Catalog: Parts: Technic, Axle	PG		
+	 *	2	3651	Light Gray Technic, Axle and Pin Connector Catalog: Parts: Technic, Connector	PG		
+	 *	15	3700	Red Technic, Brick 1 x 2 with Hole Catalog: Parts: Technic, Brick	PG		

+	 *	11	3701	Red Technic, Brick 1 x 4 with Holes Catalog: Parts: Technic, Brick	PG		
+	 *	8	3702	Red Technic, Brick 1 x 8 with Holes Catalog: Parts: Technic, Brick	PG		
+	 *	4	3647	Light Gray Technic, Gear 8 Tooth Type 1 Catalog: Parts: Technic, Gear	PG		
+	 *	1	x187	Light Gray Technic, Gear 24 Tooth (1st Version - 3 Axle Holes) Catalog: Parts: Technic, Gear	PG		
+	 *	2	3650a	Light Gray Technic, Gear 24 Tooth Crown (1st Version - Not Reinforced) Catalog: Parts: Technic, Gear	PG	2	
+	 *	4	3649	Light Gray Technic, Gear 40 Tooth Catalog: Parts: Technic, Gear	PG		
+	 *	2	3743	Light Gray Technic, Gear Rack 1 x 4 Catalog: Parts: Technic, Gear	PG		
+	 *	7	3673	Light Gray Technic, Pin without Friction Ridges Lengthwise Catalog: Parts: Technic, Pin	PG	1	
+	 *	3	3709b	Red Technic, Plate 2 x 4 with 3 Holes Catalog: Parts: Technic, Plate	PG		
+	 *	5	3738	Red Technic, Plate 2 x 8 with 7 Holes Catalog: Parts: Technic, Plate	PG		
+	 *	1	9244c01(inv)	Light Gray Technic, Universal Joint 4L Catalog: Parts: Technic, Connector	PG		
+	 *	2	3069a	Red Tile 1 x 2 without Groove Catalog: Parts: Tile	PG		

+	 *	2	3634	Black Tire 17 x 43 Catalog: Parts: Tire & Tread	PG
---	---------------------------------------------------------------------------------------	---	----------------------	-------------------------------------------------------------------------------	--------------------

+	 *	2	3740	Black Tire 24 x 43 Technic Catalog: Parts: Tire & Tread	PG
---	----------------------------------------------------------------------------------------	---	----------------------	---------------------------------------------------------------------------------------	--------------------

+	 *	6	3680c01 (inv)	Red Turntable 2 x 2 Plate, Base with Light Gray Turntable 2 x 2 Plate, Top (3680 / 3679) Catalog: Parts: Turntable	PG
---	----------------------------------------------------------------------------------------	---	-------------------------------	----------------------------------------------------------------------------------------------------------------------------------------------	--------------------

+	 *	2	3739	Light Gray Wheel 24 x 43 Technic Catalog: Parts: Wheel	PG
---	----------------------------------------------------------------------------------------	---	----------------------	----------------------------------------------------------------------------------	--------------------

+	 *	2	3482	Light Gray Wheel with Split Axle Hole Catalog: Parts: Wheel	PG
---	----------------------------------------------------------------------------------------	---	----------------------	---------------------------------------------------------------------------------------	--------------------

Extra Items:

+	 *	3	3713	Light Gray Technic Bush Catalog: Parts: Technic	PG
---	-----------------------------------------------------------------------------------------	---	----------------------	---------------------------------------------------------------------------	--------------------

+	 *	1	3651	Light Gray Technic, Axle and Pin Connector Catalog: Parts: Technic, Connector	PG
---	------------------------------------------------------------------------------------------	---	----------------------	---------------------------------------------------------------------------------------------------------	--------------------

+	 *	1	3673	Light Gray Technic, Pin without Friction Ridges Lengthwise Catalog: Parts: Technic, Pin	PG
---	------------------------------------------------------------------------------------------	---	----------------------	-------------------------------------------------------------------------------------------------------------------	--------------------

Counterparts:

+	 *	2	3739c01 (inv)	Light Gray Wheel 24 x 43 Technic with Black Tire 24 x 43 Technic (3739 / 3740) Catalog: Parts: Wheel & Tire Assembly	PG
---	------------------------------------------------------------------------------------------	---	-------------------------------	----------------------------------------------------------------------------------------------------------------------------------------------------	--------------------

+	 *	2	3482c03 (inv)	Light Gray Wheel with Split Axle Hole with Black Tire 17 x 43 (3482 / 3634) Catalog: Parts: Wheel & Tire Assembly	PG
---	------------------------------------------------------------------------------------------	---	-------------------------------	-------------------------------------------------------------------------------------------------------------------------------------------------	--------------------

Alternate Items:

+	 *	4	3024	Red Plate 1 x 1 Catalog: Parts: Plate	PG 1
---	------------------------------------------------------------------------------------------	---	----------------------	-----------------------------------------------------------------	----------------------------------------------------------------------------------------------------------------------

+		20	3710	Red Plate 1 x 4 Catalog: Parts: Plate	PG	1	
	*						
+		11	3460	Red Plate 1 x 8 Catalog: Parts: Plate	PG	1	
	*						
+		15	3713	Light Gray Technic Bush Catalog: Parts: Technic	PG	1	
	*						
+		2	3650a	Black Technic, Gear 24 Tooth Crown (1st Version - Not Reinforced) Catalog: Parts: Technic, Gear	PG	2	
	*						
+		10	3673	Light Gray Technic, Pin without Friction Ridges Lengthwise Catalog: Parts: Technic, Pin	PG	1	
	*						

Note:

Redesigned during production.

There are at least 2 different versions of instructions for this set. The differences for the second version are indicated in this inventory in the Alternate Items section with Match ID 99.

Quick overview of redesign: The 3-point hitch is strengthened to handle heavier implements. Also, a spacer and a 1 x 8 plate are added to the main implement and two 1 x 1 plates are added under the seat.

Summary:

Type	Unique Lots	Total Qty
Regular Items:		
Parts	64	305
Extra Items:		
Parts	3	5
Counterparts:		
Parts	2	4
Alternative Items:		
Parts	6	62

[SimplyBricks \(17762\)](#)  inventoried this Set on Jan 26, 2006, inventory last updated on Apr 27, 2018.