



LEGO Fork lift truck 850

With Technical Set 850 you can build from the detailed construction plans this fork lift truck with steering to the rear wheels and a fork lift for raising and stacking heavy loads, just like those in big factories and warehouses.

But the same set can also be used for making other things too – a dumper truck, bulldozer or grader, among other things.



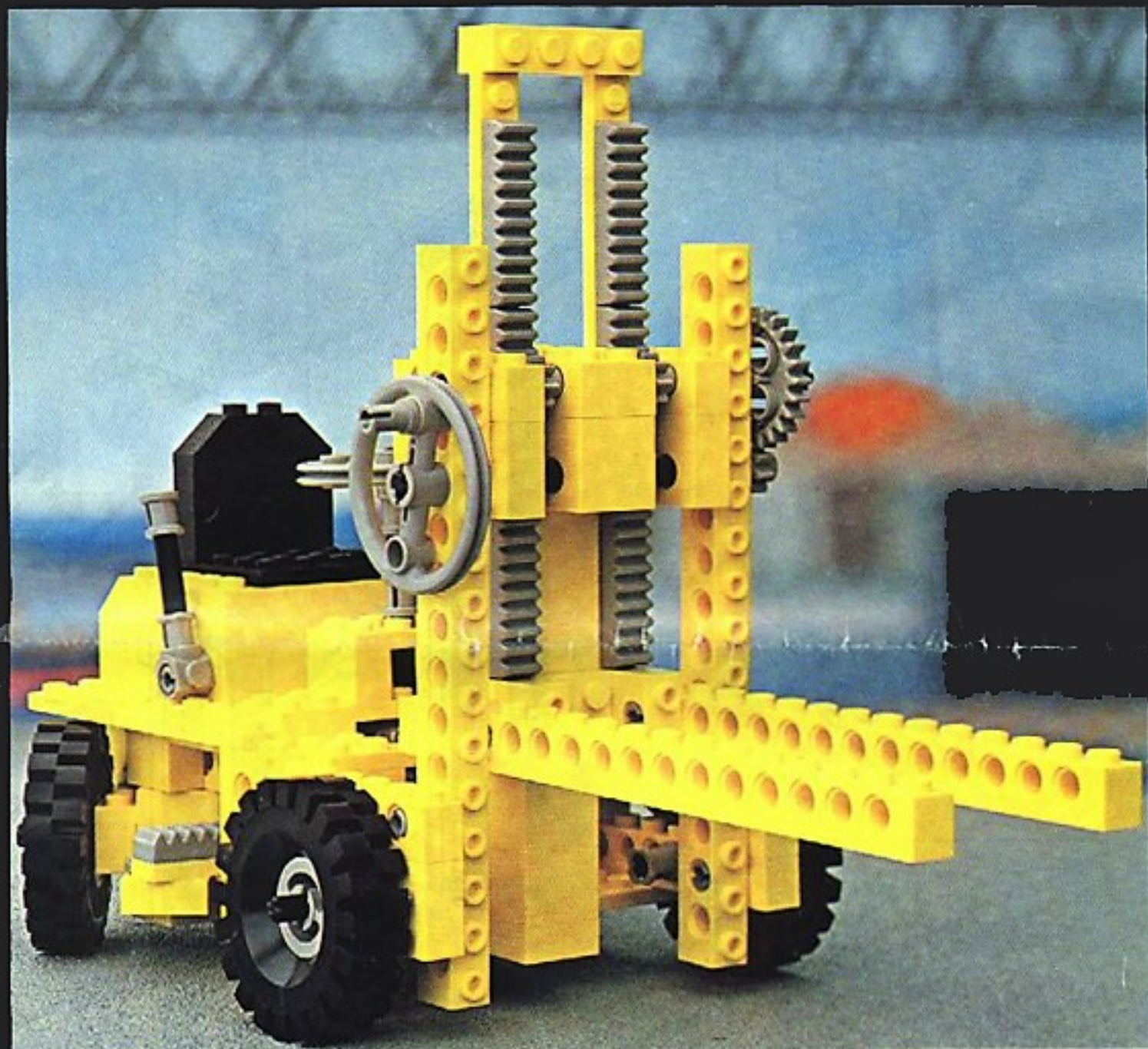

120055

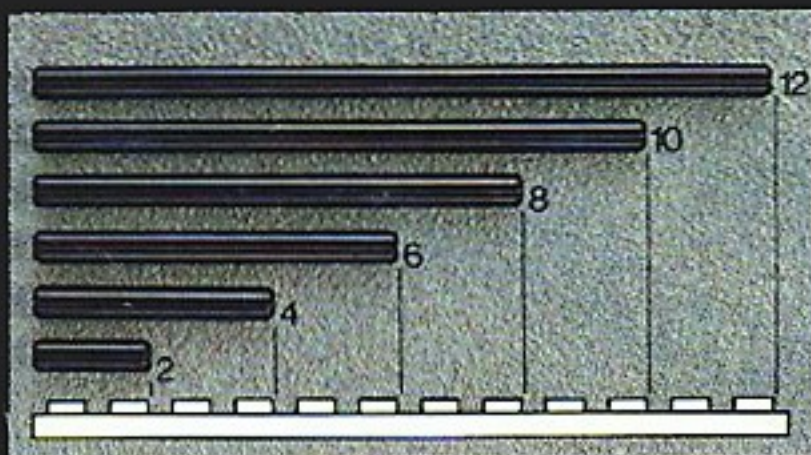

In der Bauanleitung steht vor den Achsen eine Zahl, die die benötigte Länge der Achsen anzeigt.

Numbers in the building instructions near axles show the length of axle to be used.

Dans les conseils de construction, il y a un chiffre à côté de chaque axe. Ce chiffre indique la longueur des axes à utiliser.

Ut for akslerne i byggeanvisningen er anført et tal som viser hvilken aksellengde som skal brukes.

1

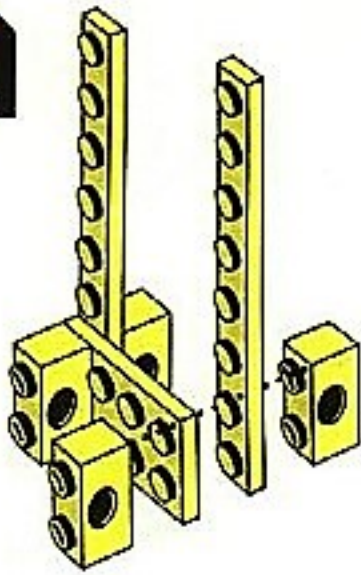

2

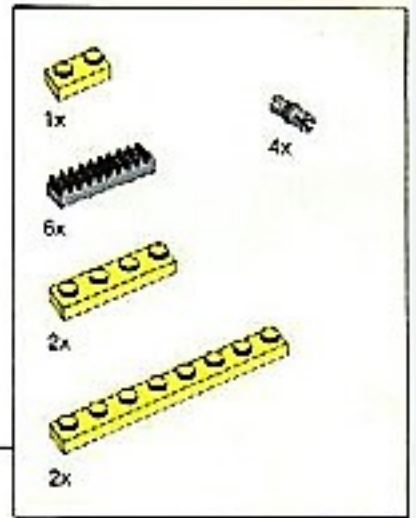
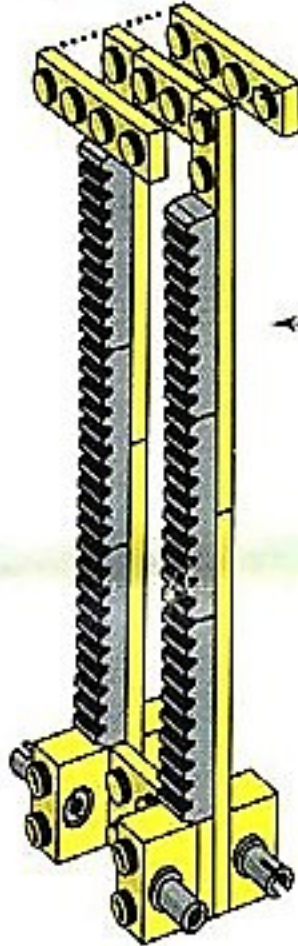

3

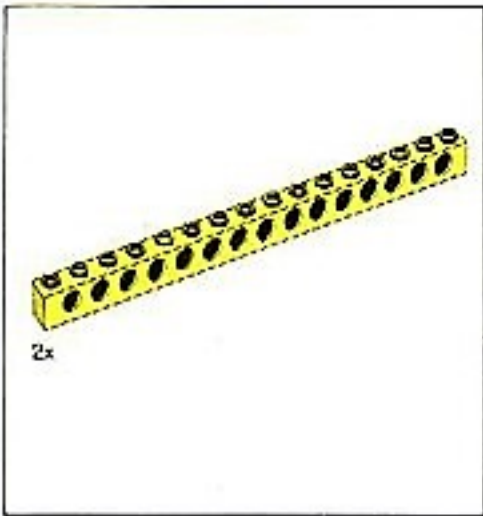
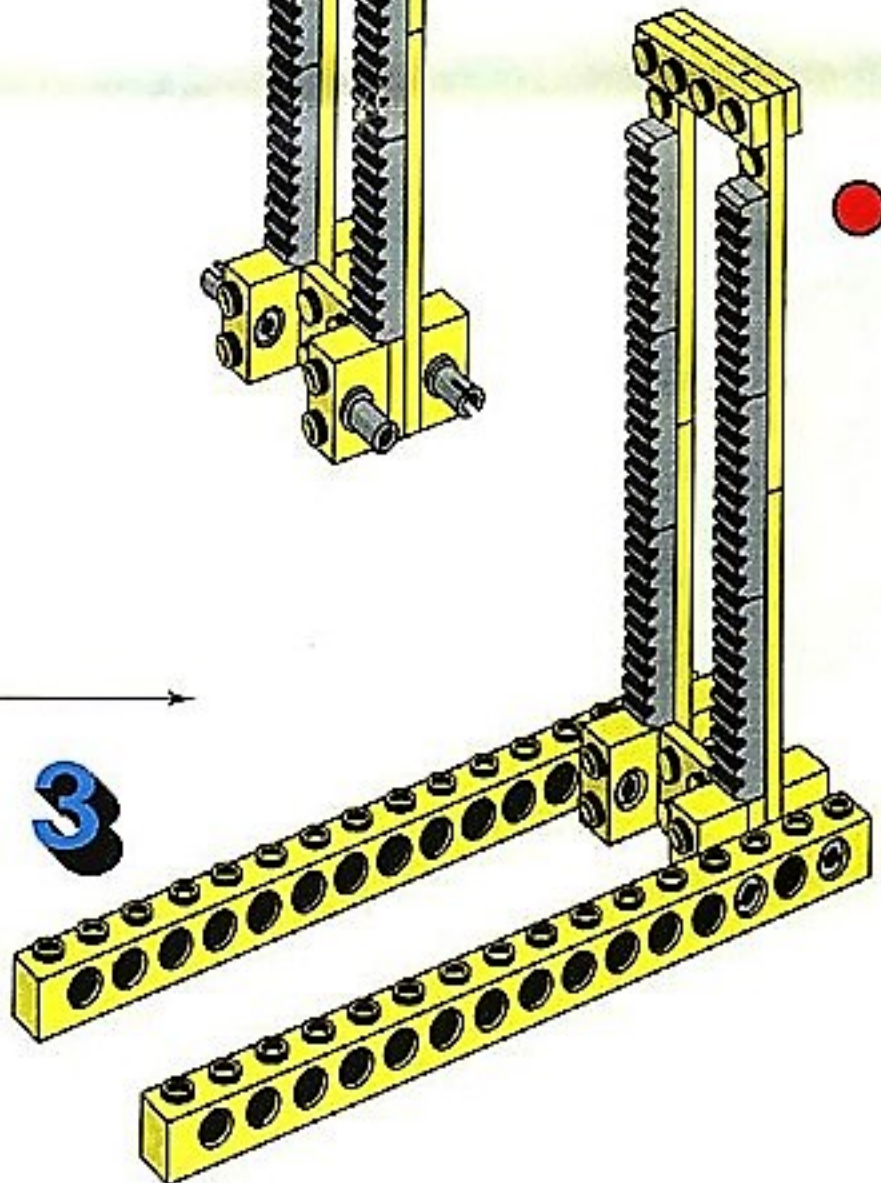

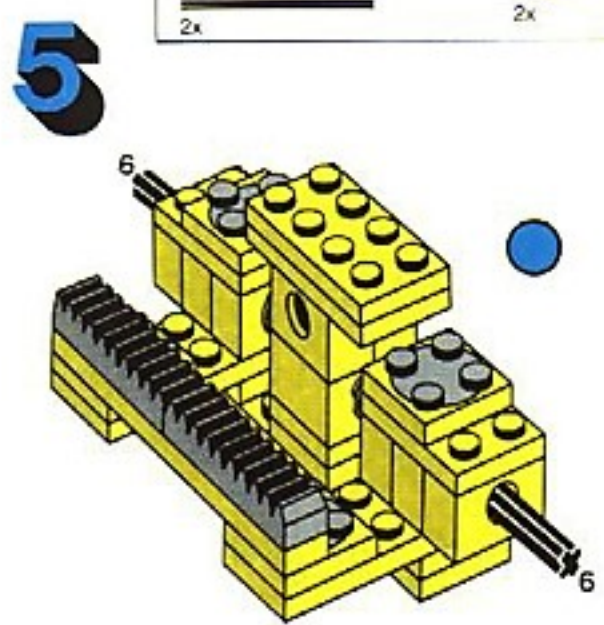
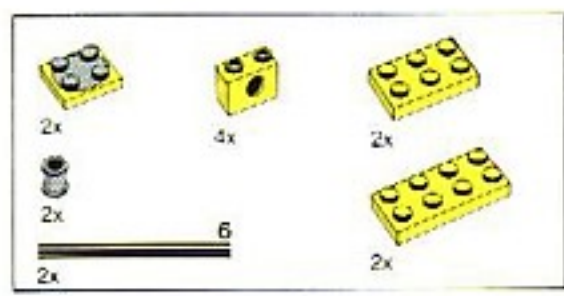
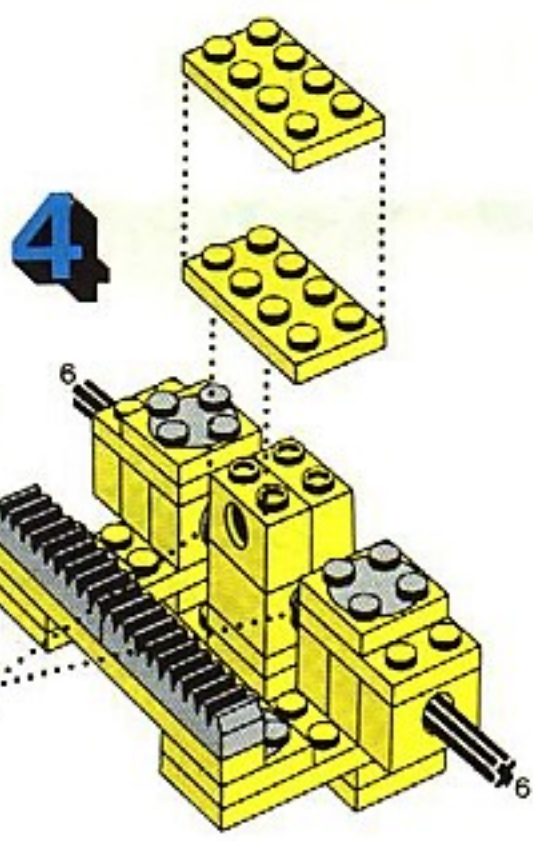
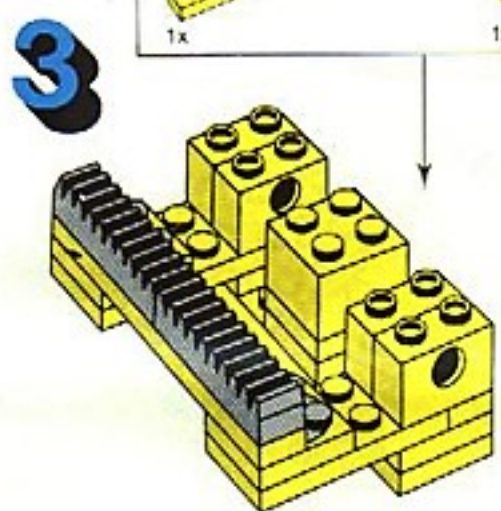
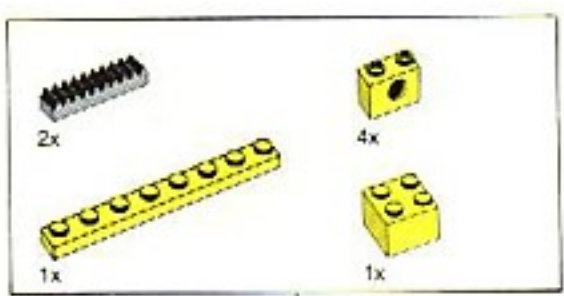
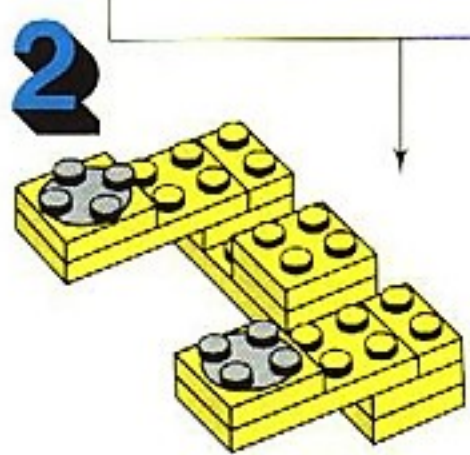
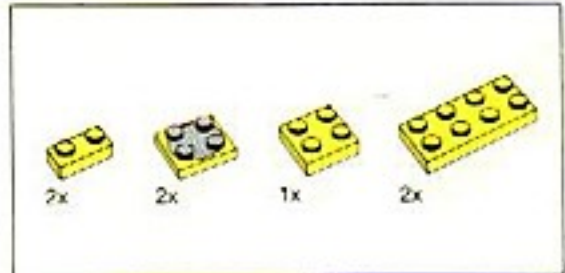
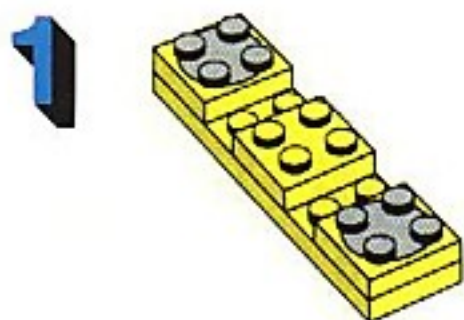

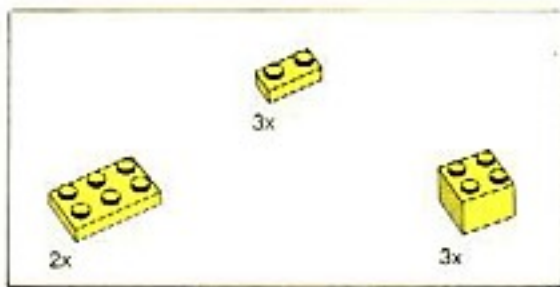
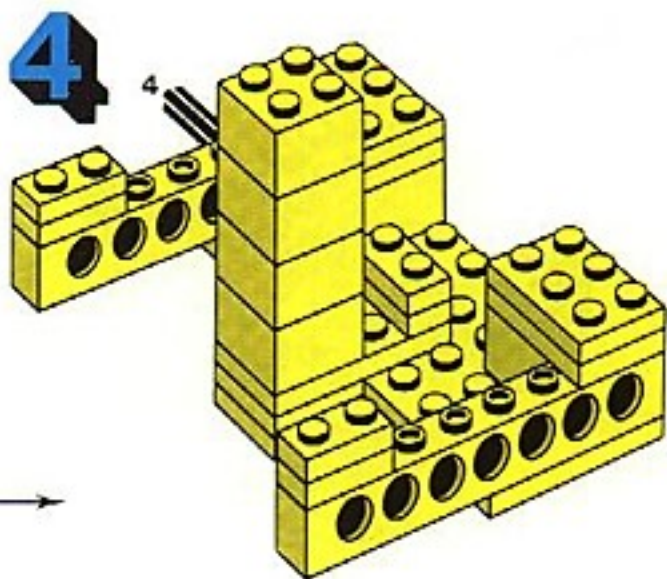
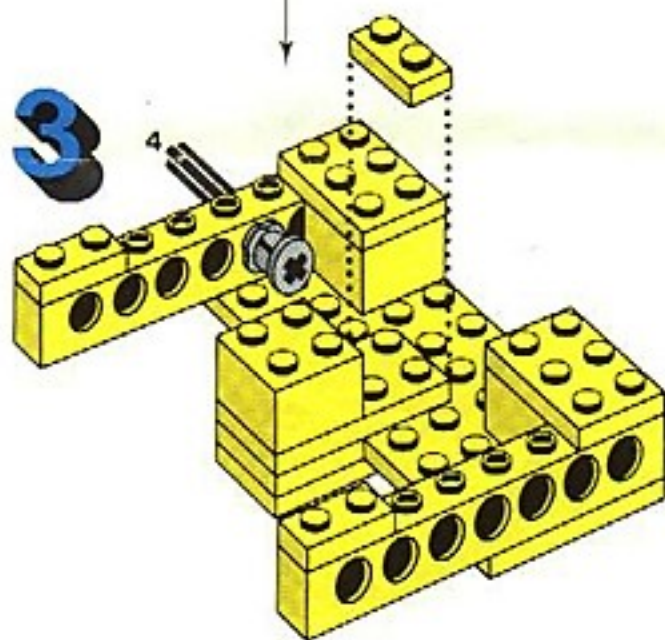
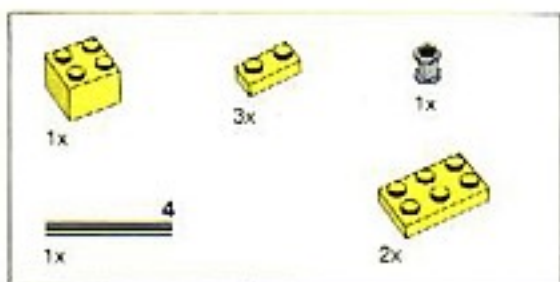
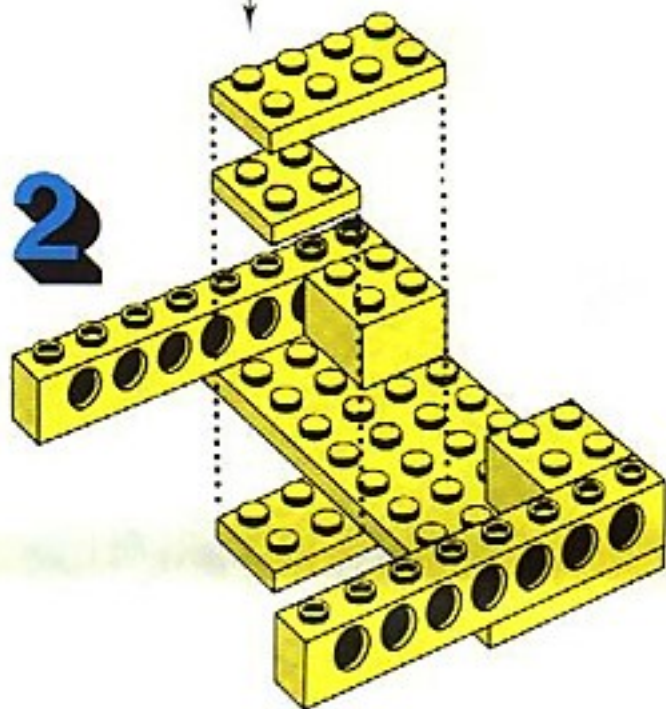
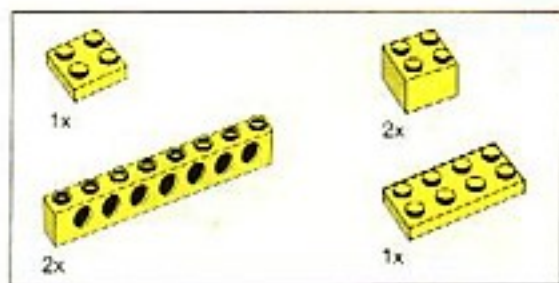
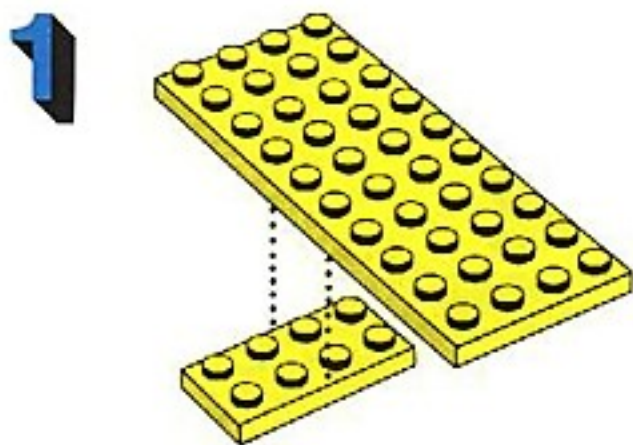

5

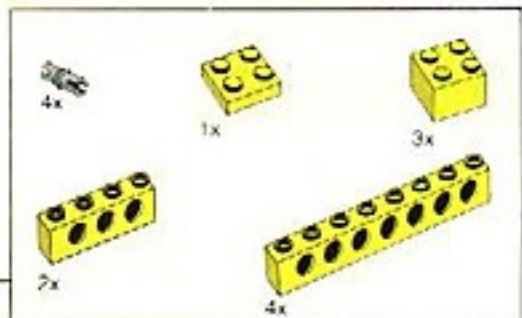
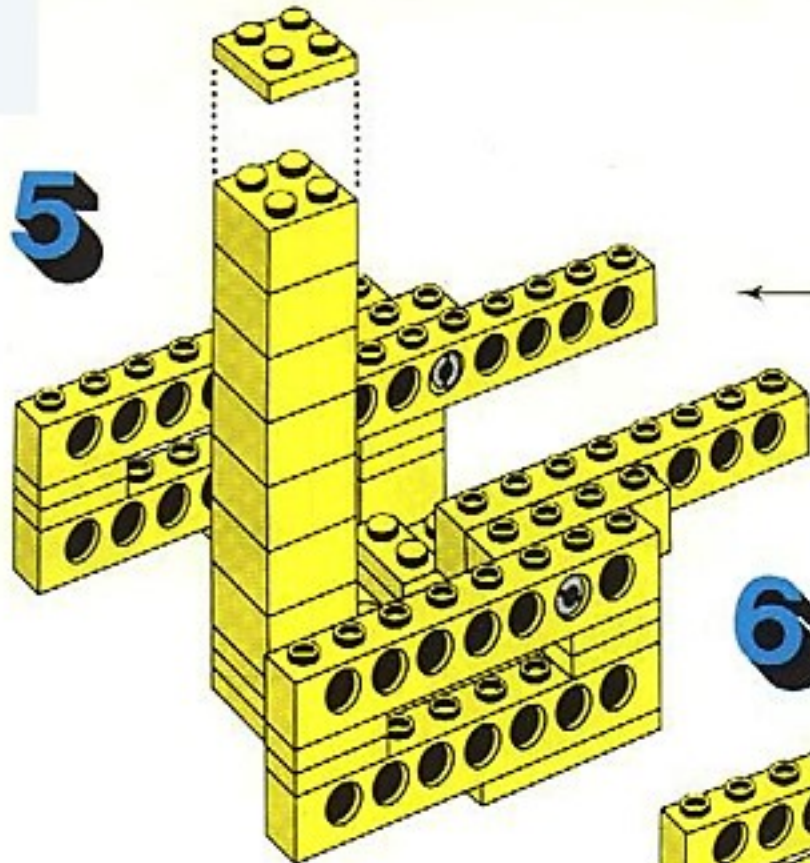

6

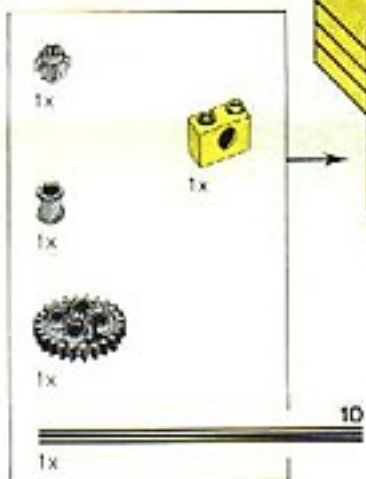
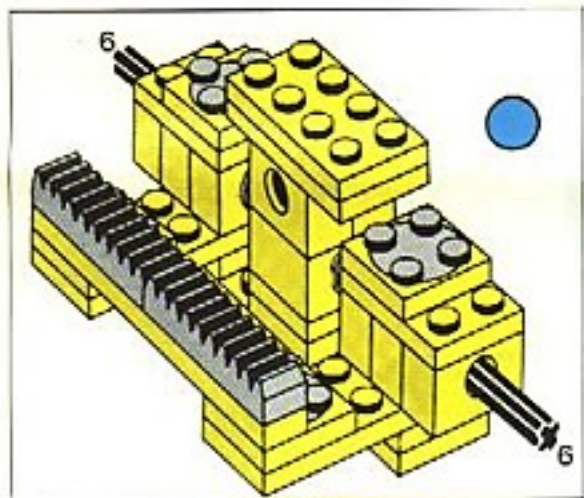
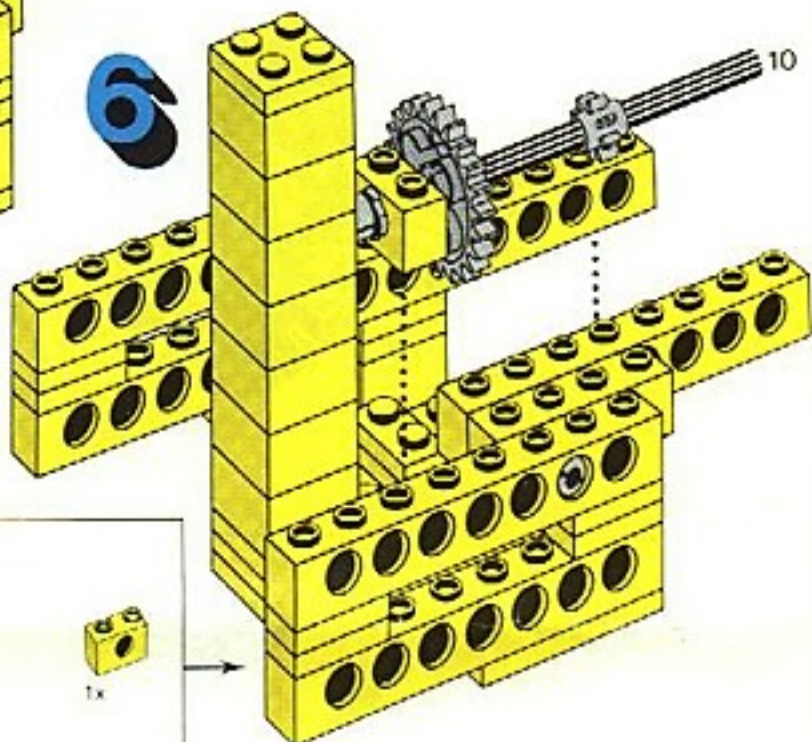

7

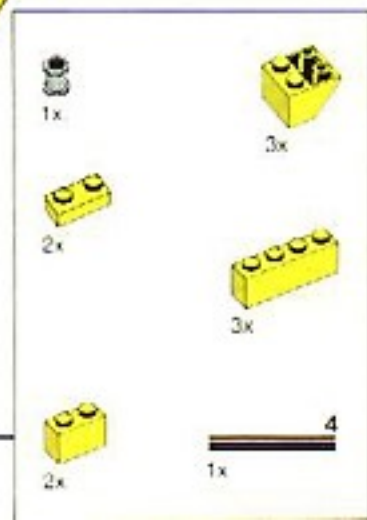
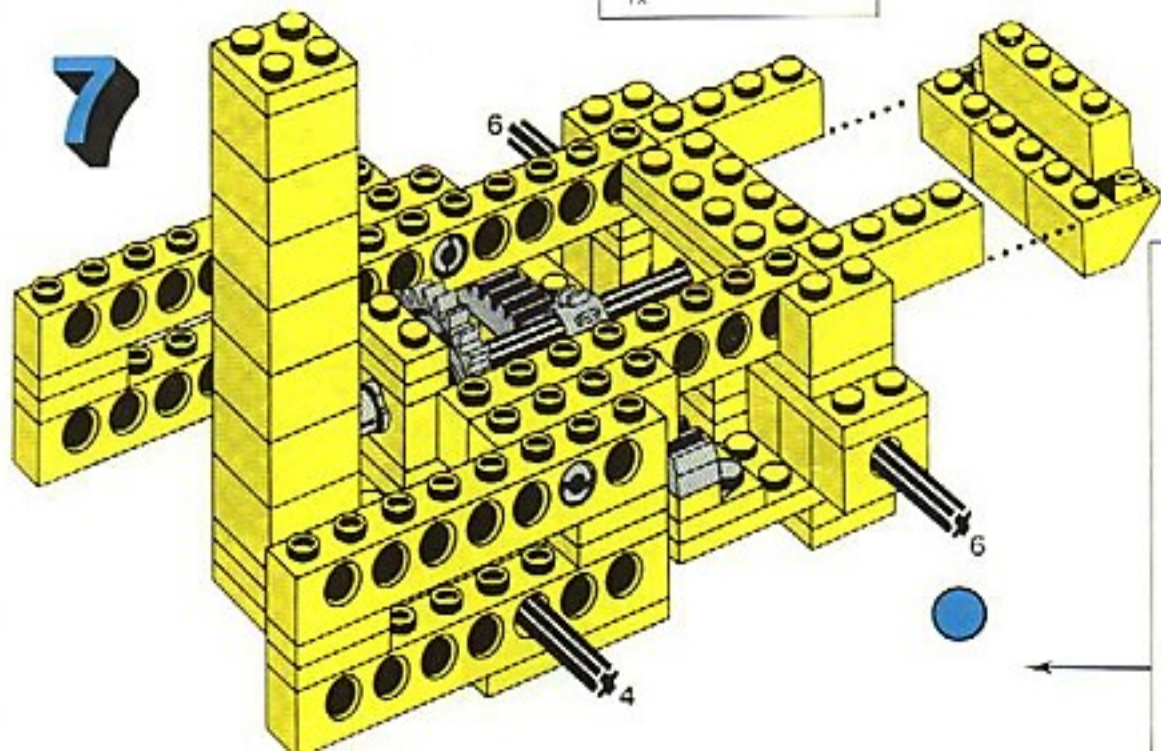

8

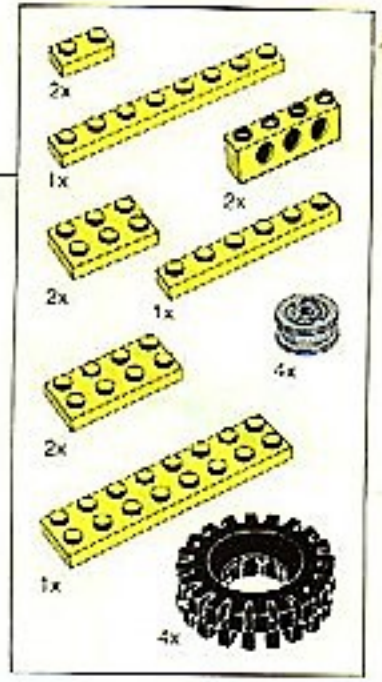
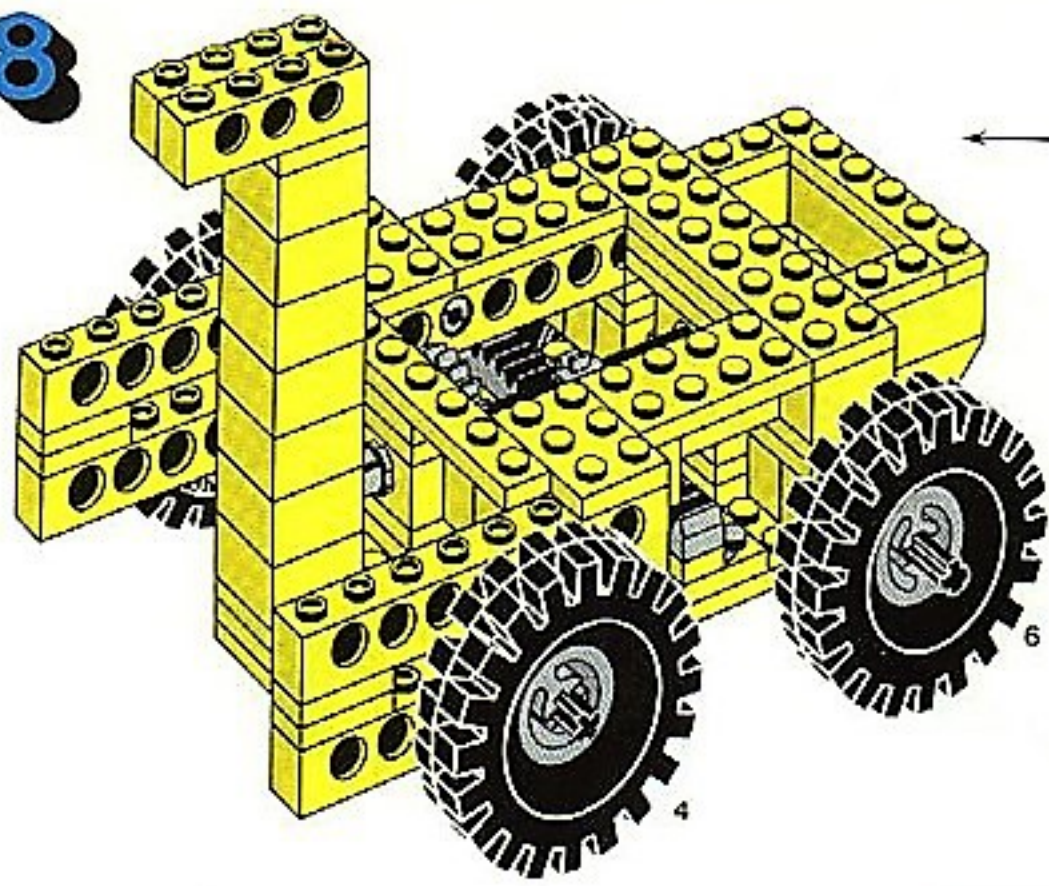

9

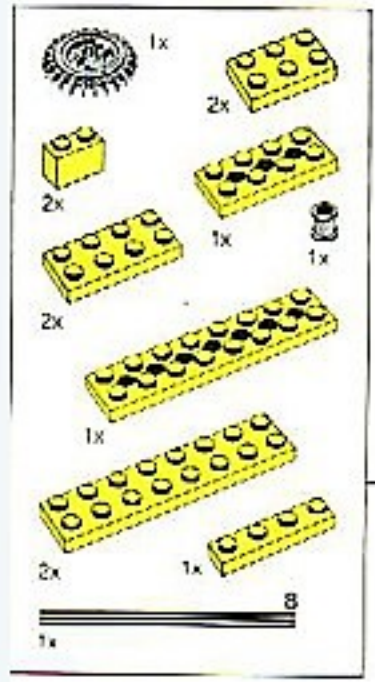
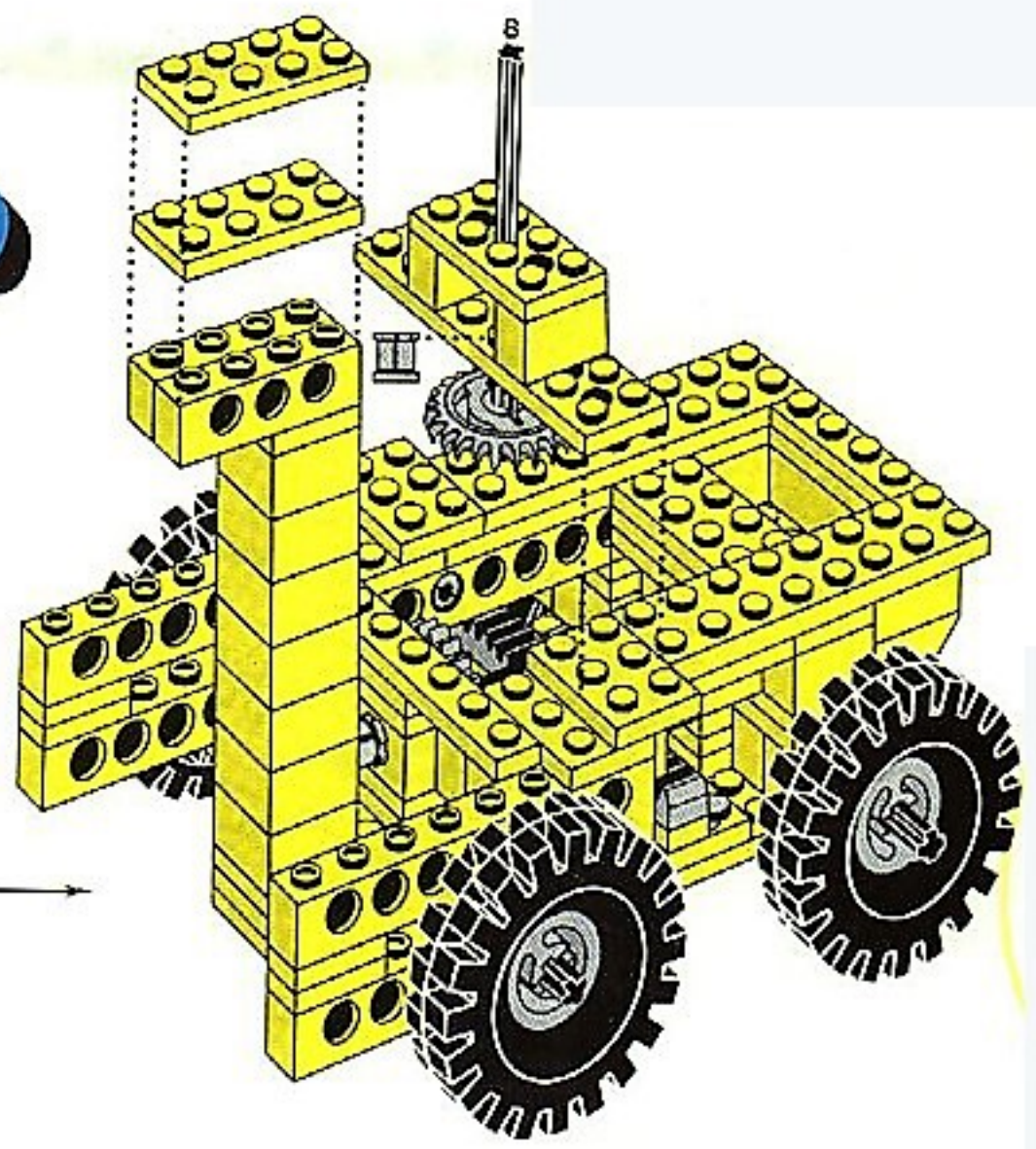

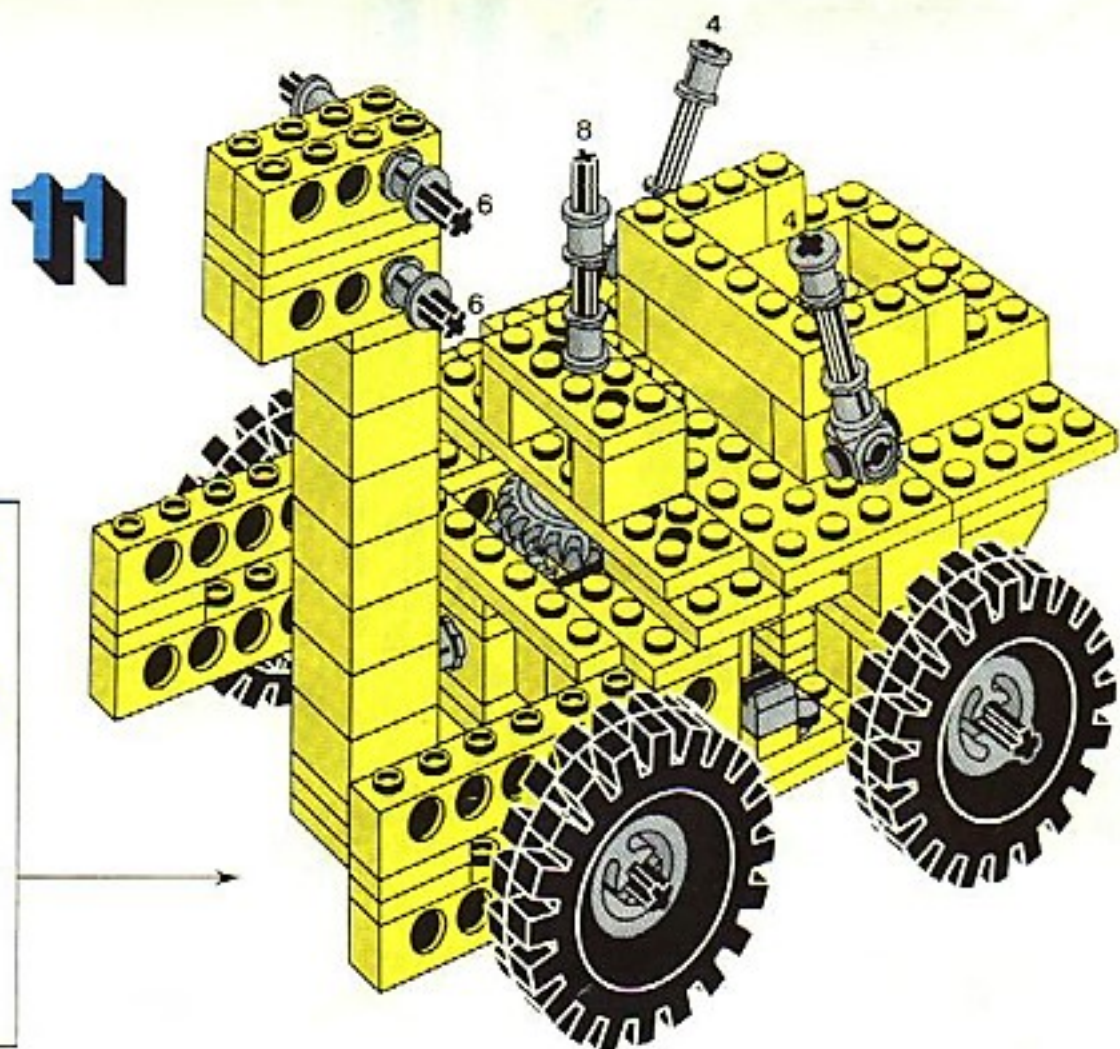
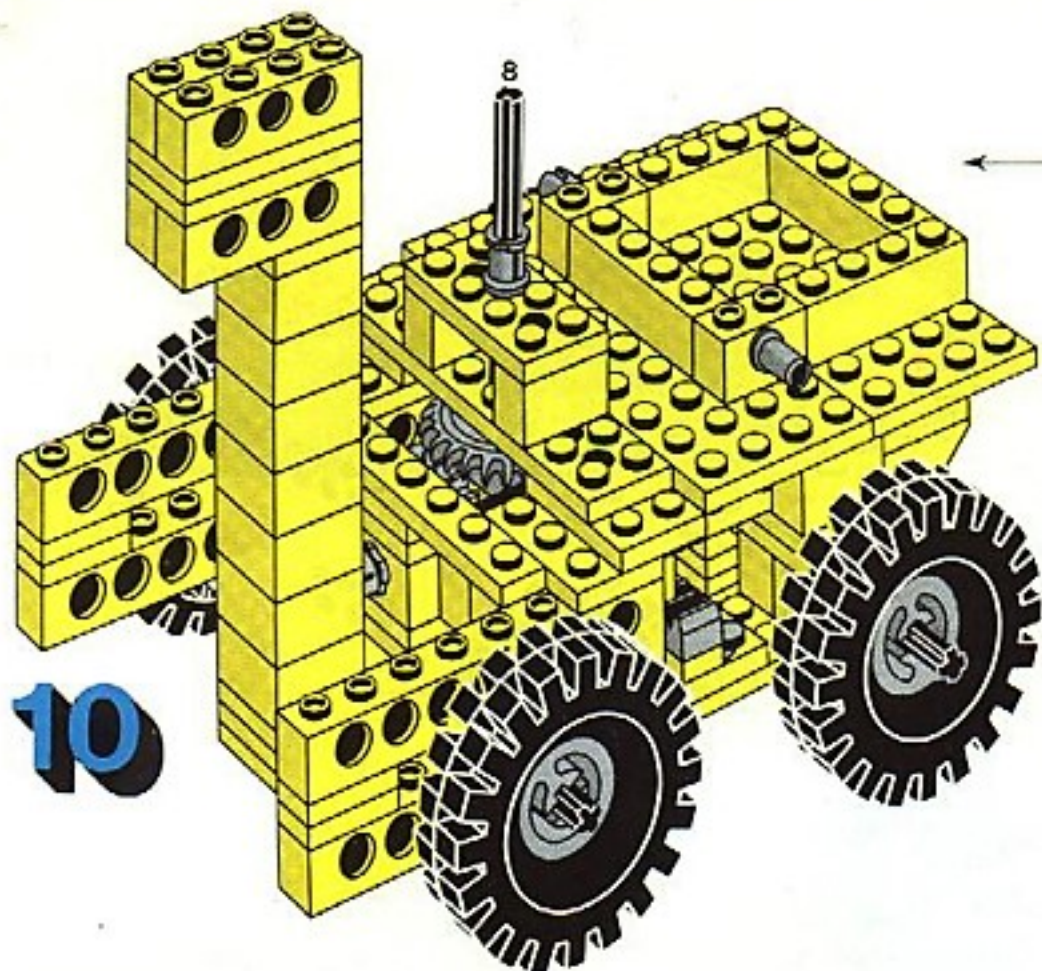

12

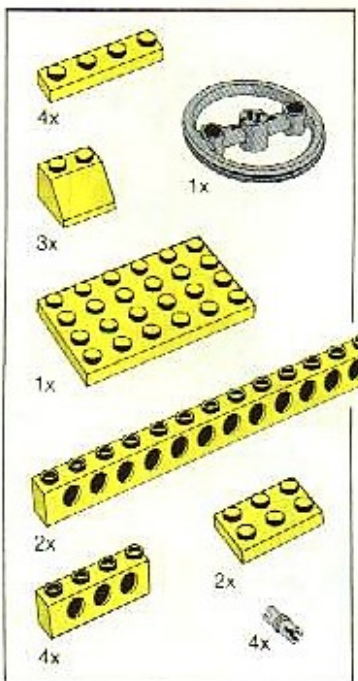
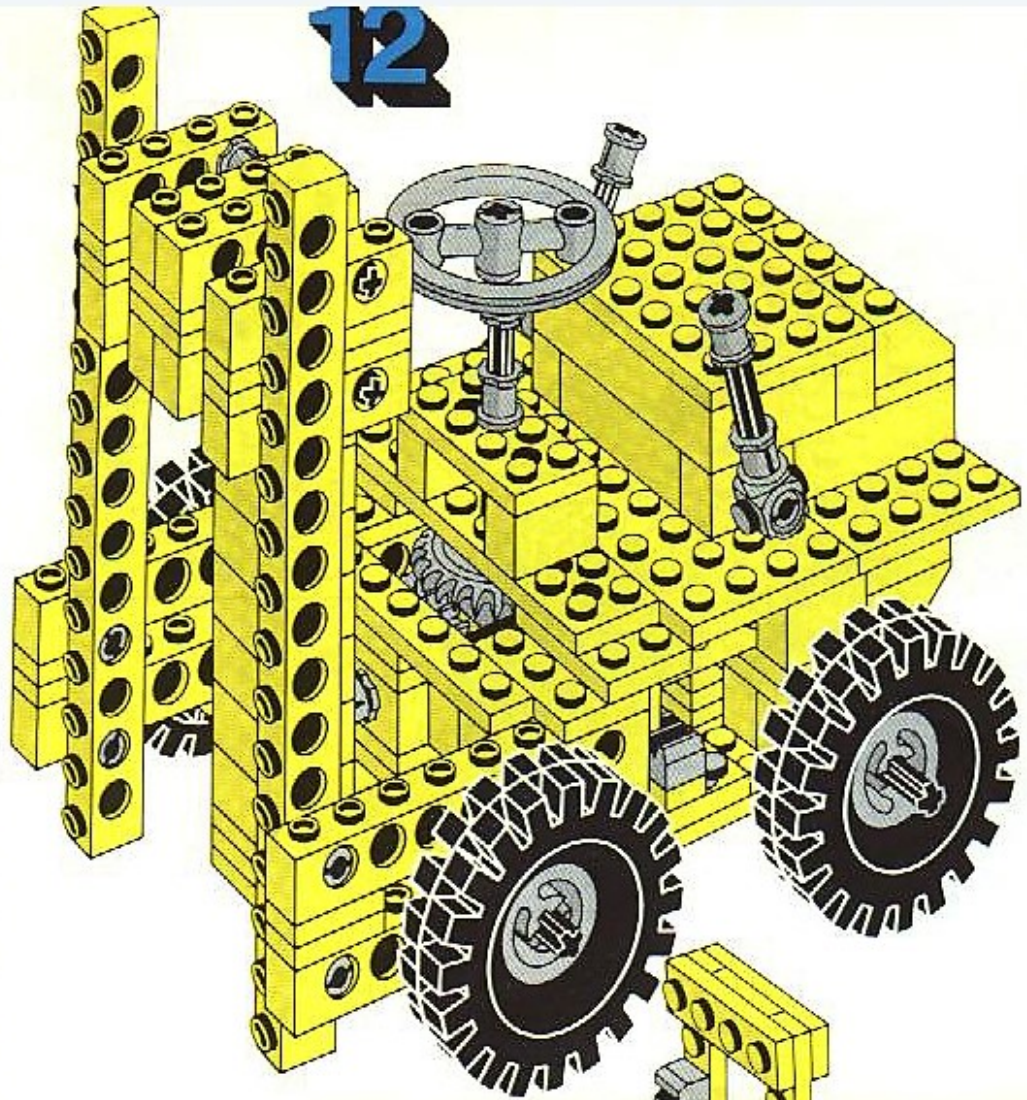

13

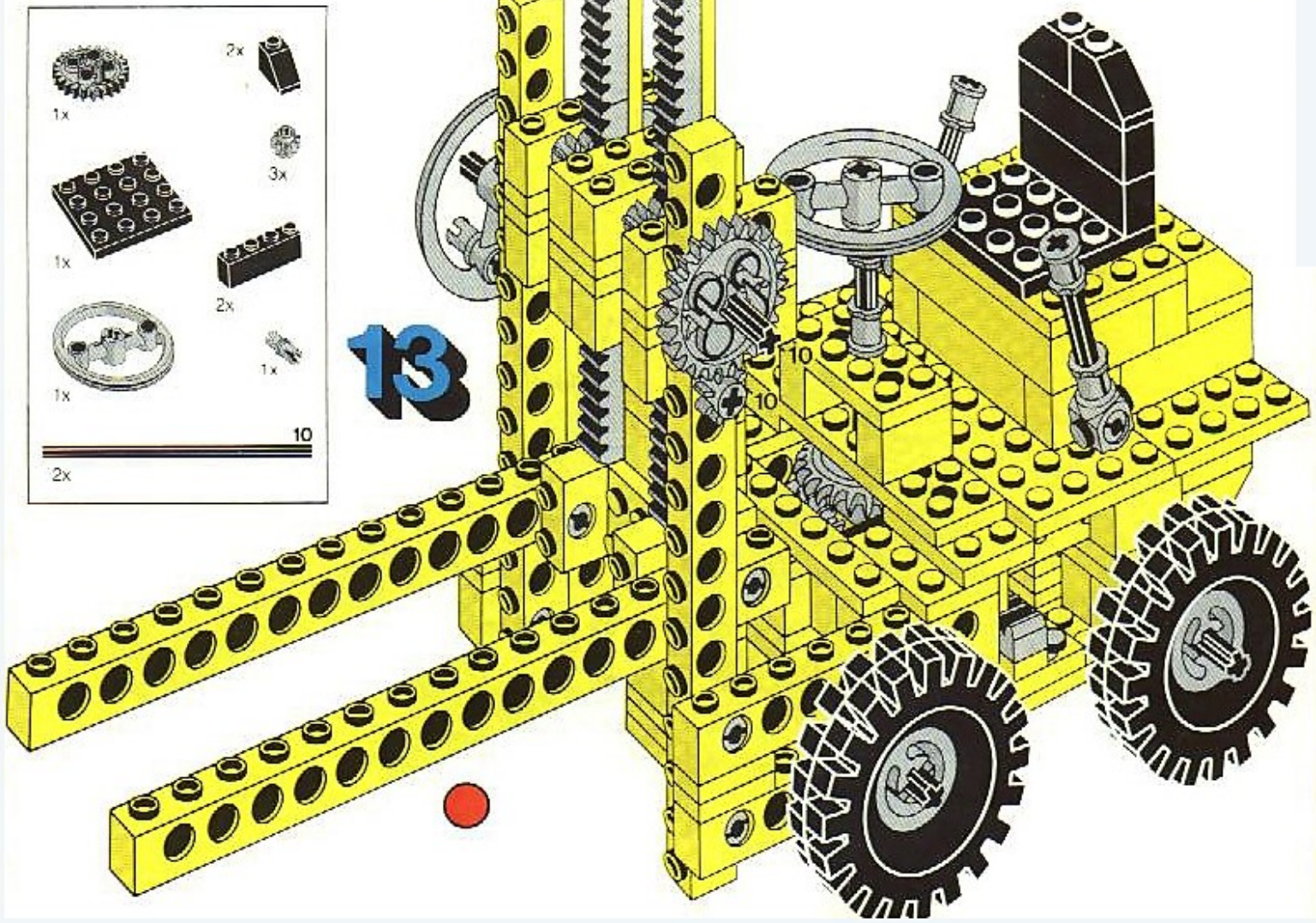

850

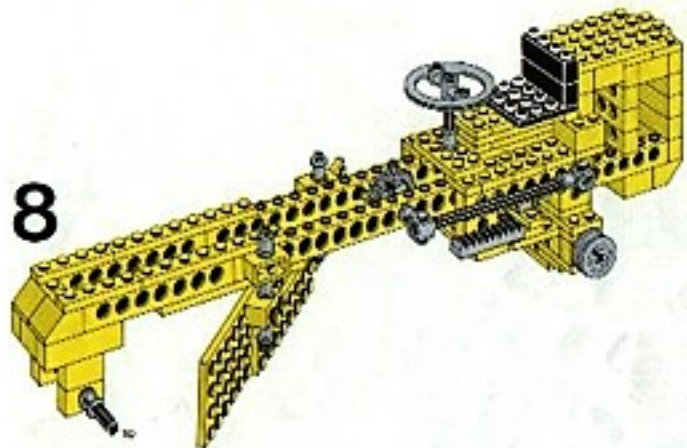
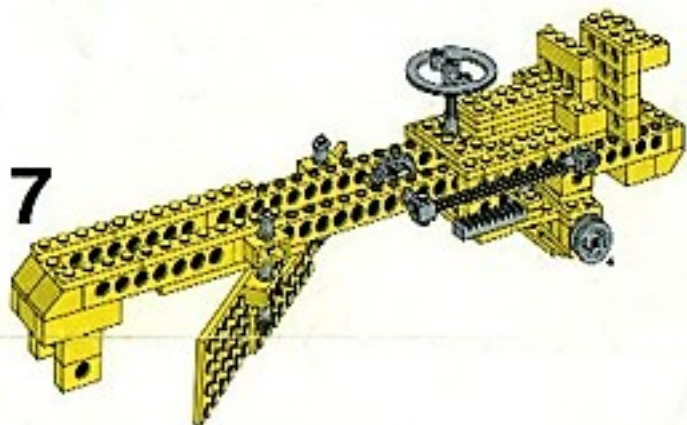
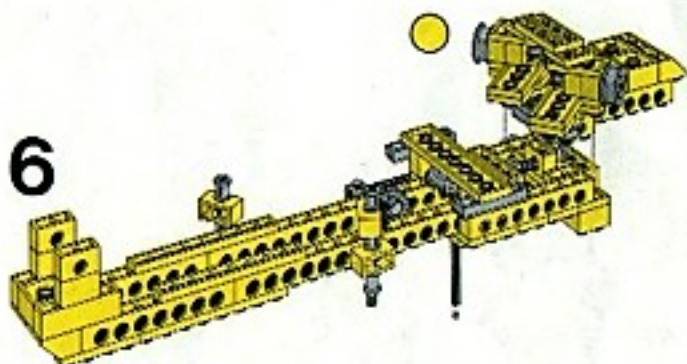
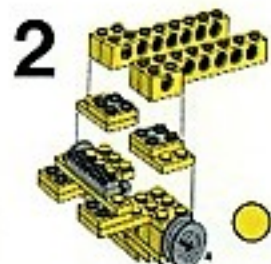
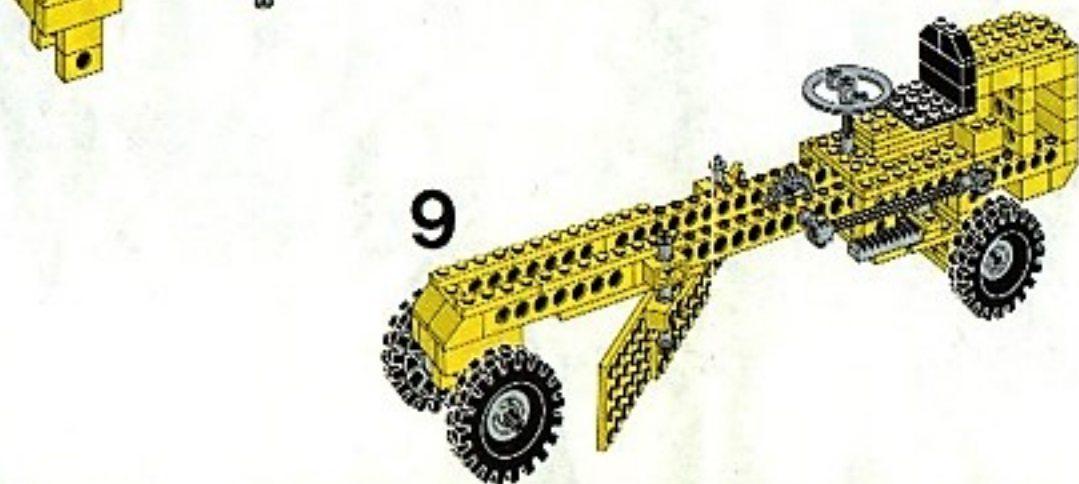
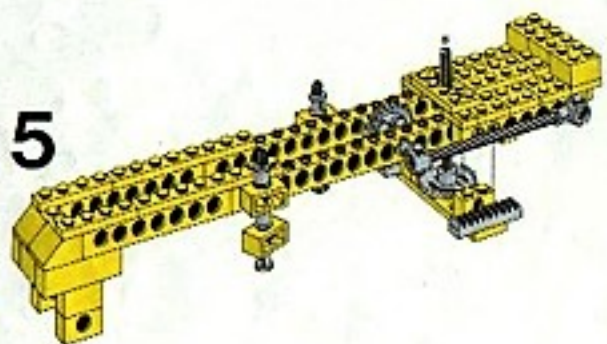
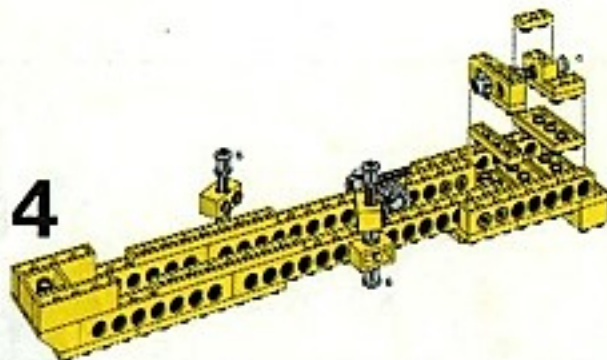
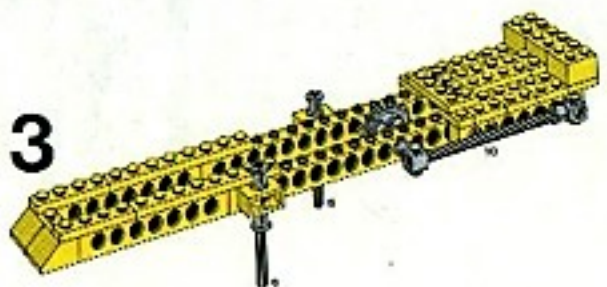
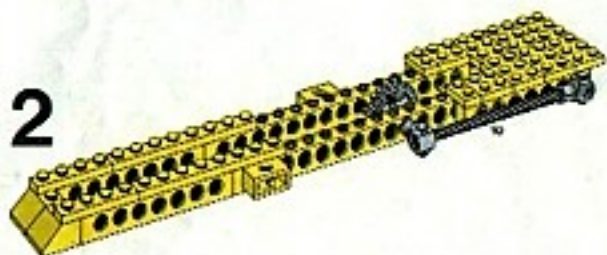
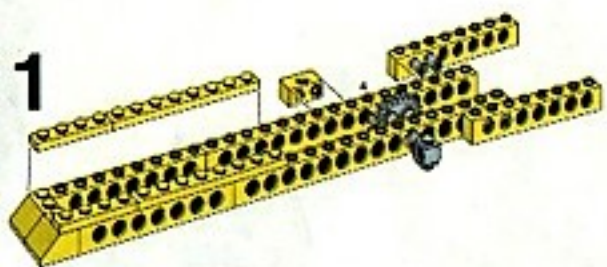

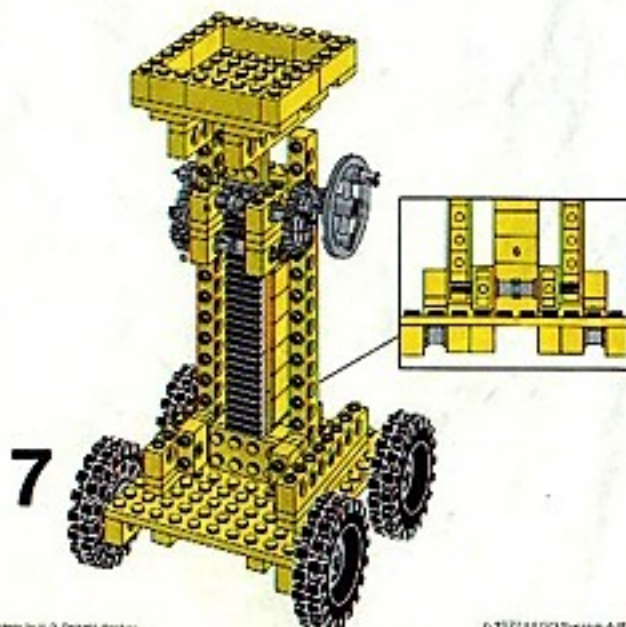
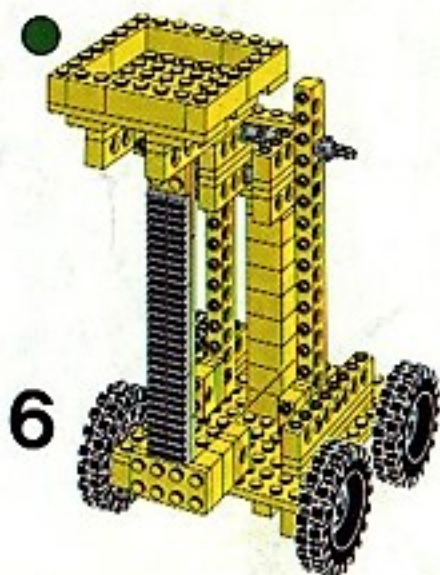
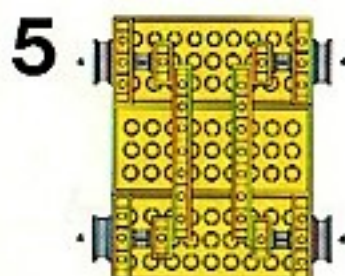
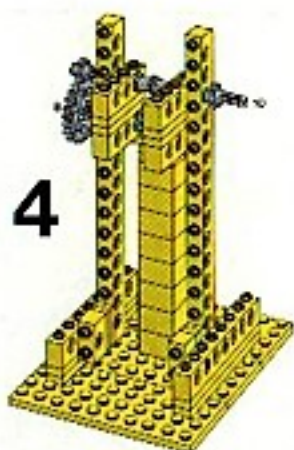
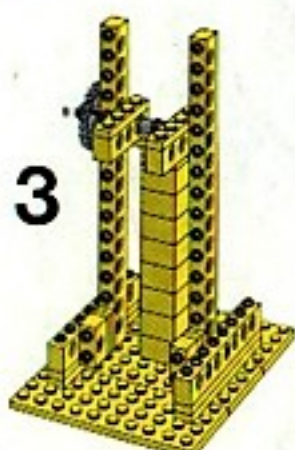
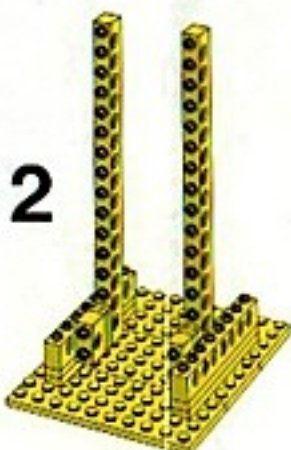
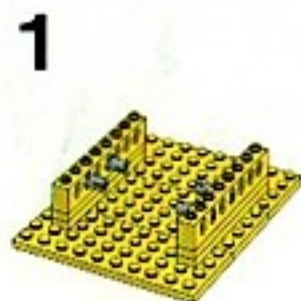
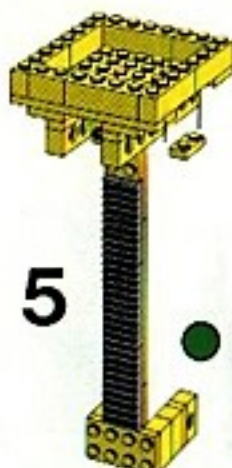
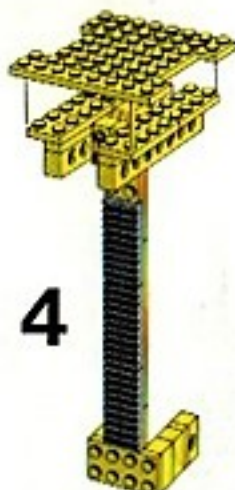
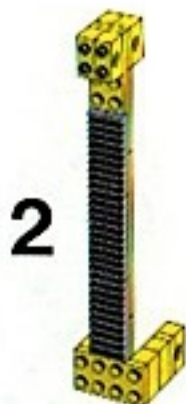
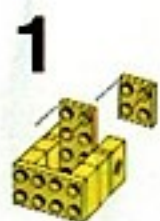

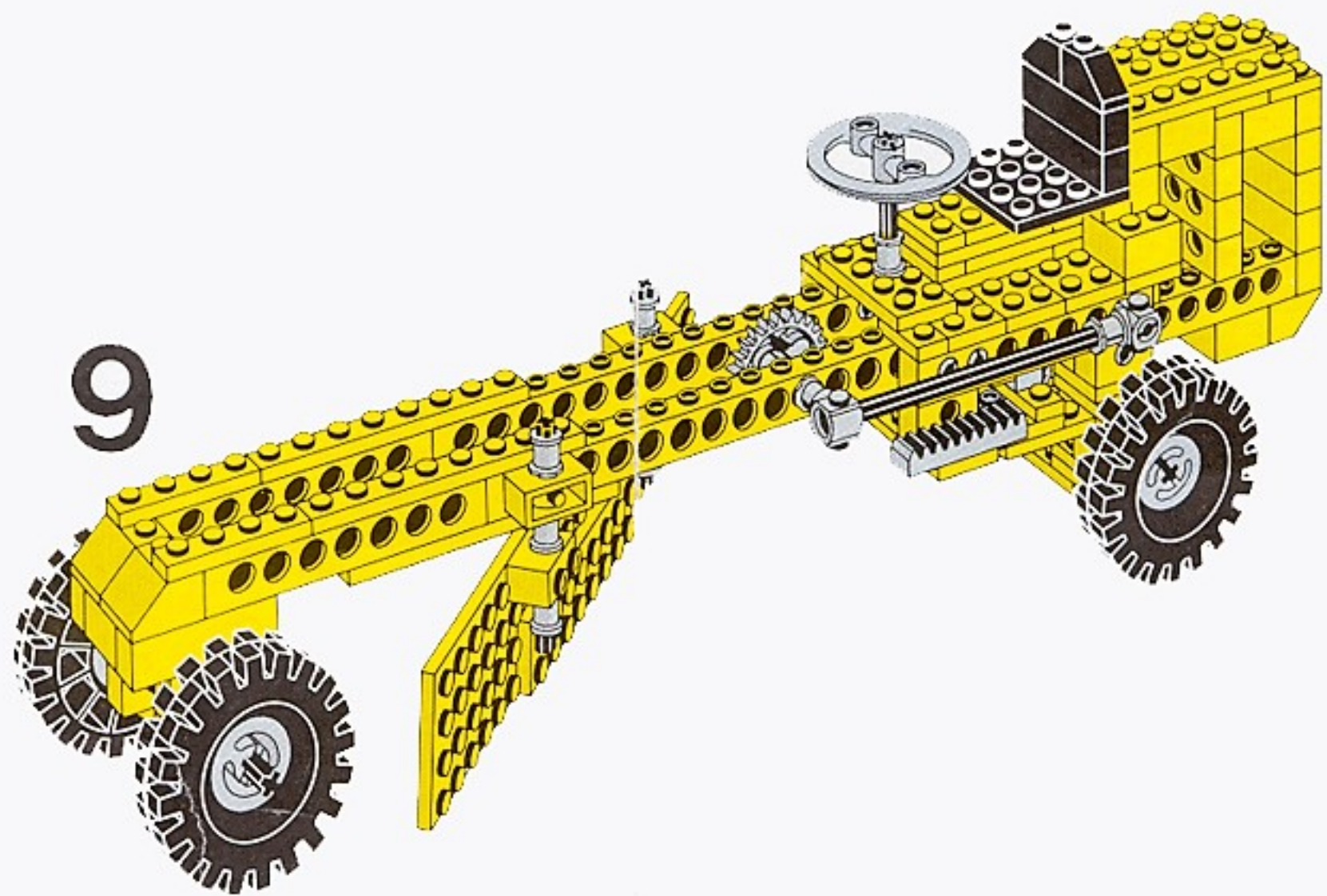





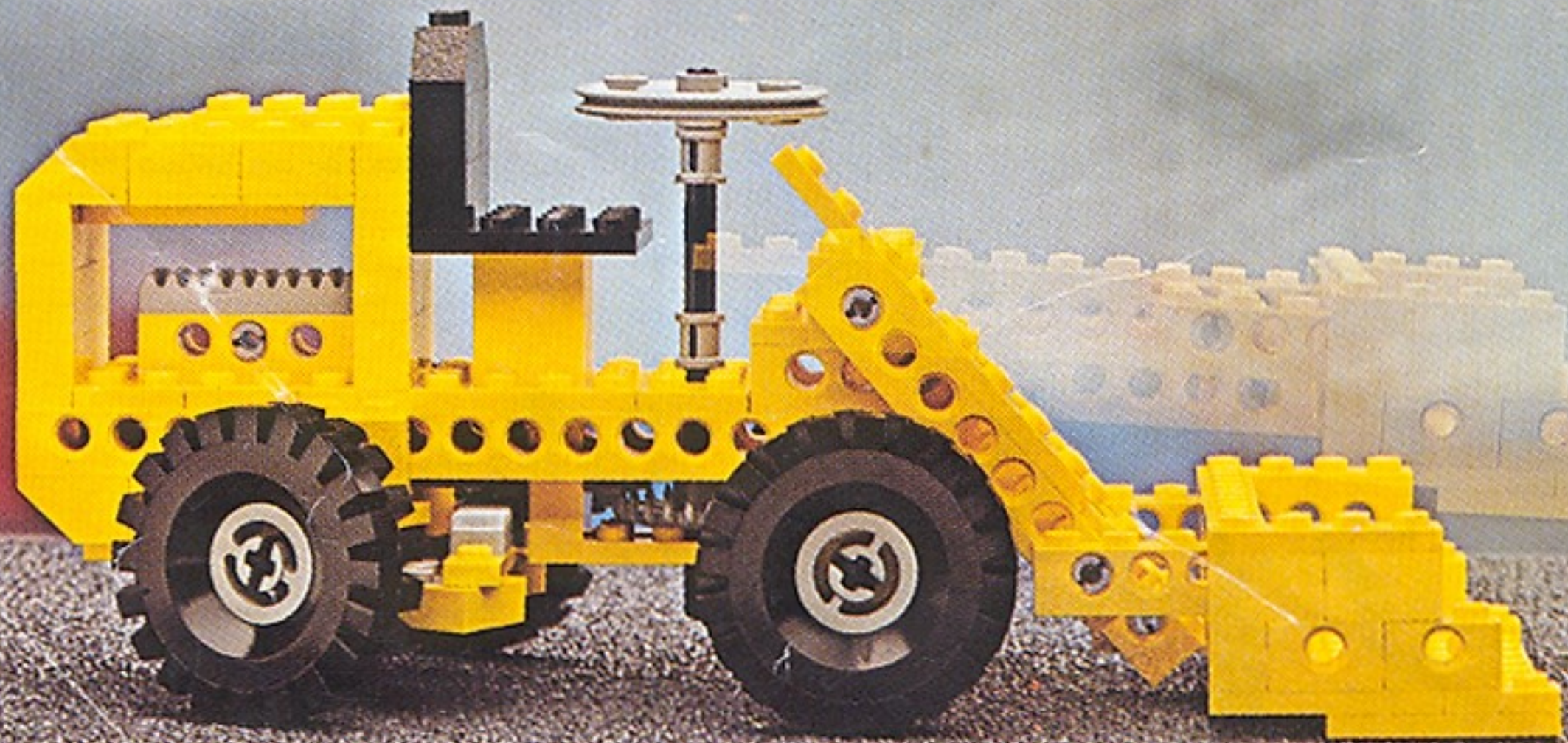



"In der Bauanleitung steht vor den Achsen eine Zahl, die die benötigte Länge der Achsen anzeigt."

"Numbers in the building instructions near axes show the length of axle to be used."

"Dans les conseils de construction, il y a un chiffre à côté de chaque axe. Ce chiffre indique la longueur des axes à utiliser."

"Ut for akslerne i byggeanvisningen er anført et tal som viser hvilken aksellængde som skal bruges."

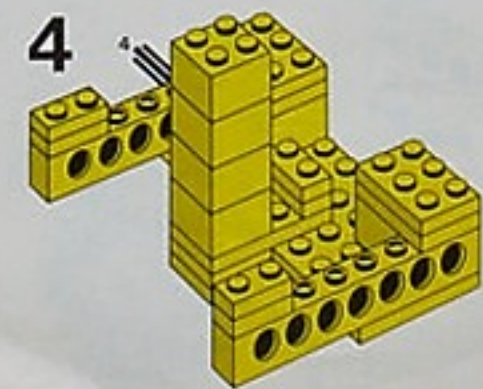
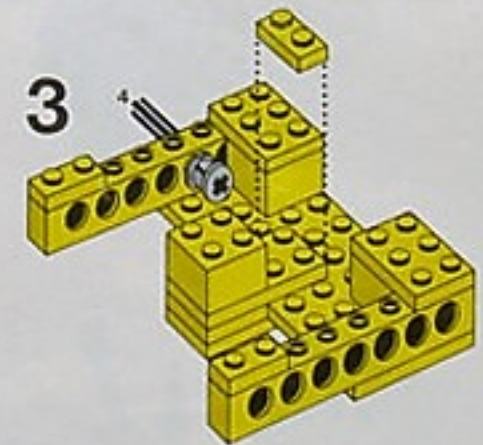
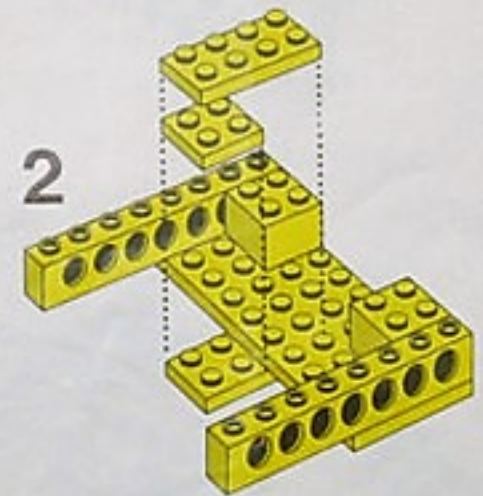
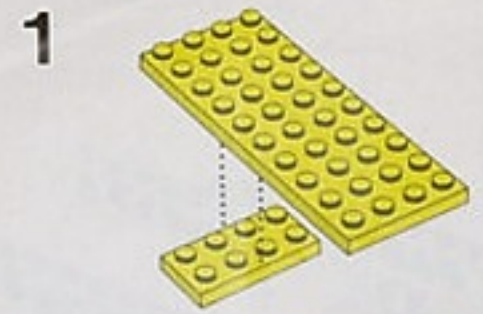
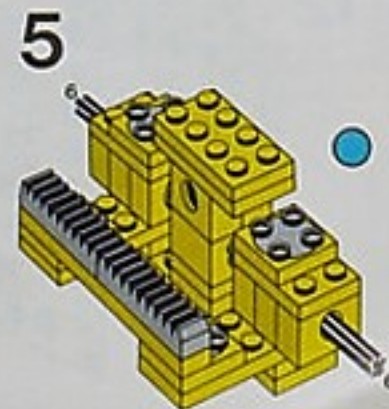
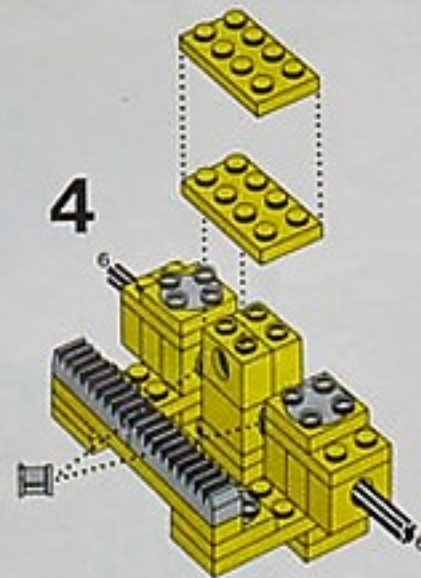
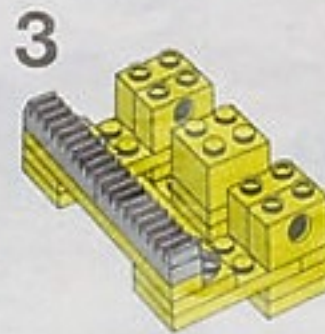
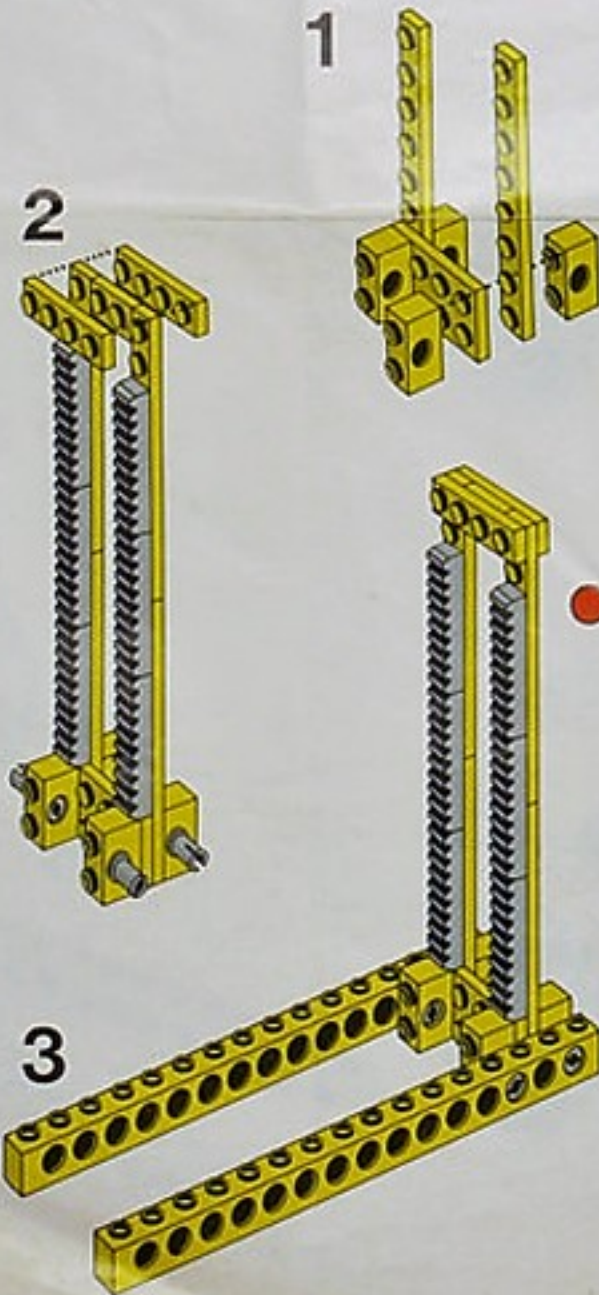
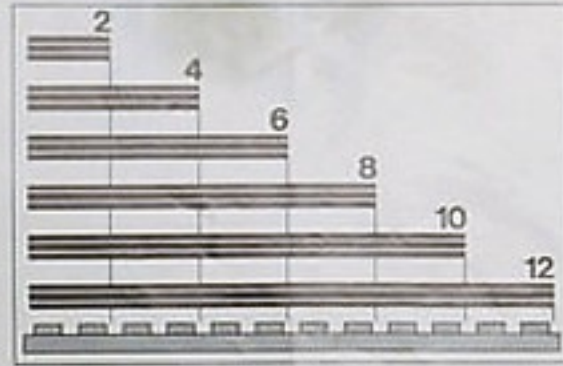

5

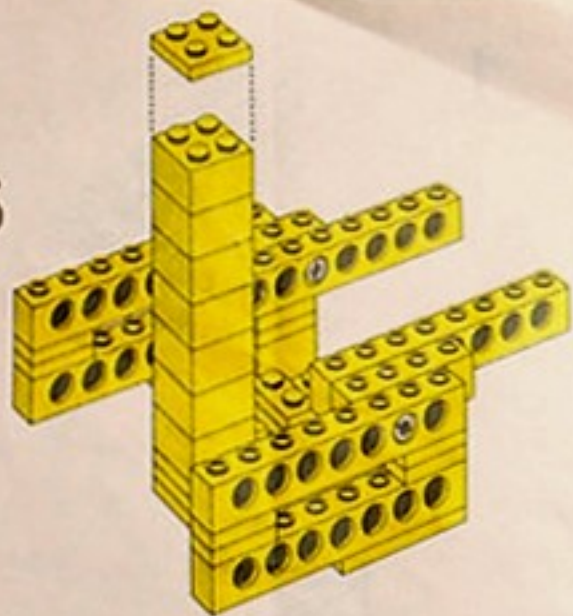

6

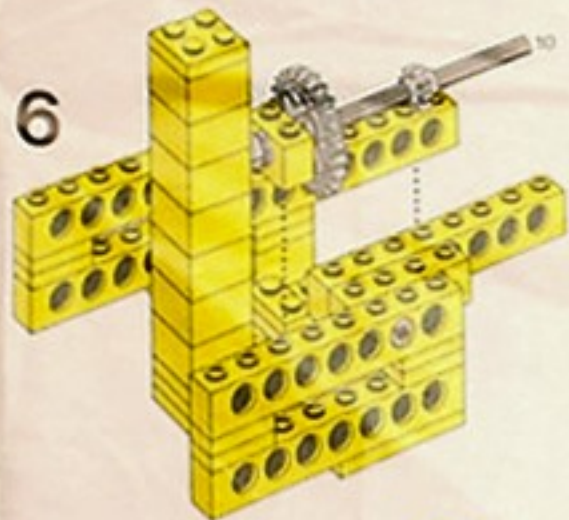

7

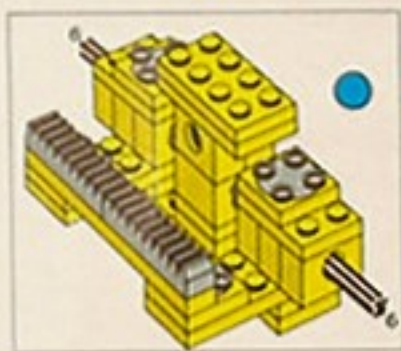
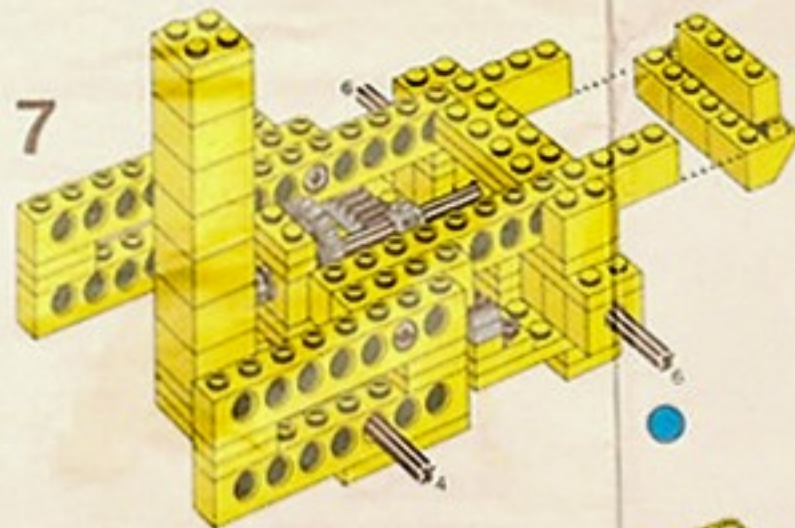

8

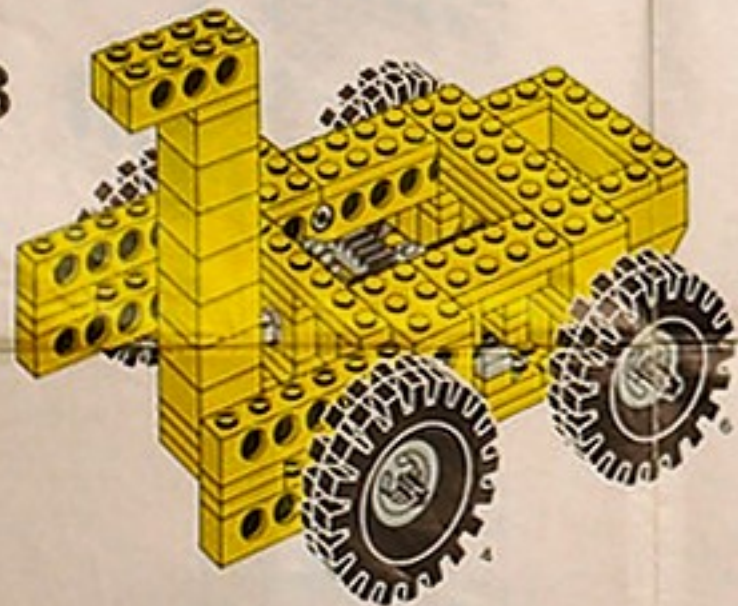

9

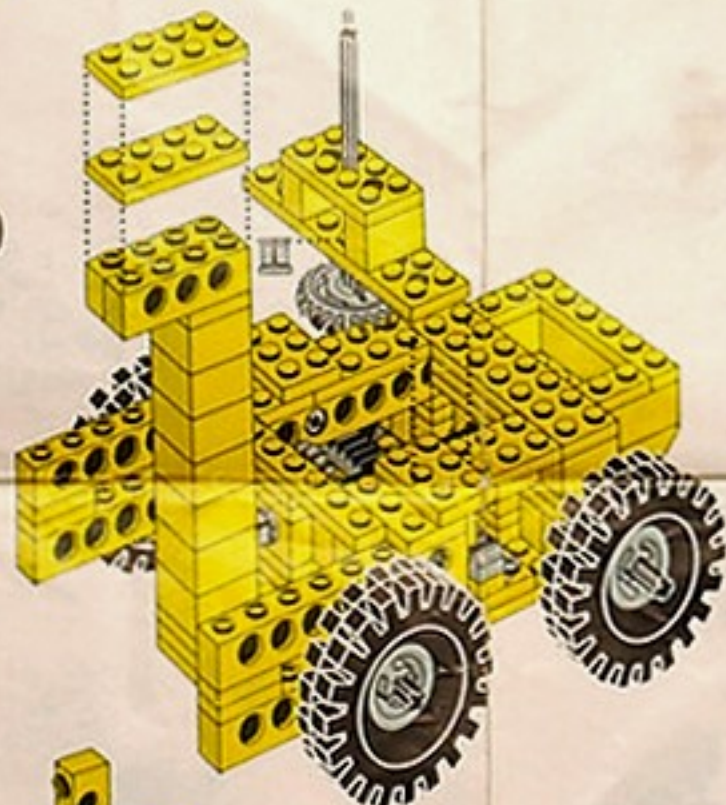

10

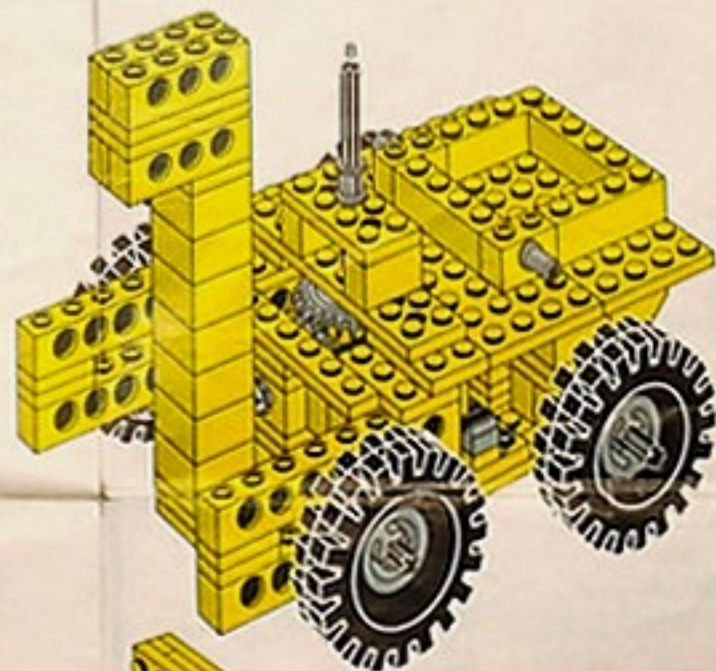

11

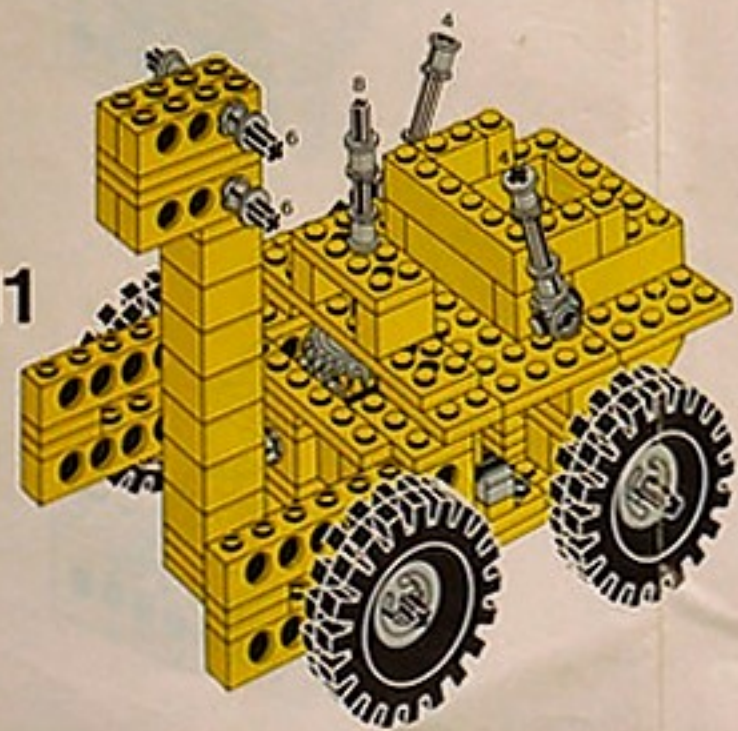

12

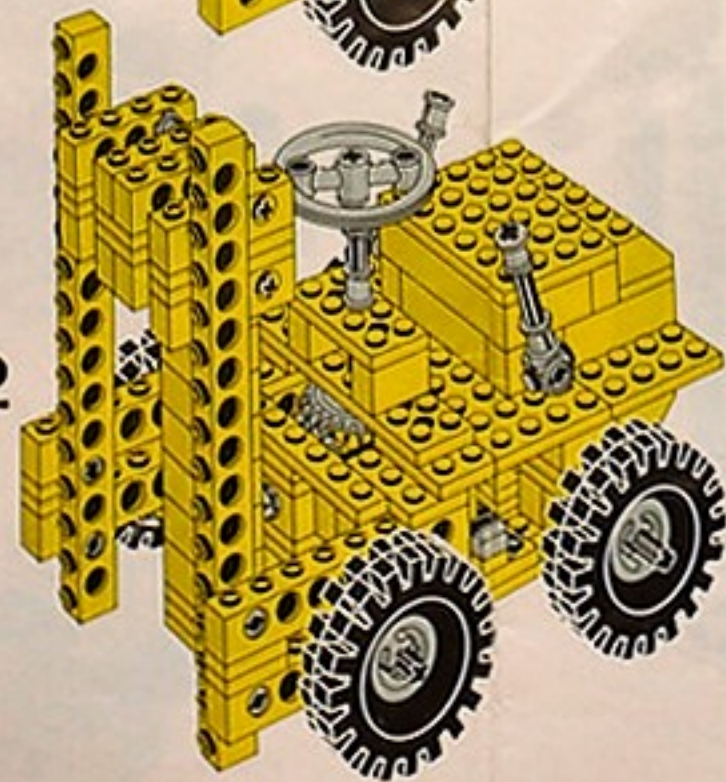

13

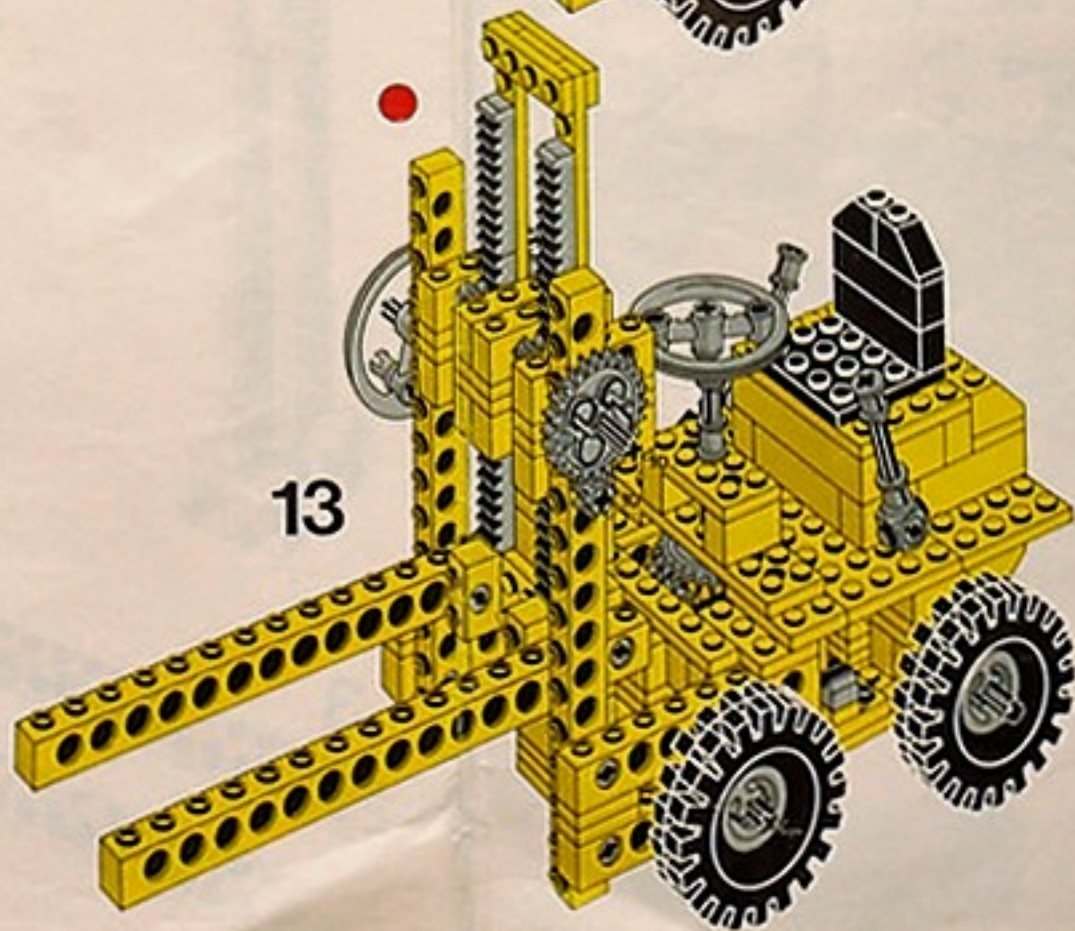

850

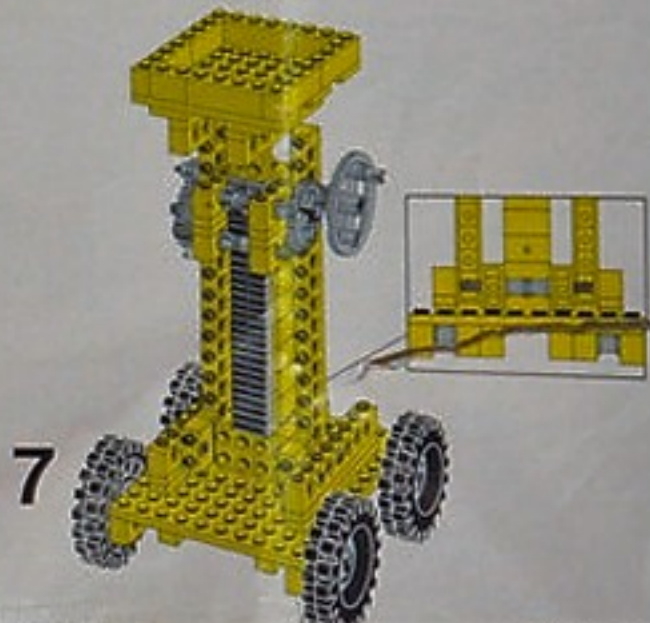
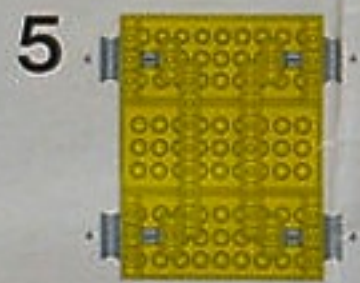
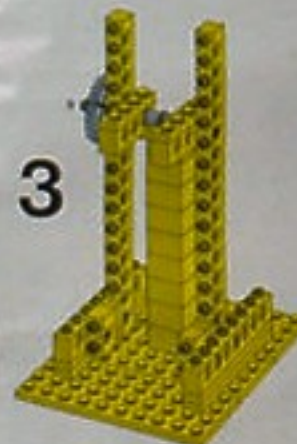
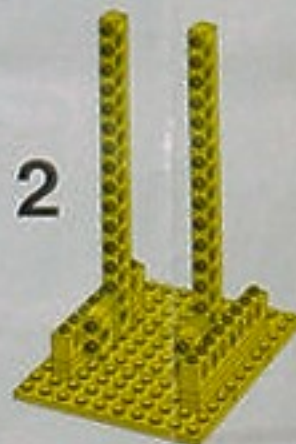
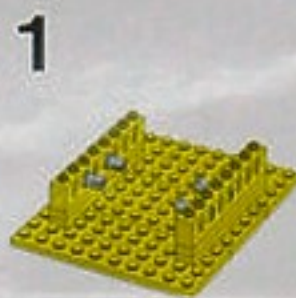
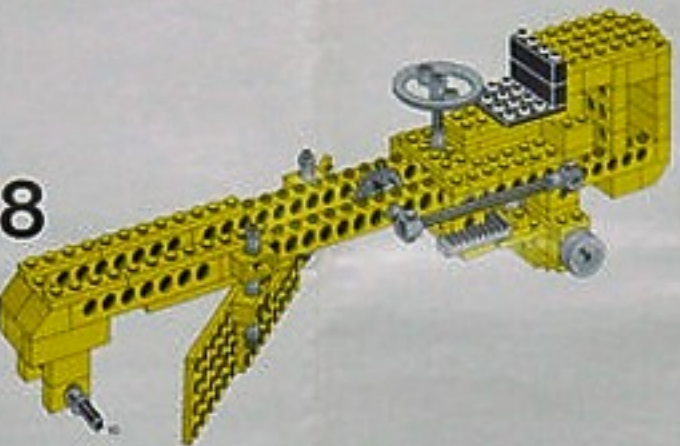
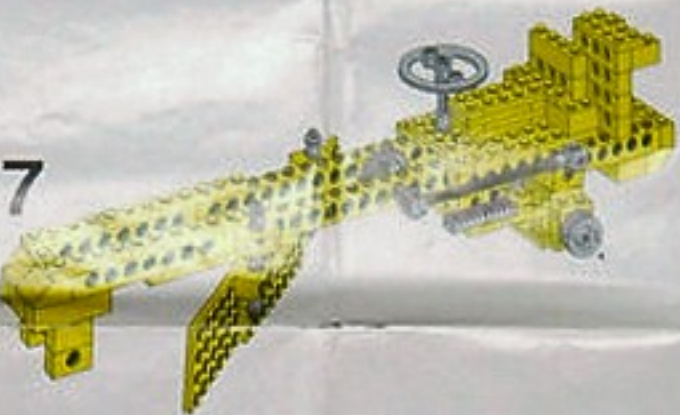
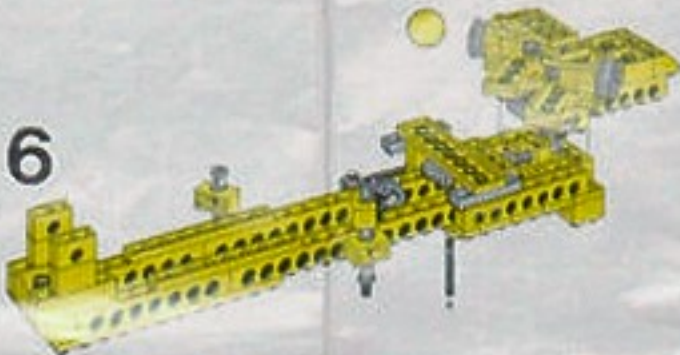
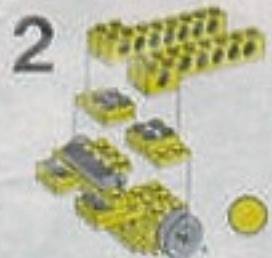
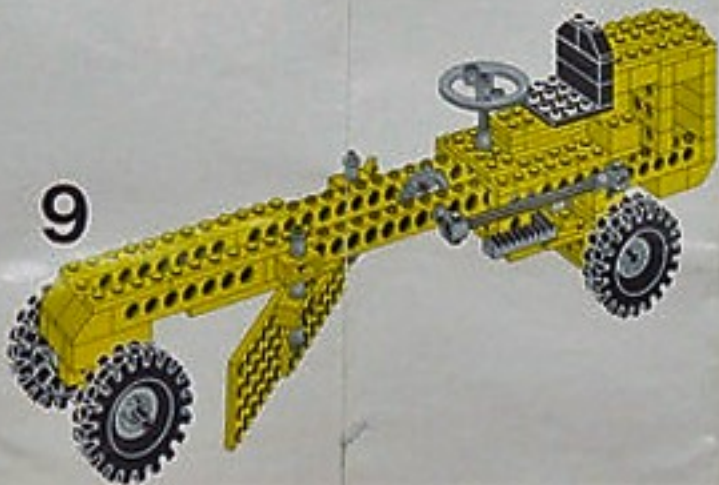
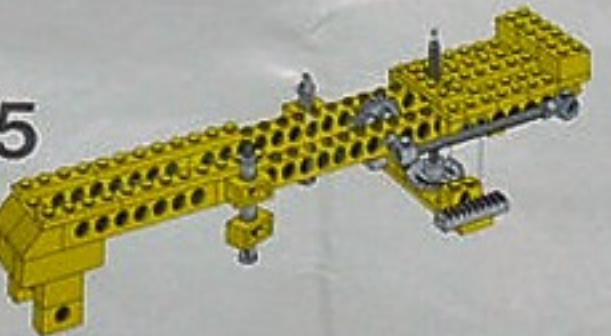
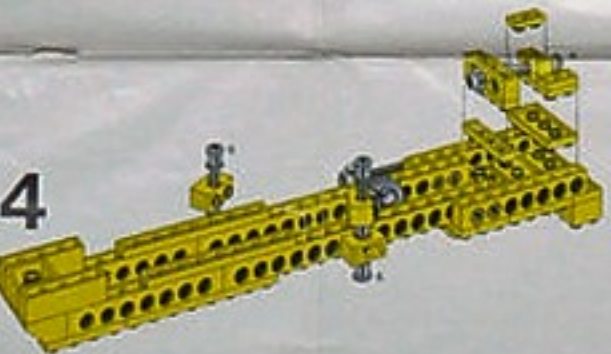

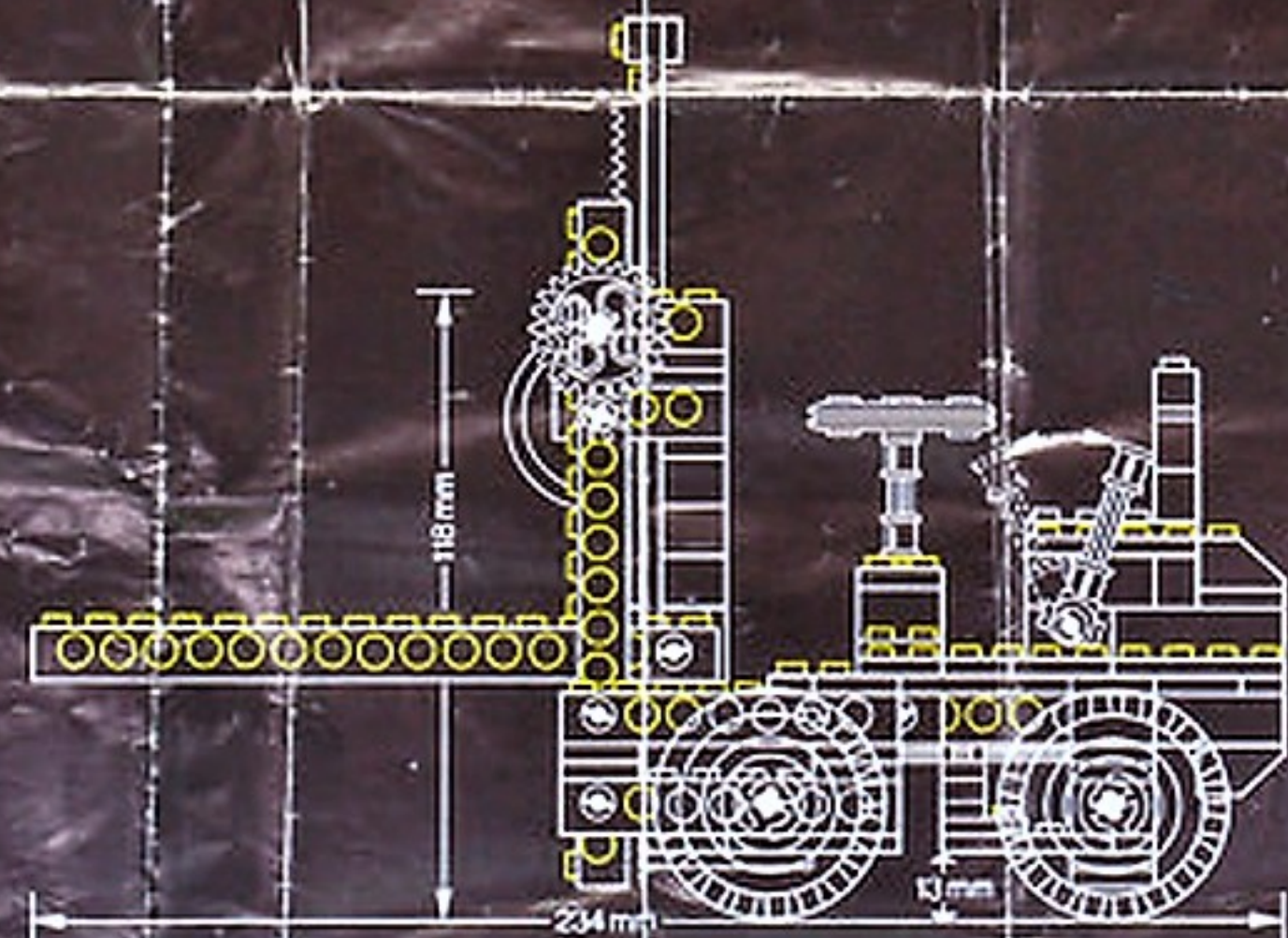
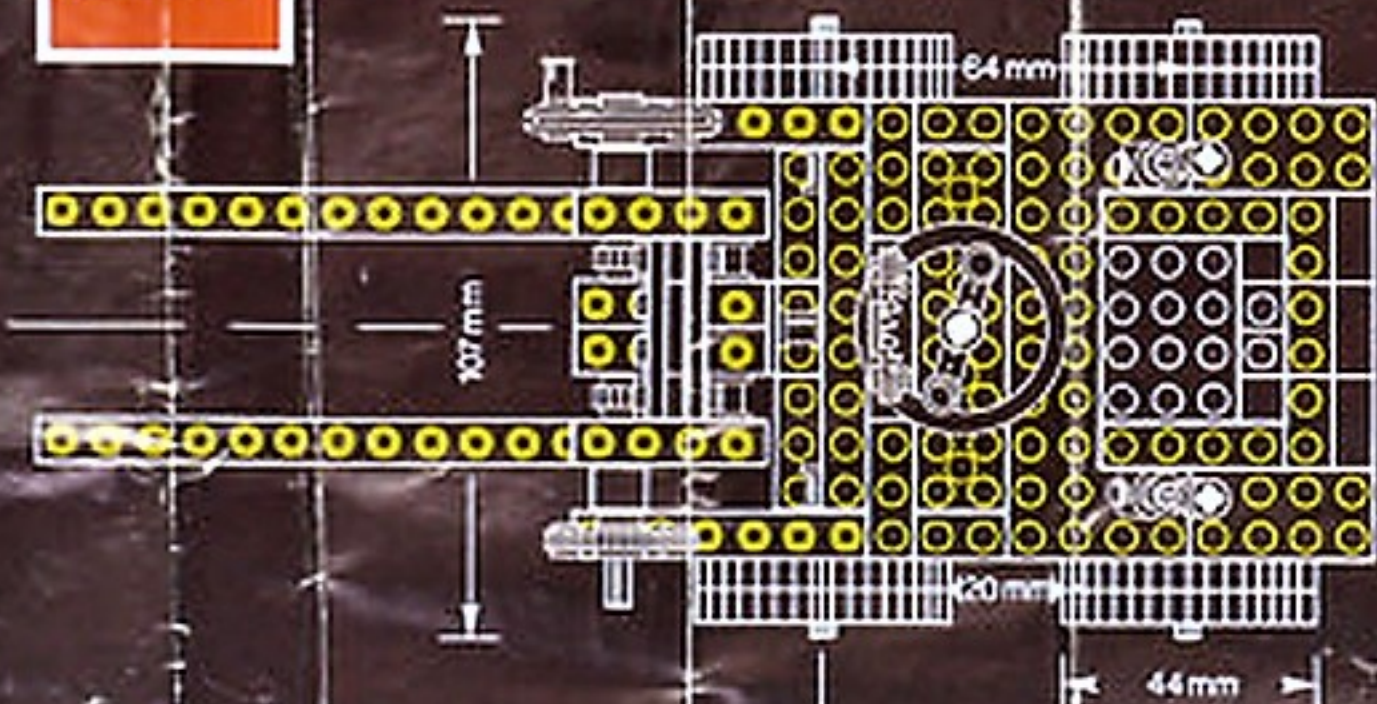

















Image	Qty	Item No	Description	MID
Regular Items:				
Parts:				
 *	2	3010	Black Brick 1 x 4 Catalog: Parts: Brick	PG
 *	1	3031	Black Plate 4 x 4 Catalog: Parts: Plate	PG
 *	2	3040a	Black Slope 45 2 x 1 - without Bottom Tube Catalog: Parts: Slope	PG
 *	4	3705	Black Technic, Axle 4 Catalog: Parts: Technic, Axle	PG
 *	4	3706	Black Technic, Axle 6 Catalog: Parts: Technic, Axle	PG
 *	1	3707	Black Technic, Axle 8 Catalog: Parts: Technic, Axle	PG
 *	3	3737	Black Technic, Axle 10 Catalog: Parts: Technic, Axle	PG
 *	4	3634	Black Tire 17 x 43 Catalog: Parts: Tire & Tread	PG
 *	14	3713	Light Gray Technic Bush Catalog: Parts: Technic	PG
 *	2	3651	Light Gray Technic, Axle and Pin Connector Catalog: Parts: Technic, Connector	PG
 *	4	3647	Light Gray Technic, Gear 8 Tooth Type 1 Catalog: Parts: Technic, Gear	PG

+	 *	2	x187	Light Gray Technic, Gear 24 Tooth (1st Version - 3 Axle Holes) Catalog: Parts: Technic, Gear	PG
---	---	---	----------------------	--	--------------------

+	 *	1	3650a	Light Gray Technic, Gear 24 Tooth Crown (1st Version - Not Reinforced) Catalog: Parts: Technic, Gear	PG 1
---	--	---	-----------------------	--	--

+	 *	8	3743	Light Gray Technic, Gear Rack 1 x 4 Catalog: Parts: Technic, Gear	PG
---	--	---	----------------------	---	--------------------

+	 *	15	3673	Light Gray Technic, Pin without Friction Ridges Lengthwise Catalog: Parts: Technic, Pin	PG
---	--	----	----------------------	---	--------------------

+	 *	2	3736	Light Gray Technic, Steering Pulley Large Catalog: Parts: Technic, Steering	PG
---	--	---	----------------------	---	--------------------

+	 *	4	3482	Light Gray Wheel with Split Axle Hole Catalog: Parts: Wheel	PG
---	---	---	----------------------	---	--------------------

+	 *	2	3005	Yellow Brick 1 x 1 Catalog: Parts: Brick	PG
---	--	---	----------------------	--	--------------------















+	 *	6	3004	Yellow Brick 1 x 2 Catalog: Parts: Brick	PG
---	--	---	----------------------	--	--------------------

+	 *	7	3010	Yellow Brick 1 x 4 Catalog: Parts: Brick	PG
---	--	---	----------------------	--	--------------------

+	 *	1	3009	Yellow Brick 1 x 6 Catalog: Parts: Brick	PG
---	--	---	----------------------	--	--------------------

+	 *	10	3003old	Yellow Brick 2 x 2 without Inside Supports Catalog: Parts: Brick	PG
---	--	----	-------------------------	--	--------------------

+	 *	13	3023	Yellow Plate 1 x 2 Catalog: Parts: Plate	PG
---	--	----	----------------------	--	--------------------

+		6	3710	Yellow Plate 1 x 4 Catalog : Parts : Plate	PG	2	
+		1	3666	Yellow Plate 1 x 6 Catalog : Parts : Plate	PG		
+		6	3460	Yellow Plate 1 x 8 Catalog : Parts : Plate	PG		
+		4	3022	Yellow Plate 2 x 2 Catalog : Parts : Plate	PG		
+		12	3021	Yellow Plate 2 x 3 Catalog : Parts : Plate	PG		
+		11	3020	Yellow Plate 2 x 4 Catalog : Parts : Plate	PG		
+		2	3034	Yellow Plate 2 x 8 Catalog : Parts : Plate	PG	2	
+		1	3032	Yellow Plate 4 x 6 Catalog : Parts : Plate	PG		
+		3	3030	Yellow Plate 4 x 10 Catalog : Parts : Plate	PG		
+		3	3039	Yellow Slope 45 2 x 2 Catalog : Parts : Slope	PG		
+		3	3660	Yellow Slope, Inverted 45 2 x 2 Catalog : Parts : Slope , Inverted	PG		
+		15	3700	Yellow Technic, Brick 1 x 2 with Hole Catalog : Parts : Technic , Brick	PG		

+  10 [3701](#) **Yellow Technic, Brick 1 x 4 with Holes** [PG](#)
[Catalog:](#) [Parts:](#) [Technic, Brick](#)

+  6 [3702](#) **Yellow Technic, Brick 1 x 8 with Holes** [PG](#)
[Catalog:](#) [Parts:](#) [Technic, Brick](#)

+  4 [3703](#) **Yellow Technic, Brick 1 x 16 with Holes** [PG](#)
[Catalog:](#) [Parts:](#) [Technic, Brick](#)

+  1 [3709b](#) **Yellow Technic, Plate 2 x 4 with 3 Holes** [PG](#)
[Catalog:](#) [Parts:](#) [Technic, Plate](#)

+  1 [3738](#) **Yellow Technic, Plate 2 x 8 with 7 Holes** [PG](#)
[Catalog:](#) [Parts:](#) [Technic, Plate](#)

+  6 [3680c01\(inv\)](#) **Yellow Turntable 2 x 2 Plate, Base with Light Gray Turntable 2 x 2 Plate, Top (3680 / 3679)** [PG](#)
[Catalog:](#) [Parts:](#) [Turntable](#)

Extra Items:

+  1 [3737](#) **Black Technic, Axle 10** [PG](#)
[Catalog:](#) [Parts:](#) [Technic, Axle](#)

+  1 [3651](#) **Light Gray Technic, Axle and Pin Connector** [PG](#)
[Catalog:](#) [Parts:](#) [Technic, Connector](#)



+  1 [3647](#) **Light Gray Technic, Gear 8 Tooth Type 1** [PG](#)
[Catalog:](#) [Parts:](#) [Technic, Gear](#)

+  1 [3673](#) **Light Gray Technic, Pin without Friction Ridges Lengthwise** [PG](#)
[Catalog:](#) [Parts:](#) [Technic, Pin](#)

Counterparts:

+  4 [3482c03\(inv\)](#) **Light Gray Wheel with Split Axle Hole with Black Tire 17 x 43 (3482 / 3634)** [PG](#)
[Catalog:](#) [Parts:](#) [Wheel & Tire Assembly](#)

Alternate Items:

+	 *	1	3650a	Black Technic, Gear 24 Tooth Crown (1st Version - Not Reinforced) Catalog: Parts: Technic, Gear	PG	1	■
+	 *	7	3710	Yellow Plate 1 x 4 Catalog: Parts: Plate	PG	2	■
+	 *	4	3034	Yellow Plate 2 x 8 Catalog: Parts: Plate	PG	2	■

Note:



Redesigned during production.

There are at least 2 different versions of instructions for this set. The differences for the second version are indicated in this inventory in the Alternate Items section with Match ID 99.

Quick overview of redesign: Two 2 x 8 plates and one 1 x 4 plate are added underneath the seat platform to allow more clearance for the back tires.

Summary:

Type	Unique Lots	Total Qty
Regular Items:		
Parts	41	207
Extra Items:		
Parts	4	4
Counterparts:		
Parts	1	4
Alternative Items:		
Parts	3	12

[peloquin \(460\)](#)   inventoried this Set on Apr 21, 2003, inventory last updated on Apr 27, 2018.