

3

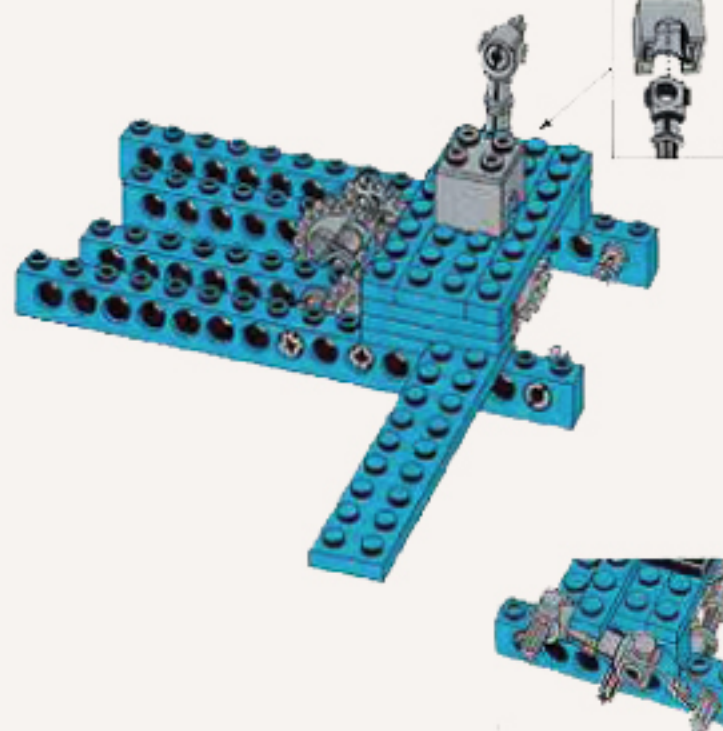

4

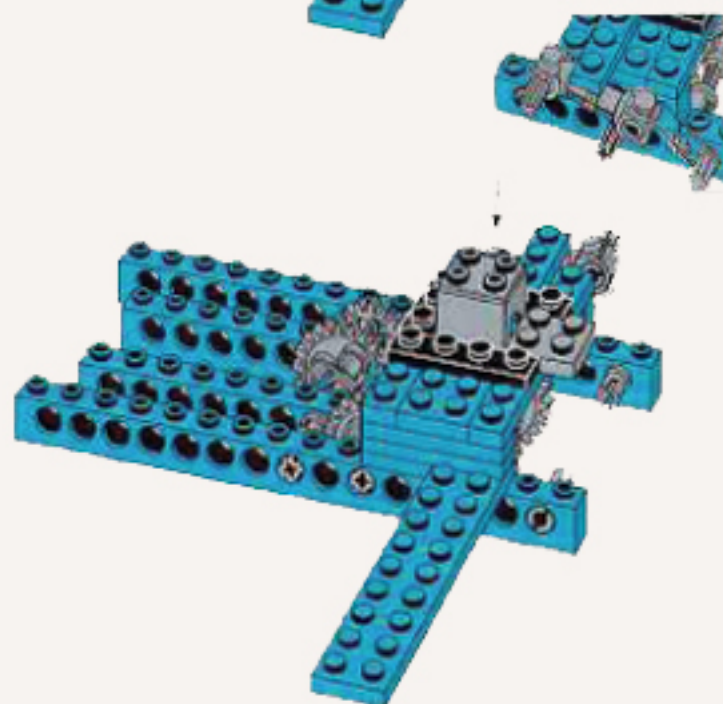

5

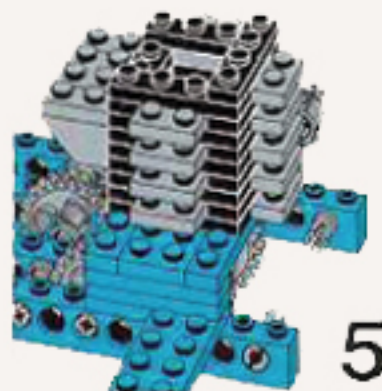
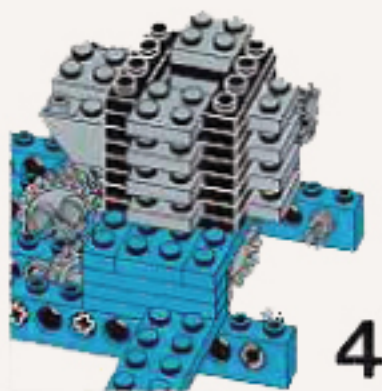
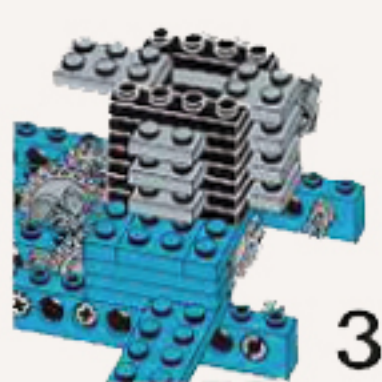
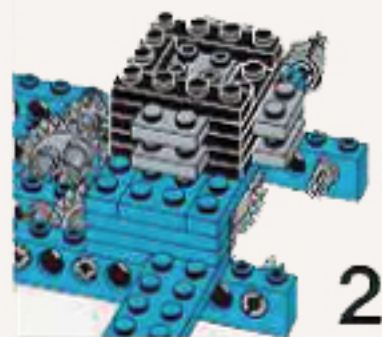
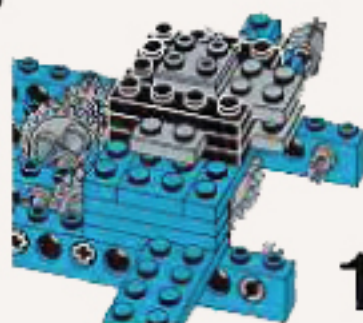

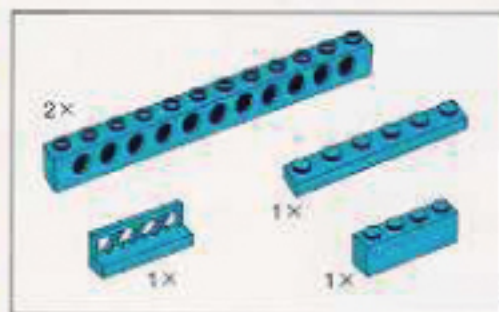

6

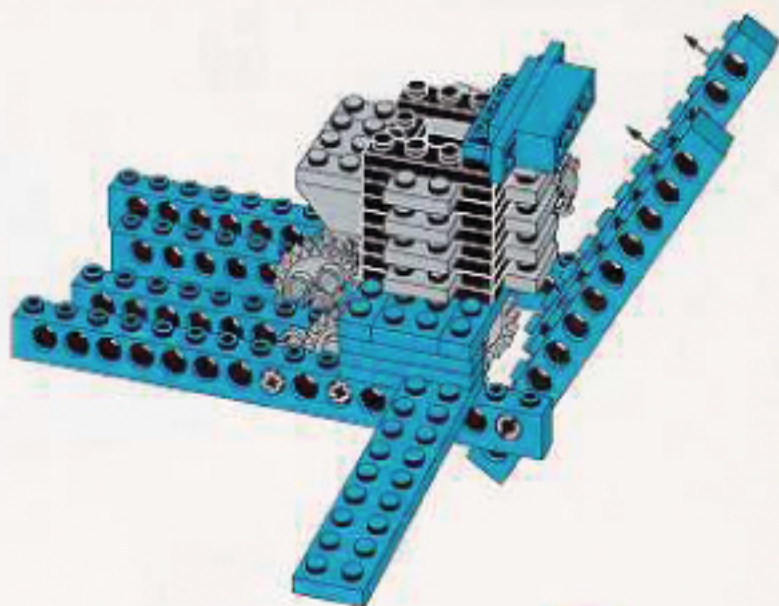

7

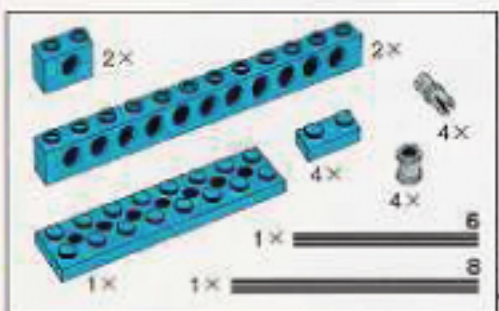
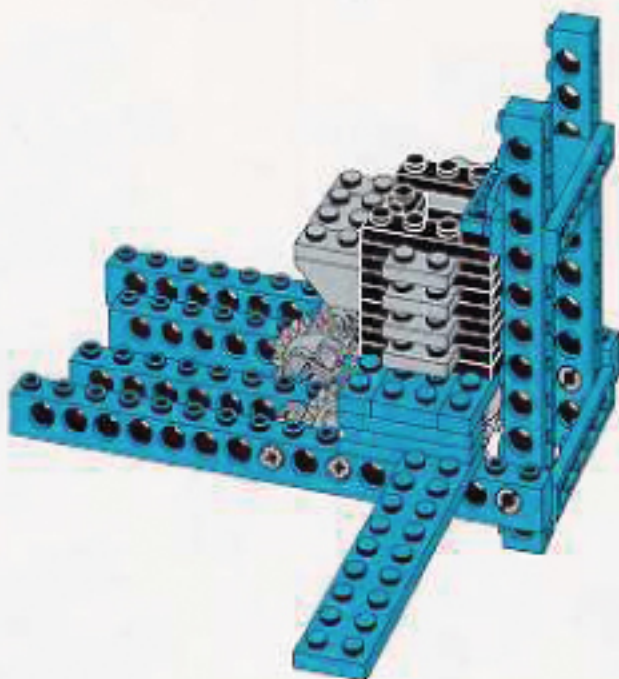

8

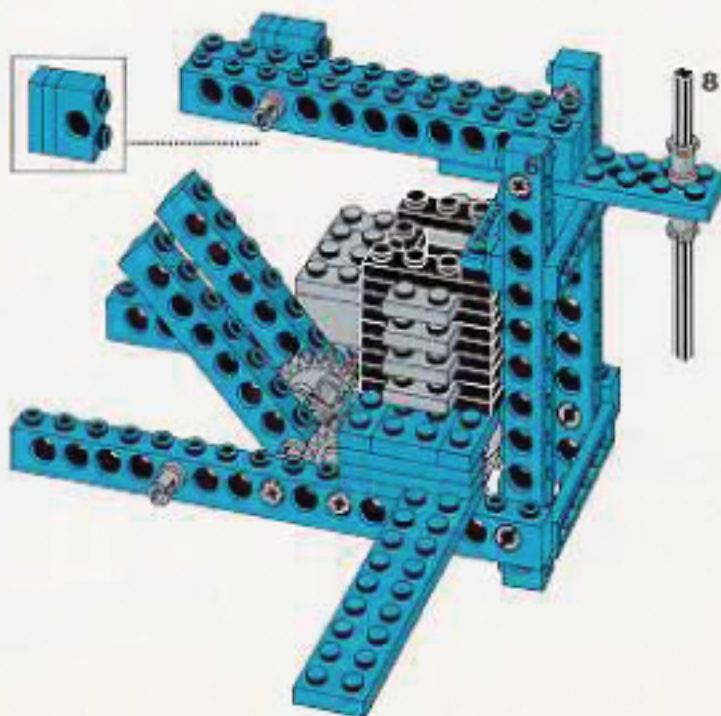

9

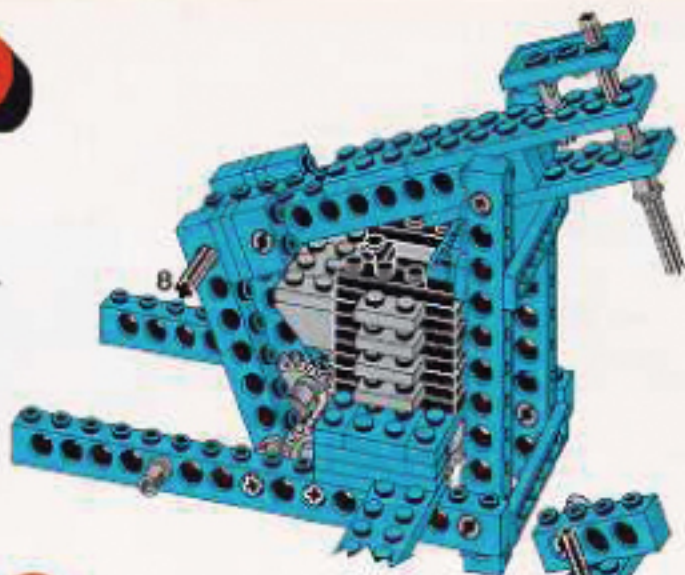
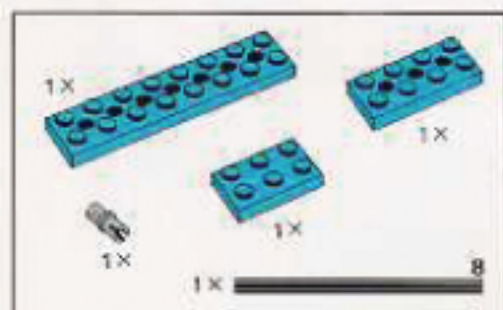

10

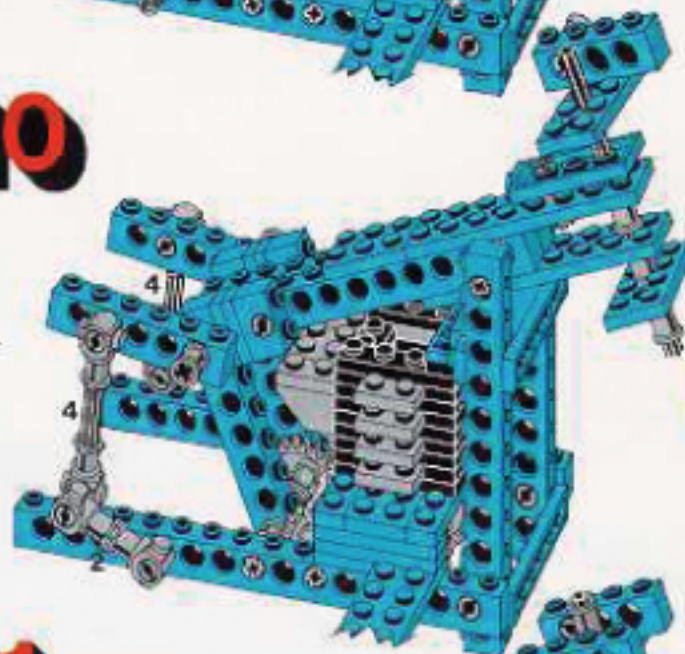
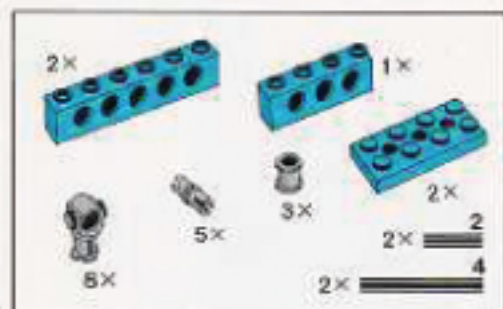

11

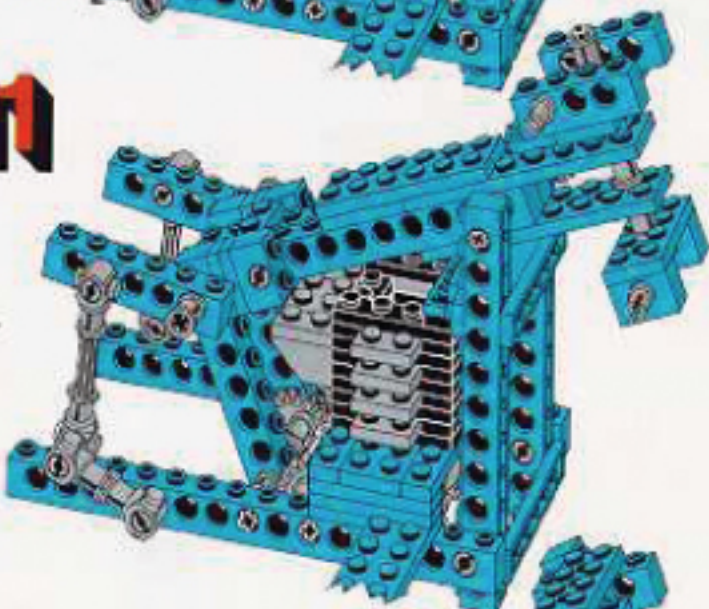
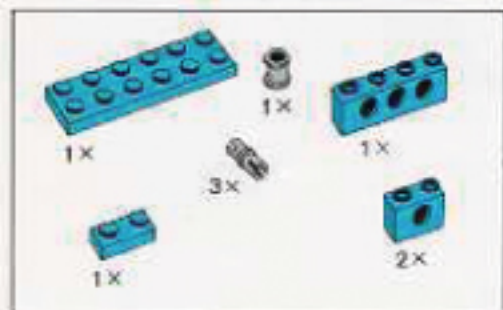

12

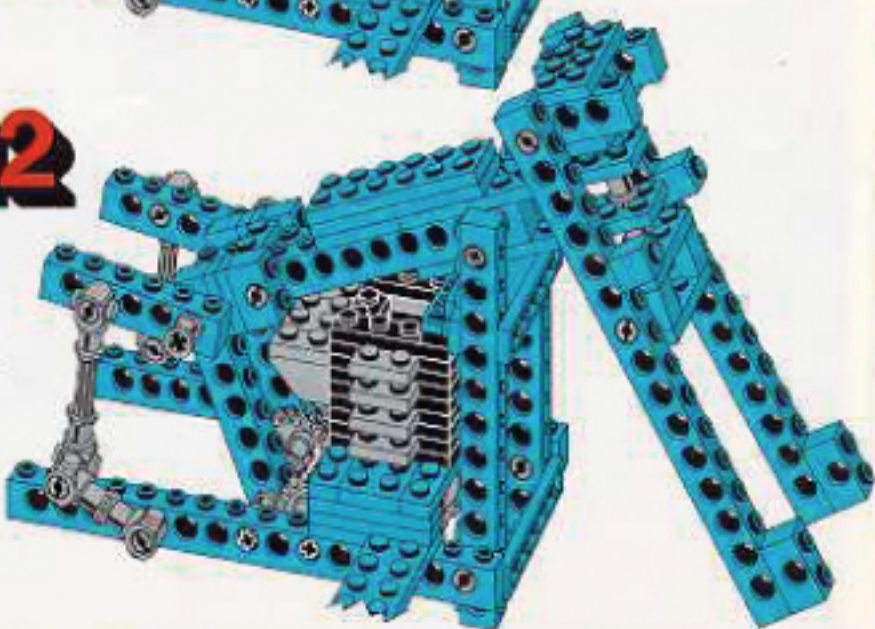
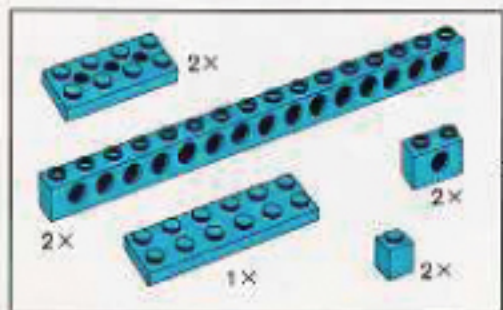

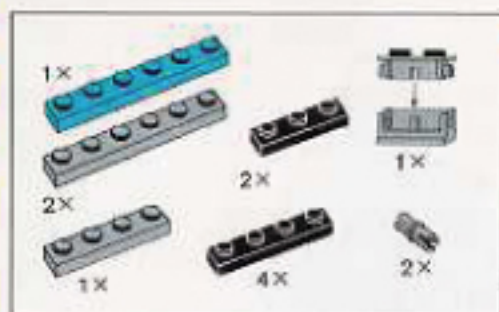

13

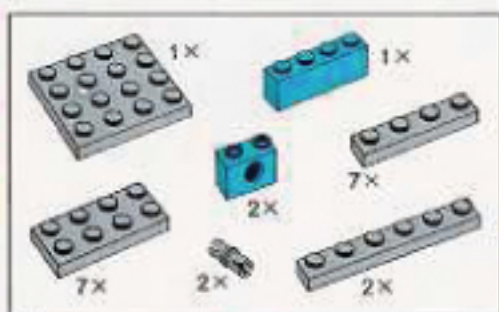
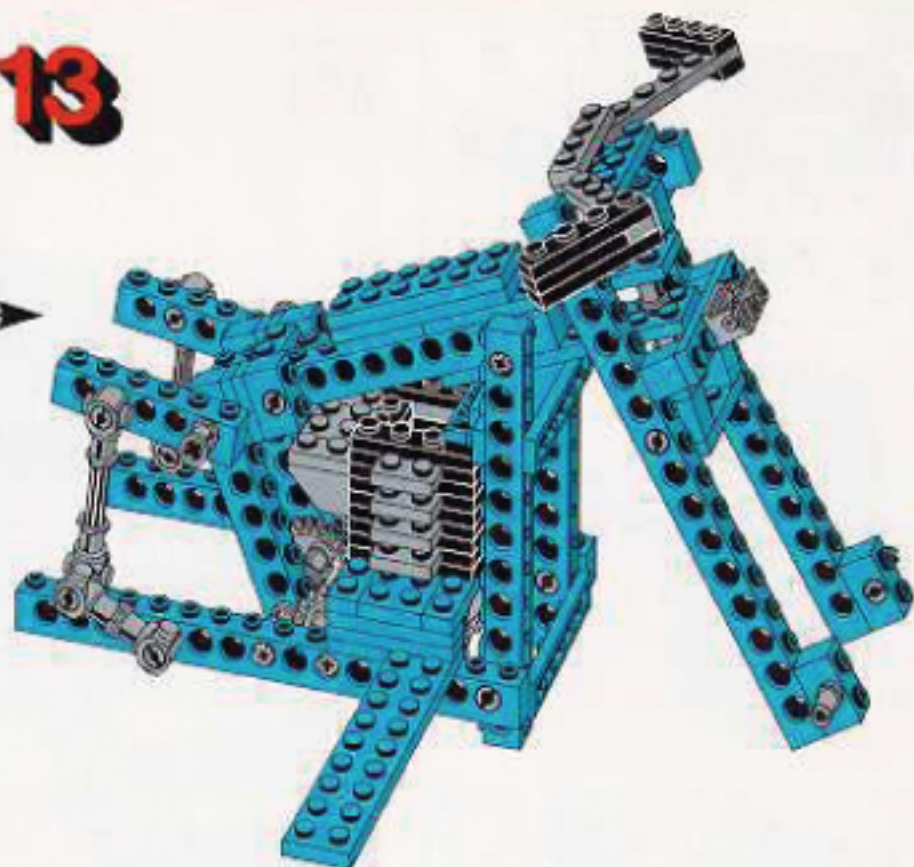

14

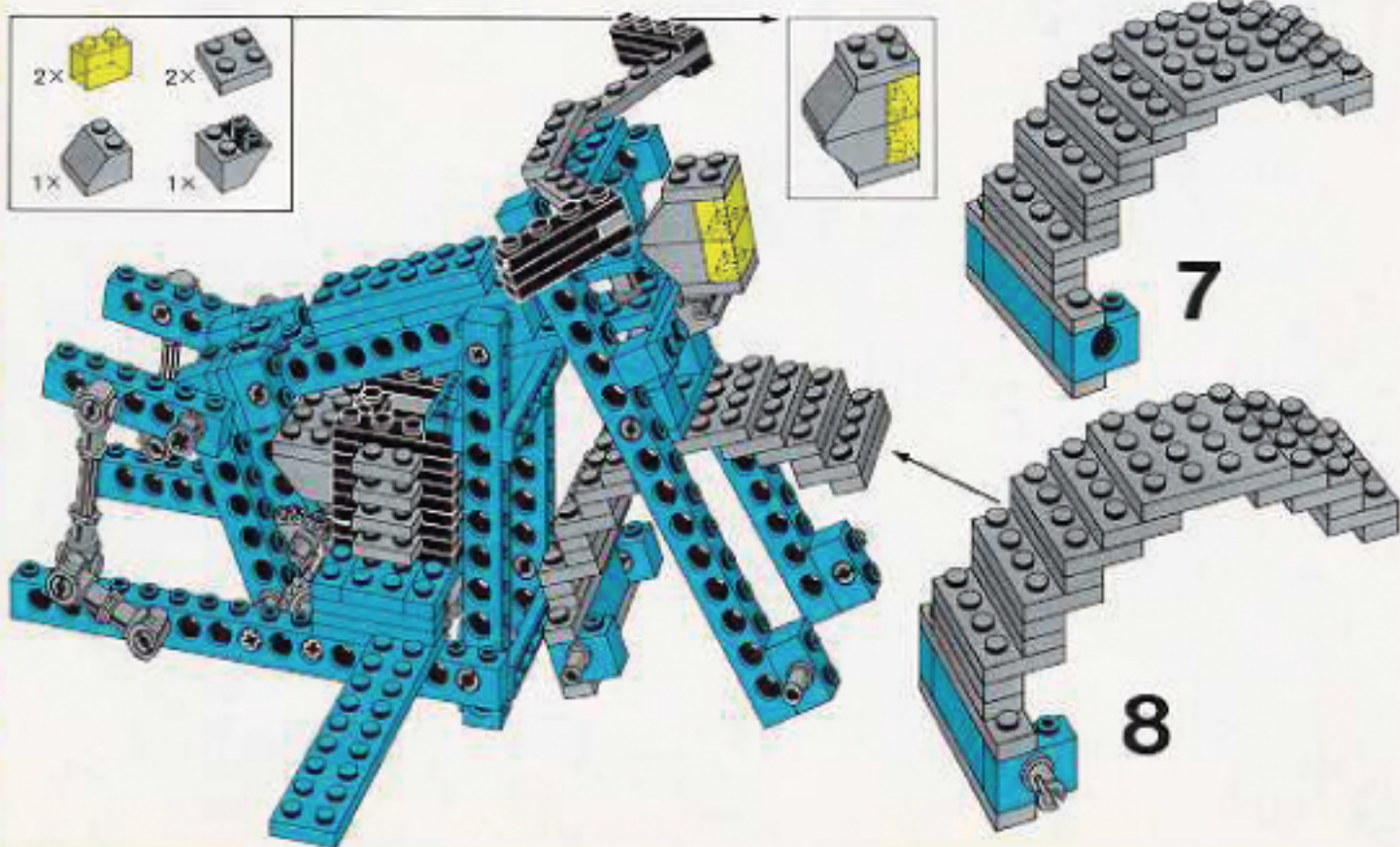
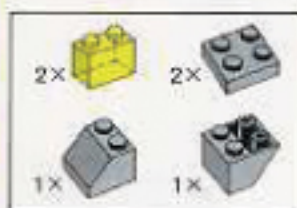
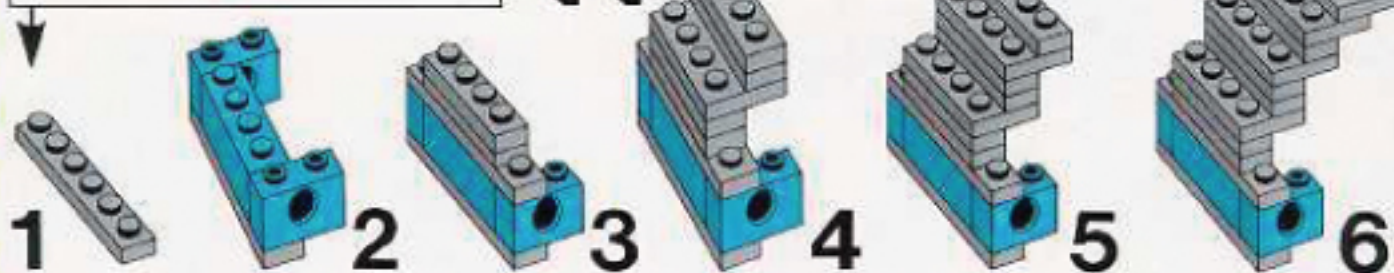

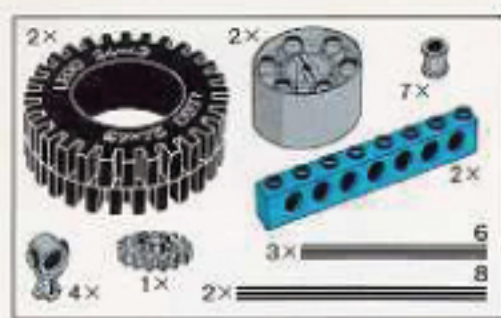

15

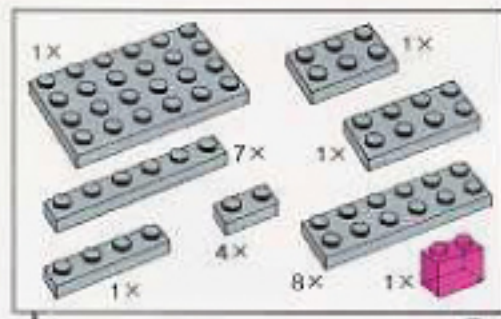
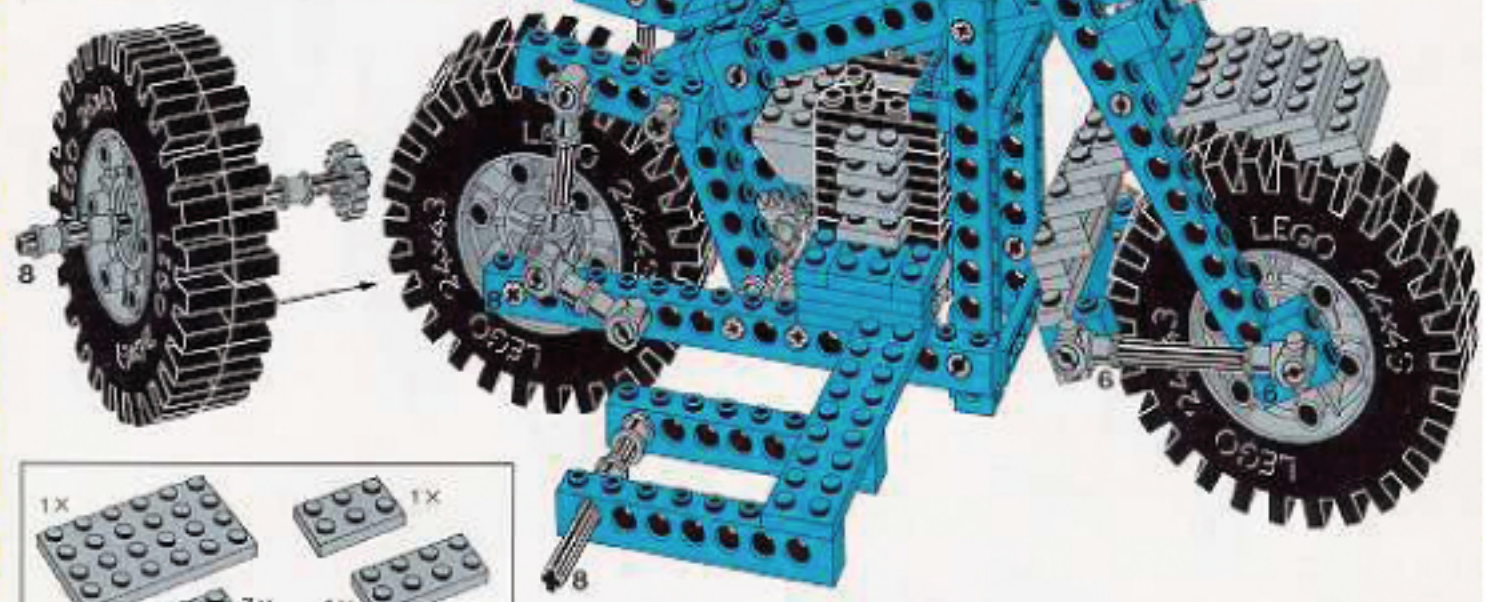

16

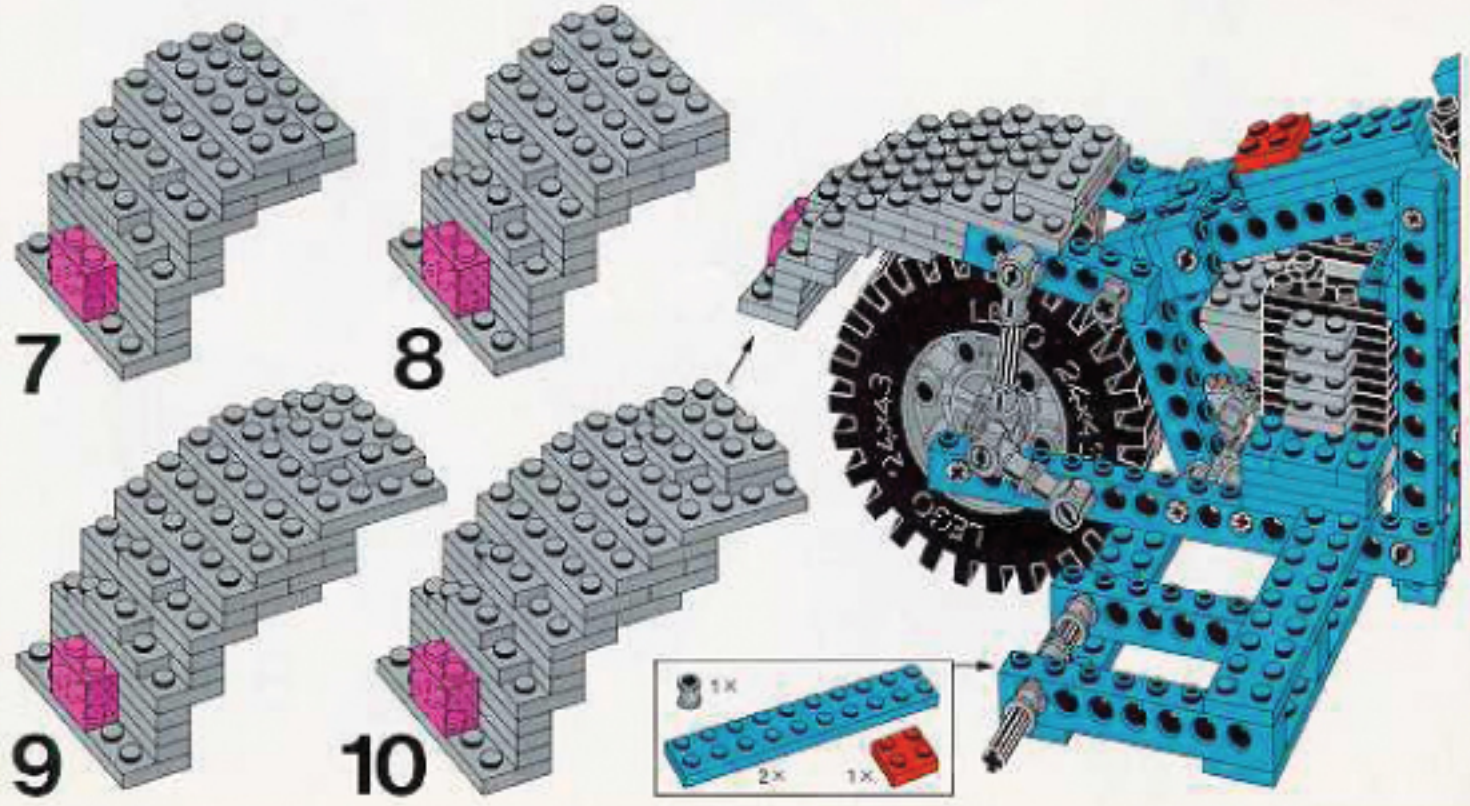
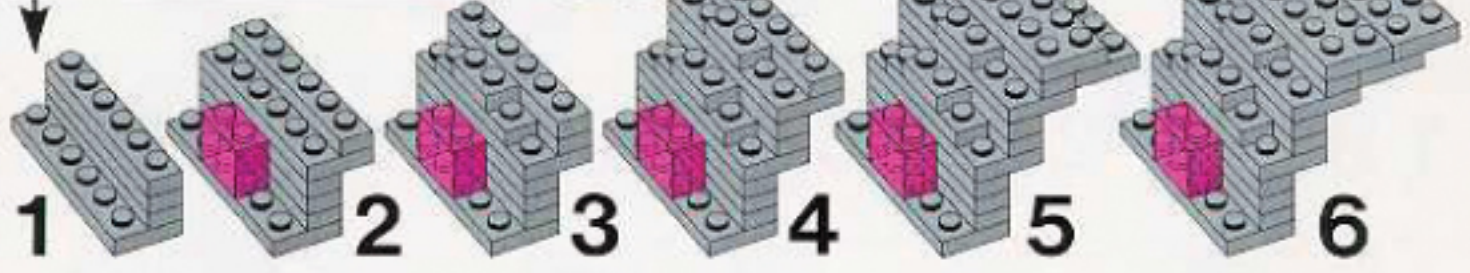

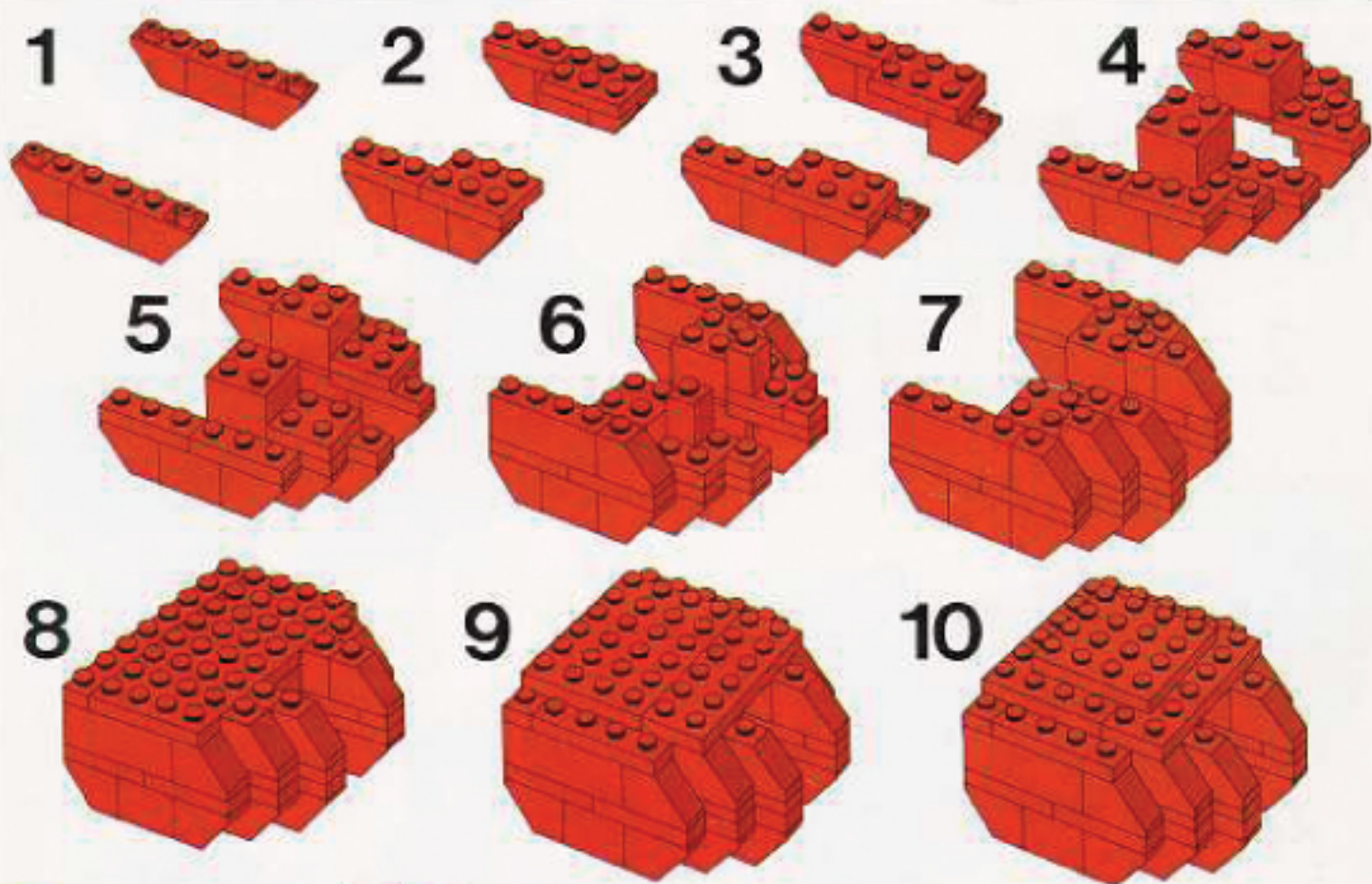
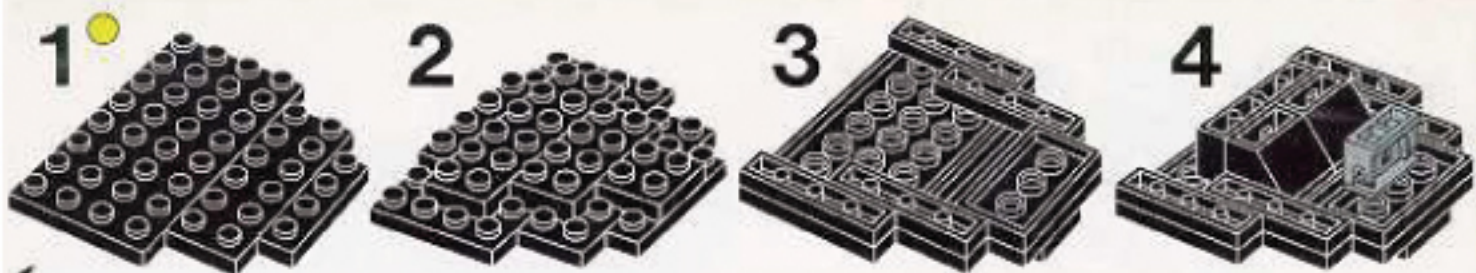

17

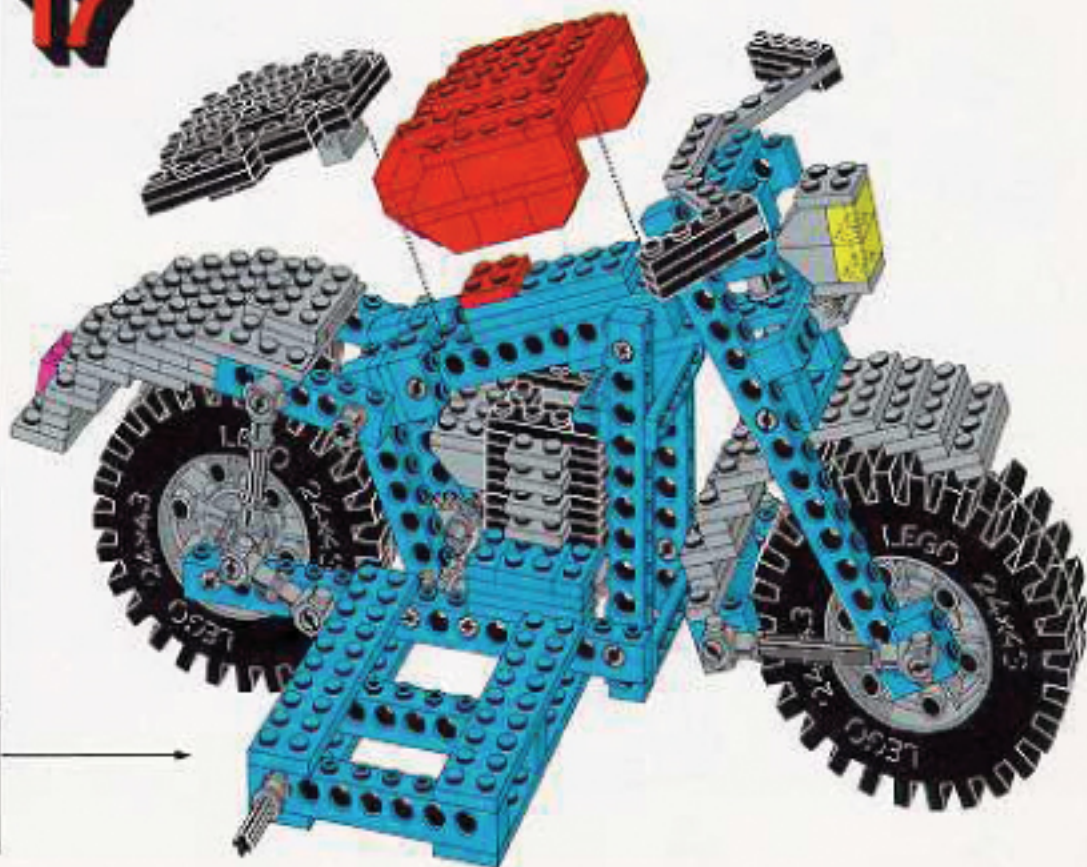
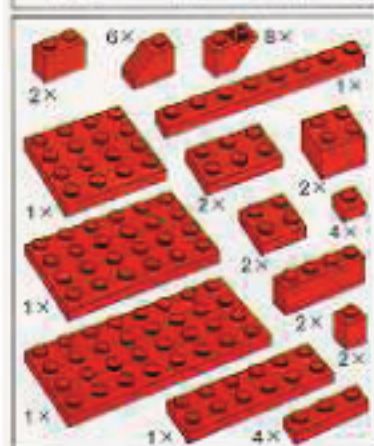

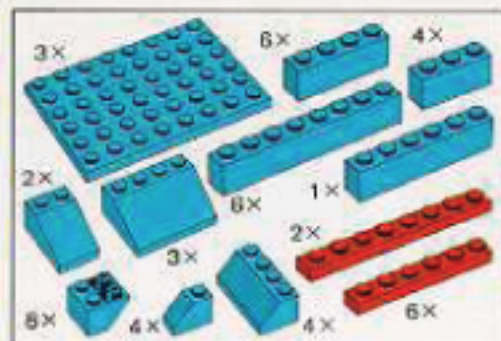

18

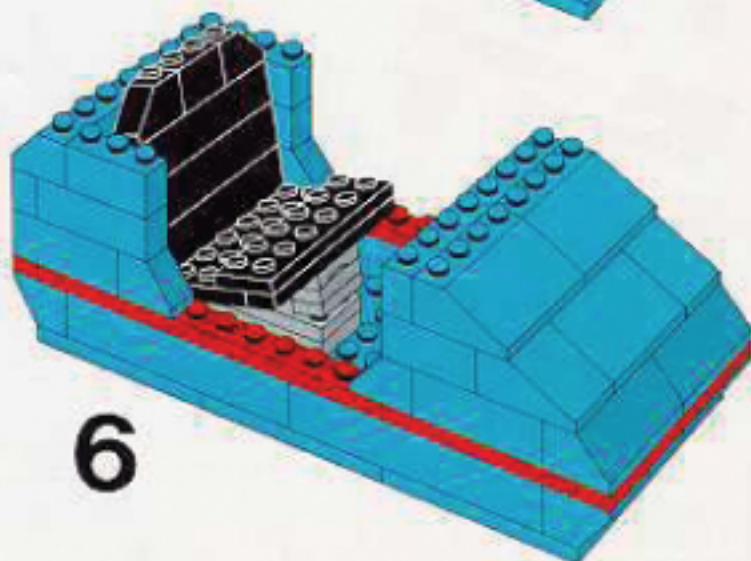
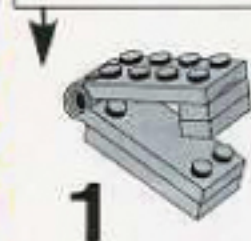
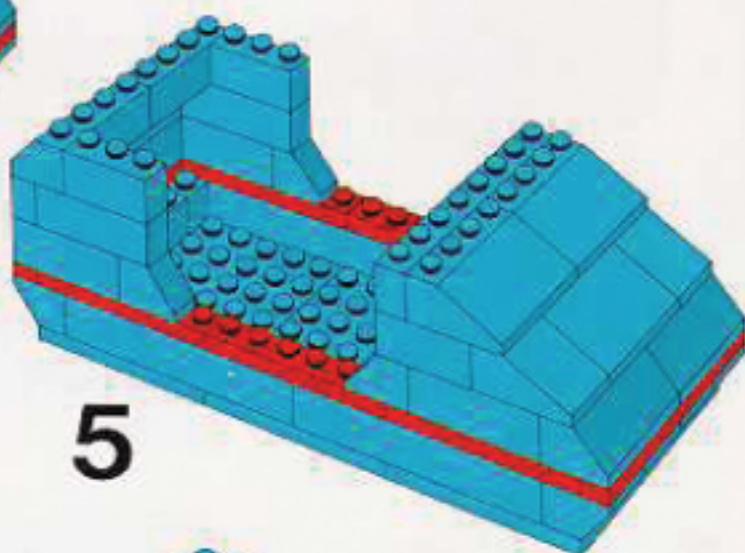
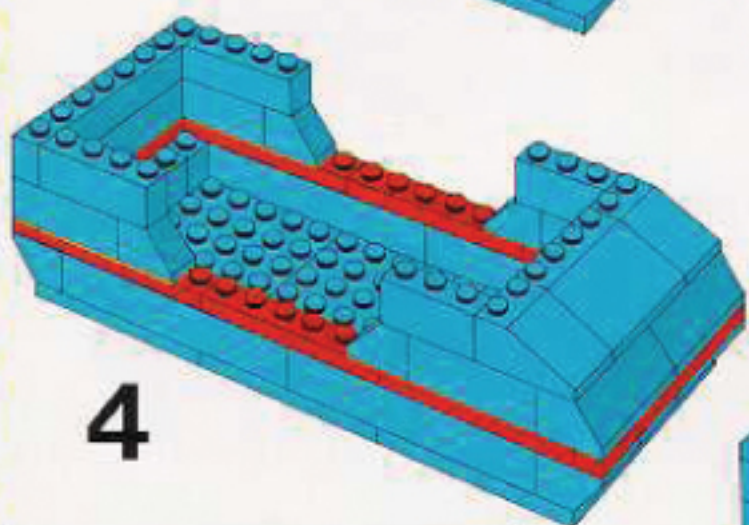
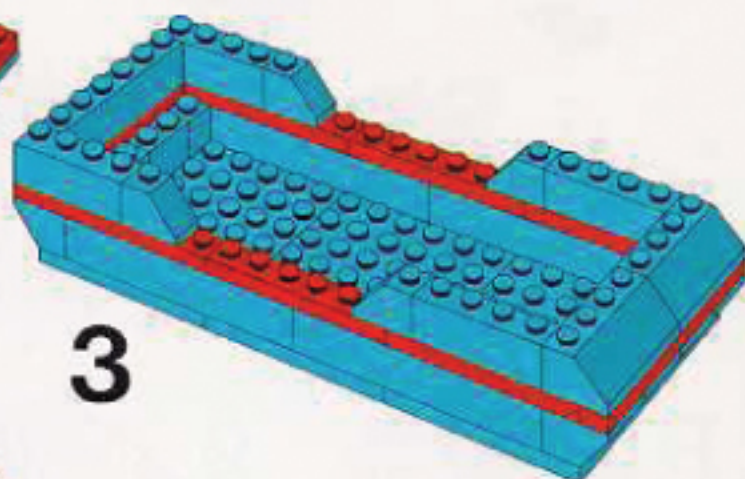
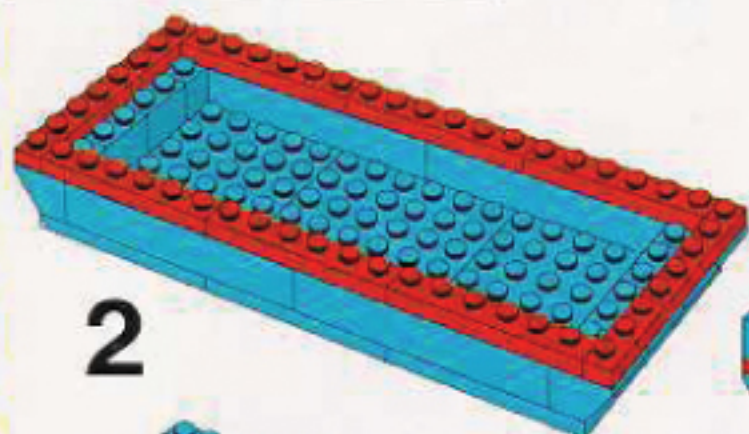
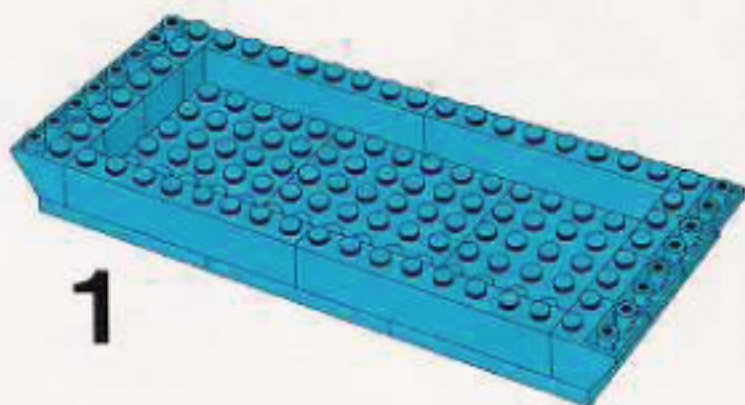

19

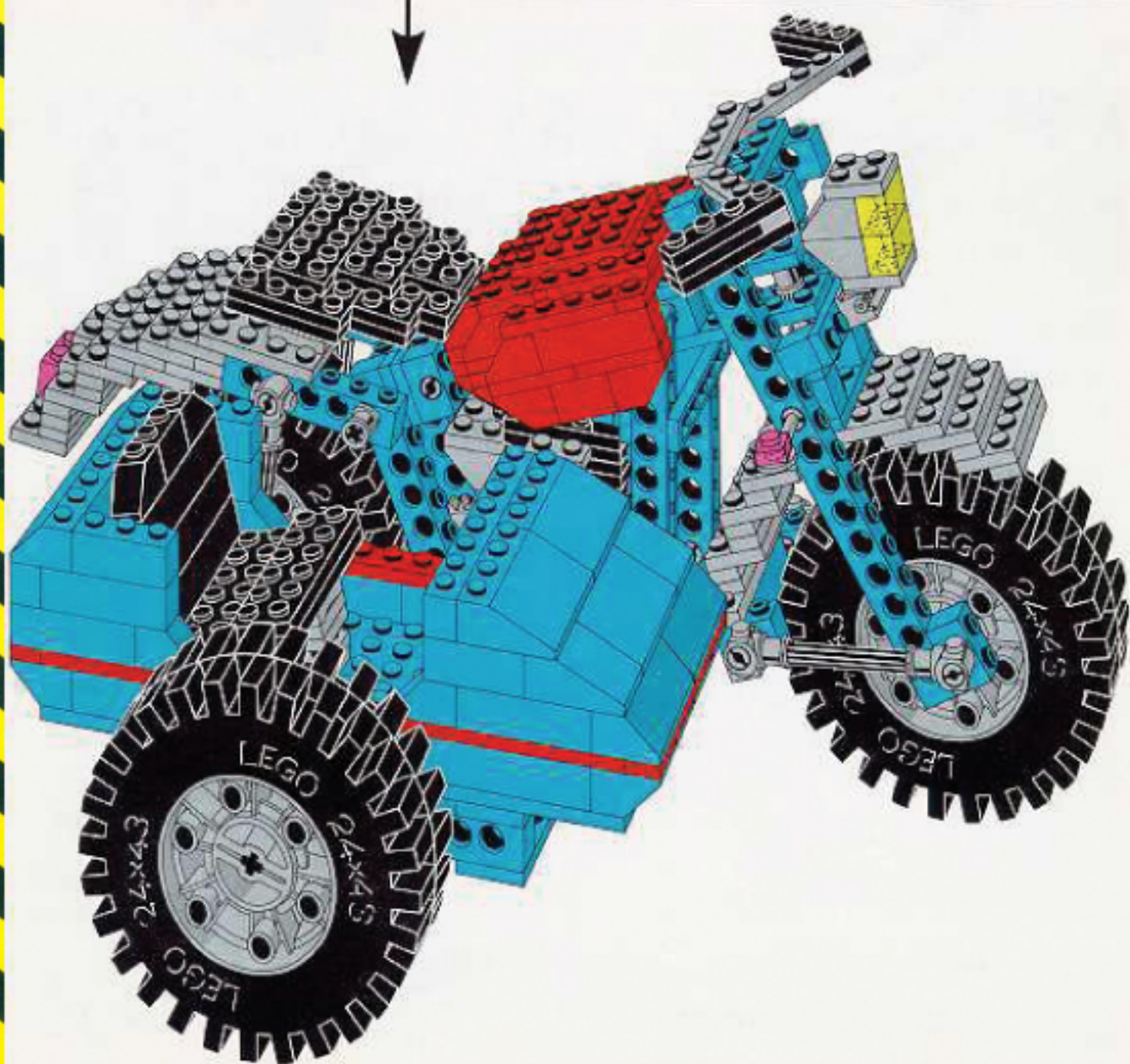
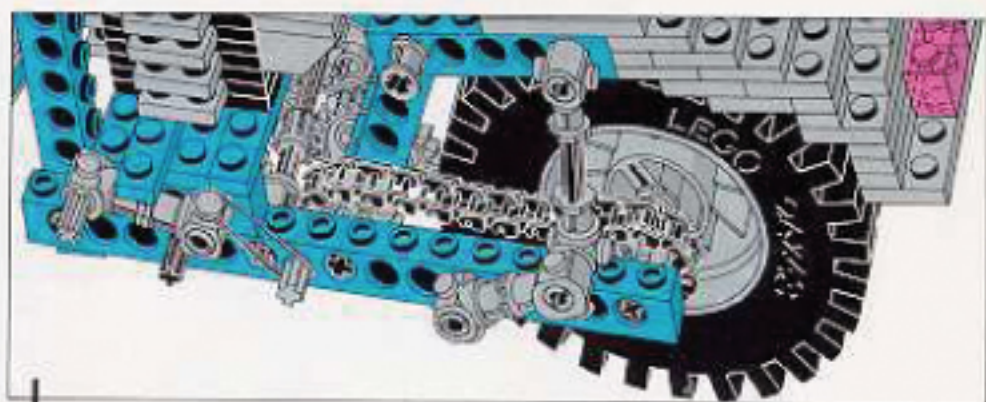



1

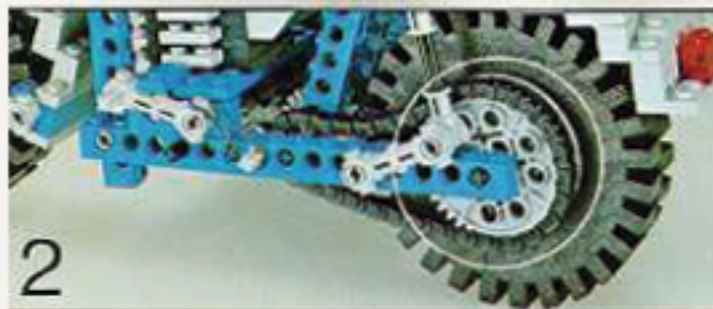

2



2



3



3



Art. No. 870

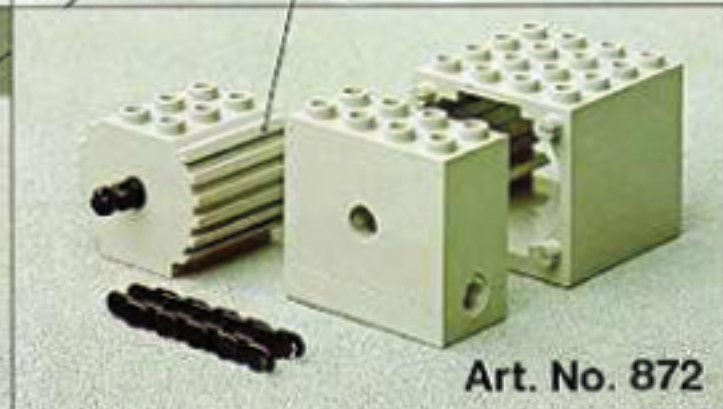

Art. No. 872

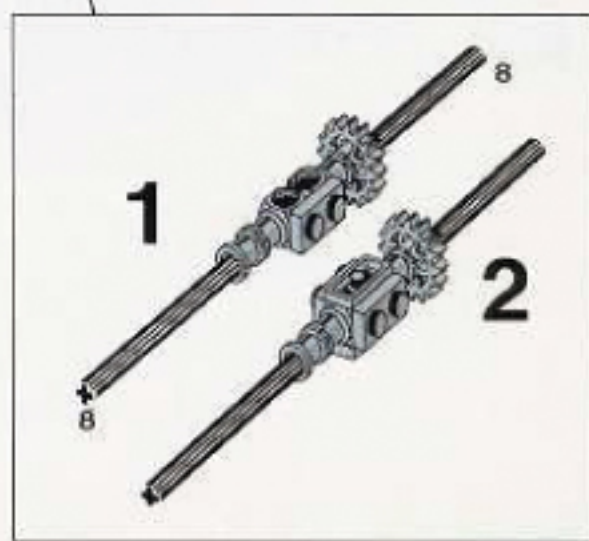
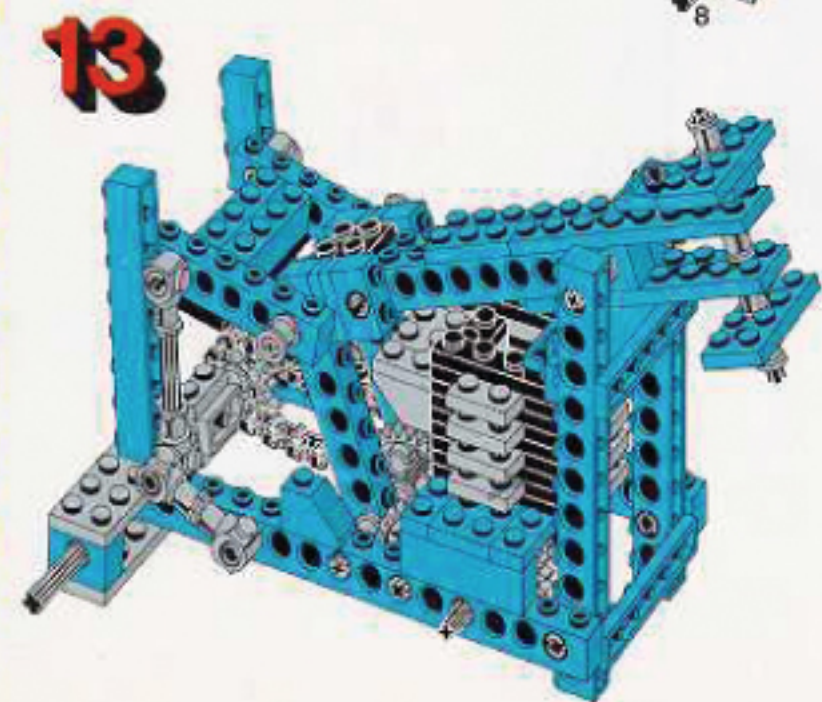
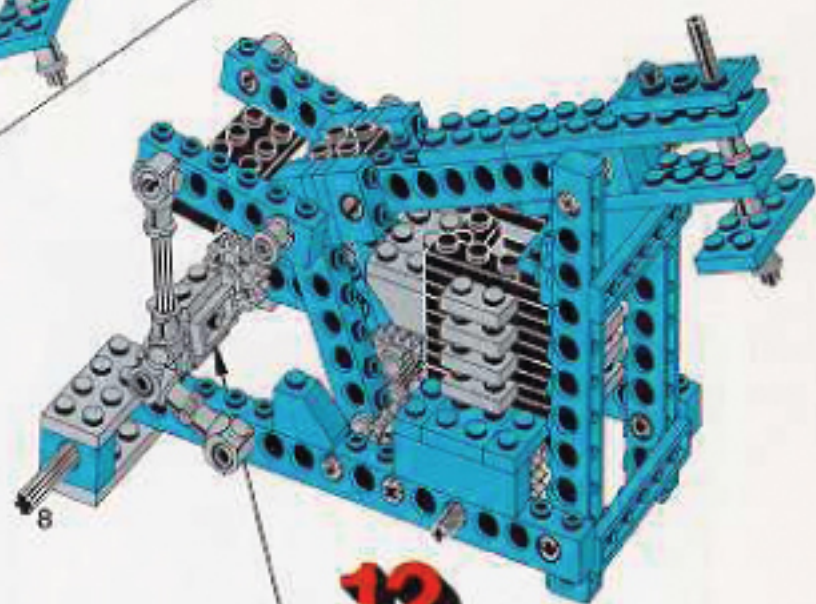
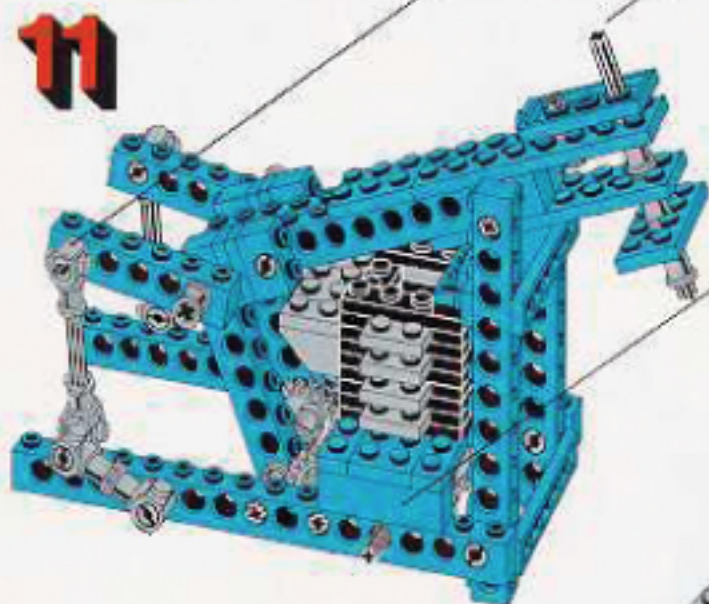
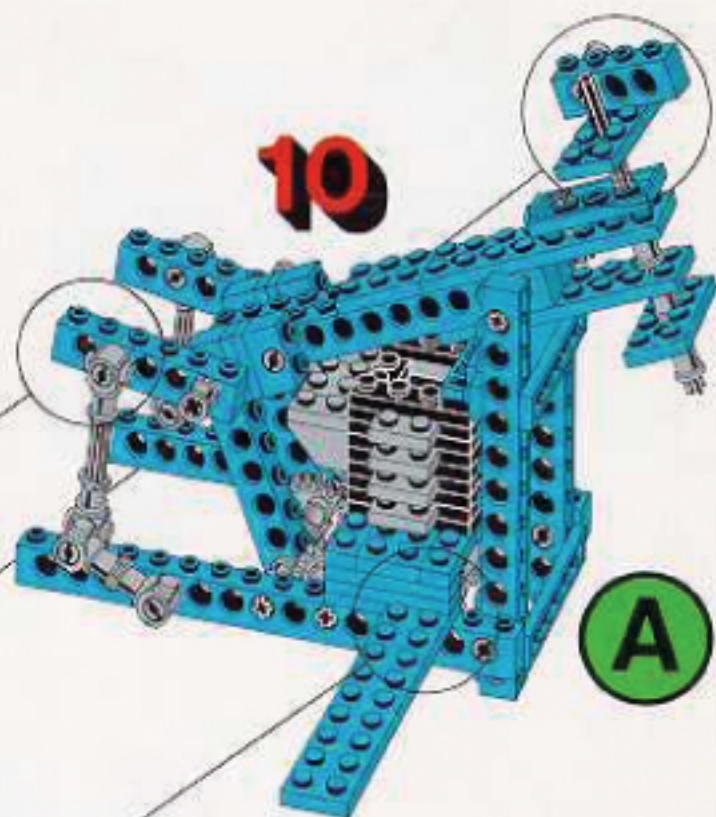

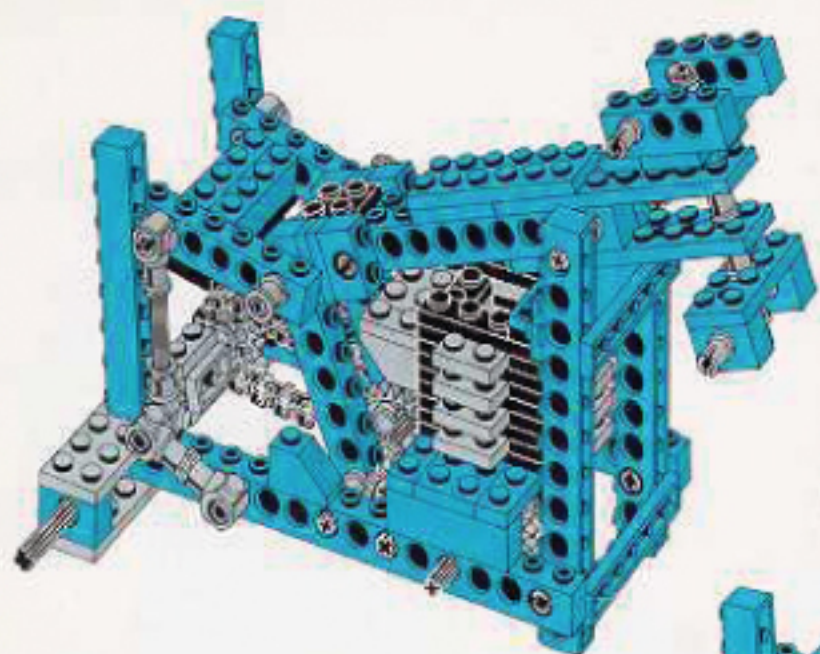

14

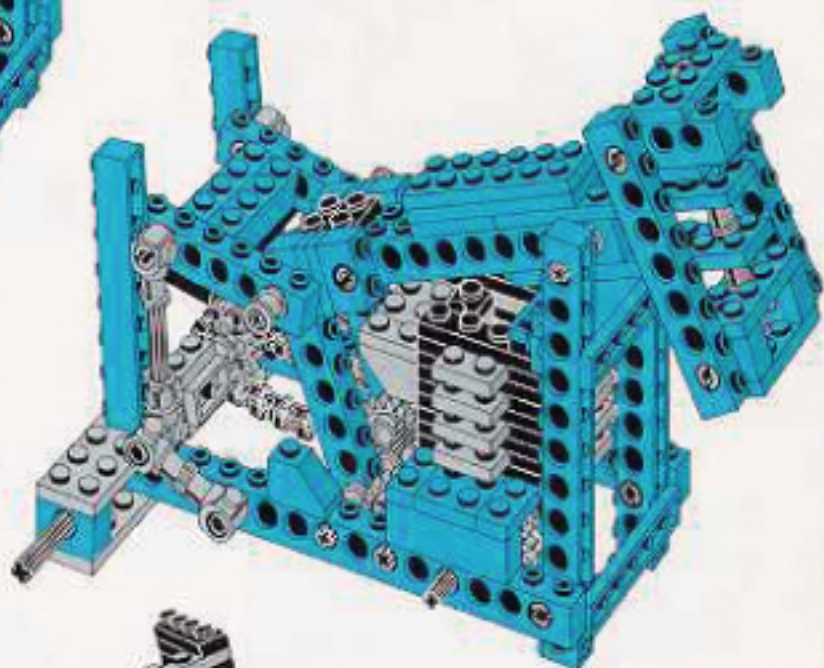

15

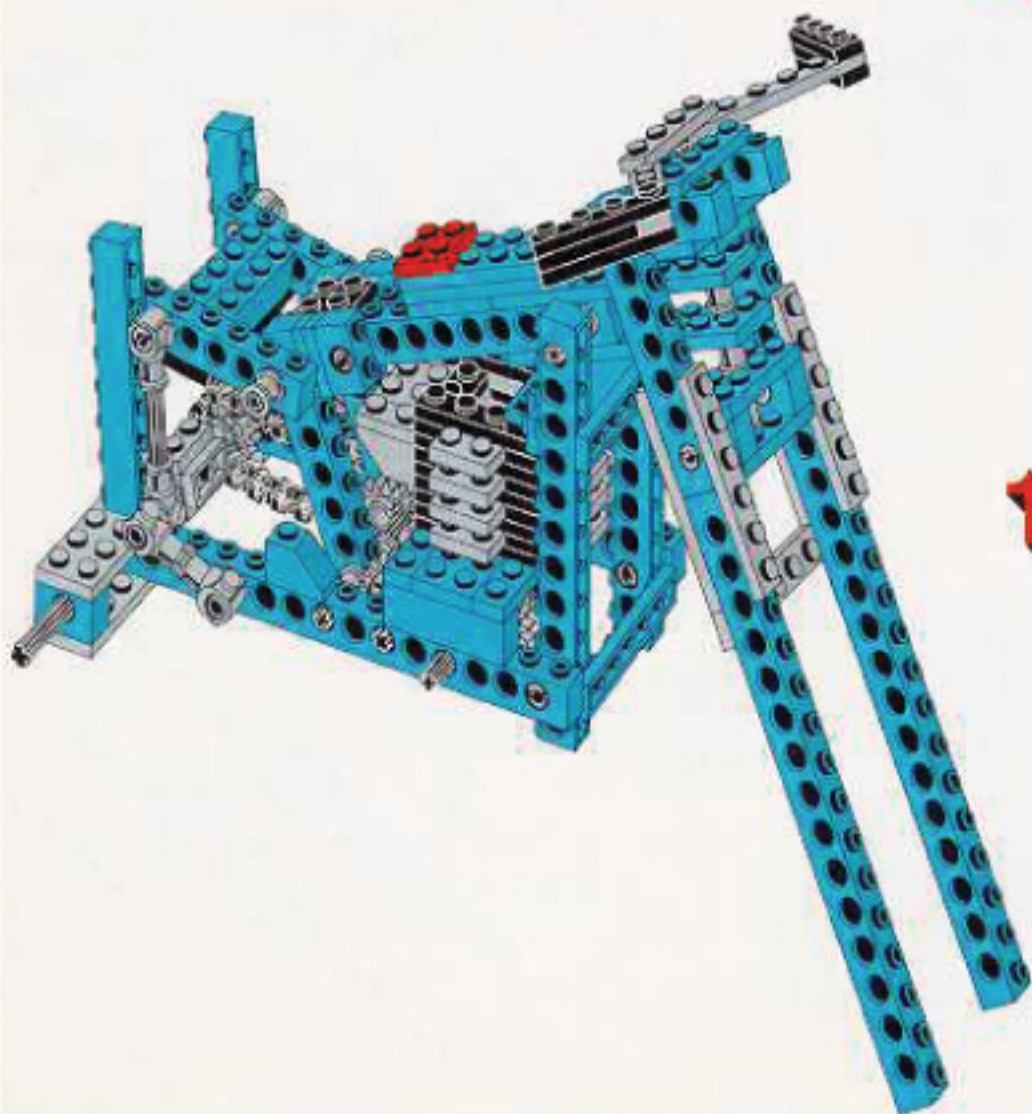

16

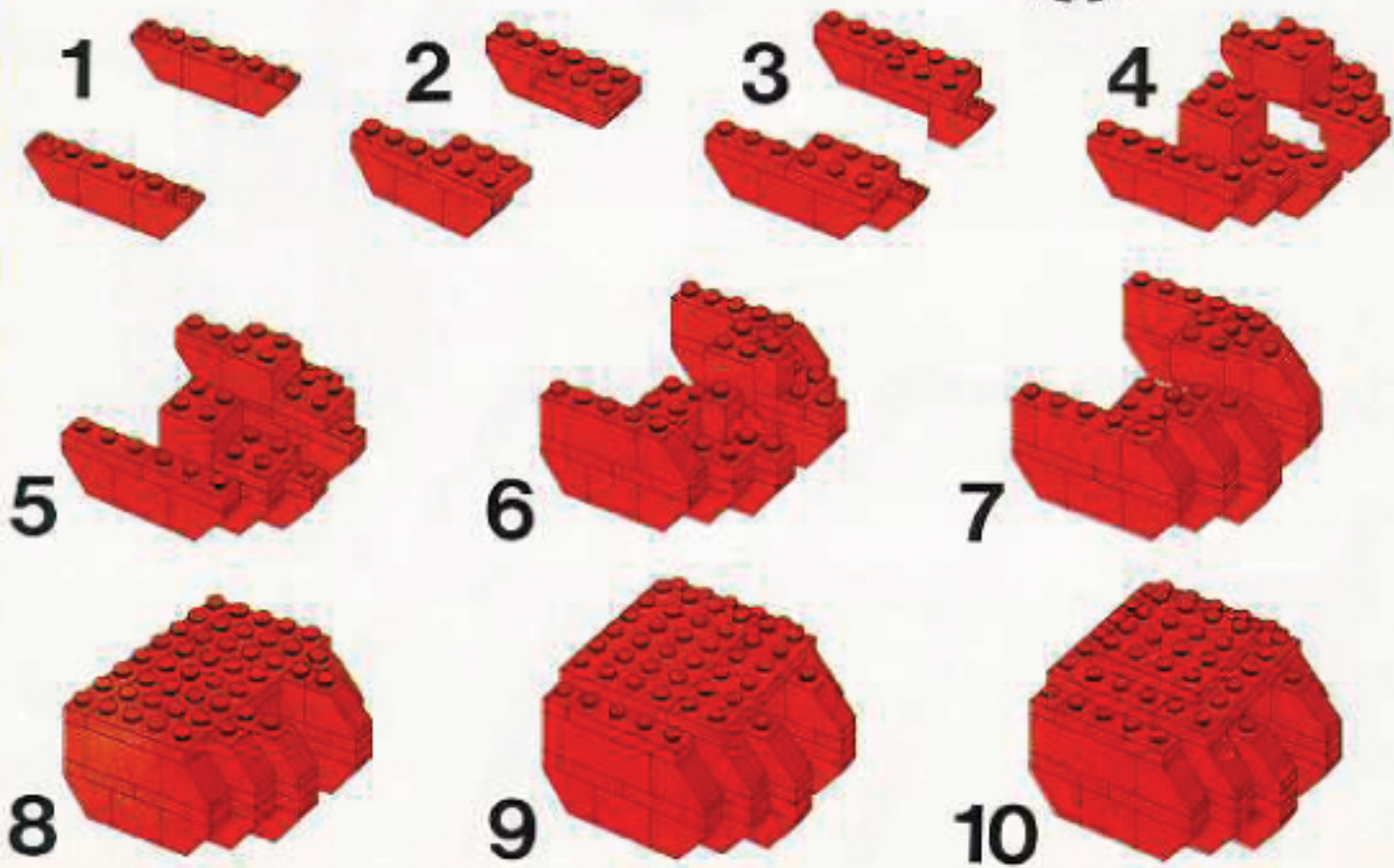
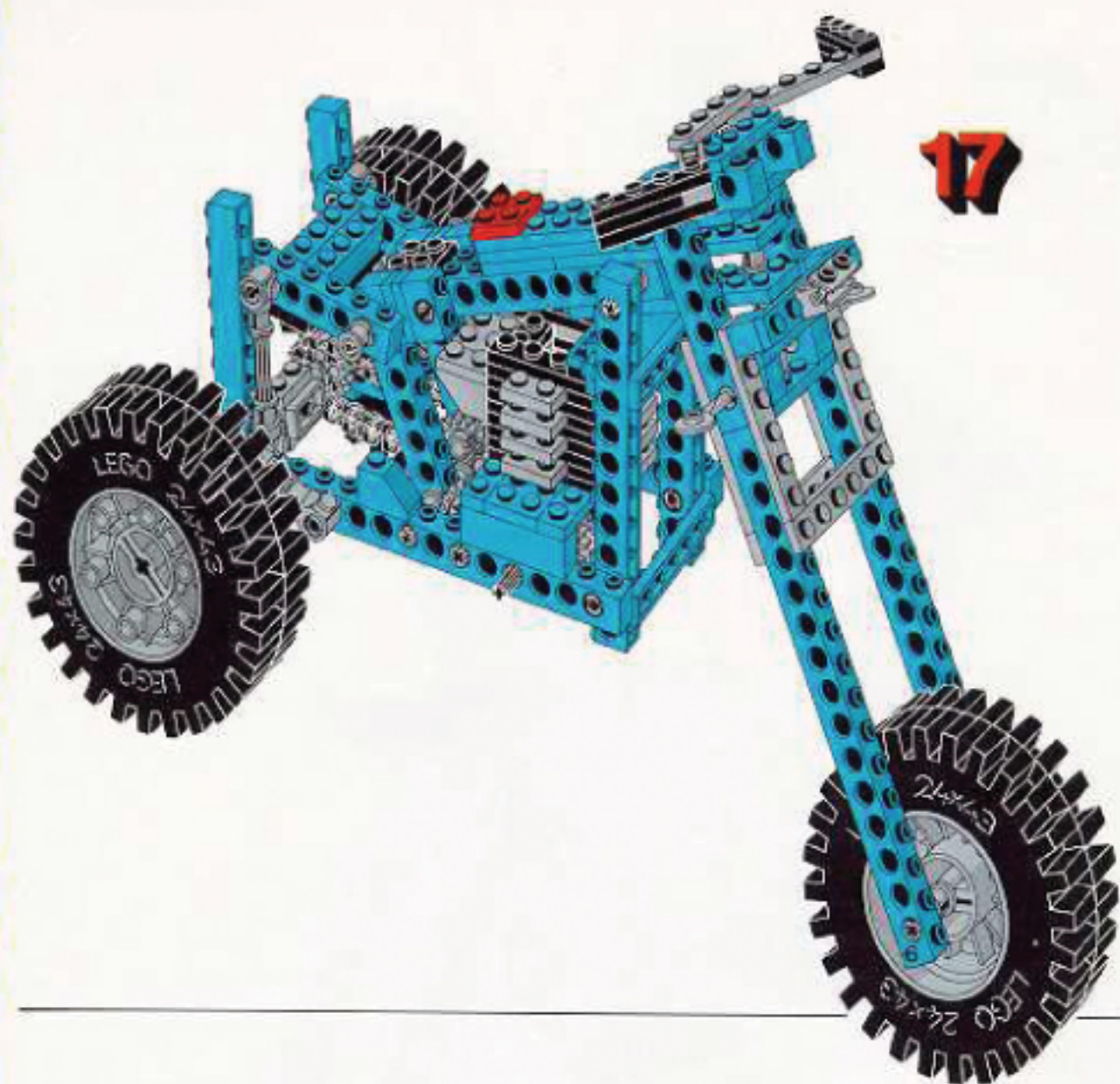

1



2



3

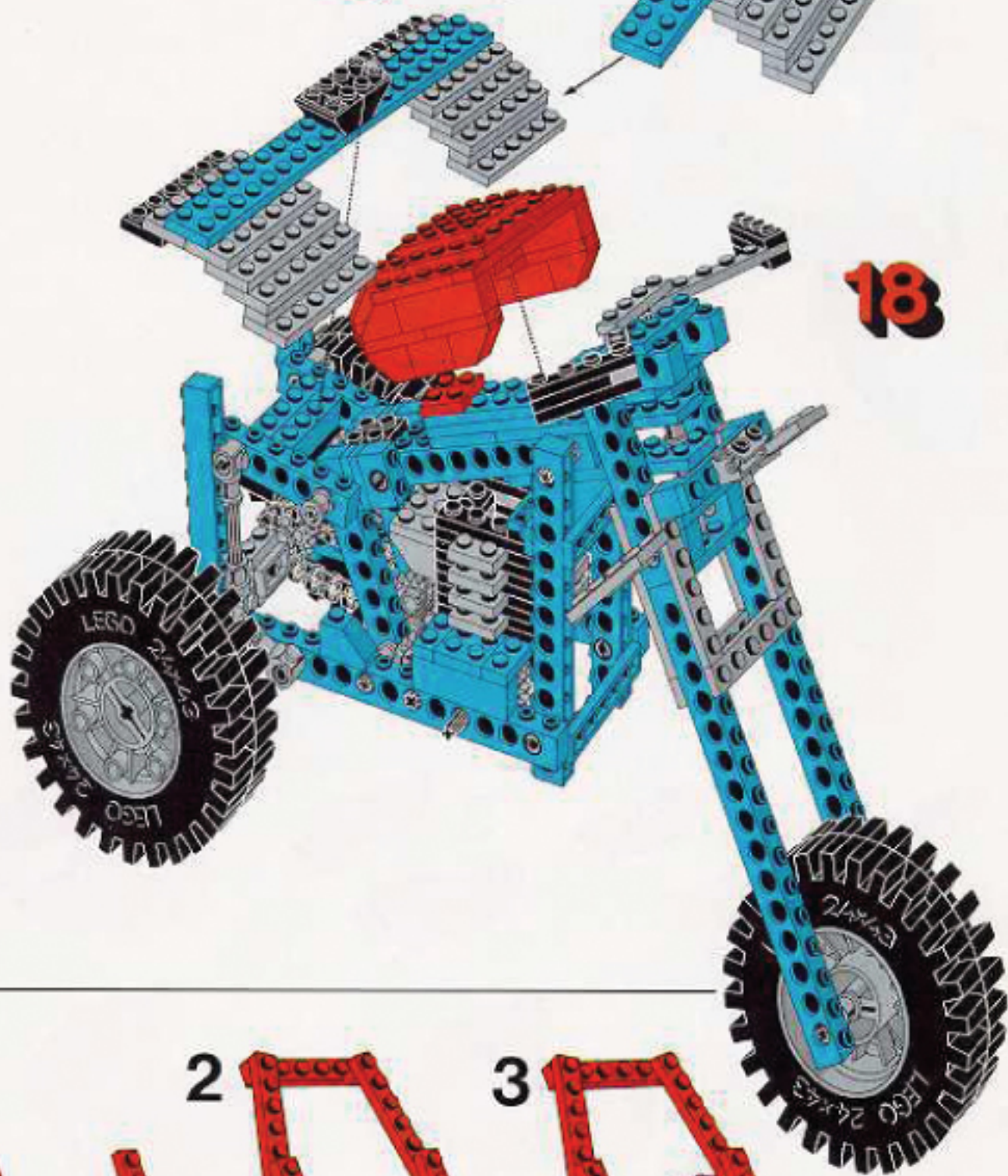

18

1



2



3



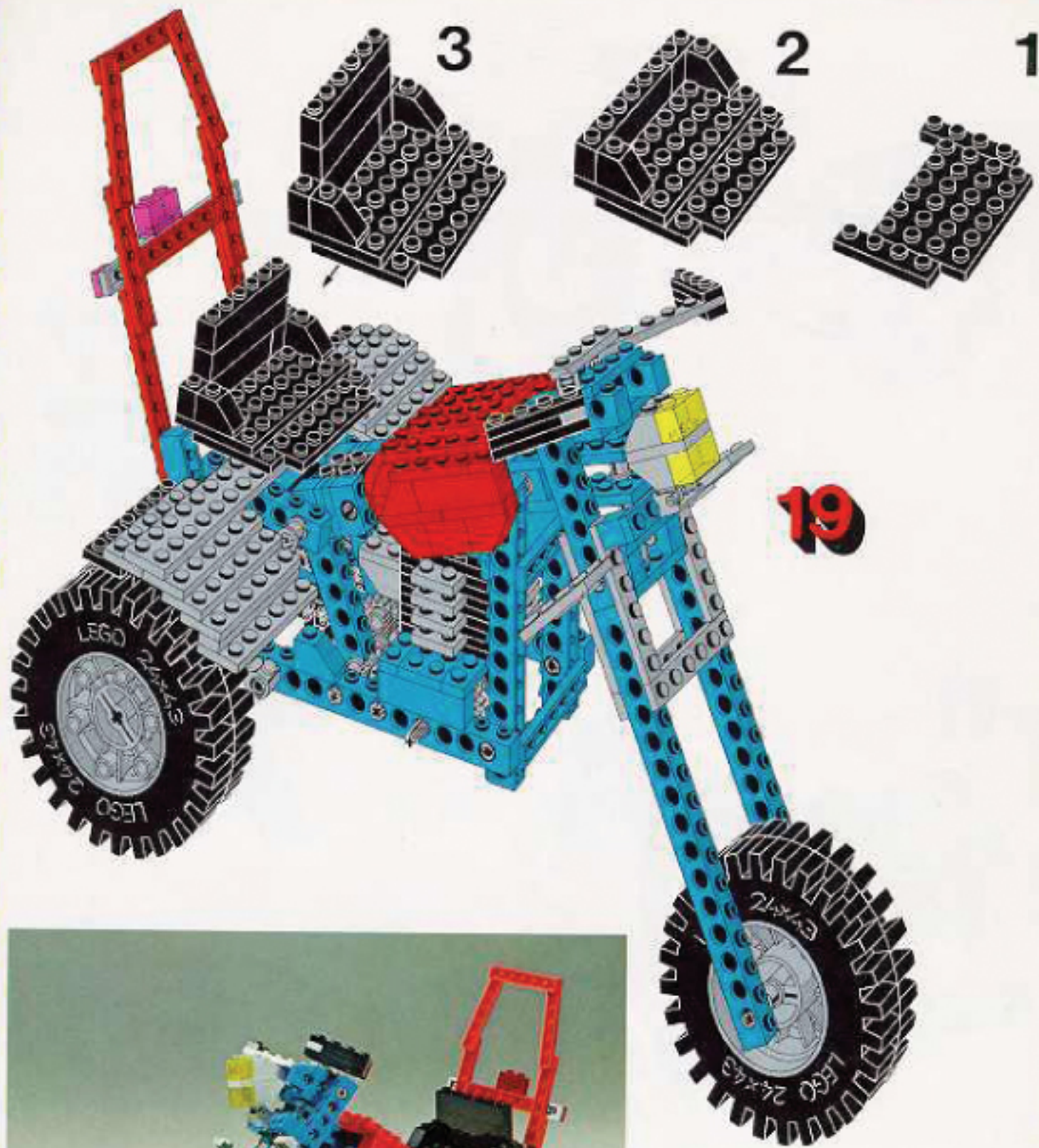

Art. No. 870



10

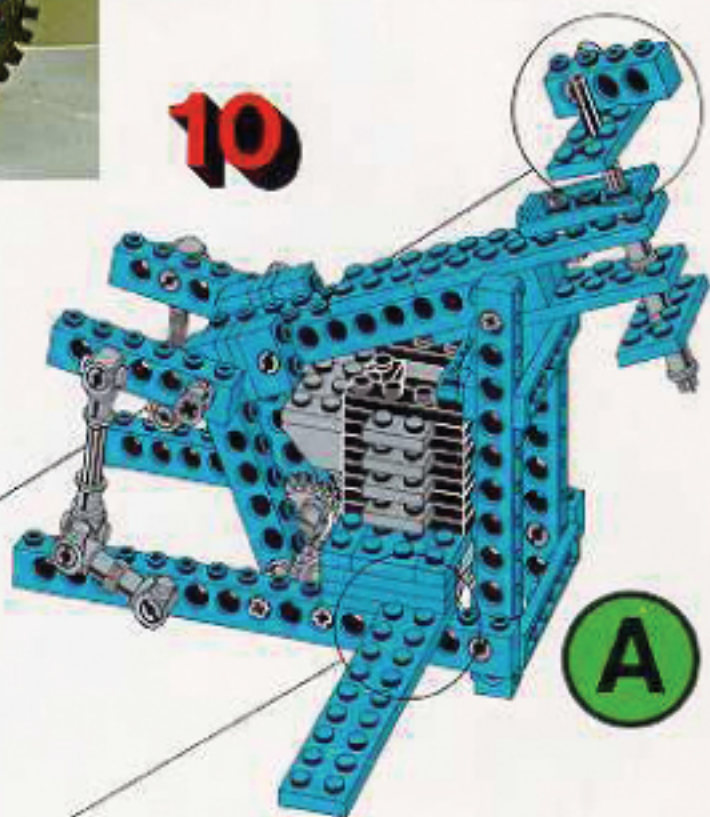

11

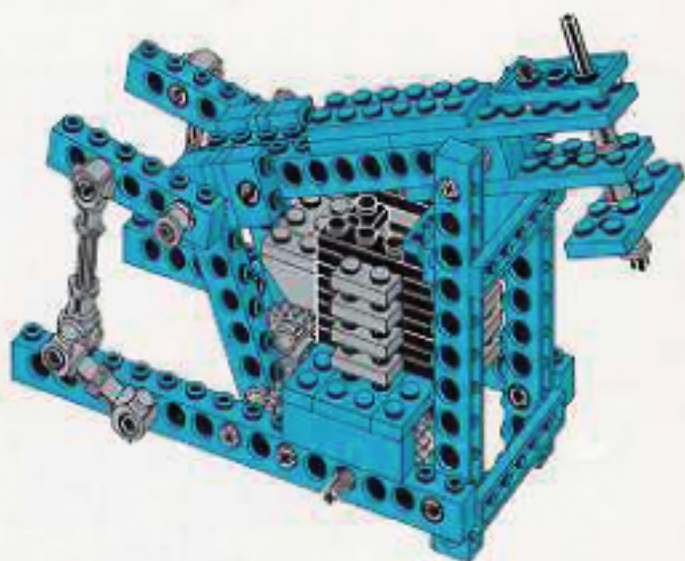
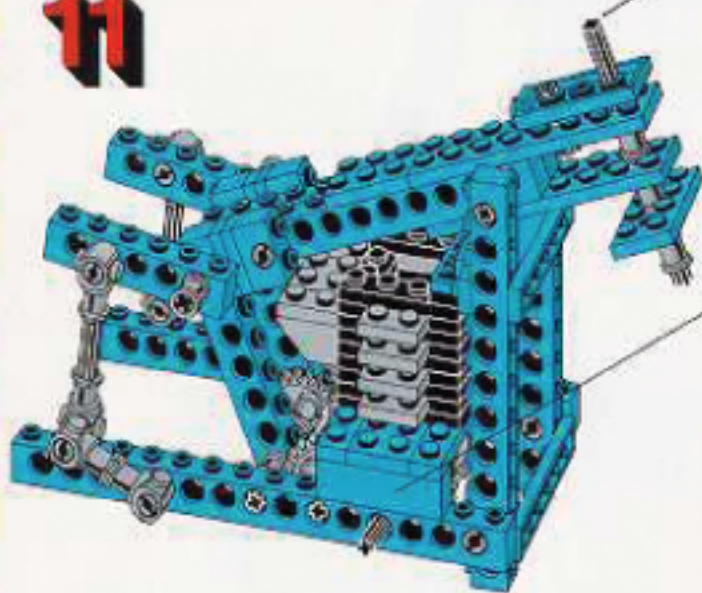

12

13

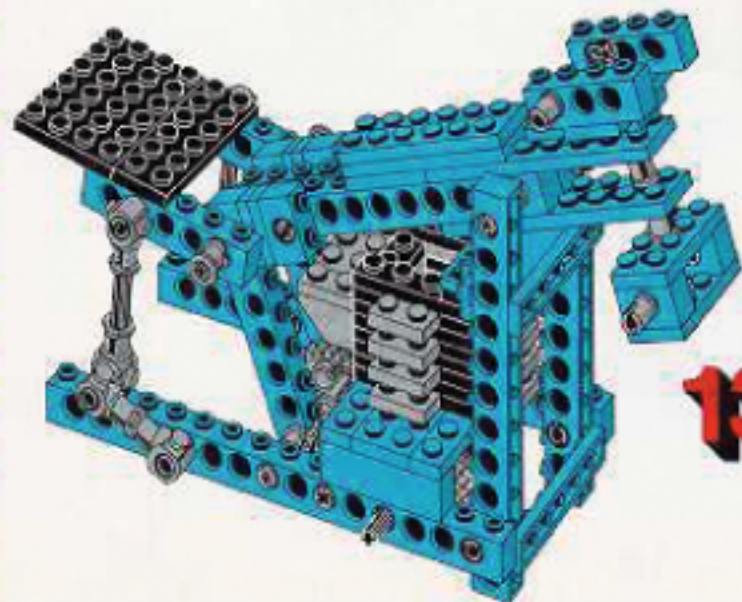

14

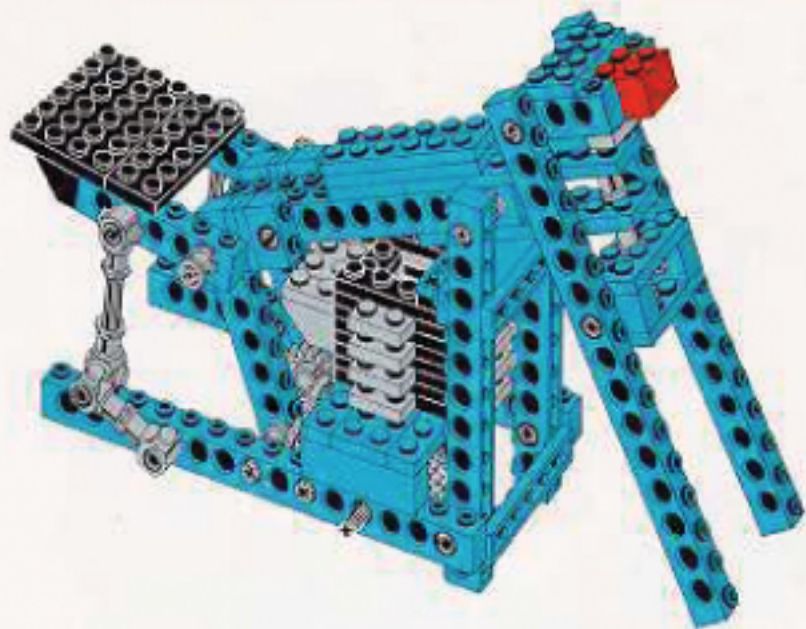

15

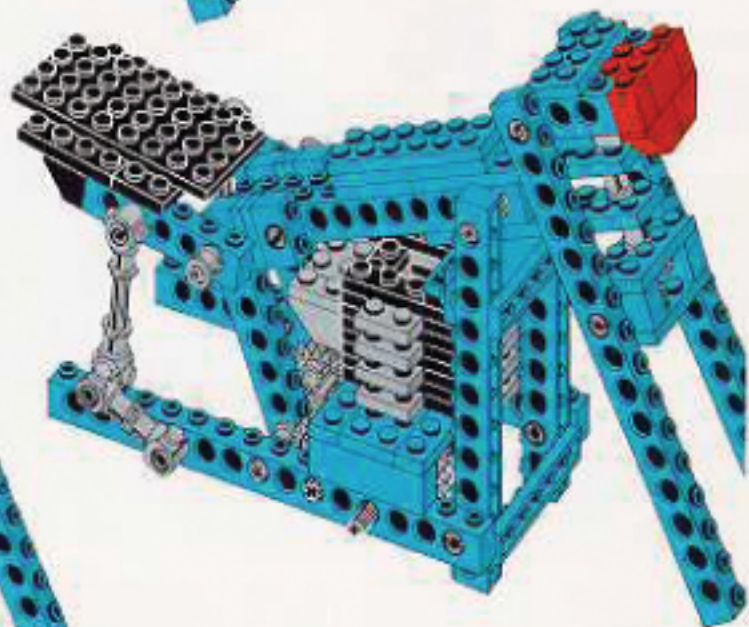

16

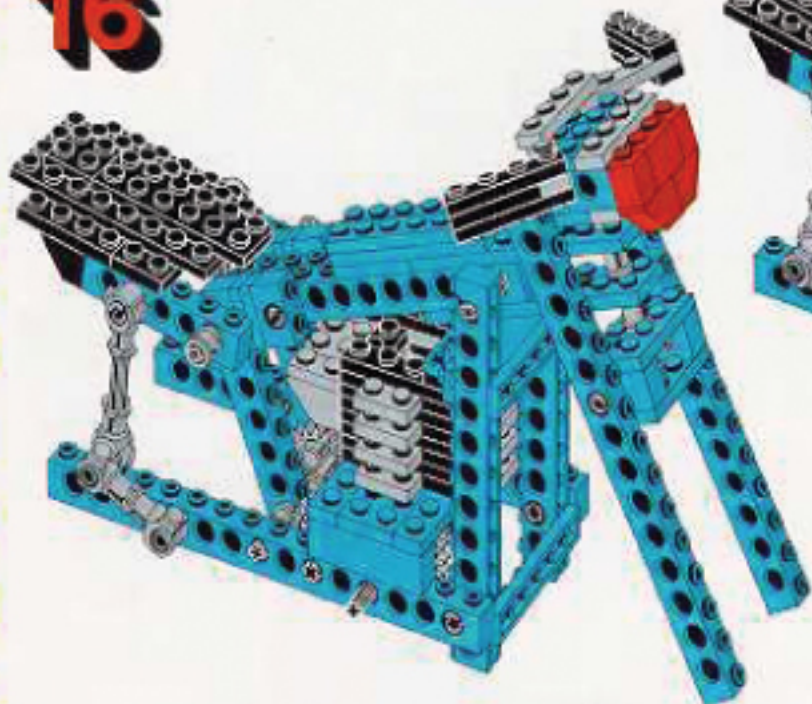

17

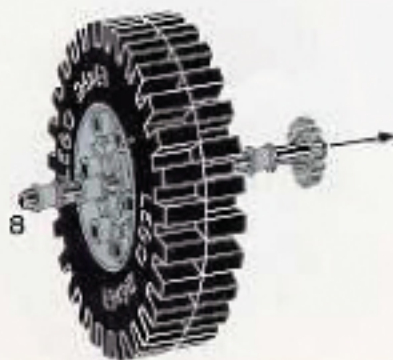
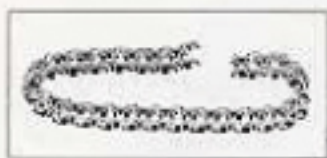
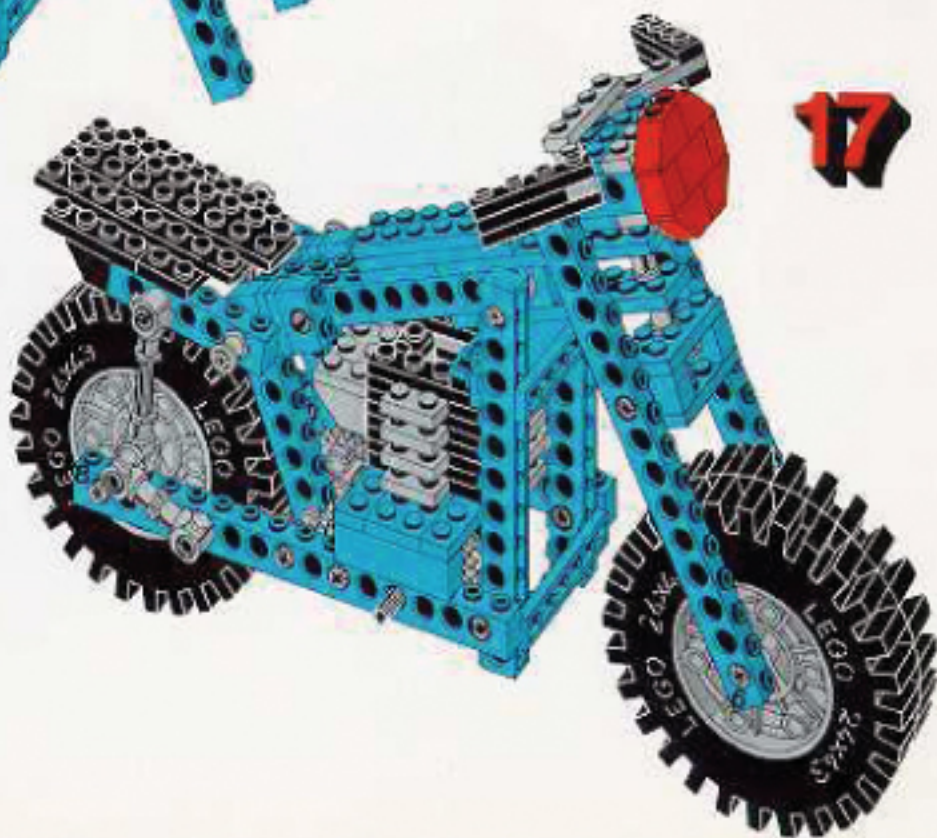



18

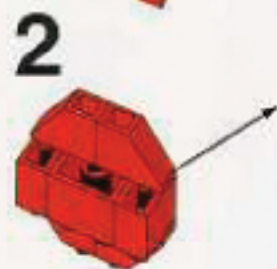
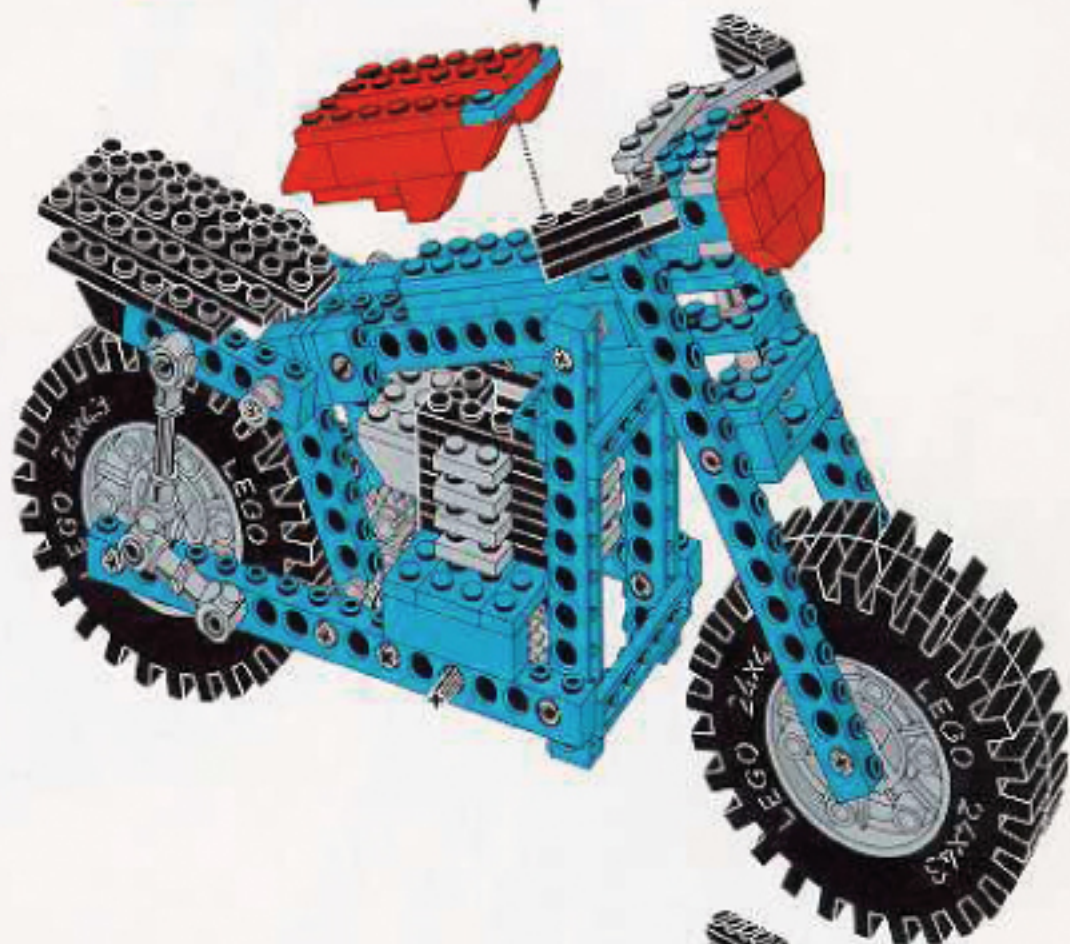

19

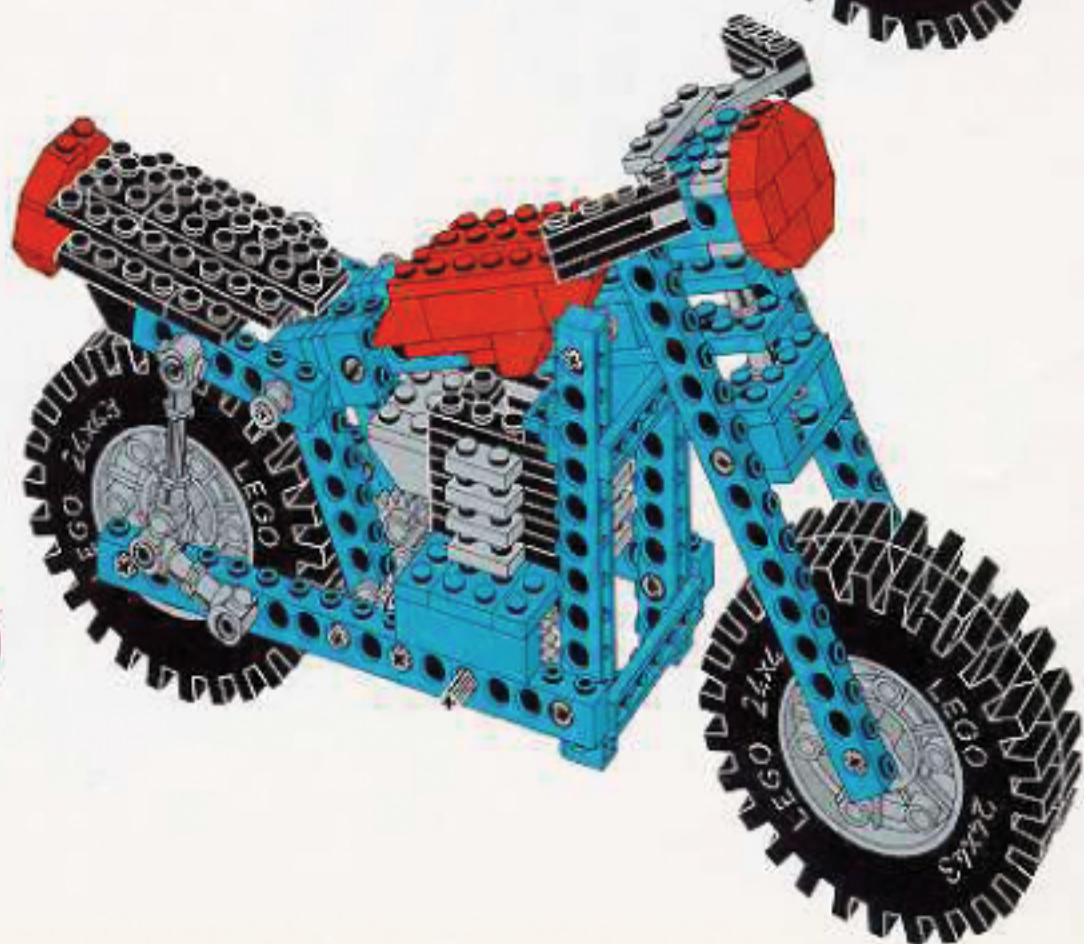

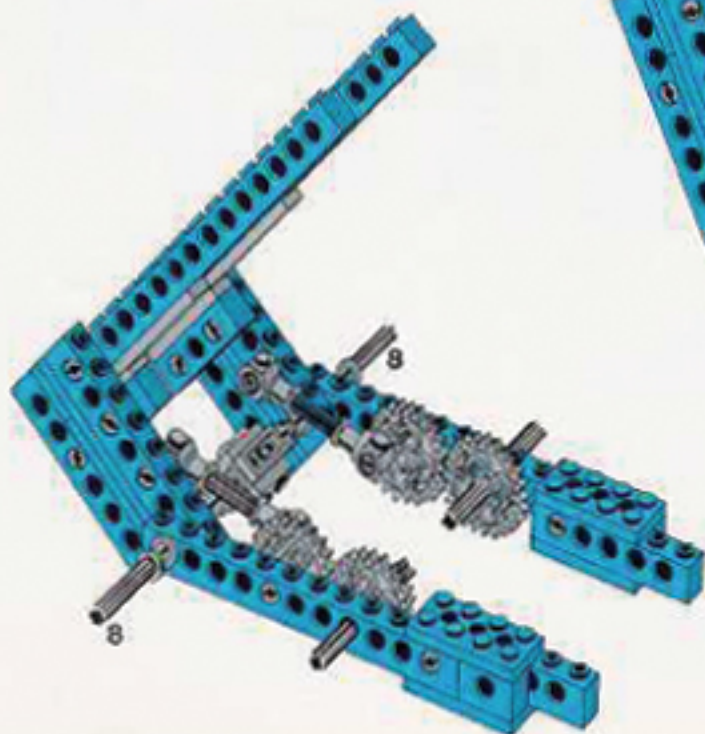
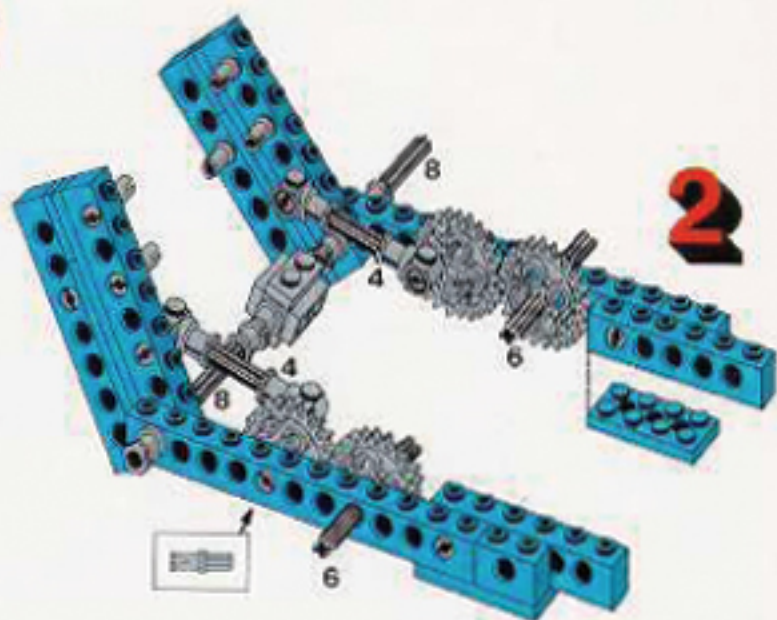
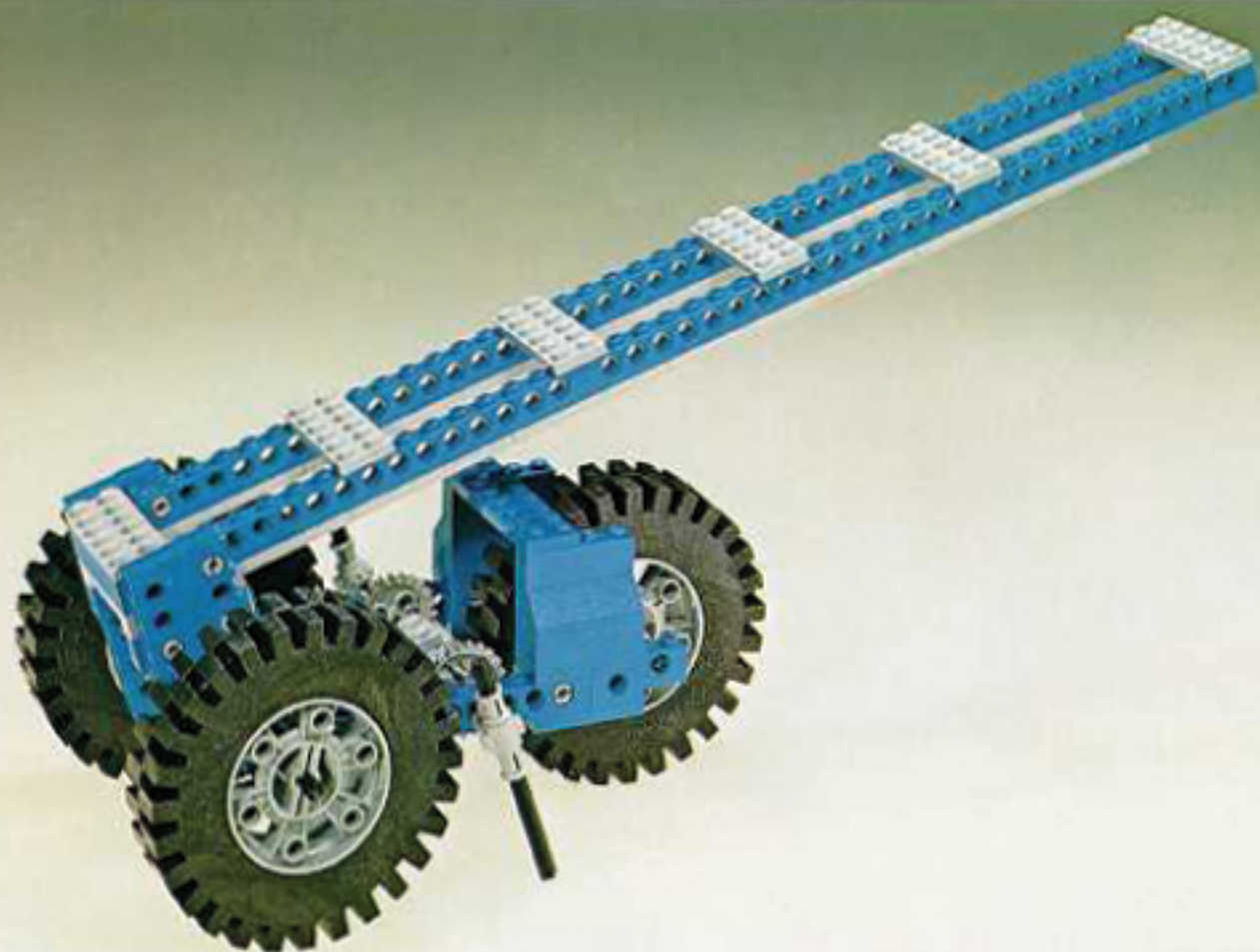

3

4

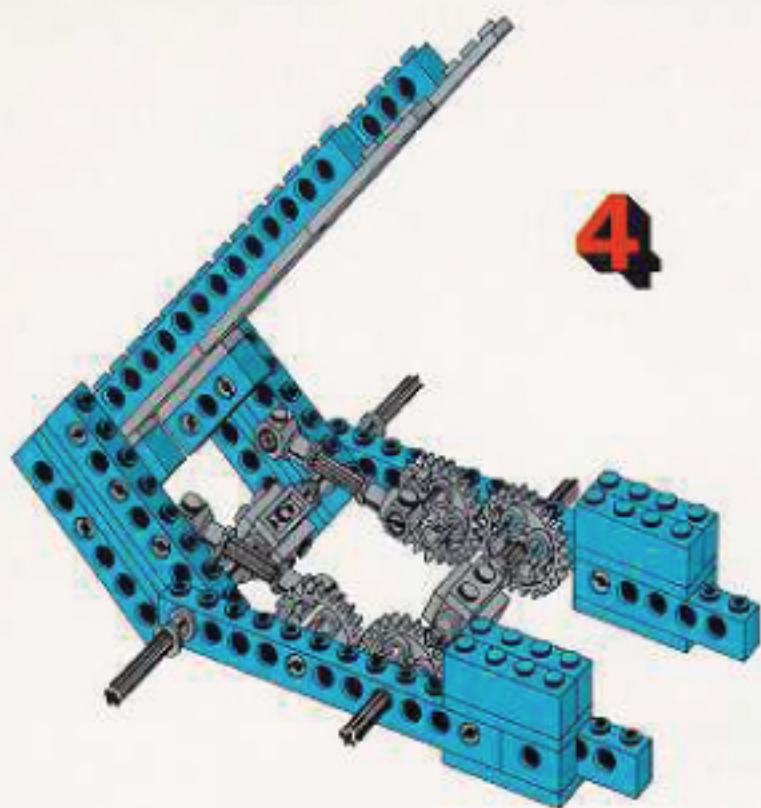

5

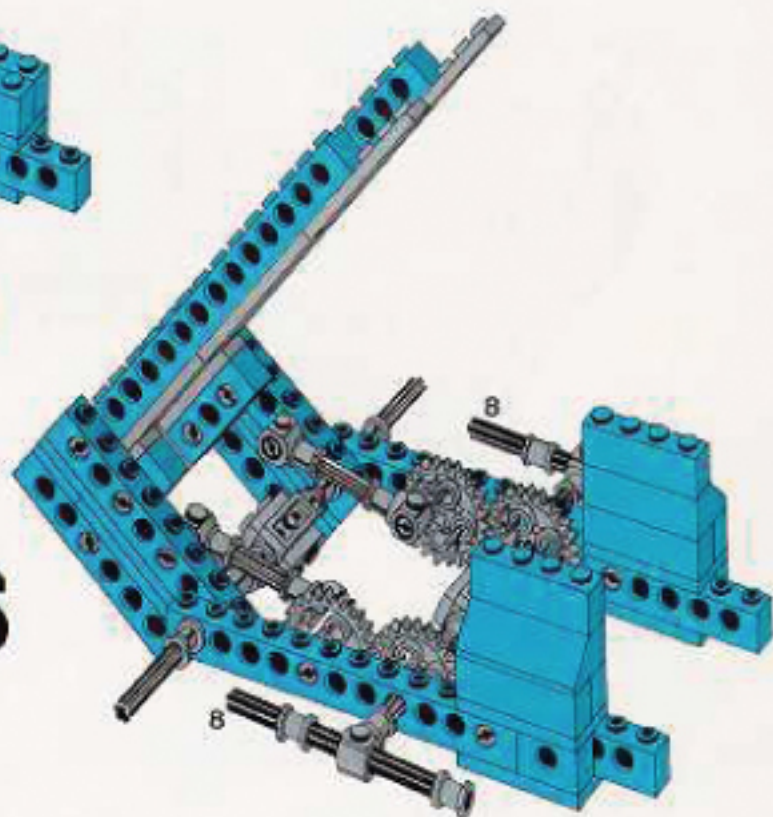

6

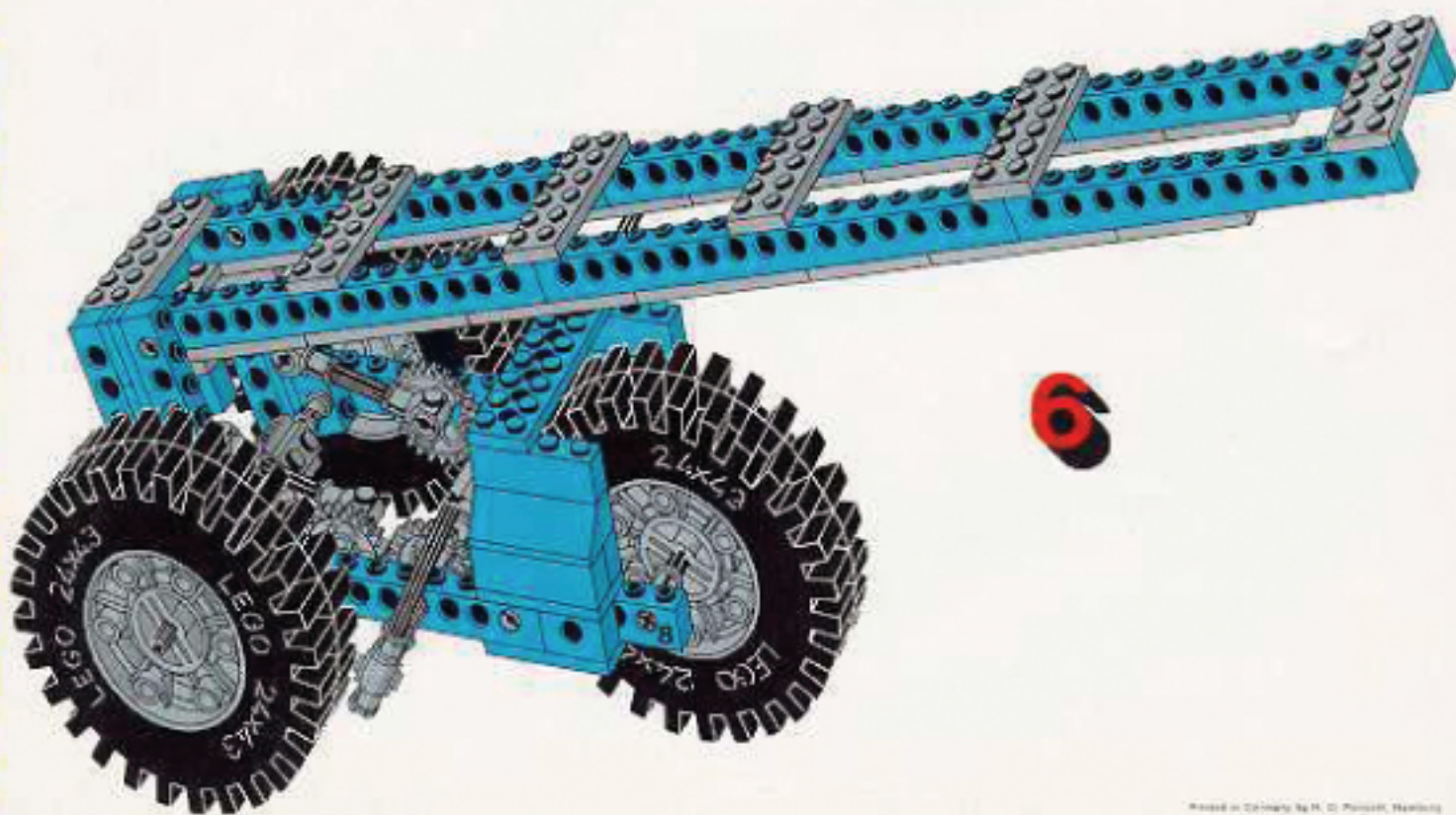



Image	Qty	Item No	Description	MID
-------	-----	---------	-------------	-----

Regular Items:

Parts:

	1	3004	Black Brick 1 x 2 Catalog: Parts: Brick	PG
---	---	----------------------	---	--------------------

	1	3010	Black Brick 1 x 4 Catalog: Parts: Brick	PG
---	---	----------------------	---	--------------------

	3	3009	Black Brick 1 x 6 Catalog: Parts: Brick	PG
---	---	----------------------	---	--------------------

	3	3023	Black Plate 1 x 2 Catalog: Parts: Plate	PG
---	---	----------------------	---	--------------------

	2	3623	Black Plate 1 x 3 Catalog: Parts: Plate	PG
--	---	----------------------	---	--------------------

	29	3710	Black Plate 1 x 4 Catalog: Parts: Plate	PG
---	----	----------------------	---	--------------------

	1	3666	Black Plate 1 x 6 Catalog: Parts: Plate	PG
---	---	----------------------	---	--------------------

	1	3022	Black Plate 2 x 2 Catalog: Parts: Plate	PG
---	---	----------------------	---	--------------------

	2	3020	Black Plate 2 x 4 Catalog: Parts: Plate	PG
---	---	----------------------	---	--------------------

	3	3795	Black Plate 2 x 6 Catalog: Parts: Plate	PG
---	---	----------------------	---	--------------------

	1	3032	Black Plate 4 x 6 Catalog: Parts: Plate	PG
---	---	----------------------	---	--------------------

+		1	3035	Black Plate 4 x 8 Catalog: Parts: Plate	PG
---	--	---	----------------------	---	--------------------

+		1	x88	Black Rubber Band Small (Square Cross Section) Catalog: Parts: Rubber Band & Belt	PG
---	---	---	---------------------	---	--------------------

+		2	3040a	Black Slope 45 2 x 1 - without Bottom Tube Catalog: Parts: Slope	PG
---	---	---	-----------------------	--	--------------------

+		2	3660	Black Slope, Inverted 45 2 x 2 Catalog: Parts: Slope, Inverted	PG
---	---	---	----------------------	--	--------------------

+		4	3704	Black Technic, Axle 2 Catalog: Parts: Technic, Axle	PG
---	---	---	----------------------	---	--------------------

+		5	3705	Black Technic, Axle 4 Catalog: Parts: Technic, Axle	PG
---	--	---	----------------------	---	--------------------

+		4	3706	Black Technic, Axle 6 Catalog: Parts: Technic, Axle	PG
---	---	---	----------------------	---	--------------------

+		6	3707	Black Technic, Axle 8 Catalog: Parts: Technic, Axle	PG
---	---	---	----------------------	---	--------------------

+		32	3711	Black Technic, Link Chain Catalog: Parts: Technic, Link	PG
---	---	----	----------------------	---	--------------------

+		3	3740	Black Tire 24 x 43 Technic Catalog: Parts: Tire & Tread	PG
---	---	---	----------------------	---	--------------------

+		2	3005	Blue Brick 1 x 1 Catalog: Parts: Brick	PG
---	---	---	----------------------	--	--------------------

+		4	3622	Blue Brick 1 x 3 Catalog: Parts: Brick	PG
---	---	---	----------------------	--	--------------------

+



*

8

[3010](#)

Blue Brick 1 x 4
[Catalog:](#) [Parts:](#) [Brick](#)

[PG](#)

+



*

1

[3009](#)

Blue Brick 1 x 6
[Catalog:](#) [Parts:](#) [Brick](#)

[PG](#)

+



*

6

[3008](#)

Blue Brick 1 x 8
[Catalog:](#) [Parts:](#) [Brick](#)

[PG](#)

+

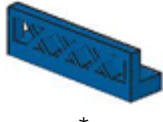

*

1

[3633](#)

Blue Fence 1 x 4 x 1
[Catalog:](#) [Parts:](#) [Fence](#)

[PG](#)

+



*

6

[3023](#)

Blue Plate 1 x 2
[Catalog:](#) [Parts:](#) [Plate](#)

[PG](#)

+

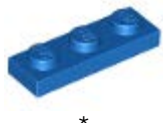

*

1

[3623](#)

Blue Plate 1 x 3
[Catalog:](#) [Parts:](#) [Plate](#)

[PG](#)

+



*

2

[3710](#)

Blue Plate 1 x 4
[Catalog:](#) [Parts:](#) [Plate](#)

[PG](#)

+



*

4

[3666](#)

Blue Plate 1 x 6
[Catalog:](#) [Parts:](#) [Plate](#)

[PG](#)

+



*

2

[3460](#)

Blue Plate 1 x 8
[Catalog:](#) [Parts:](#) [Plate](#)

[PG](#)

+



*

3

[3021](#)

Blue Plate 2 x 3
[Catalog:](#) [Parts:](#) [Plate](#)

[PG](#)

+



*

2

[3795](#)

Blue Plate 2 x 6
[Catalog:](#) [Parts:](#) [Plate](#)

[PG](#)

+













*

4

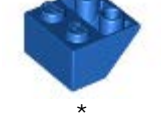
[3832](#)

Blue Plate 2 x 10
[Catalog:](#) [Parts:](#) [Plate](#)

[PG](#)

+		3	3036	Blue Plate 6 x 8 Catalog: Parts: Plate	PG
*					
+		2	3298	Blue Slope 33 3 x 2 Catalog: Parts: Slope	PG
*					
+		3	3297	Blue Slope 33 3 x 4 Catalog: Parts: Slope	PG
*					
+		4	3040a	Blue Slope 45 2 x 1 - without Bottom Tube Catalog: Parts: Slope	PG
*					
+		4	3037	Blue Slope 45 2 x 4 Catalog: Parts: Slope	PG
*					
+		8	3660	Blue Slope, Inverted 45 2 x 2 Catalog: Parts: Slope, Inverted	PG
*					
+		8	3700	Blue Technic, Brick 1 x 2 with Hole Catalog: Parts: Technic, Brick	PG
*					
+		3	3701	Blue Technic, Brick 1 x 4 with Holes Catalog: Parts: Technic, Brick	PG
*					
+		2	3894	Blue Technic, Brick 1 x 6 with Holes Catalog: Parts: Technic, Brick	PG
*					
+		4	3702	Blue Technic, Brick 1 x 8 with Holes Catalog: Parts: Technic, Brick	PG
*					
+		4	3895	Blue Technic, Brick 1 x 12 with Holes Catalog: Parts: Technic, Brick	PG
*					
+		4	3703	Blue Technic, Brick 1 x 16 with Holes Catalog: Parts: Technic, Brick	PG
*					

+	 *	5	3709b	Blue Technic, Plate 2 x 4 with 3 Holes Catalog: Parts: Technic, Plate	PG
---	---	---	-----------------------	---	--------------------

+	 *	2	3738	Blue Technic, Plate 2 x 8 with 7 Holes Catalog: Parts: Technic, Plate	PG
---	--	---	----------------------	---	--------------------

+	 *	2	3937	Light Gray Hinge Brick 1 x 2 Base Catalog: Parts: Hinge	PG
---	--	---	----------------------	---	--------------------

+	 *	2	3938	Light Gray Hinge Brick 1 x 2 Top Plate Thin Catalog: Parts: Hinge	PG
---	--	---	----------------------	---	--------------------

+	 *	1	3149c01 (inv)	Light Gray Hinge Plate 2 x 5 - Complete Assembly Catalog: Parts: Hinge	PG
---	--	---	-------------------------------	--	--------------------

+	 *	2	3900	Light Gray Minifig, Utensil Signal Paddle Catalog: Parts: Minifig, Utensil	PG
---	---	---	----------------------	--	--------------------

+	 *	8	3023	Light Gray Plate 1 x 2 Catalog: Parts: Plate	PG
---	--	---	----------------------	--	--------------------











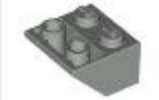

+	 *	9	3710	Light Gray Plate 1 x 4 Catalog: Parts: Plate	PG
---	--	---	----------------------	--	--------------------

+	 *	11	3666	Light Gray Plate 1 x 6 Catalog: Parts: Plate	PG
---	--	----	----------------------	--	--------------------

+	 *	15	3022	Light Gray Plate 2 x 2 Catalog: Parts: Plate	PG
---	--	----	----------------------	--	--------------------

+	 *	2	3021	Light Gray Plate 2 x 3 Catalog: Parts: Plate	PG
---	--	---	----------------------	--	--------------------

+	 *	9	3020	Light Gray Plate 2 x 4 Catalog: Parts: Plate	PG
---	--	---	----------------------	--	--------------------

+	 *	8	3795	Light Gray Plate 2 x 6 Catalog: Parts: Plate	PG
+	 *	1	3031	Light Gray Plate 4 x 4 Catalog: Parts: Plate	PG
+	 *	1	3032	Light Gray Plate 4 x 6 Catalog: Parts: Plate	PG
+	 *	1	3039	Light Gray Slope 45 2 x 2 Catalog: Parts: Slope	PG
+	 *	3	3660	Light Gray Slope, Inverted 45 2 x 2 Catalog: Parts: Slope, Inverted	PG
+	 *	20	3713	Light Gray Technic Bush Catalog: Parts: Technic	PG
+	 *	1	3652	Light Gray Technic Engine Piston Square 2 x 2 - Old Catalog: Parts: Technic	PG
+	 *	16	3651	Light Gray Technic, Axle and Pin Connector Catalog: Parts: Technic, Connector	PG
+	 *	2	3749	Light Gray Technic, Axle Pin without Friction Ridges Lengthwise Catalog: Parts: Technic, Axle	PG
+	 *	2	3647	Light Gray Technic, Gear 8 Tooth Type 1 Catalog: Parts: Technic, Gear	PG
+	 *	4	4019	Light Gray Technic, Gear 16 Tooth (Old Style with Round Holes) Catalog: Parts: Technic, Gear	PG
+	 *	4	x187	Light Gray Technic, Gear 24 Tooth (Old Style with Three Axle Holes) Catalog: Parts: Technic, Gear	PG

+	 *	1	3649	Light Gray Technic, Gear 40 Tooth Catalog: Parts: Technic, Gear	PG
---	---	---	----------------------	---	--------------------

+	 *	20	3673	Light Gray Technic, Pin without Friction Ridges Lengthwise Catalog: Parts: Technic, Pin	PG
---	--	----	----------------------	---	--------------------

+	 *	3	3739	Light Gray Wheel 24 x 43 Technic Catalog: Parts: Wheel	PG
---	--	---	----------------------	--	--------------------

+	 *	2	3005	Red Brick 1 x 1 Catalog: Parts: Brick	PG
---	--	---	----------------------	---	--------------------

+	 *	2	3004	Red Brick 1 x 2 Catalog: Parts: Brick	PG
---	--	---	----------------------	---	--------------------

+	 *	2	3010	Red Brick 1 x 4 Catalog: Parts: Brick	PG
---	---	---	----------------------	---	--------------------

+	 *	2	3003old	Red Brick 2 x 2 without Inside Supports Catalog: Parts: Brick	PG
---	--	---	-------------------------	---	--------------------

+	 *	4	3024	Red Plate 1 x 1 Catalog: Parts: Plate	PG
---	--	---	----------------------	---	--------------------

+	 *	4	3623	Red Plate 1 x 3 Catalog: Parts: Plate	PG
---	--	---	----------------------	---	--------------------

+	 *	6	3666	Red Plate 1 x 6 Catalog: Parts: Plate	PG
---	--	---	----------------------	---	--------------------

+	 *	3	3460	Red Plate 1 x 8 Catalog: Parts: Plate	PG
---	--	---	----------------------	---	--------------------

+	 *	3	3022	Red Plate 2 x 2 Catalog: Parts: Plate	PG
---	--	---	----------------------	---	--------------------

+		2	3021	Red Plate 2 x 3 Catalog: Parts: Plate	PG
---	--	---	----------------------	---	--------------------

*

+		1	3795	Red Plate 2 x 6 Catalog: Parts: Plate	PG
---	---	---	----------------------	---	--------------------

*

+		1	3031	Red Plate 4 x 4 Catalog: Parts: Plate	PG
---	---	---	----------------------	---	--------------------

*

+		1	3032	Red Plate 4 x 6 Catalog: Parts: Plate	PG
---	---	---	----------------------	---	--------------------

*

+		1	3035	Red Plate 4 x 8 Catalog: Parts: Plate	PG
---	---	---	----------------------	---	--------------------

*

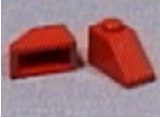
+		6	3040a	Red Slope 45 2 x 1 - without Bottom Tube Catalog: Parts: Slope	PG
---	---	---	-----------------------	--	--------------------

*

+		8	3665	Red Slope, Inverted 45 2 x 1 Catalog: Parts: Slope, Inverted	PG
---	---	---	----------------------	--	--------------------

*

+		1	3065	Trans-Red Brick 1 x 2 without Bottom Tube Catalog: Parts: Brick	PG
---	---	---	----------------------	---	--------------------

*

+		2	3024	Trans-Red Plate 1 x 1 Catalog: Parts: Plate	PG
---	---	---	----------------------	---	--------------------

*

+		2	3065	Trans-Yellow Brick 1 x 2 without Bottom Tube Catalog: Parts: Brick	PG
---	---	---	----------------------	--	--------------------

*

Extra Items:

+		1	x88	Black Rubber Band Small (Square Cross Section) Catalog: Parts: Rubber Band & Belt	PG
---	---	---	---------------------	---	--------------------

*

+		1	3711	Black Technic, Link Chain Catalog: Parts: Technic, Link	PG
---	--	---	----------------------	---	--------------------



*

+



*

1

[3900](#)**Light Gray Minifig, Utensil Signal Paddle**[Catalog: Parts: Minifig, Utensil](#)[PG](#)

+



*

1

[3647](#)**Light Gray Technic, Gear 8 Tooth Type 1**[Catalog: Parts: Technic, Gear](#)[PG](#)

+



*

1

[3024](#)**Trans-Red Plate 1 x 1**[Catalog: Parts: Plate](#)[PG](#)**Counterparts:**

+



*

3

[3739c01\(inv\)](#)**Light Gray Wheel 24 x 43 Technic with Black Tire 24 x 43 Technic (3739 / 3740)**[Catalog: Parts: Wheel & Tire Assembly](#)[PG](#)**Summary:**

Type	Unique Lots	Total Qty
Regular Items:		
Parts	93	410
Extra Items:		
Parts	5	5
Counterparts:		
Parts	1	3

Source:

Parts List

[jimmy_sto \(108\)](#) inventoried this Set on Nov 25, 2006, inventory last updated on Mar 26, 2018.